



FLYERS OF THE DARK MILLENNIUM



CONTENTS

INTRODUCTION	3	Black Legion Wing Leaders: Anointed	22	Hemlock Wraithfighters: Iyanden Craftworld	53
SPACE MARINES	4	Chaos Legions and Warbands	24	Hemlock Wraithfighters: Ulthwé Craftworld	54
Ultramarines Aces: Adamantine Wings	4	NECRONS	28	Hemlock Wraithfighters: Alaitoc Craftworld	55
Ultramarines Wing Leaders	6	Sautekh Dynasty Aces: Lordsblades.....	28	Hemlock Wraithfighters: Biel-Tan Craftworld	56
Ultramarines Storm Wing.....	8	Sautekh Dynasty Flights and Flight Leaders	30	Hemlock Wraithfighters: Minor Craftworlds and Corsair Raiders.....	57
Ultramarines Squadron Markings.....	9	Mephrit Dynasty.....	34	ORKS	58
White Scars and Salamanders.....	10	Novokh Dynasty.....	35	Goff Aces: Flybosses.....	58
Raven Guard and Imperial Fists	11	Charnovokh and Nihilakh Dynasties	36	Goffs	60
Crimson Fists and Black Templars	12	Throkt and Nephrekh Dynasties	37	Bad Moons	62
Iron Hands and Hawk Lords	13	TAU EMPIRE	38	Evil Sunz	64
Successor Chapters	14	Tau Sept Aces: Y’eldi	38	Deathskulls.....	66
BLOOD ANGELS	15	Tau Sept	40	Blood Axes	67
SPACE WOLVES	16	Vior’la Sept	42	AERONAUTICA IMPERIALIS	68
GREY KNIGHTS	17	Sa’cea Sept	43	Valkyries	68
DARK ANGELS	18	Farsight Enclaves.....	44	Militarum Tempestus Valkyries.....	72
CHAOS SPACE MARINES	20	Other Septs	45	DARK ELDAR	74
Black Legion Aces: Helscourges.....	20	CRAFTWORLD ELDAR	48	Black Heart Kabal Aces	74
		Crimson Hunter Aspect Warriors:		Dark Eldar Kabals.....	76
		The Hawks of Kurnous	48	Kabals, Wych Cults and Covens	78
		Hemlock Wraithfighters: Saim-Hann Craftworld.....	52		

PRODUCED BY GAMES WORKSHOP IN NOTTINGHAM

Flyers of the Dark Millennium © Copyright Games Workshop Limited 2016. Flyers of the Dark Millennium, GW, Games Workshop, Space Marine, 40K, Warhammer, Warhammer 40,000, the 'Aquila' Double-headed Eagle logo, and all associated logos, illustrations, images, names, creatures, races, vehicles, locations, weapons, characters, and the distinctive likenesses thereof, are either ® or TM, and/or © Games Workshop Limited, variably registered around the world. All Rights Reserved.

No part of this publication may be reproduced, stored in a retrieval system, or transmitted in any form or by any means, electronic, mechanical, photocopying, recording or otherwise, without the prior permission of the publishers.

Printed by C&C in China

INTRODUCTION

Cast your gaze up to the stratosphere and listen hard. There, high above the desolate, shattered terrain of the dark and distant future, echoes the roar of powerful engines and the staccato thunder of awesome weapons.

Narrowing your eyes, you focus upon a vast weave of vapour trails, spirals clearly visible against the cold cerulean tapestry. These are the ethereal paths that mark the way to victory and honour, or to a sudden and fiery death.

FLYERS OF THE DARK MILLENNIUM

This book provides a rich and detailed guide to the liveries and insignia found on aircraft of the 41st Millennium. On the following pages you will find hundreds of colour profiles, squadron markings and Ace badges illustrating the diverse ways in which pilots and their craft are arrayed for war, along with in-depth information on the history and battle roles of these formidable war machines.



SPACE MARINES

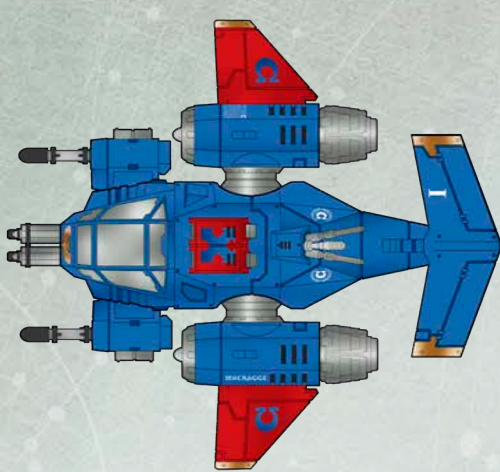

This Stormtalon Gunship is piloted by Techmarine Galion, veteran dogfighter and vaunted hero of the last battle over Erkingol Hive.

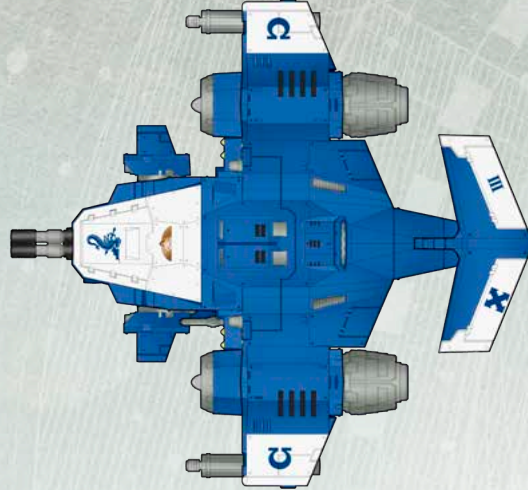

Piloted by Techmarine Ascellius, this Stormhawk Interceptor is named *Gladius Maximal* and saw service during the Second Tyrannic War.

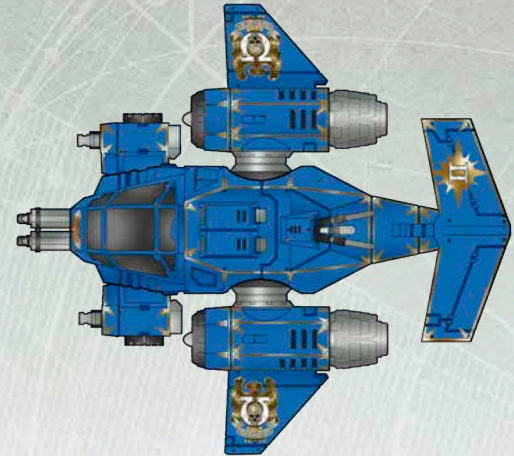

Gloriam Eagle has the honour of being one of two Stormtalon Gunships assigned to escort Chapter Master Marneus Calgar's Thunderhawk.

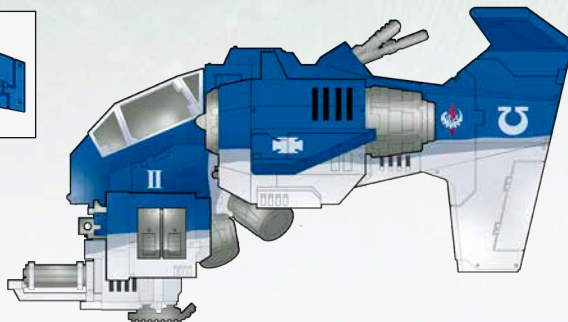
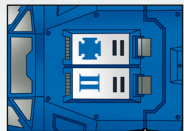

This Stormtalon was piloted by Techmarine Phaetorian in battle against the Tyranids on Morus. Its white underbelly acts as camouflage in snowy conditions.

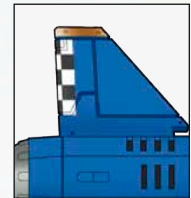
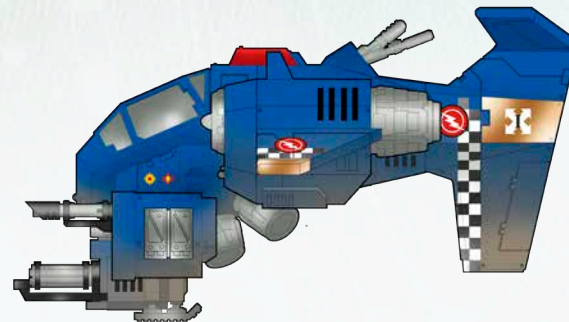

The much-decorated Stormtalon Gunship of Techmarine Dronichus, *Herculean* has survived some of the most punishing war zones in the galaxy.

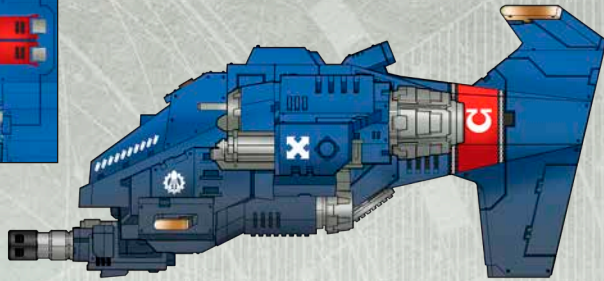
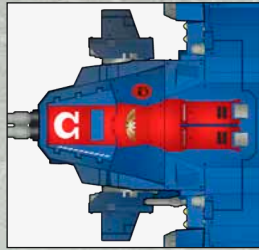

This Stormhawk Interceptor is flown by Techmarine Vaestus, who shot down the infamous Grey Ghost of Ithil in a one-on-one dogfight.

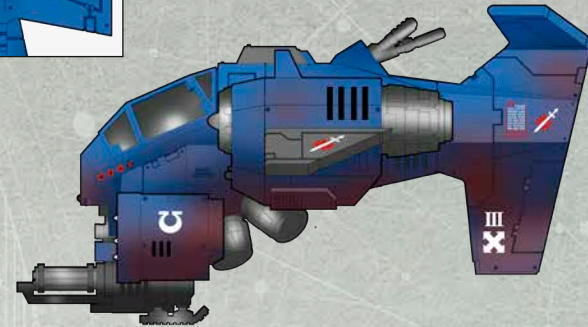
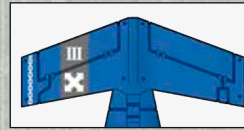

Glory Eternal is a Stormtalon Gunship that has seen savage battle over the red deserts of Ghamor, holding back the winged horrors of the Tyranid splinter fleets.

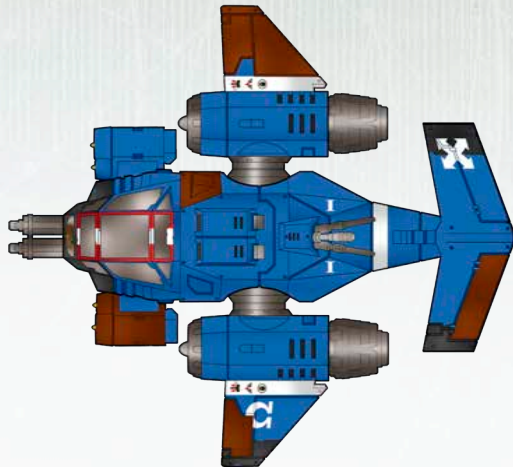

The unpainted panels on this Stormtalon Gunship show where hurried repairs were made by its Techmarine pilot so as to swiftly rejoin the fight.

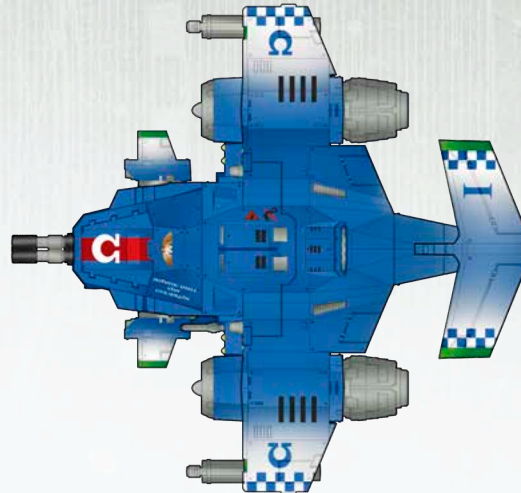

This Stormhawk Interceptor is named *Unrelenting*, and brought down no less than three enemy Aces during the Ghoddokk Purge.

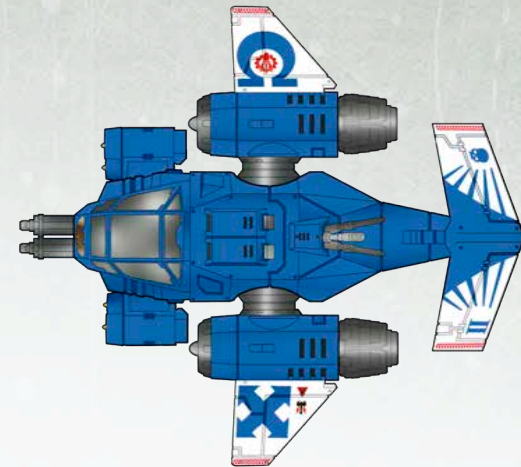

The elaborate iconography and decorative artifice on this Stormtalon Gunship mark it out as the craft of strike force commander Techmarine Garnus.

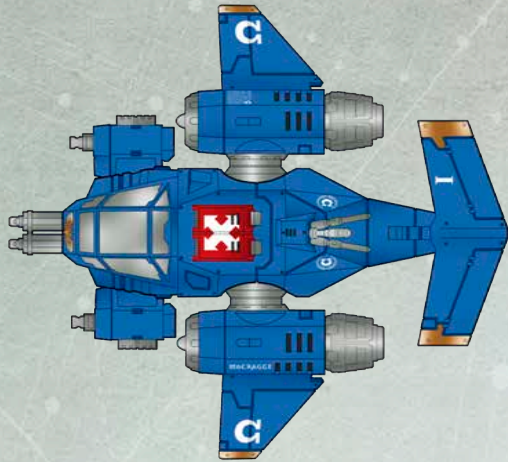

Wing leader of Stormtalon Squadron 'Guilliman's Thunder', status denoted by red panelling

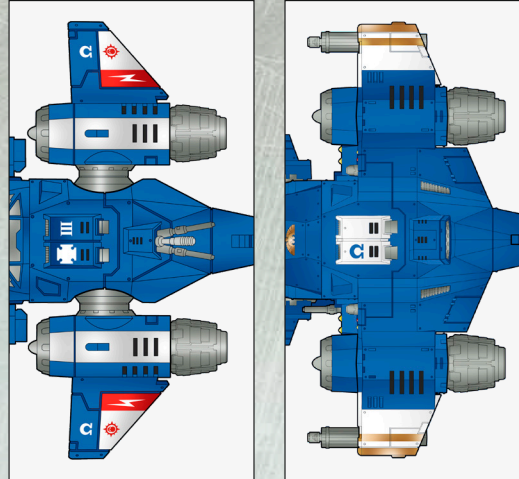

The red and white panels on these wing tips and cowlings mark out squadron leaders.

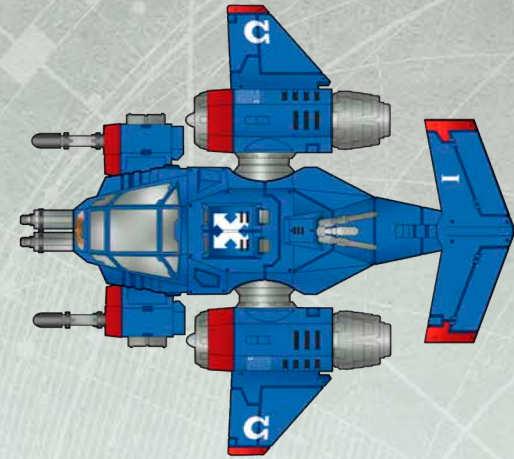

This Stormtalon is marked as its squadron's leader by the extensive red panelling upon cowlings and wings.

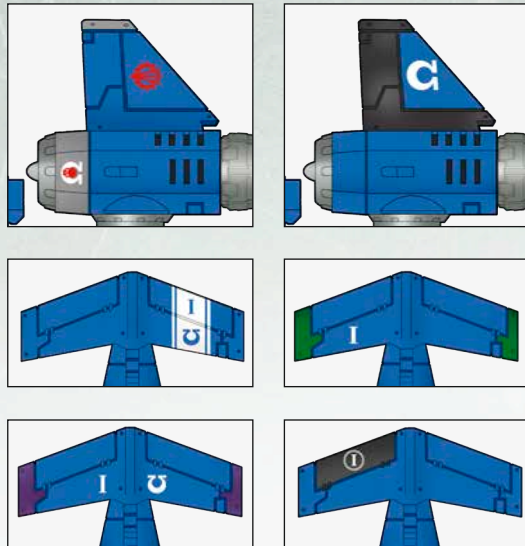

Above are examples of tail-fin and wing designs that mark out Ultramarines squadron leaders.

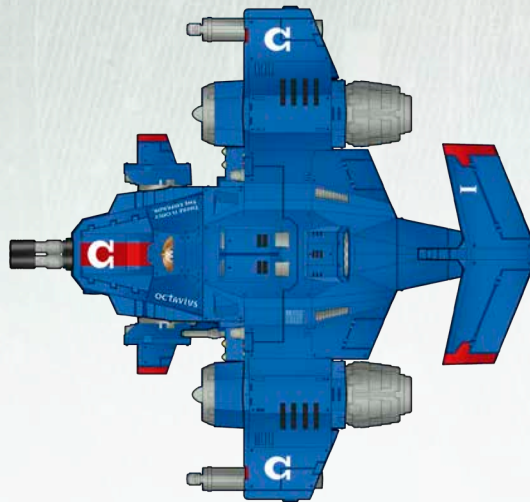

Stormhawk of Squadron Leader Cebarus, marked out by red panels and canopy stripe

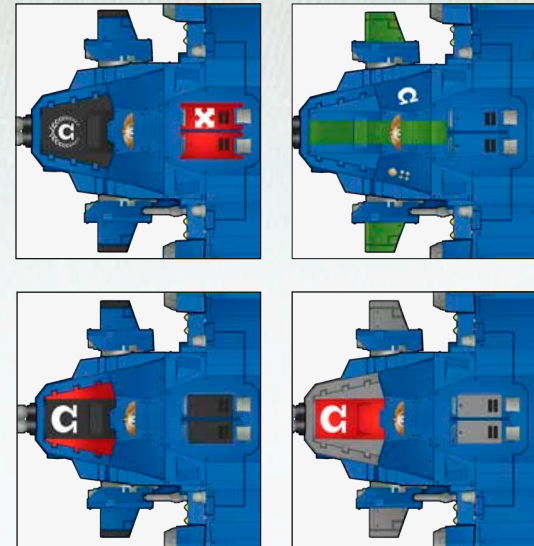

Many Stormhawk wing leaders are marked out by the use of coloured canopy designs and banding.

HONOUR MARKINGS



Here can be seen a wide variety of the honour markings inscribed upon Space Marine aircraft to celebrate great deeds.

CAMPAIGN BADGES



Space Marine vehicles that take part in notable campaigns are marked with unique campaign badges. Their aircraft are no exception to this.

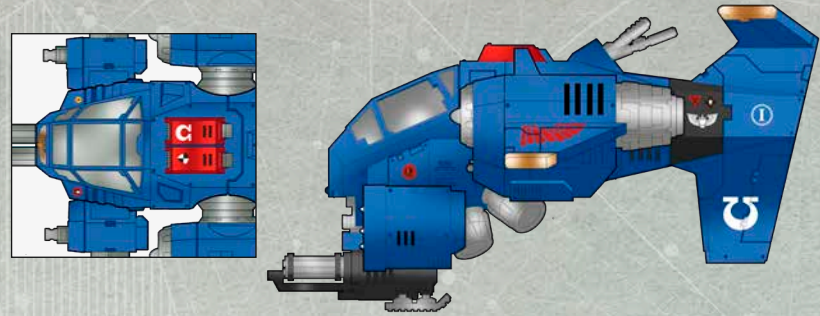

This Stormtalon, *Primarch's Blade*, bears multiple honour and kill markings upon its tail and cowling.

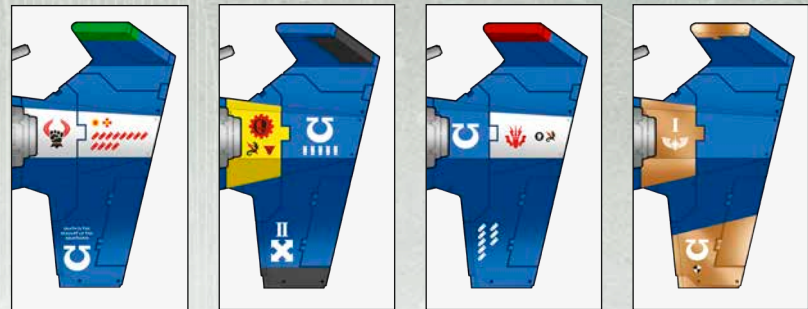

The images above depict examples of honour and kill markings such as the Gauntlet of Heroes, the Crest Mechanicum and the Wings of Honour.

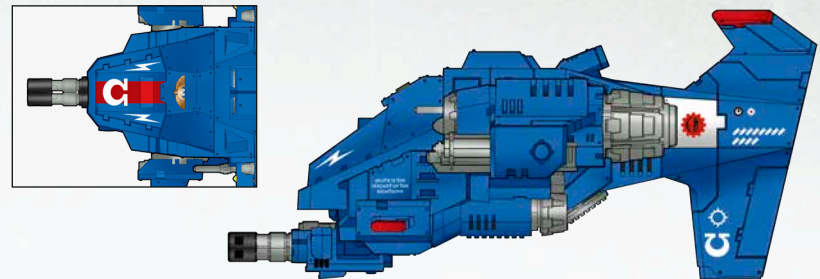

This Stormhawk Interceptor bears an impressive tally of kill markings upon its tail assembly, alongside the Crest Mechanicum and the Firefall campaign badge.

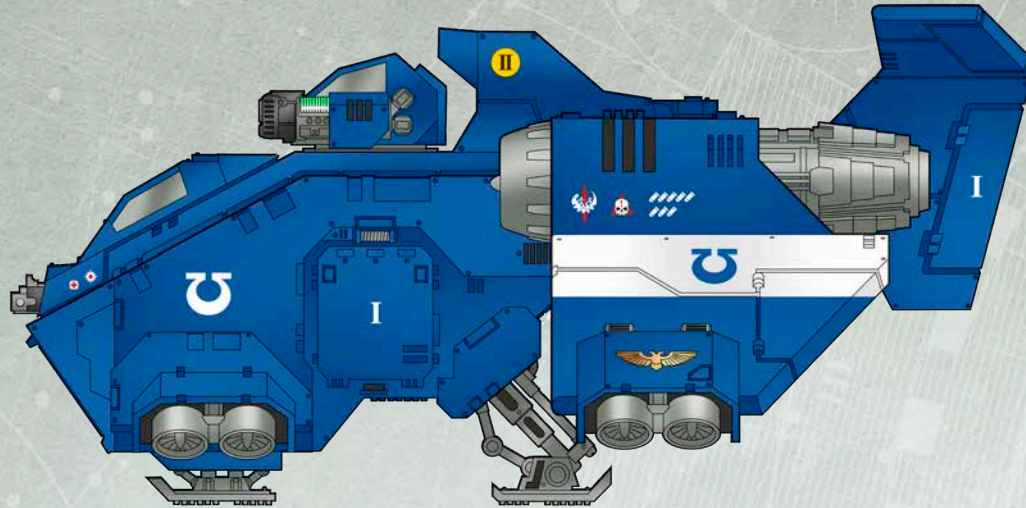

Seen here is a Storm Wing: one Stormraven Gunship escorted by two Stormtalons. They are linked by their iconography and squadron numbering, while their markings show they are attached to the 2nd Company.

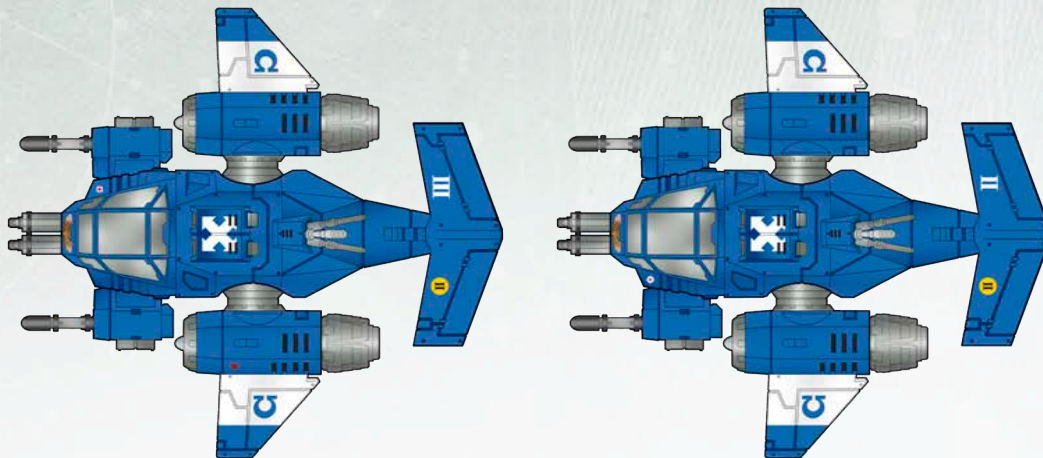

Each craft in Storm Wing 'Hammer of Ultramar' is marked with distinctive white-stripe patterning that serves to easily identify them as a single formation.

KILL MARKINGS



Here can be seen a number of examples of kill markings utilised by Space Marine Chapters. In many cases, smaller shells, crosses or skulls will be applied for individual kills, while larger versions of the same design denote a multitude of enemies slain.

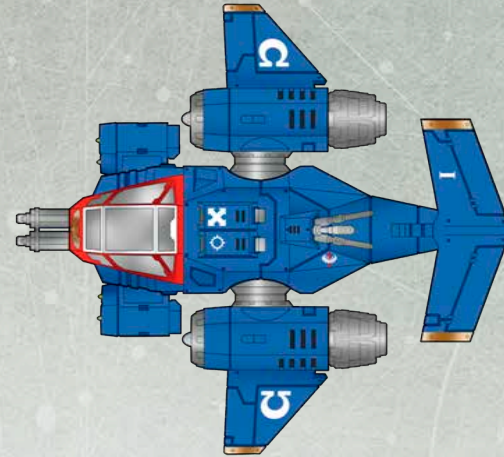
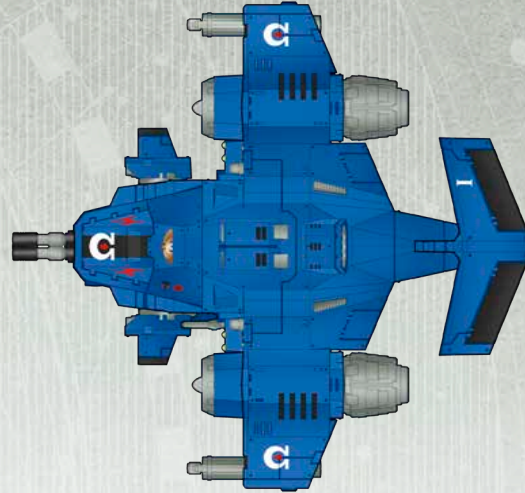
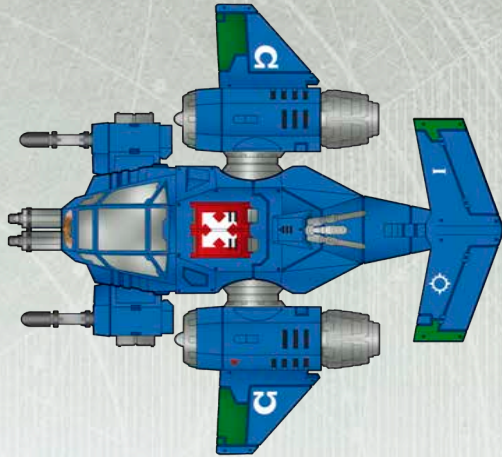
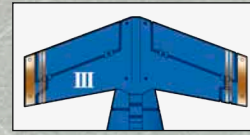
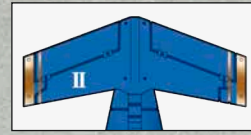
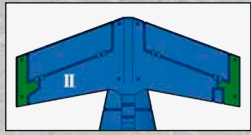

This Stormtalon belongs to 'Firestorm' Squadron, indicated by its green wing markings.

The black panels on this Stormhawk's tail signify its squadron. Note the Ace markings on the canopy.

This Stormtalon Squadron is identified by the gold bars on its wing-tips and tail assembly.

I II III IV V
VI VII VIII IX X
1 2 3 4 5
6 7 8 9 10

Many Space Marine Chapters use numerals or number markings to denote individual craft within their squadrons.

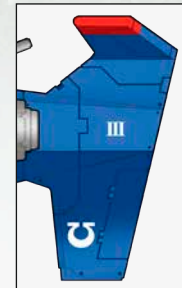
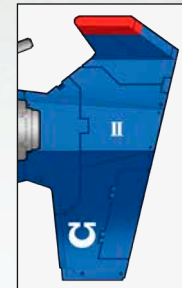
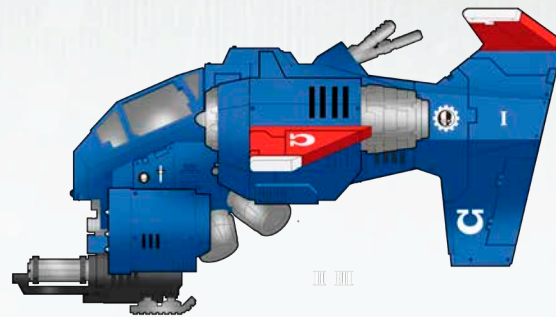

The tail numerals show the first, second and third craft of Ultramarines Stormtalon Gunship Squadron 'Adamant'.

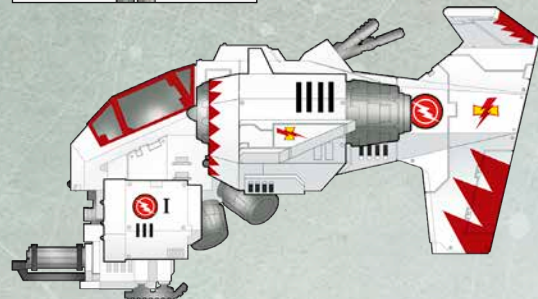
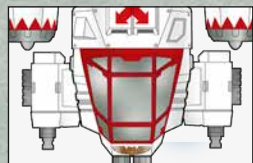

The Stormtalon of Squadron Leader Jaghai is denoted by its red canopy. Squadron markings appear on the tail, the craft number on its weapon cowlings.

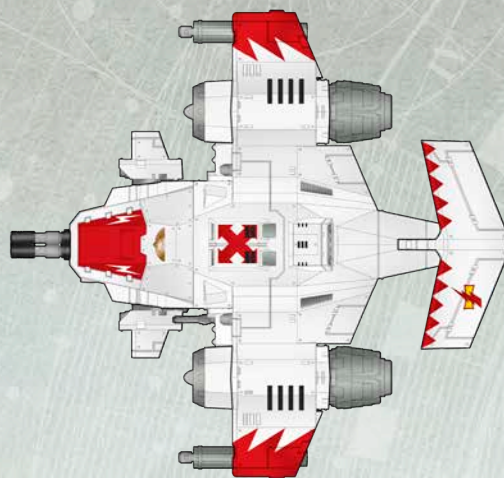

This Stormhawk is shown to be a member of 'Plainshawks' Squadron by its jagged tribal markings.

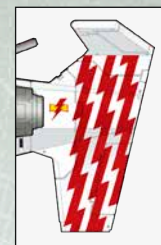
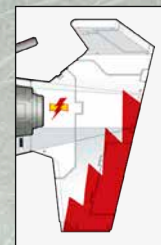

The White Scars use vivid red jags and stylised lightning bolts to mark out their aircraft squadrons.

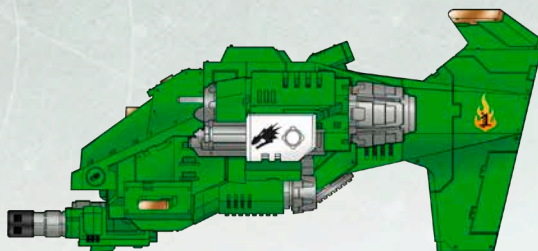

This Salamanders squadron leader, the Stormhawk *Vulkan's Eye*, is designated by its gold tail bar.

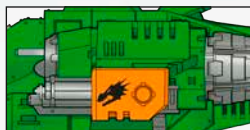
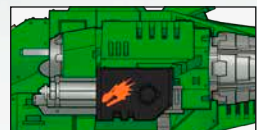

Differently coloured weapon cowlings often denote Salamanders aircraft squadrons.

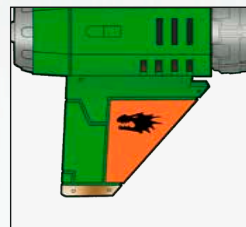
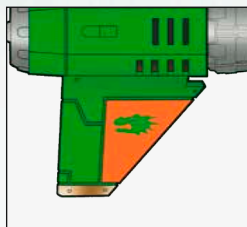
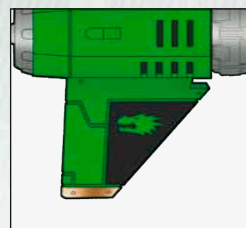
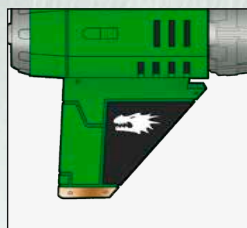

A number of variant squadron markings hailing from some of the Salamanders' most honoured wings

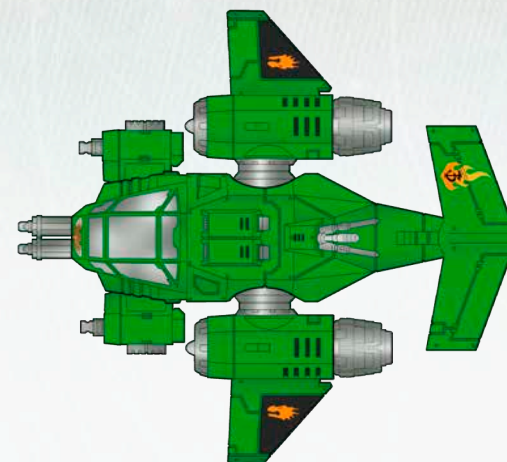

Stormtalon *Volcanic* of Squadron Vultus. Techmarine Vultus' own craft is denoted by gold wing tips.

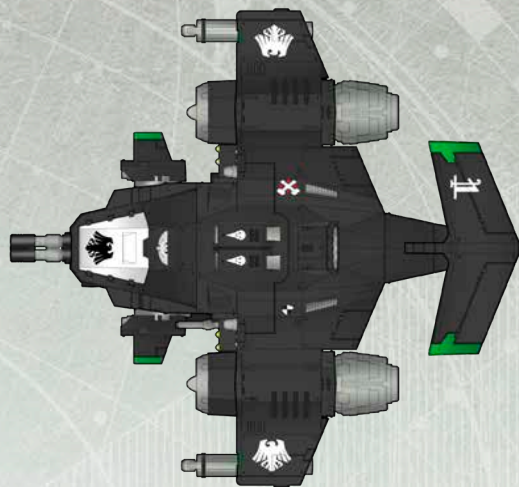

Squadron Leader Kyrolius, attached to the 4th Company as shown by green squadron markings

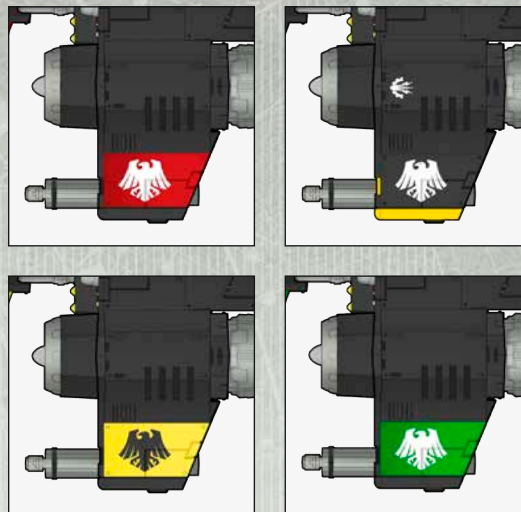

The Raven Guard often mark out their squadrons with coloured bars upon the wings of the craft.

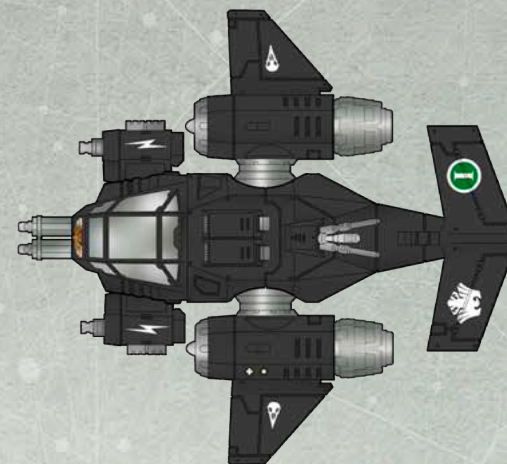

This Stormtalon, *Silent Slayer*, bears the Corvine Skull honour markings upon its wings.

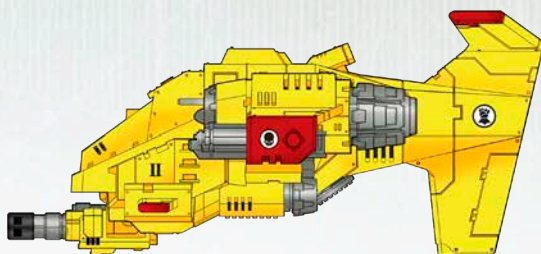

Imperial Fists Stormhawk Interceptor of Squadron Pevros. Note kill markings from the Dortus Cleansing.

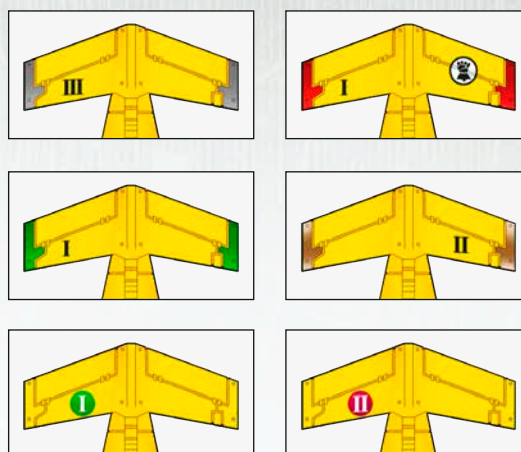

Many Imperial Fists squadrons are denoted by coloured bars or roundels upon their tails and on the tips of their wings.

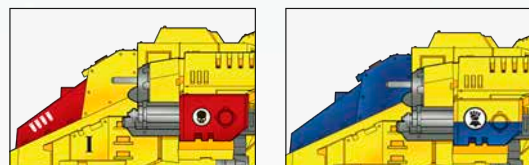

Variant Imperial Fists squadron markings

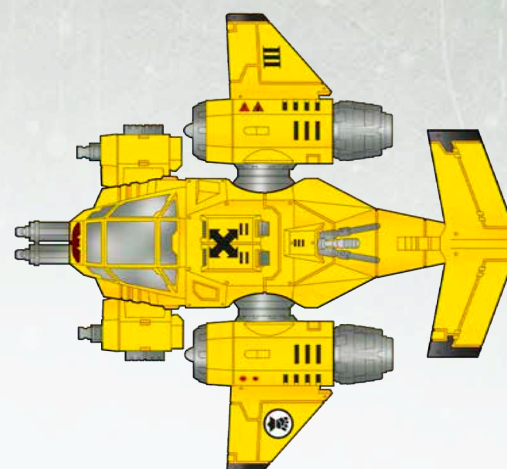

The craft of Squadron Lasaladus bear the assault symbol, displayed to reflect their aggressive role.

RAVEN GUARD AND IMPERIAL FISTS

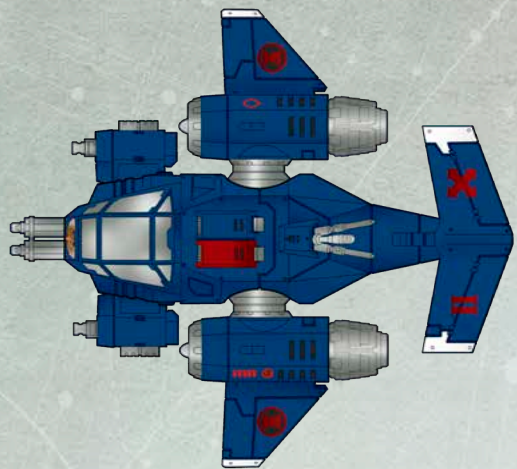

This Stormtalon is denoted as part of Squadron Hadronius by the single red cowling panel.

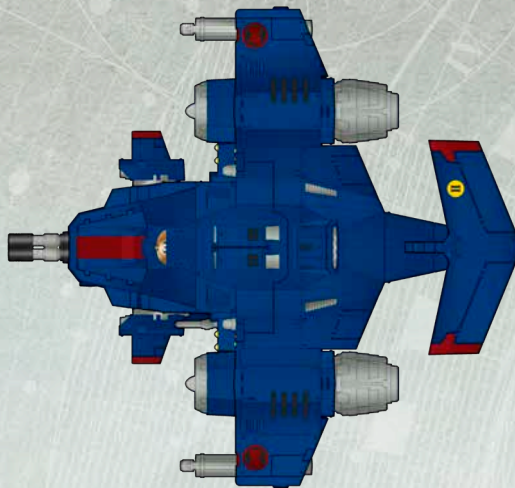

Pictured here is the Stormhawk *Vengeance for All*, marked out as attached to the 2nd Company.

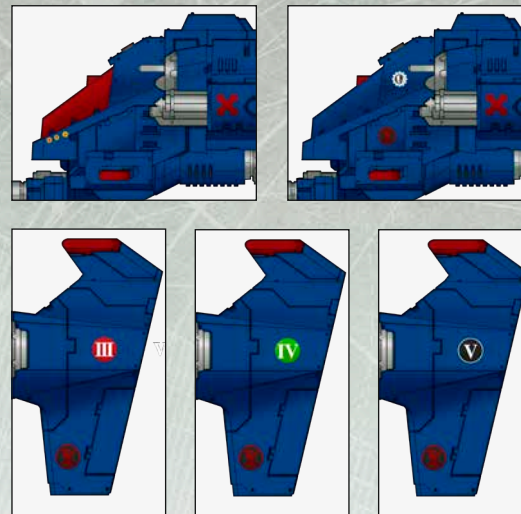

Coloured roundels containing numerals may be used when a craft is attached to a specific company.

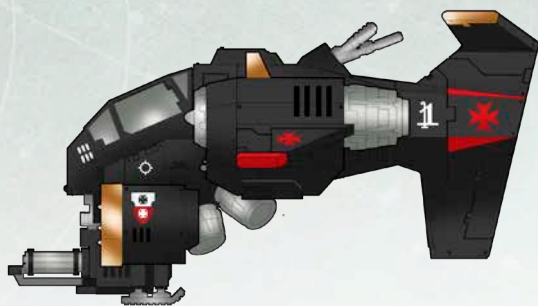

Techmarine Gorlaen is identified by gold panels and a red Chapter icon on his craft, echoing the markings of the Black Templars' veteran Sword Brothers.



These tails designs are squadron markings; the red cross denotes the wing's leader.



A selection of Black Templars badges showing which crusade the craft is part of

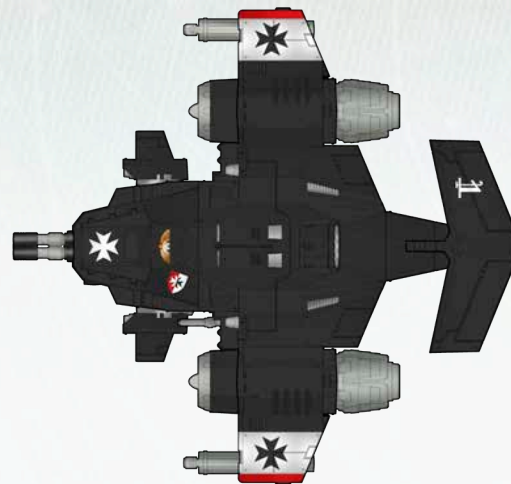

Intolerance Justificus, the Stormhawk Interceptor of Wing Leader Bellicoriphon of the Black Templars



Piloted by Iron Father Gervos, this Stormhawk shows its wing leader status with a silver canopy and tail fin.



These markings show the Clan Company each craft is assigned to –these are Clans Raukaan and Haarmek.

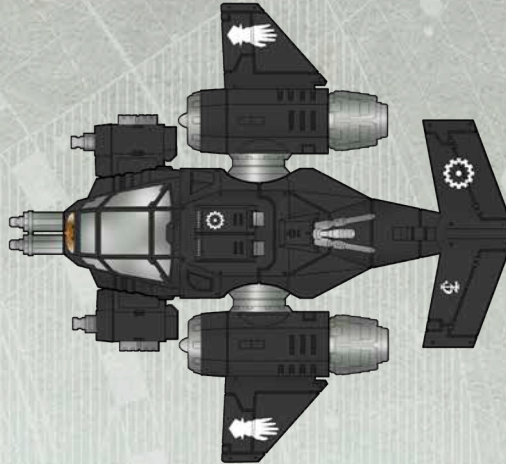

This Stormtalon bears the Iron Hands icon on its wings, and the emblem of Clan Kaargul on its tail.

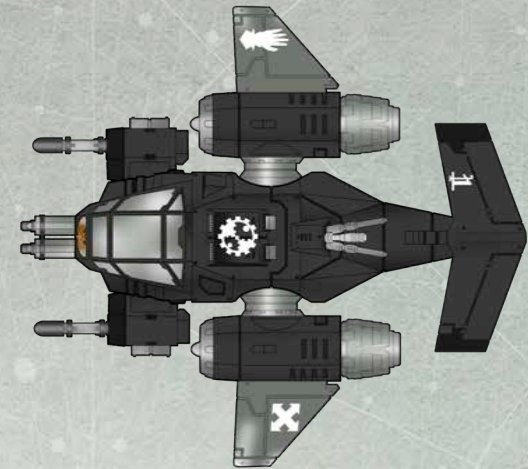

The Stormtalon Gunship of Techmarine Vaargal of the Clan Morlaag, who flew in the last attack on Vridium.

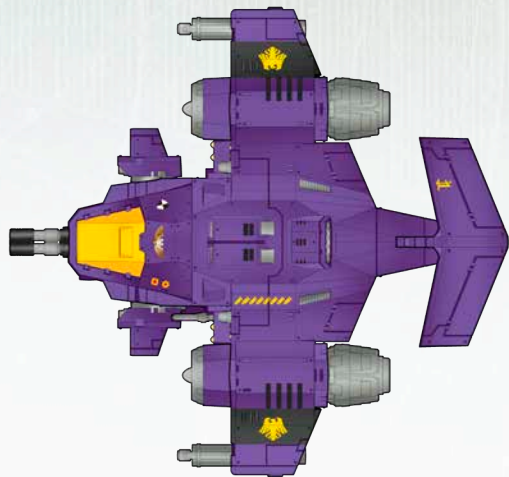

The Hawk Lords are noted as exceptional pilots, as shown by the kill tally on this Stormhawk's hull.

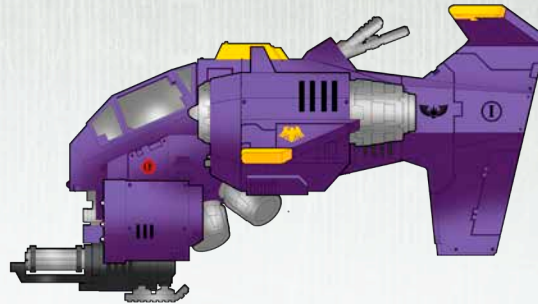

Bladefather, the Stormtalon Gunship of the famous Hawk Lords Techmarine Vandrael



Examples of Hawk Lords squadron markings on the tail assemblies of their aircraft

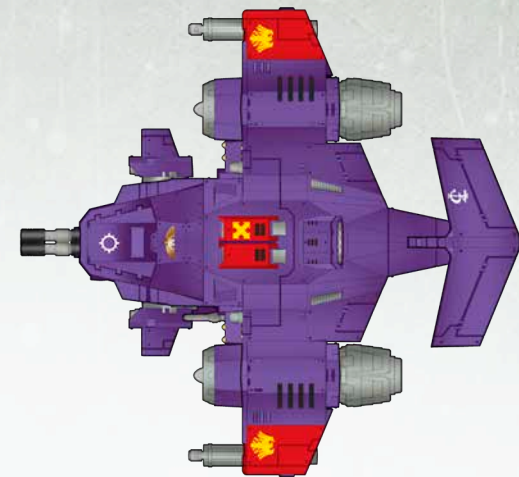

This Hawk Lords Stormhawk survived the ambush on Nebulum and shot down many Ork attackers.

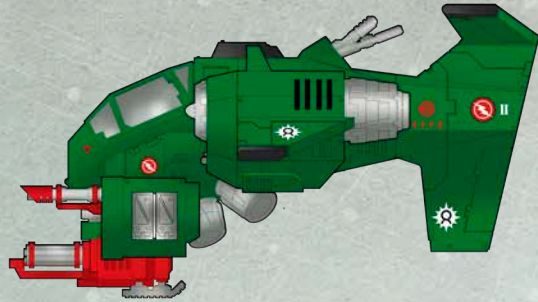

Resolute, a Stormtalon of the Aurora Chapter, displays an impressive array of honour markings.

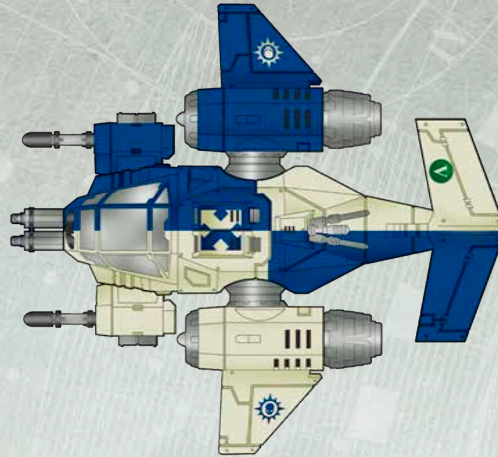

This is *Ulixis Rex*, an ancient and greatly honoured Stormtalon Gunship of the Novamarines.

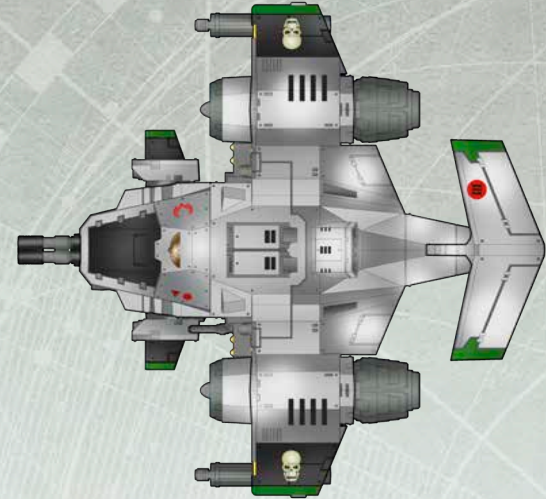

The Doom Legion are well known for extensive use of Stormhawk Interceptors to eliminate their foes.

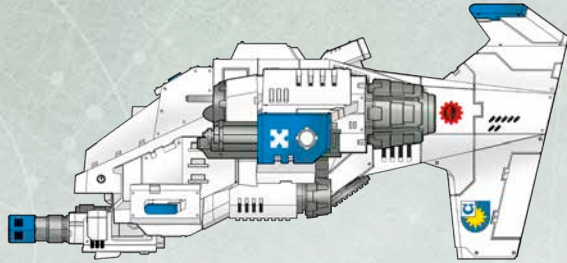

This Stormhawk, *Righteous Wrath*, belongs to the Praetors of Orpheus Space Marine Chapter.

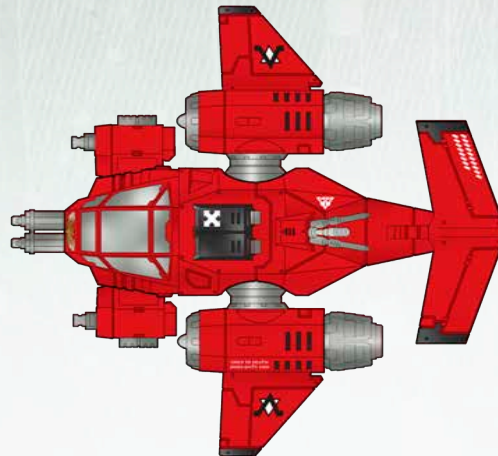

A Stormtalon Gunship of the Genesis Chapter with a heroic tally of enemy aircraft kills marked on its tail.

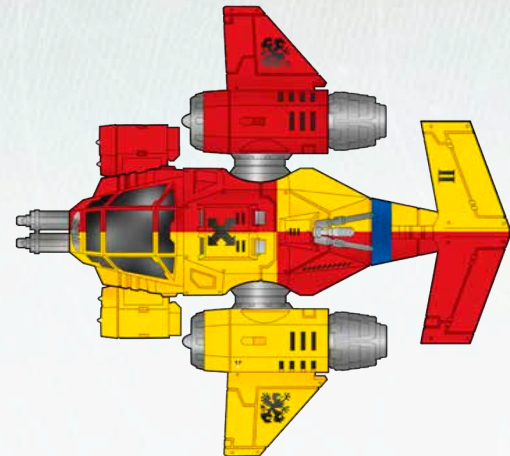

Stormtalon Gunship *Talon of Intolerance*, piloted by Techmarine Vastus of the Howling Griffons

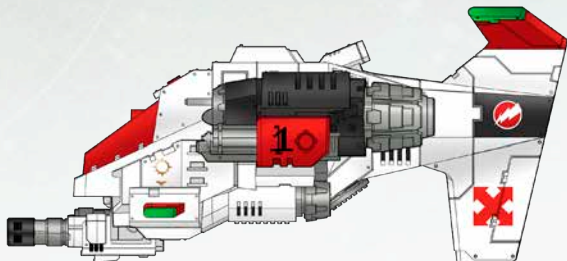

Signified as wing leader by its red cockpit marking, this Stormhawk belongs to the Black Guard Chapter.

BLOOD ANGELS

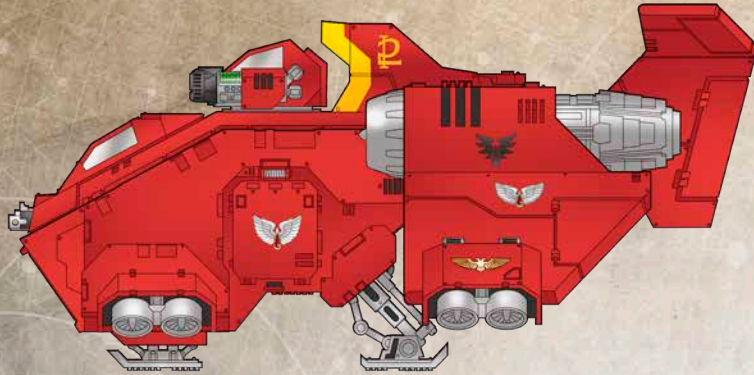

Stormraven Gunship *Honour of Baal*, part of Squadron Caephos. This squadron fought over Jaegus City, and bears dorsal squadron markings as shown.

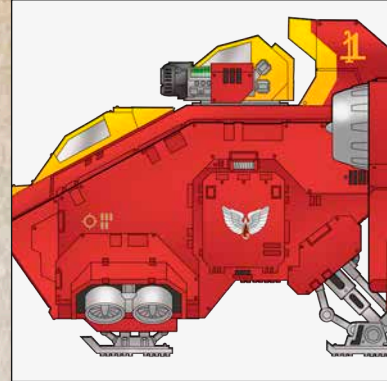

The Blood Angels often denote squadron leaders with yellow canopies.

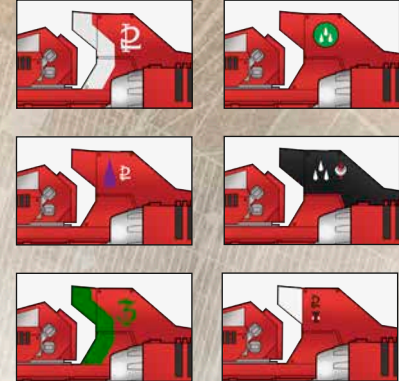

Variant Blood Angels squadron markings on dorsal fins

Variations on the blood drop sigil are frequently used to designate Blood Angels squadrons.

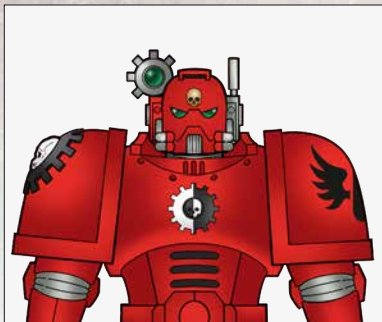

Techmarine gunship pilot Brother Vernallis of Squadron Phaestos

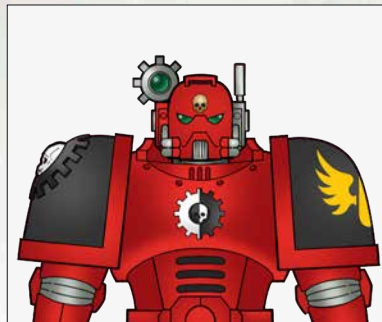

Squadron Leader Phaestos bears a yellow Chapter icon on a black field.

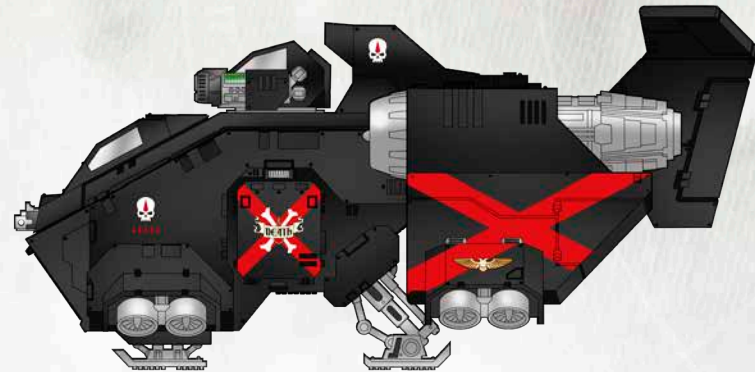

The black and red Stormravens of the Death Company are instantly recognisable. The pilot of *Mortifex* displays a formidable kill tally beneath his cockpit window.

SPACE WOLVES

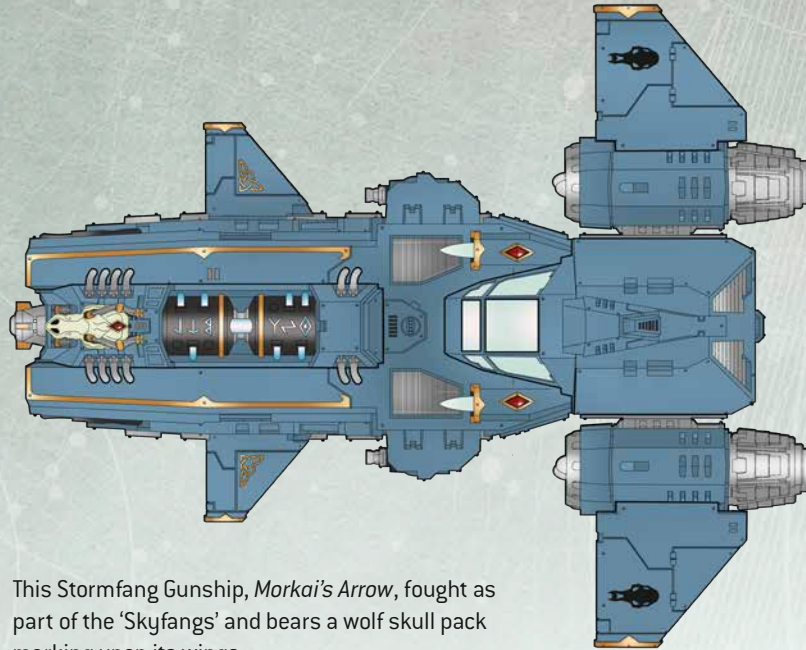

This Stormfang Gunship, *Morkai's Arrow*, fought as part of the 'Skyfangs' and bears a wolf skull pack marking upon its wings.

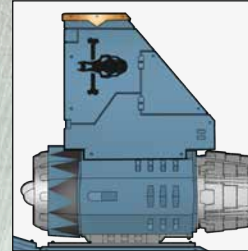

The pack leader of the 'Skyfangs' bears a more elaborate version of the wolf skull pack marking, as depicted here.



Above are a selection of typical Space Wolf aircraft pack markings, from the fangs of the storm to the gaze of Morkai.

1 2 3 4

Fenrisian runic numerals are typically used to distinguish each individual aircraft within a pack.

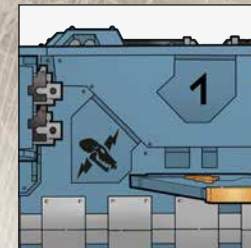
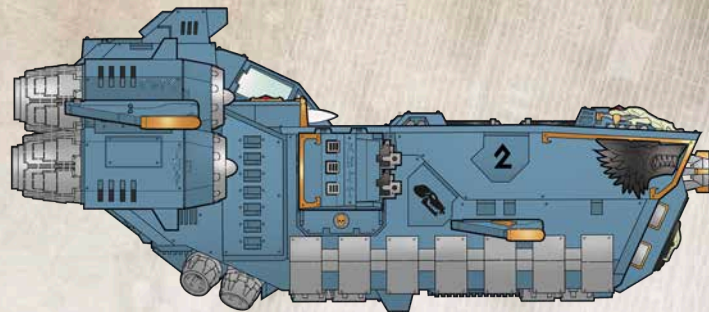
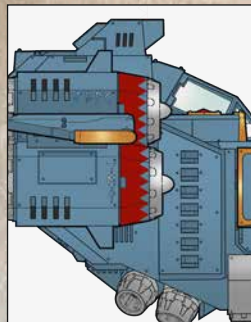

A pair of Stormfang Gunships from the 'Wrath of Fenris'. Note the additional red markings on the pack leader's engine intakes, and his more ornate pack marking.

GREY KNIGHTS

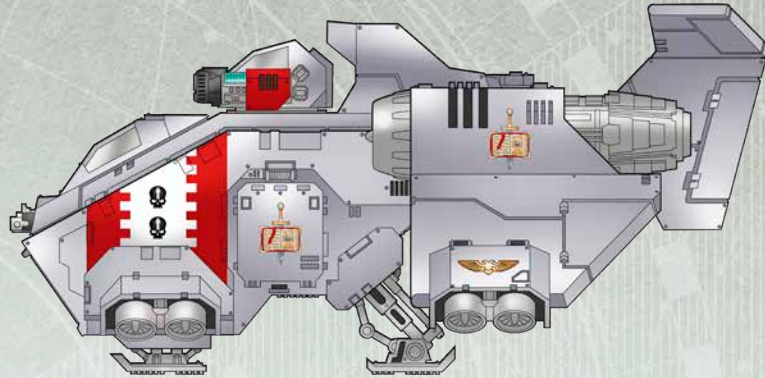

This Stormraven, *Light of Banishment*, is flown by Techmarine Pilot Asteron, whose heraldic device is shown upon its hull.

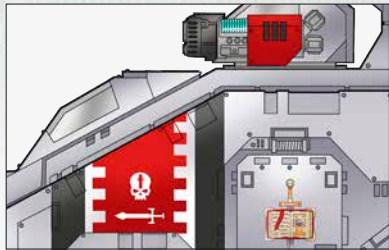

This pilot's personal heraldry is set over the squadron's black markings.

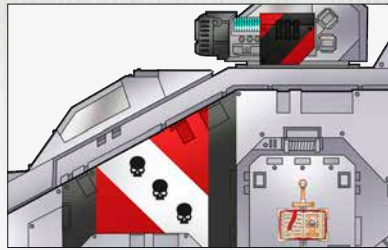

Here, the black squadron leader markings are on the weapon cowling.



Examples of Grey Knights honour heraldry upon ritual shields.

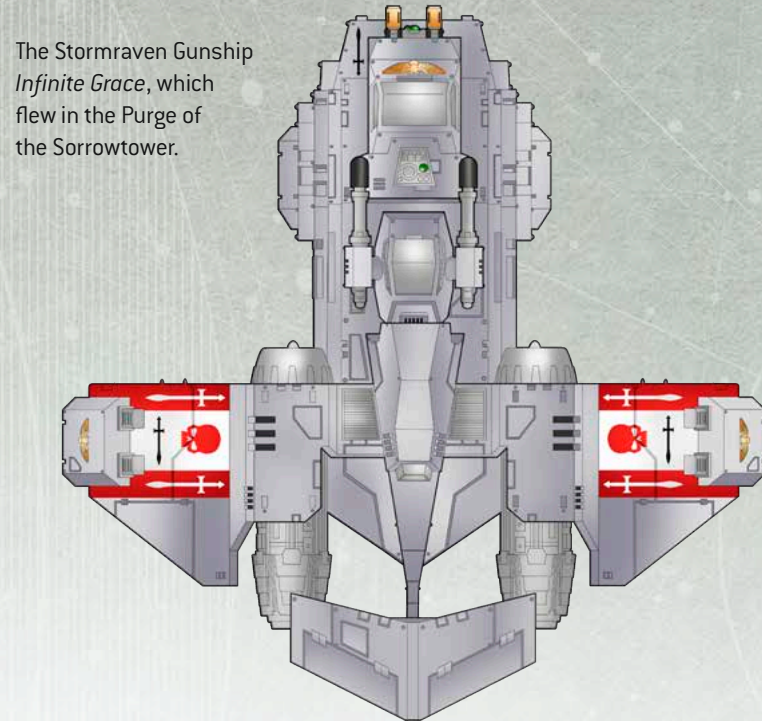

The Stormraven Gunship *Infinite Grace*, which flew in the Purge of the Sorrowtower.

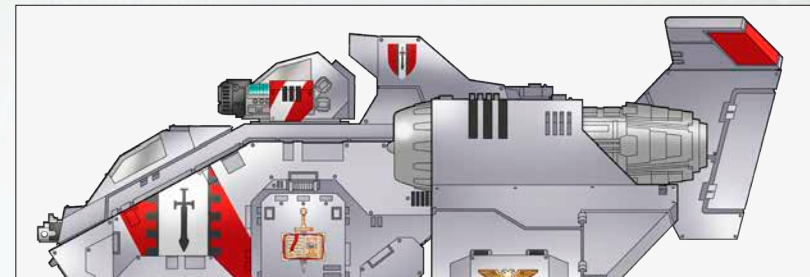

The Stormraven Gunship *Saintly Abjuration* flew during the Perfidian Breach. Note the white squadron leader markings on its turret's weapon cowlings.

DARK ANGELS

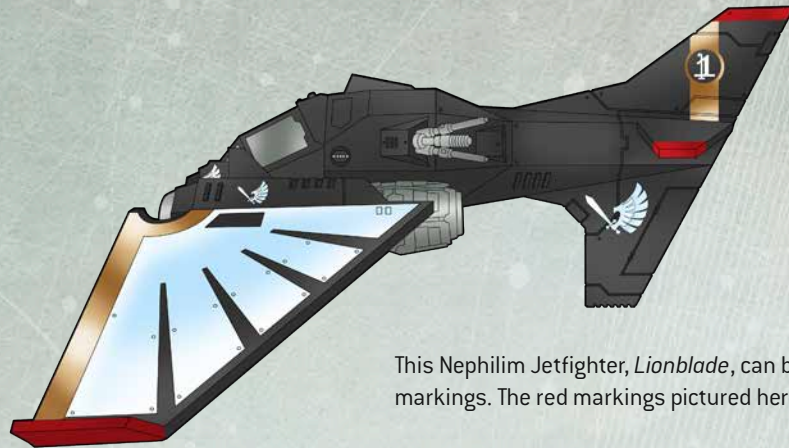

This Nephilim Jetfighter, *Lionblade*, can be distinguished as that of a sergeant by its golden markings. The red markings pictured here denote 'Merciless' Squadron.



Ravenwing Marines bear honour markings such as the one shown here, which can be applied to the hulls of their craft.

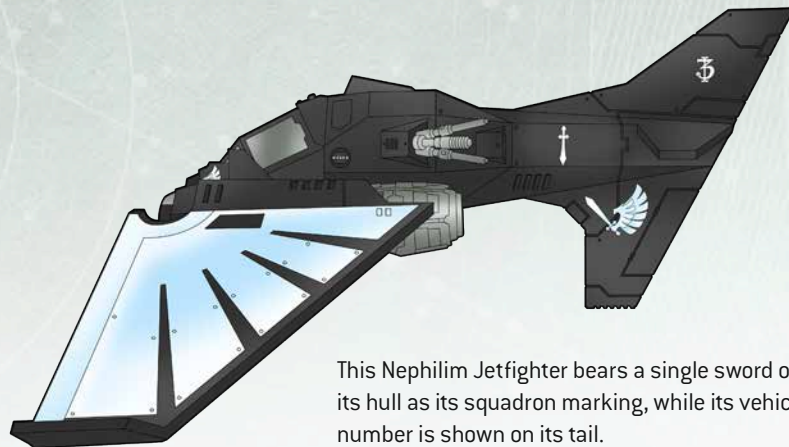

This Nephilim Jetfighter bears a single sword on its hull as its squadron marking, while its vehicle number is shown on its tail.



Conversely, as depicted here, a white band marks the squadron while the vehicle number is indicated using a sword design.



The above are examples of Ravenwing insignia used as either vehicle numbers or squadron markings, as required.



This Nephilim Jetfighter, the *Deathshadow*, shows its squadron with a red band – this is echoed on the shoulder of the squadron leader, Sergeant Zadkiel.

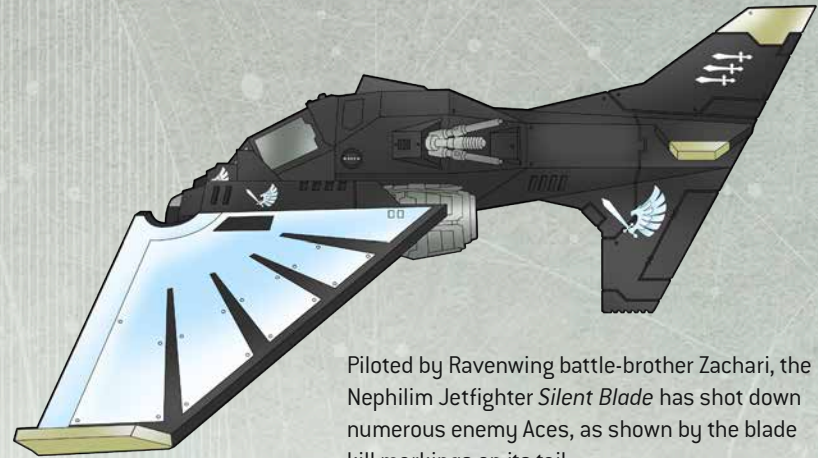

Piloted by Ravenwing battle-brother Zachari, the Nephilim Jetfighter *Silent Blade* has shot down numerous enemy Aces, as shown by the blade kill markings on its tail.

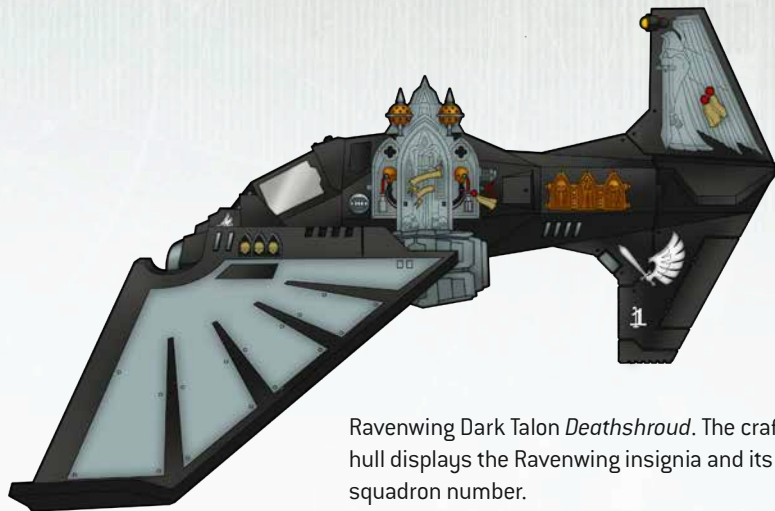

Ravenwing Dark Talon *Deathshroud*. The craft's hull displays the Ravenwing insignia and its squadron number.

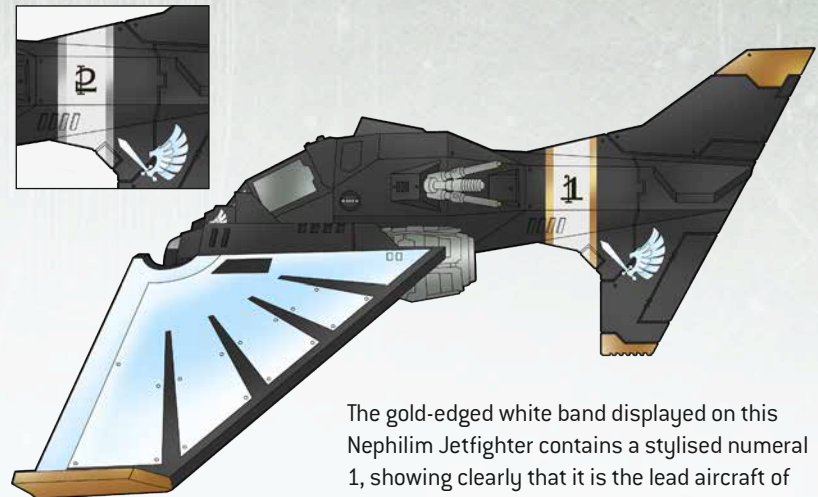

The gold-edged white band displayed on this Nephilim Jetfighter contains a stylised numeral 1, showing clearly that it is the lead aircraft of its squadron.

CHAOS SPACE MARINES



The Black Legion Heldrake *Infernal Harbinger* slew many Imperial pilots over the night world of Stargrave.



A Heldrake of the Black Legion, within which is caged the essence of the Khornate Daemon Khra'drax



Black Legion Helscourage *Malificum*, slayer of honoured Techmarine Orpharian

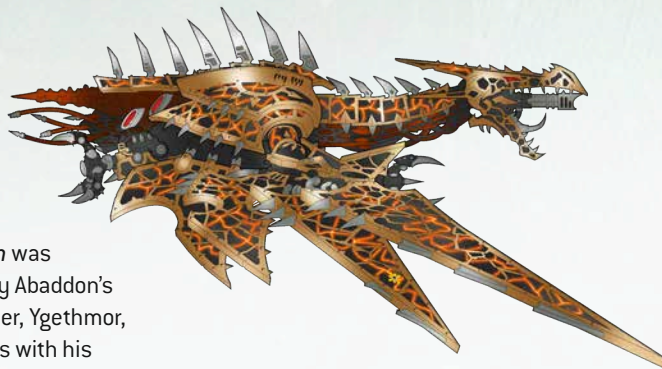

Daemonium was mastered by Abaddon's chief sorcerer, Ygethmor, and crackles with his sorcerous lightnings.

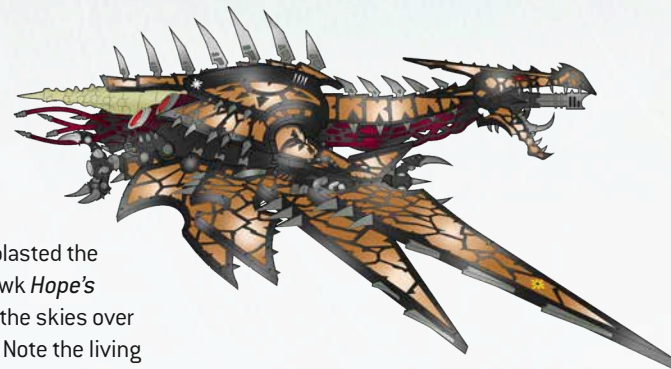

Firewurm blasted the Thunderhawk *Hope's Light* from the skies over Arcturos II. Note the living tissue under the plating.



The hate of the Daemon caged in the Heldrake *Devourer* causes its hull to glow white-hot.



Abomination slew hundreds during the notorious Dorask Genocides.



The ancient Helscourge known as *Eye of the Warp* is said to be thousands of years old.

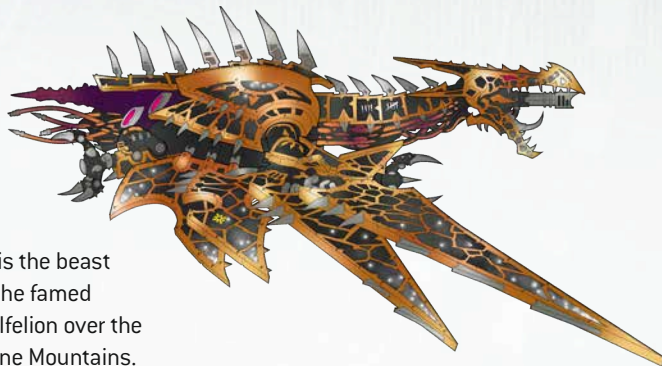

Voidheart is the beast that slew the famed Exarch Malfelion over the Shatterspine Mountains.



This Helscourge is named *Monstrosity* and has lived up to its threatening name in many war zones.

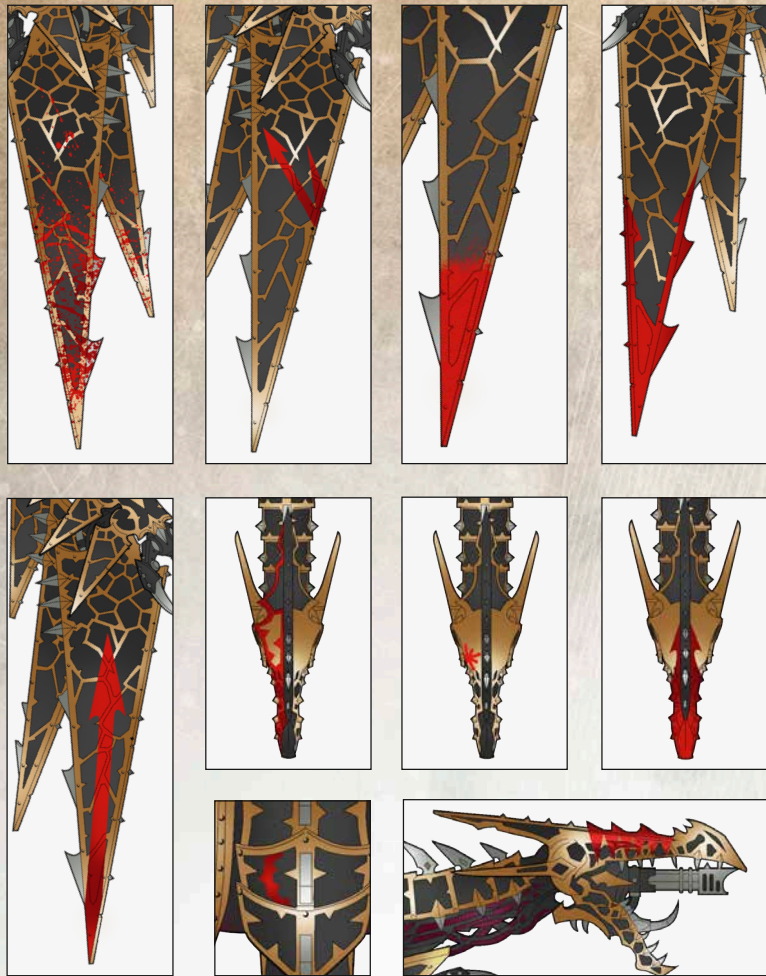

The leaders of the Heldrake packs are known as Anointed, and they are usually distinguished by the application of differently coloured patterns and panels upon their heads, hulls and wings. Such designs are applied by the heretical Warpsmiths, frequently in the tainted blood of sacrificial victims.



Cruelty Incarnate is an Anointed Heldrake that is easily distinguished by the blood-coloured markings on its head and body.

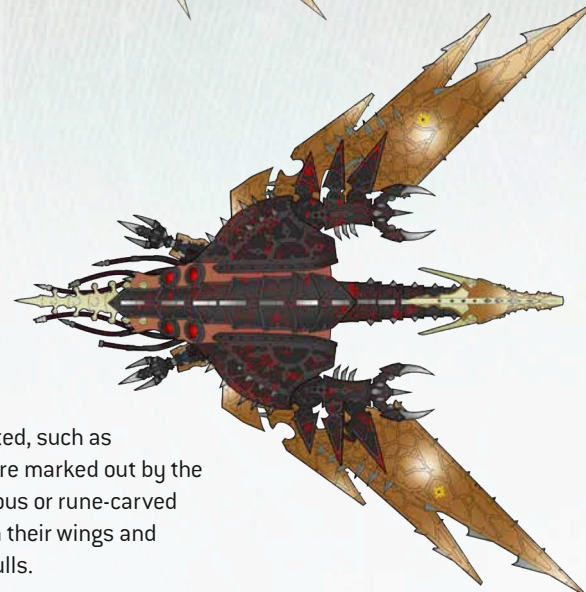
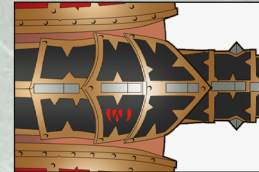

Some Anointed, such as *Baneclaw*, are marked out by the use of precious or rune-carved metals upon their wings and draconic skulls.



The Anointed named *Savagery Incarnate* has marked itself out by dipping its wing tips and muzzle in fresh gore.

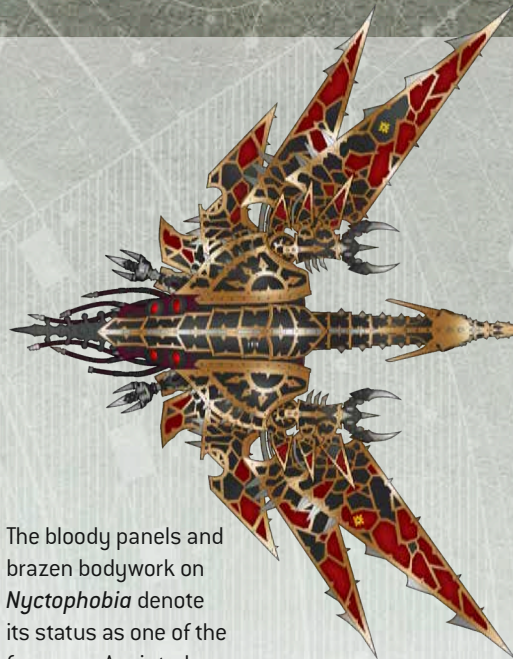

The bloody panels and brazen bodywork on *Nyctophobia* denote its status as one of the fearsome Anointed.



The crimson panelling boasted by *Purgatorax* show that this Daemon Engine slew its previous Anointed.



The most accomplished Warpsmiths are given to marking out their Anointed creations with all manner of spectacular and menacing skull patterning. In other cases, Anointed develop such markings spontaneously – a reward from the Dark Gods for the slaughter they wreak.

ተላህዘብ ሩካዕ ገቆ ተላህዘብ ይህብ

'Blood for the Blood God!'

ዓለረረ ሰብ

'slaane-sh'

ተካዕቦ

'kh-orn'

ሰሀዕይ

'nur-gu-l'

ገቦ ገሩ

'tz-n-t-ch'

Many Helderakes bear markings in the Dark Tongue, be they testament to foul devotion or sorcerous curse upon the foe.

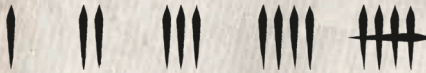
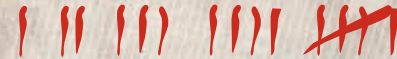
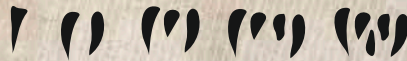

Warpsmiths inscribe their favoured Helderakes with kill markings to display the Daemon Engines' savagery and prowess.



The Chaos star is a design frequently seen upon Helderakes, both as heraldry and a binding.

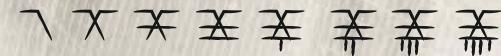

Some Khorne Daemonkin warbands use a crude system of numbering to mark their Helderakes.



This Helderake, *Unrelenting Slaughterer*, belongs to the terrifying Khorne Daemonkin warband known as the Wrath.



The infamous Red Corsairs make great use of Helderakes such as *Monstrum Diabolus* in their sudden terror-raids upon the Imperium.



This Helderake of the Khorne Daemonkin warband known as the Harvest flew during the horrific bloodslaughter raids on Taeven's Reach.



Proclamation of Flames, a Heldrake Anointed of the Word Bearers



This Heldrake, *Wraithserpent*, belongs to the traitorous Alpha Legion and flew on Grimtide.



Primordial Horror is a Heldrake Helscourge of the terrifying Night Lords Traitor Legion.

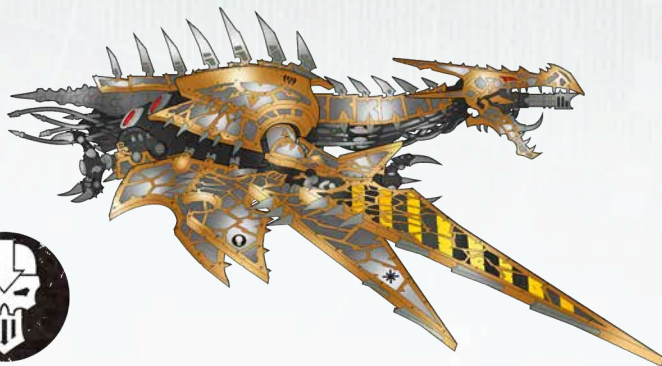

The brass hull and hazard stripes on this Heldrake mark it out as belonging to the Iron Warriors Traitor Legion.



This Heldrake, *Voice of Madness*, is a daemonic war engine of the renegade warband known as the Crimson Slaughter.



Flying in support of a psychotic band of World Eaters, *Bloodmaw* is greatly feared.



The Daemons caged within the World Eaters' Heldrakes are the most bloodthirsty of their savage kind.



A Heldrake of the degenerate Slaanesh-worshipping warband, the Hedonistarii



This Heldrake, known as *Unspeakable Horror*, is one of many such Daemon Engines that fly for the Brazen Beasts.

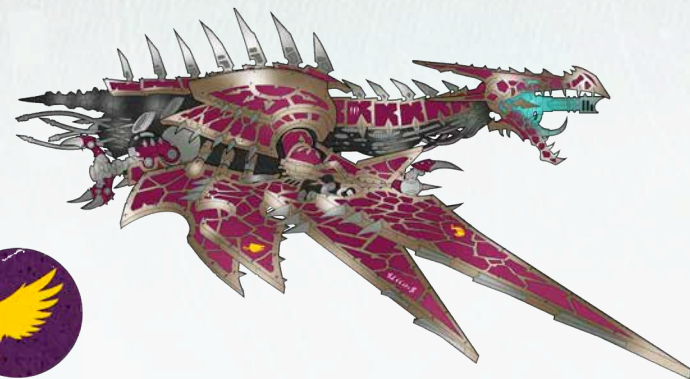

The Heldrake *Paroxysm of Madness*, of the Emperor's Children, derived great pleasure from the slaughter that took place during the scouring of Longhollow.

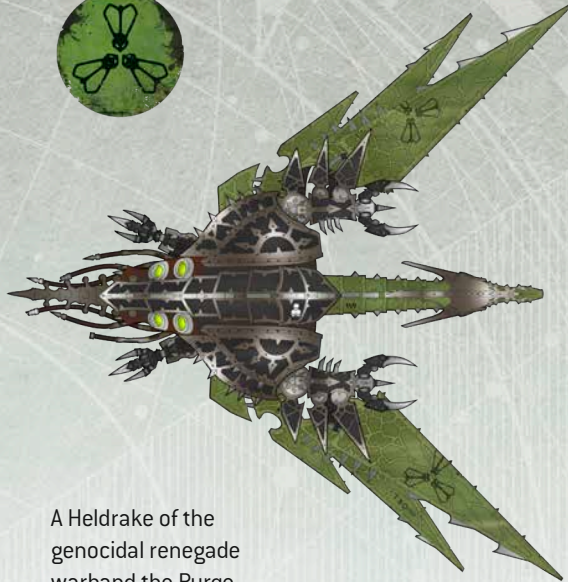

A Helderake of the genocidal renegade warband the Purge, known as *Eater of Souls*



This Black Legion Helderake barely contains the bloated and enraged essence of a powerful daemon of Nurgle.



Many babbling Tzeentchian daemons are bound within the Warp-steel hull of the Helderake *Cacophonous*.

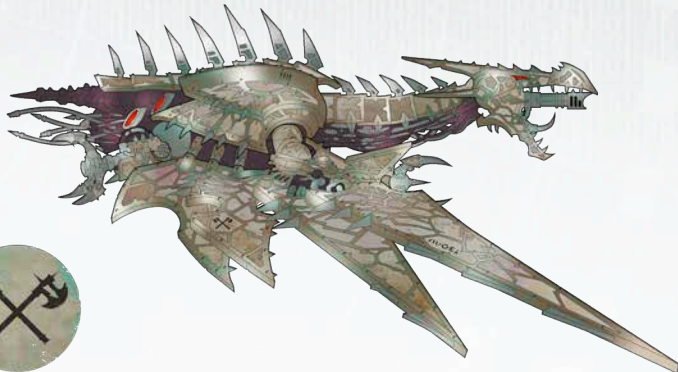

The Helderake *Dilheart* belongs to the Cleaved, a particularly hideous traitor warband that worships Nurgle.



Belonging to the Tzeentch-worshipping warriors of the Thousand Sons, the Helderake known as *Malice Draconius* devours the souls of the faithful with delight.

NECRONS

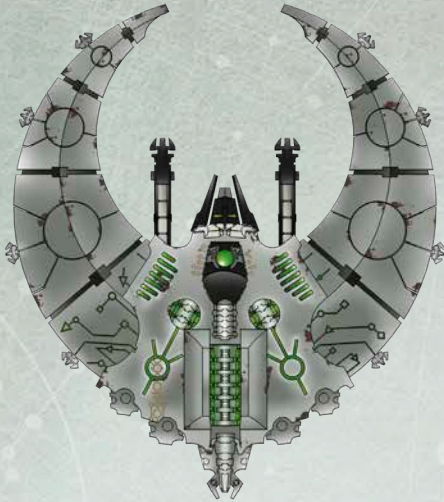

The Lordsblood *Ancient Majesty* dominated the skies during the invasion of Thesakopia and was elevated by its Overlord as a result.



Marked out by the ancient glyphic inscriptions that crawl across its hull, this Night Scythe is greatly prized by its Overlord.

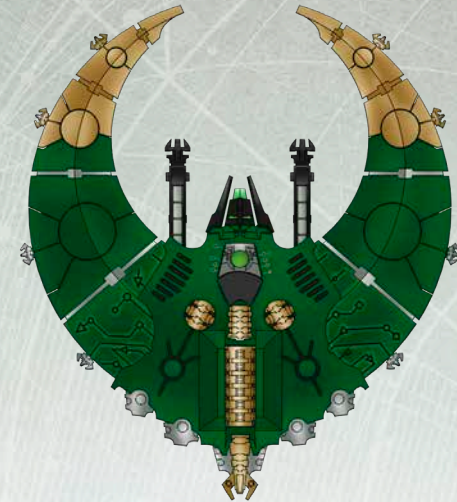

This Lordsblood Doom Scythe, which bears the name *Entropy's Demise*, is distinguished as a great weapon through its gold plating.

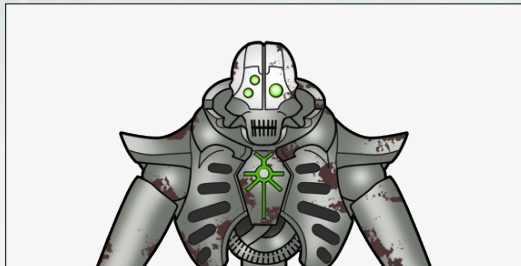

The pilot of *Ancient Majesty* has flown amongst the Skylegions of the Sautekh Dynasty for millennia, and bears the scars of incredible longevity.



Clad in a layer of dragonjade mined from the Retican Star Ocean, the pilot of *Majestic Void* has been marked as a favoured tool of war by its liege.

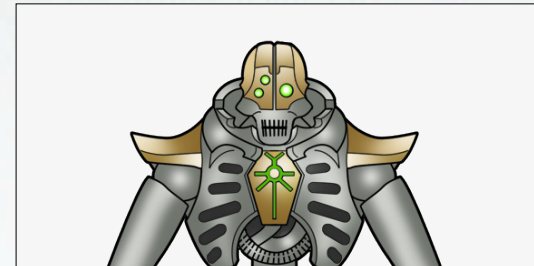

The pilot of *Entropy's Demise* displays the gold of the Overlord upon its helm and pauldrons, in honour of many impressive dogfight kills.



The Night Scythe *Aeon* glows with the eldritch power that surges through its augmented systems.



This Night Scythe is many millennia old, its hull bearing the patina of the passing years.



Hand of Haptrotek is finely decorated to honour its victories during the defence of Phaktrovokh.



Sandwraith was the terror of Imperial pilots during the attempted purge of Tomb World Molonekh.

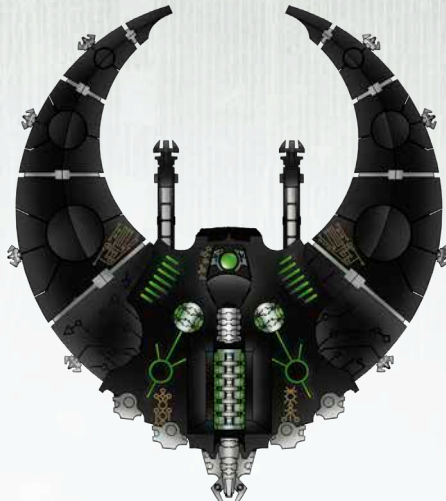

During the invasion of Caliope, this Lordsblade plied the dark skies, assassinating enemy pilots.



Recently awoken from a flooded tomb on Balaenum, this Night Scythe is still a lethal weapon of war.

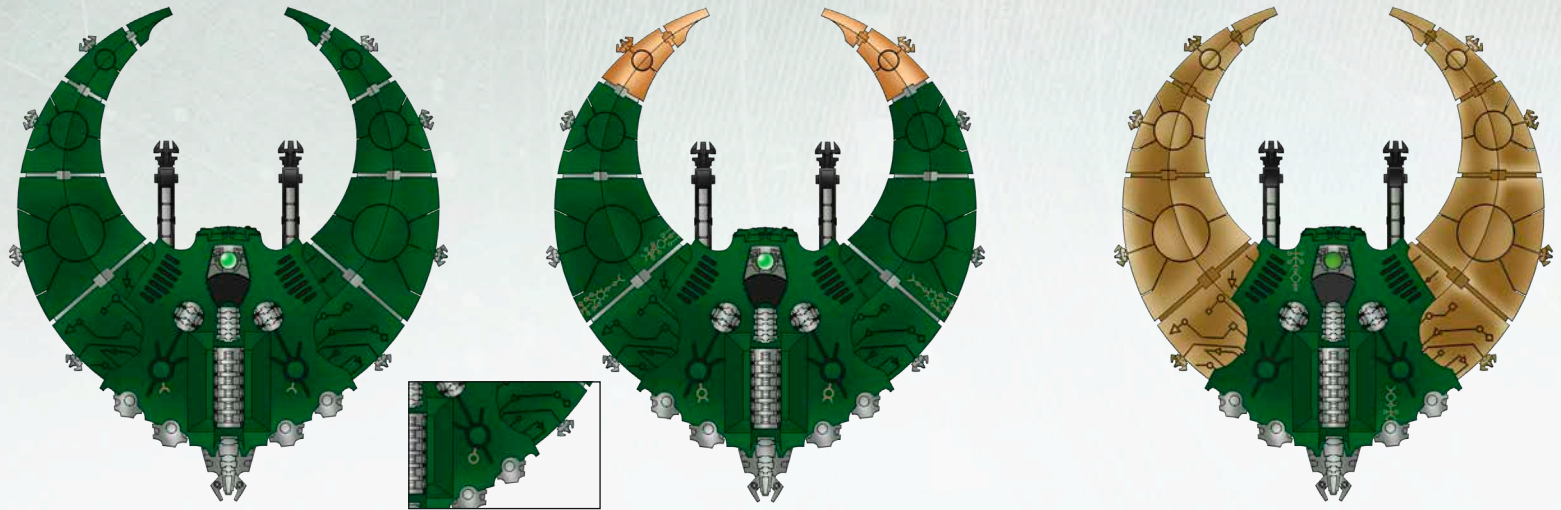
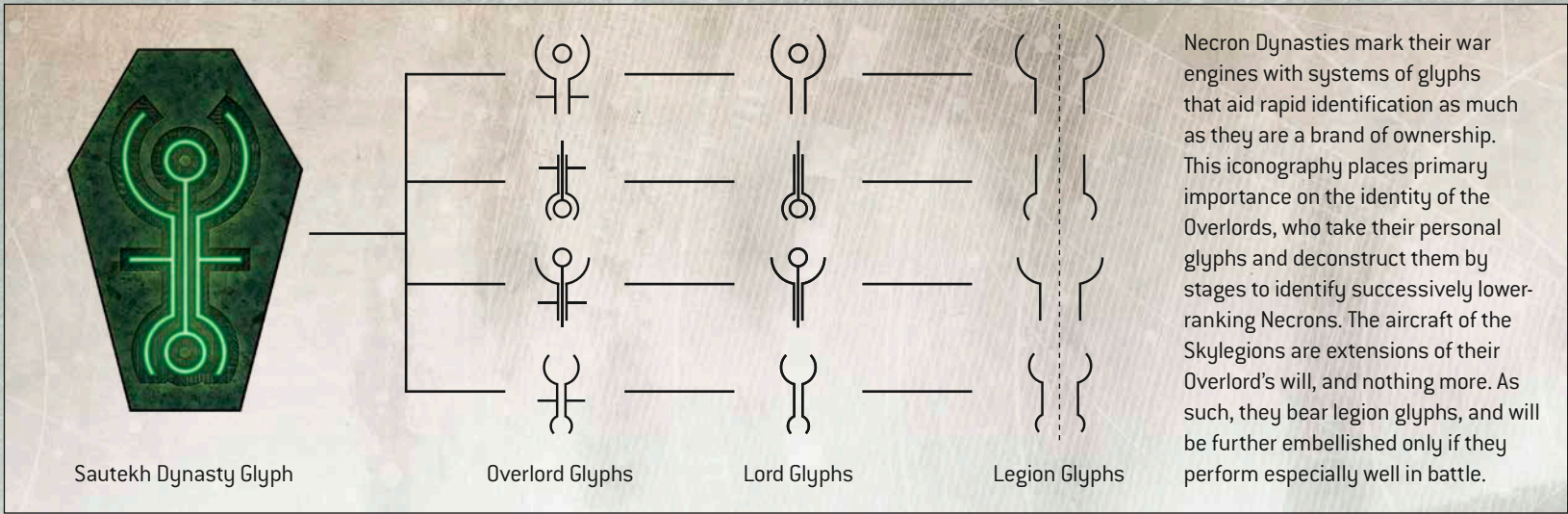

Two Night Scythes of a Sautekh Dynasty flight. The flight leader earned the gold wing tips that mark its status by bringing down a full mob of Ork Blitzza-bombers during the Vorgendask Incursion.

Another Sautekh flight leader, whose wings were dipped in molten gold to boast of its many kills

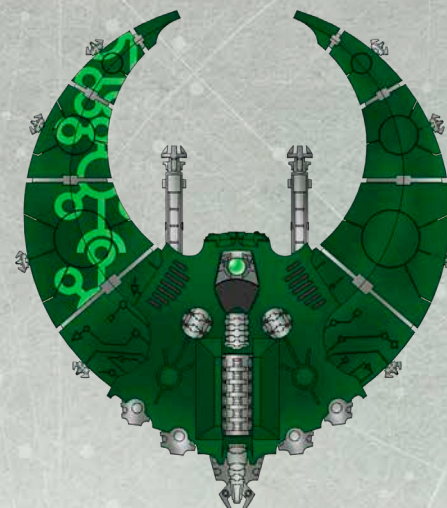

Above are pictured two Doom Scythes of a Sautekh Dynasty flight. Note that the flight leader bears a more elaborate glyph above its engine cowlings, and a more complex pattern upon its wings.

The magnified hieroglyph wing marking shows this craft belongs to the cohort's Cryptek guard.

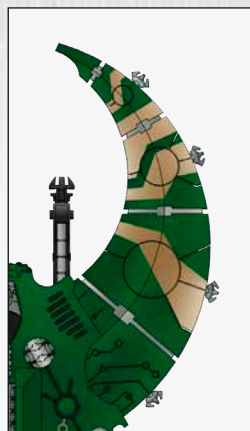
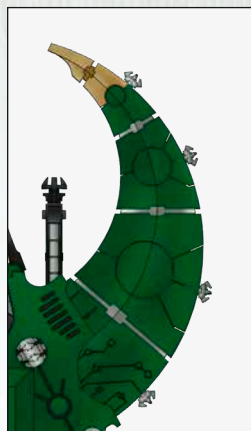
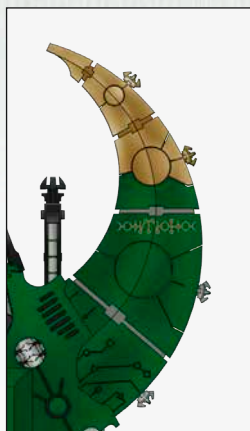
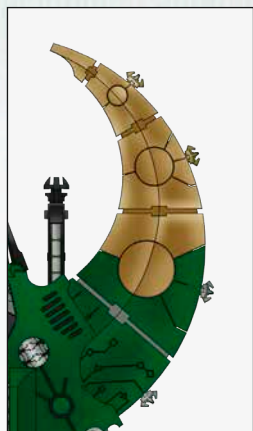

Here can be seen examples of the ways in which Skylegion flight leaders are picked out, from different-coloured wing tips to elaborate overlaid patterns. These markings are often made with precious metals as a display of the Overlord's wealth and power.



Above are a number of kill marking glyphs, which are etched around the cockpits of particularly deadly Necron aircraft.

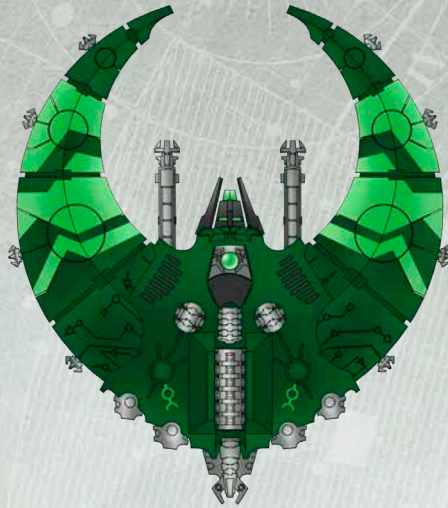
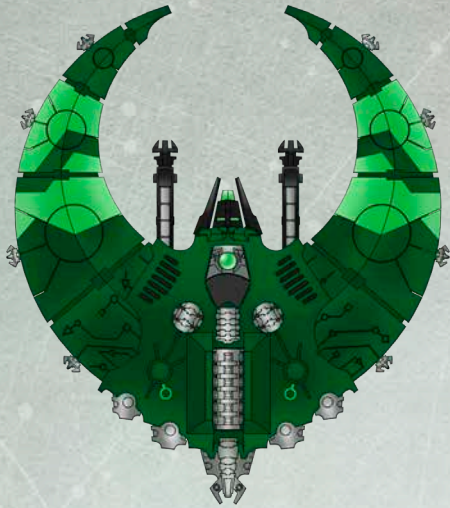

These Doom Scythes, two of a flight that fought during the Valhalax Schism, show wing markings that echo the deadly green energies of their Overlord's staff of light.

Examples of legion glyphs used as flight markings. Each becomes more elaborate as the sequence ascends.

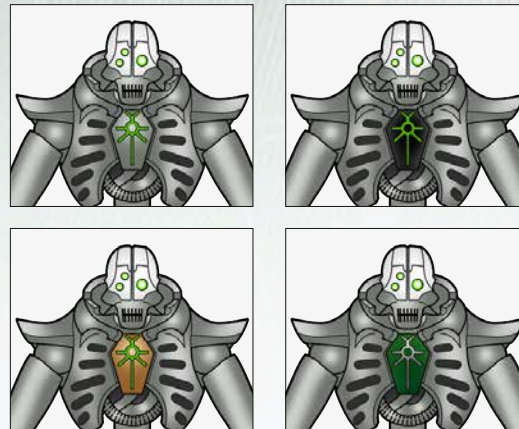
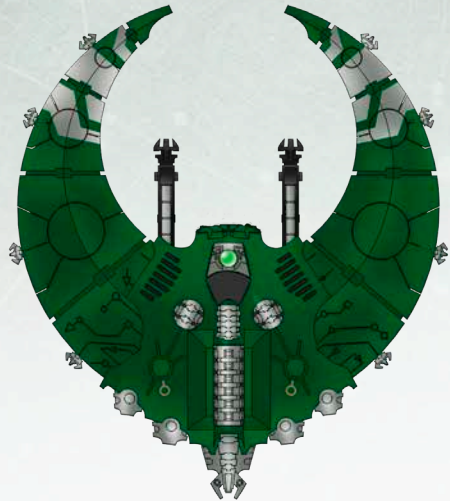

This Night Scythe ruled the skies over the tomb world of Meikhos during its troubled awakening.

As with Necron infantry, the colour of the chest cartouche over which a pilot's dynastic ankh is displayed denotes the Lord to whom they owe fealty.

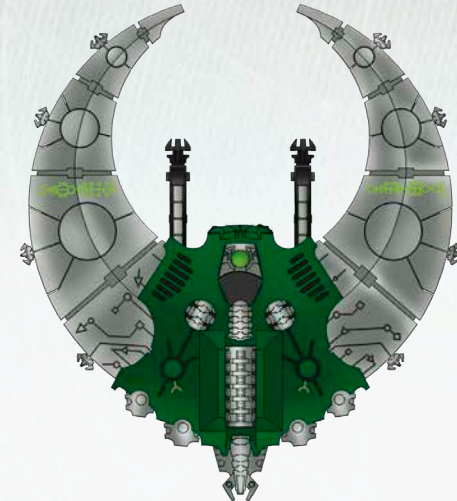

The silver of this Night Scythe's wings matches the pilot's chest cartouche, the living metal never at rest.

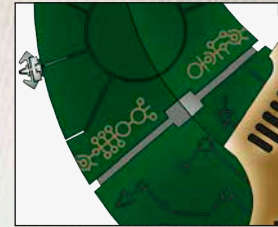
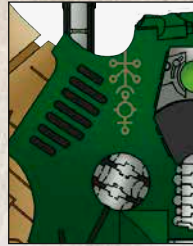
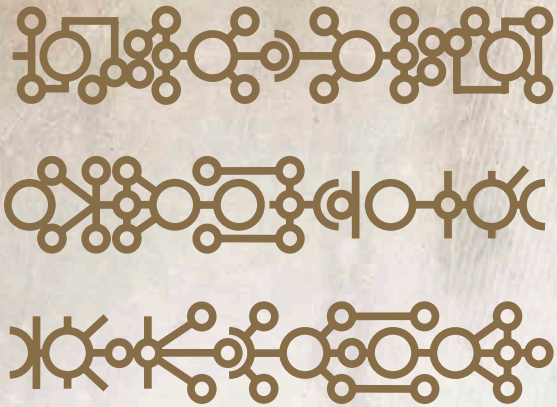

The hieroglyphic strings of text that decorate Necron combat aircraft were archaic when the first Terran life forms dragged themselves from the primordial ooze. They are incredibly complex and nuanced, combining numerical sequences with pictographic representations, cosmological references and electrosequential coding. They convey messages of doom upon the younger races, of Necron supremacy over the galaxy, and of the might and wealth of the ruling Overlord.



Witnessed in the skies over Dekundra during a Tyranid invasion, this Night Scythe flight bears the ankh of the Triarch instead of that of an Overlord. The meaning of this unusual iconography remains a mystery.



This Doom Scythe flight leader has been greatly honoured with gold plating over its hull's midsection.

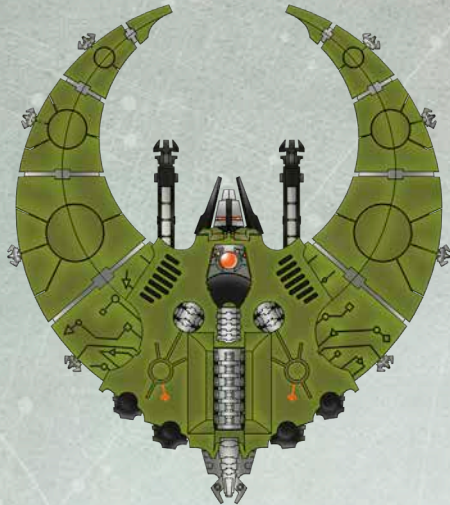

Immeasurable Supremacy, a Doom Scythe of the Mephrit Dynasty's 3rd Cohort

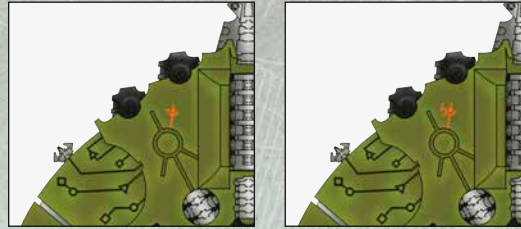

Here can be seen squad member and flight leader glyphs of the Mephrit Skylegions.

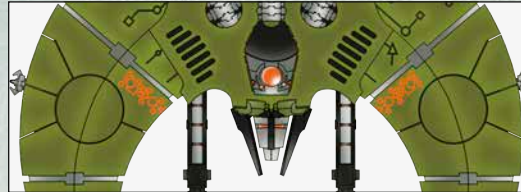

The Mephrit Dynasty often uses hieroglyphs to denote its most deadly and accomplished aircraft.



This Night Scythe is marked as a flight leader by its golden glyphs and black wing patterning.

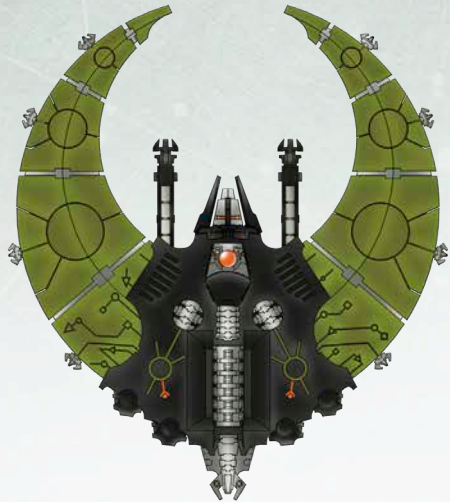

This black hull variant is borne by the infamous Doom Scythes of the 12th 'Obsidian Scarabs' Flight.

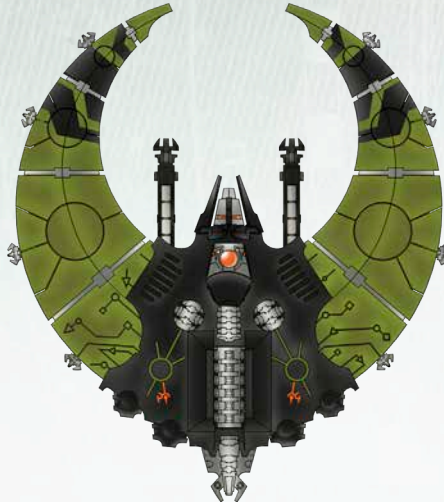

The flight leader of the 'Obsidian Scarabs', complete with black wing markings

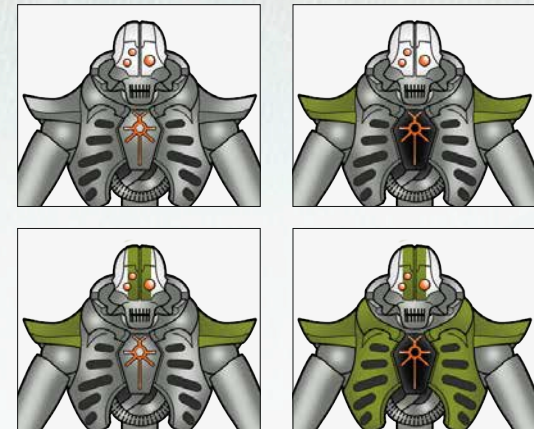

Mephrit pilots typically have white helm markings, with the more accomplished amongst them displaying further embellishments.

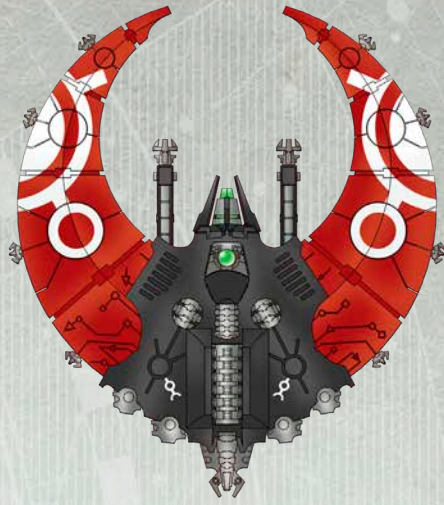
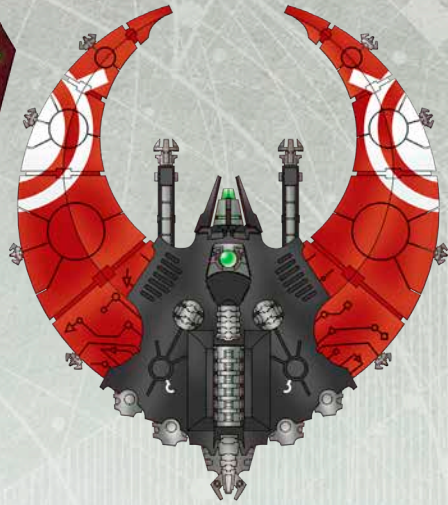

These two Doom Scythes, *Voidborne* and *Killing Star*, are part of the 5th Flight of the Novokh Dynasty's 2nd Cohort. They were at the head of the aerial ambush on Tagaren's Landing.



Novokh Overlords mark their pilots' helms with white to signify a noble death in their service, and gold to reflect a millennium of worthy serfhood.

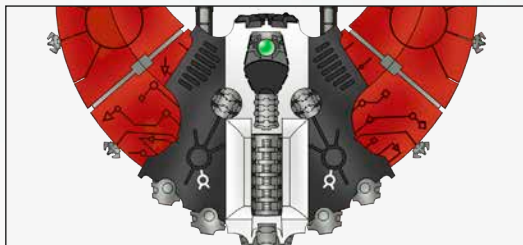
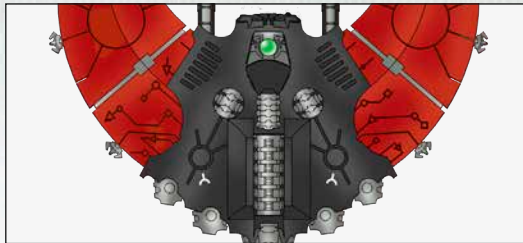

The flight leader shown here bears additional decoration: a white band matching that on his helm.

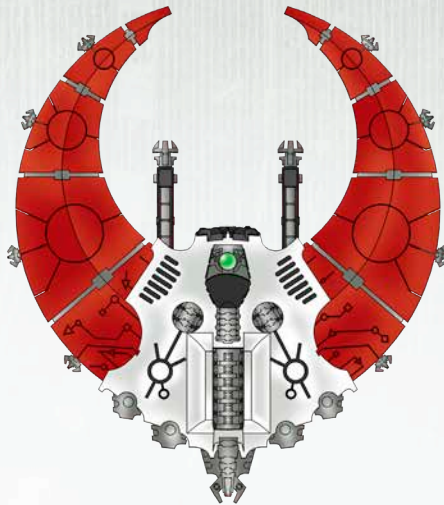

A Night Scythe of the Novokh Dynasty, this craft bears a variation marking in the form of its white hull.

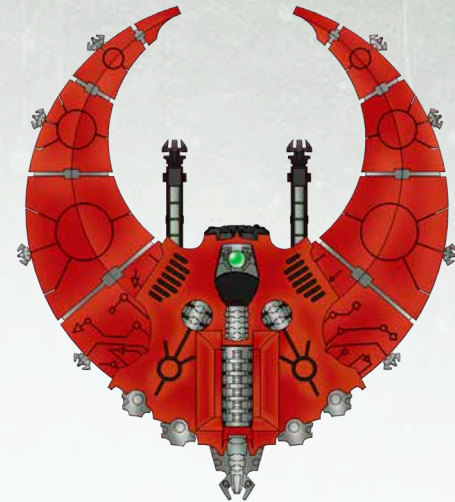

The Night Scythe *Solar Bane* is entirely red to symbolise the cursed blood moon of Tothos.



The proud Charnovokh Dynasty displays the ankh on the wings of even their lowliest Night Scythes.

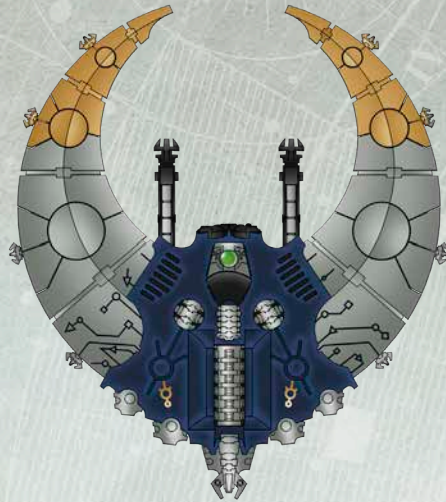

This Charnovokh flight leader can be identified by his silver and gold wing patterning.



Ruler's Might, a decorated Night Scythe in Overlord Hamnokeph's all-blue Cohort

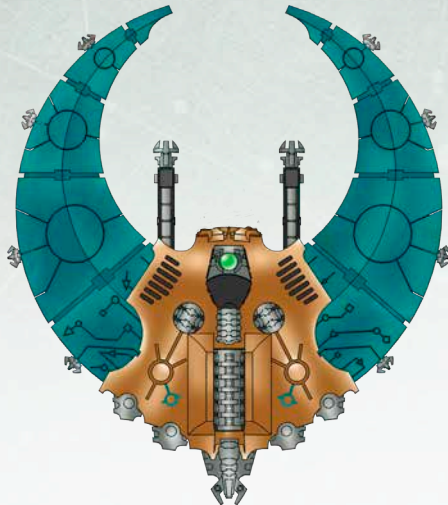

This Night Scythe displays the standard colouration and glyphs of the Nihilakh Sky Legions.

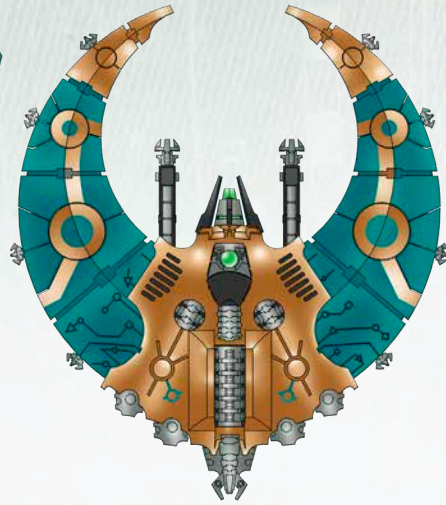

Destined for Supremacy, a flight leader of the feared Nihilakh 17th 'Ancients' Flight who fought over Thot'n

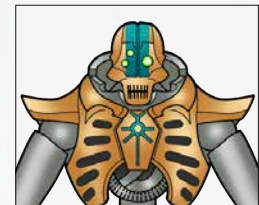

Above are several Nihilakh colour variants, the bottom two of which are an 'Ancients' pilot and a flight leader, the so-called Reaper of Thot'n.



Blade of Dust, a Night Scythe showing a variation on the basic Thokt Skylegion colouration

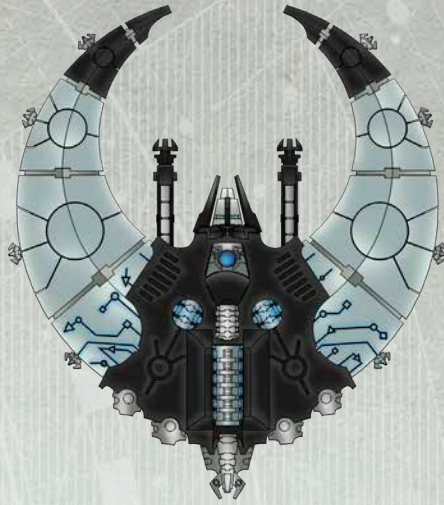

This Thokt flight leader's craft glows with power beneath its distinctive moonsilver wing patterning.



This craft bears the heraldry and colours of the Thokt Dynasty. Note glowing hieroglyphic circuitry.

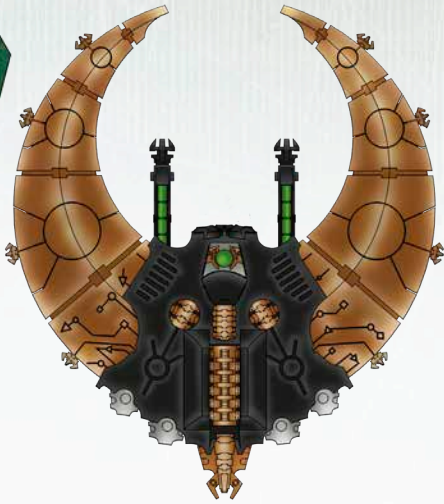

Cosmos Afire, a Night Scythe of the 6th 'Sandstorms' Flight of the Nephrekh 10th Cohort

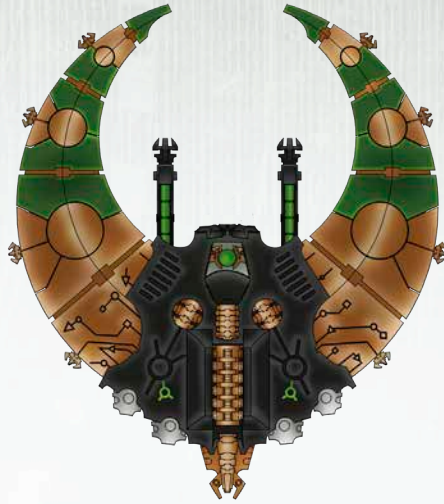

This Night Scythe flight leader slew the Ork Flyboss Dakbad Wingsnapper during aerial combat on Dost.



Some Nephrekh aircraft are so ancient that they flew during the early days of the War in Heaven.

TAU EMPIRE

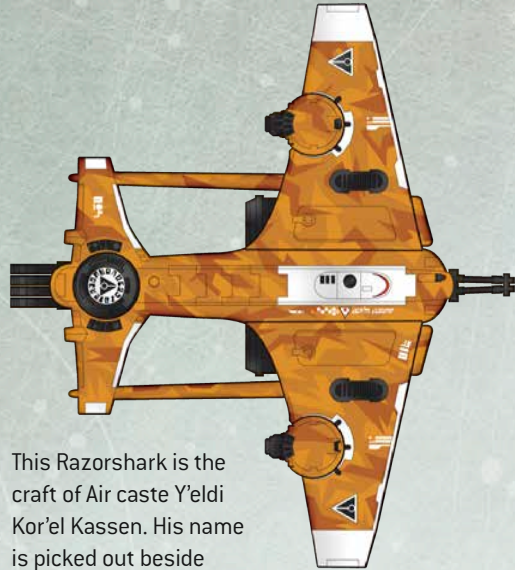

This Razorshark is the craft of Air caste Y'eldi Kor'el Kassen. His name is picked out beside his cockpit.

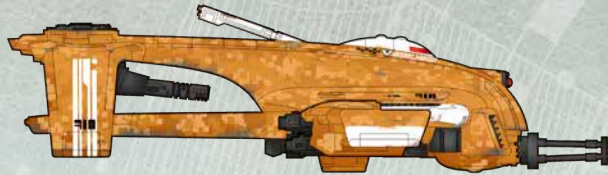

The AX3 Razorshark Strike Fighter *Enlightenment*, piloted by the famous Kor'vre Laun'tal, hero of Raska

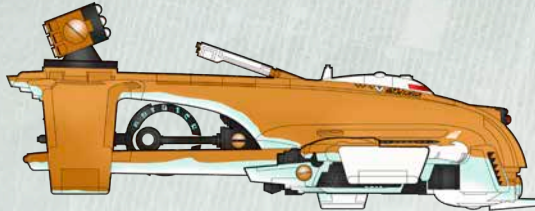

Kor'la Tan'kal is a well known y'eldi of the T'au Sept, and pilots *Clouded Blade*.



The Sun Shark Bomber of Kor'ui Shol'vos bears many kill markings in the white of its sept.

The y'eldi ('winged') of the Tau Air caste are their greatest combat pilots, and their skill and accomplishments are marked out using a precise system of iconography.

Only y'eldi are permitted to display the triangular markings beside their cockpit that denote their status, each one a personalised design. Their names are proclaimed in Tau script next to this, so that all might know who it is that so bravely upholds the Tau'va.

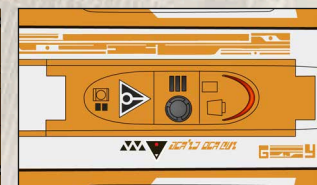
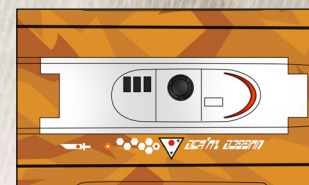
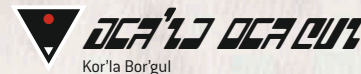

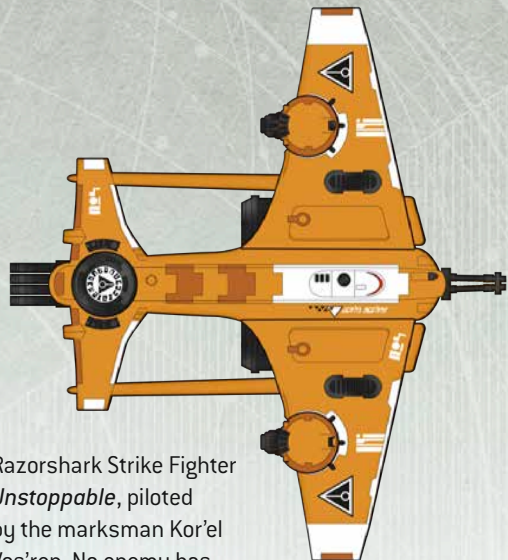

Razorshark Strike Fighter *Unstoppable*, piloted by the marksman Kor'el Vos'ren. No enemy has escaped its sights alive.

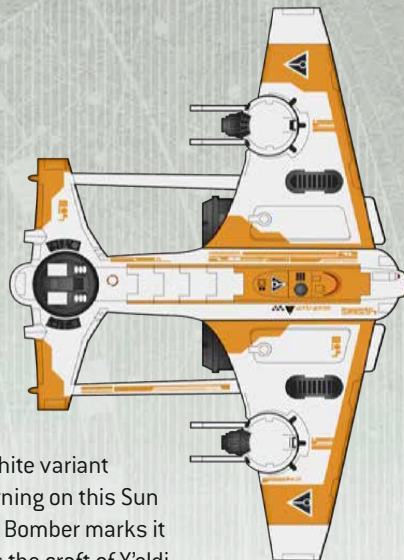

The white variant patterning on this Sun Shark Bomber marks it out as the craft of Y'eldi Kor'la Bor'gul.



Kor've Au'vas and his Razorshark *Conqueror* slew several Space Marine Aces during the night war on Bastrol.

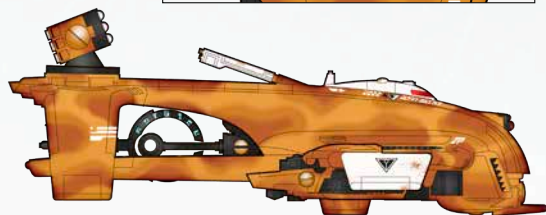
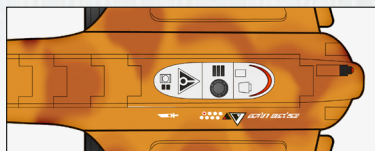

Kor'ui Sal'serra pilots the infamously lucky AX39 Sun Shark Bomber *Against All Odds*.



The symbol of the Air caste is borne proudly upon every single Tau aircraft. The Air caste are the division of Tau society that serve as pilots and spacefarers, their hollow bones and willowy frames making them ideally suited to aerial combat roles.

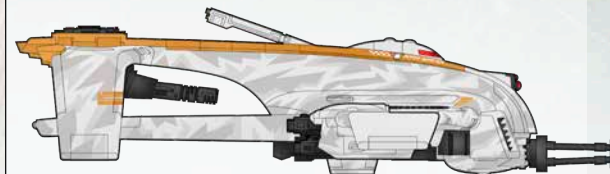
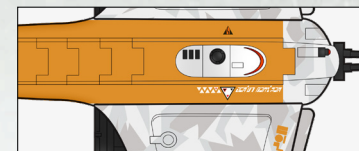

Kor'ui Mael'dar and his winter camouflaged Razorshark *Ghost of the Dawning*



This Razorshark Strike Fighter belongs to the Air caste of the T'au Sept. It shows the Air caste sept icon on its wings.

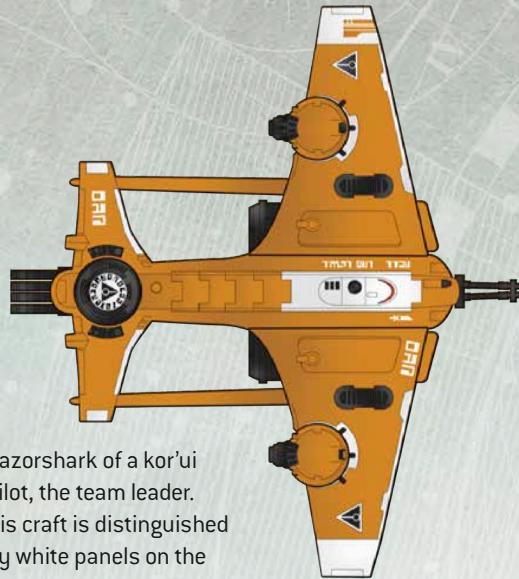

Razorshark of a kor'ui pilot, the team leader. His craft is distinguished by white panels on the cockpit and wing-tips.

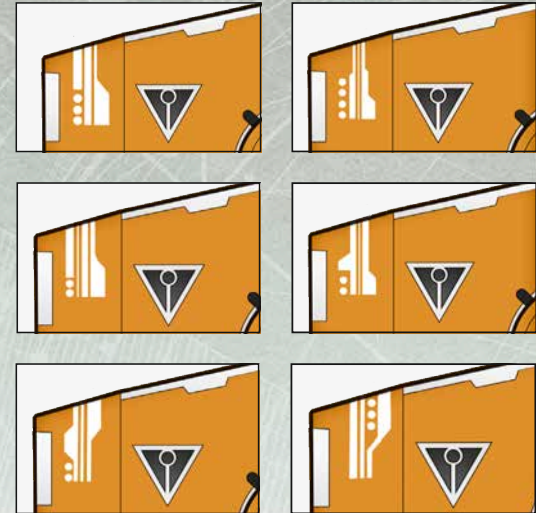

The white markings on the wings denote which cadre and team each aircraft belongs to.

1	2	3	4
5	6	7	0

The Tau numerical system is rendered as above, and is used to identify their fighting vehicles. Characters from zero to seven are used in varying combinations, marking out cadres and applying ascending identifier numbers within them.

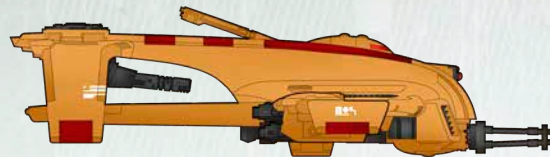

This team uses additional red panels to mark out its aircraft. These are signs of battle honour.

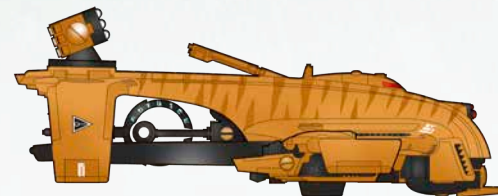

The Tau alter their colour schemes to suit prevailing local conditions. This craft has desert camouflage.

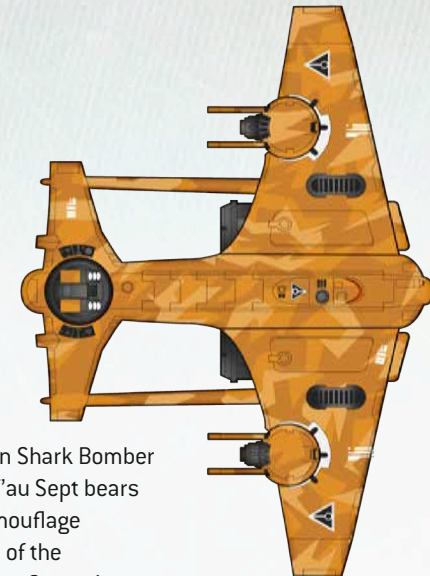

This Sun Shark Bomber of the T'au Sept bears the camouflage pattern of the Des'treya Campaign.

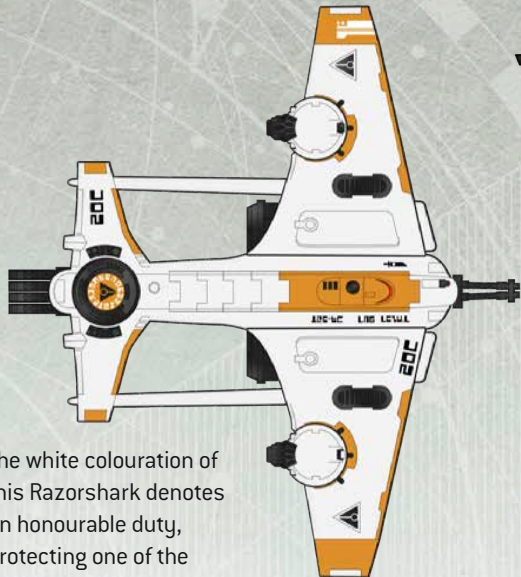

The white colouration of this Razorshark denotes an honourable duty, protecting one of the precious Ethereal caste.



This AX3 Razorshark Strike Fighter, *Torchbearer*, is clad in night world camouflage. The lack of sept markings indicates a pilot seeking to redeem himself.

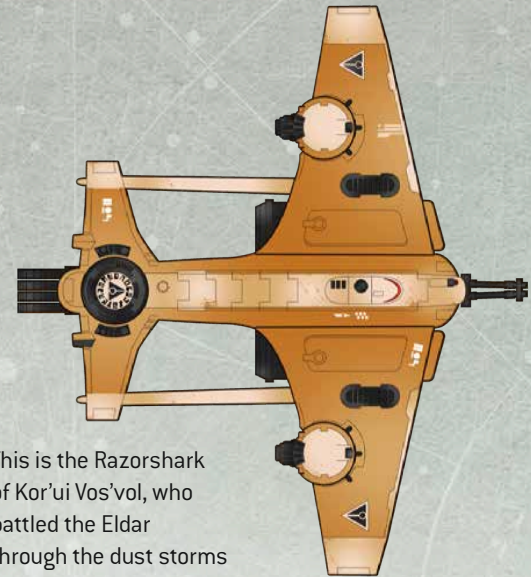

This is the Razorshark of Kor'ui Vos'vol, who battled the Eldar through the dust storms of Gholvara.

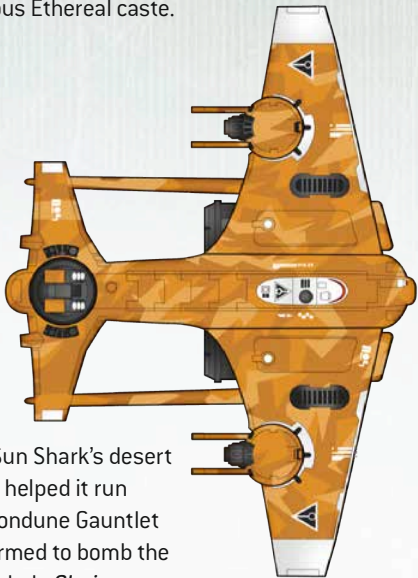

This Sun Shark's desert camo helped it run the Irondune Gauntlet unharmed to bomb the Baneblade *Glorious*.

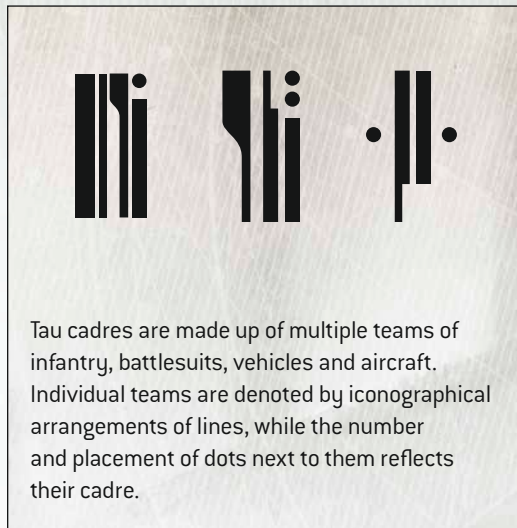

Tau cadres are made up of multiple teams of infantry, battlesuits, vehicles and aircraft. Individual teams are denoted by iconographical arrangements of lines, while the number and placement of dots next to them reflects their cadre.

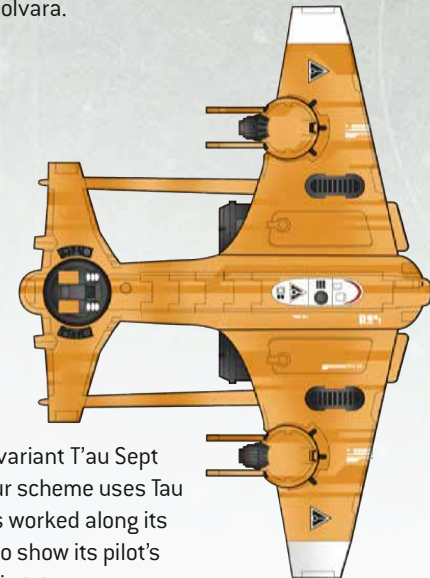

This variant T'au Sept colour scheme uses Tau icons worked along its hull to show its pilot's kor'ui status.

The Air caste use numerical arrangements of dots, triangles, hexagons and the like to show noteworthy kill tallies. These are typically applied alongside the cockpit.

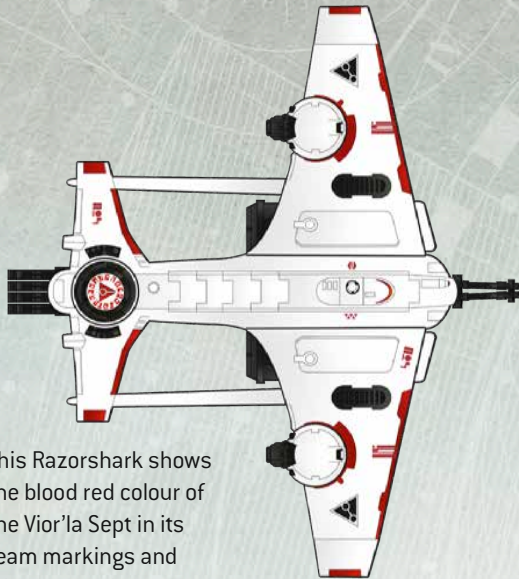

This Razorshark shows the blood red colour of the Vior'la Sept in its team markings and wing patterning.

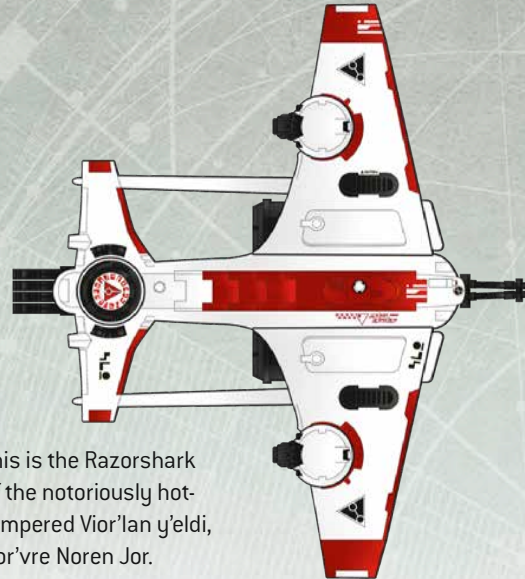

This is the Razorshark of the notoriously hot-tempered Vior'lan y'eldi, Kor'vere Noren Jor.

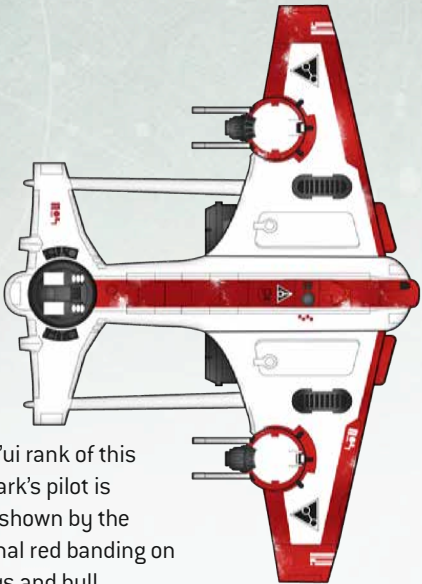

The kor'ui rank of this Sun Shark's pilot is clearly shown by the additional red banding on its wings and hull.

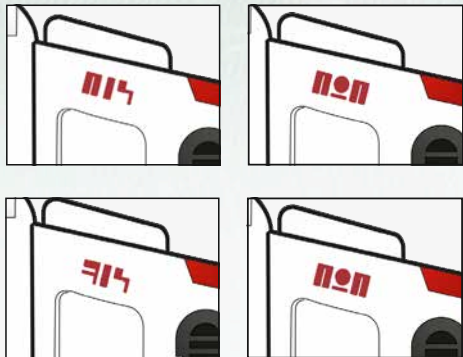

Many pilots of the Vior'la Air caste inscribe the tail-fins of their craft with slogans and inspirational extracts from the Tau'va.



The reversed colours of this Razorshark mark it out as the personal craft of Kor'ui Tan'des, a decorated y'eldi.



The umber sept colour on this Razorshark Strike Fighter marks it out as the craft of a kor'ui from Sa'cea Sept.



The camouflage pattern on this craft is from the war against the Imperium above storm-tossed Lam'braga.

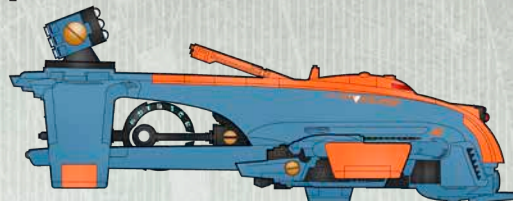

Kor'ui Vos Shassa pilots this AX39 Sun Shark Bomber. His masterful bombing runs are legendary.

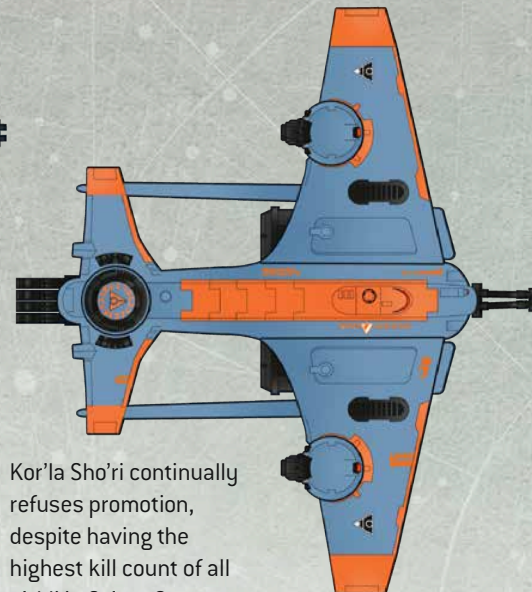

Kor'la Sho'ri continually refuses promotion, despite having the highest kill count of all y'eldi in Sa'cea Sept.



This Sun Shark is mostly blue, only showing the Sa'cea Sept colours in its cadre and team markings.

TAU ALPHABET

	A		B		C/K		D		E		F/V		G		
	H		I/Y		J		L		M		N		O		P
	R		S		T		U		W		X				

The Tau alphabet is wildly different from those of humanity. It is unified across the entire Tau Empire, though regional dialects do exist, and it is heavy with metaphor and complex meanings. The Tau use these letters to spell out pilot names and inspirational slogans upon their craft, drawing strength from them.

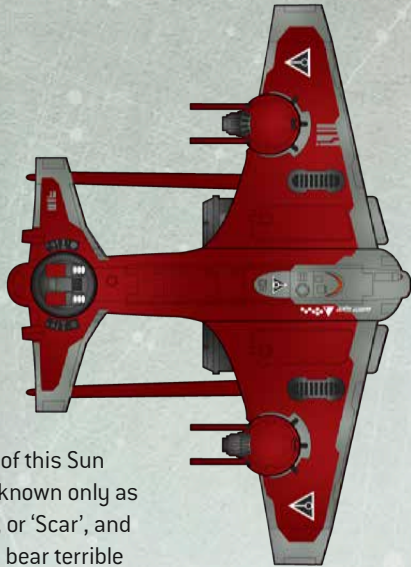

The pilot of this Sun Shark is known only as Ka'mesa, or 'Scar', and is said to bear terrible disfigurements.

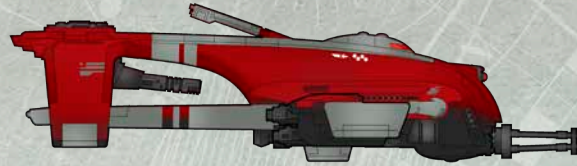

An AX3 Razorshark Strike Fighter, showing Farsight's distinctive red colouration and grey team markings



This Sun Shark has a black underbelly to obfuscate its presence during night time raids.

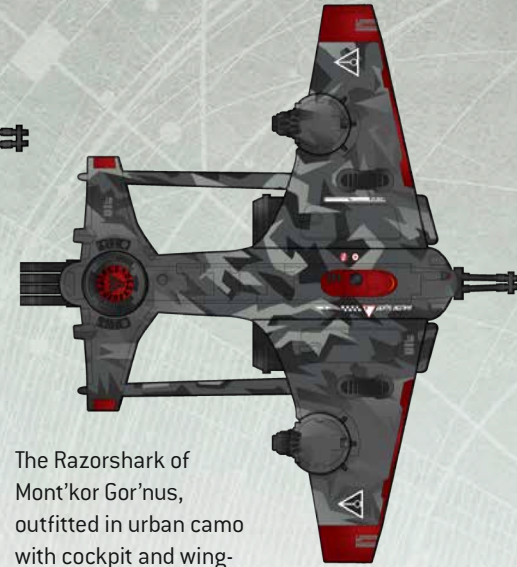

The Razorshark of Mont'kor Gor'nus, outfitted in urban camo with cockpit and wing-tips of Farsight's red

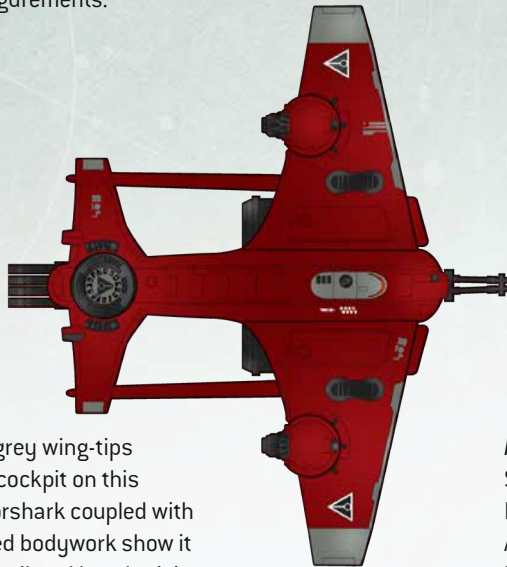

The grey wing-tips and cockpit on this Razorshark coupled with its red bodywork show it to be piloted by a kor'ui.

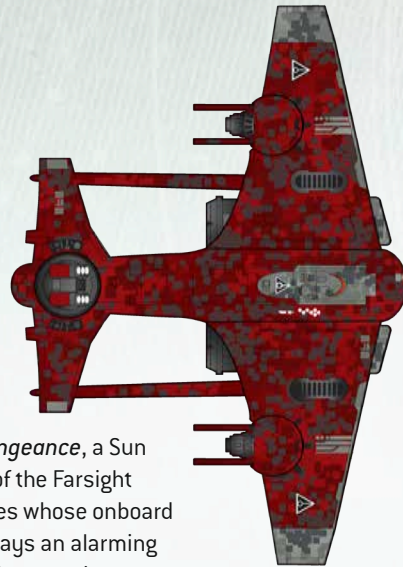

Red Vengeance, a Sun Shark of the Farsight Enclaves whose onboard AI displays an alarming level of aggression



This Razorshark flew during the conquests of the Farsight Enclaves, scouring Ork aircraft from the skies.



This Razorshark, *Grace of Aun'Shi*, bears the colours and insignia of the Fal'shia Sept.

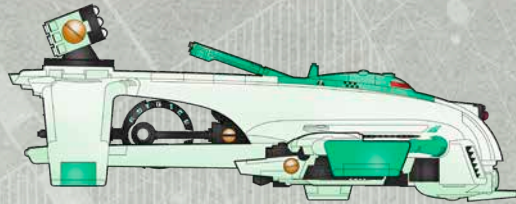

Bringer of Wisdom, an AX39 Sun Shark Bomber of the T'olku Sept Air caste

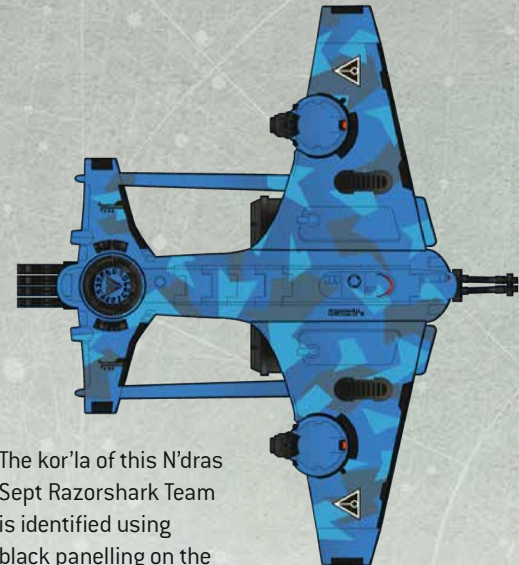

The kor'la of this N'dras Sept Razorshark Team is identified using black panelling on the wing tips.

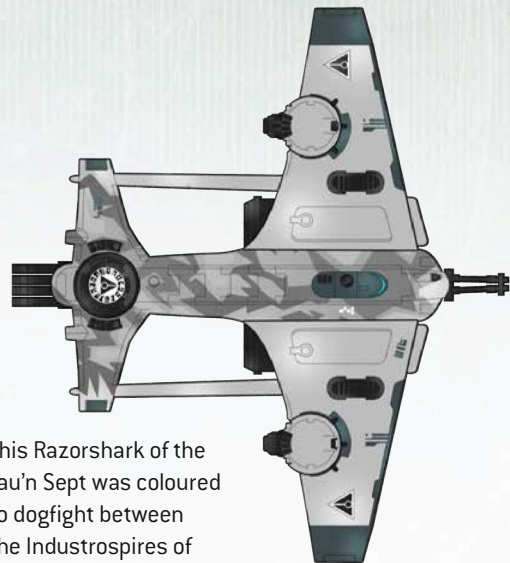

This Razorshark of the Tau'n Sept was coloured to dogfight between the Industrospires of Ghethsemane.

Dal'yth	Fal'shia
Vior'la	Sa'cea
D'ganoi	Bork'an

Each Tau Sept has its own variant of the Air caste symbol, proudly displayed upon all the aircraft and spacecraft of that sept.

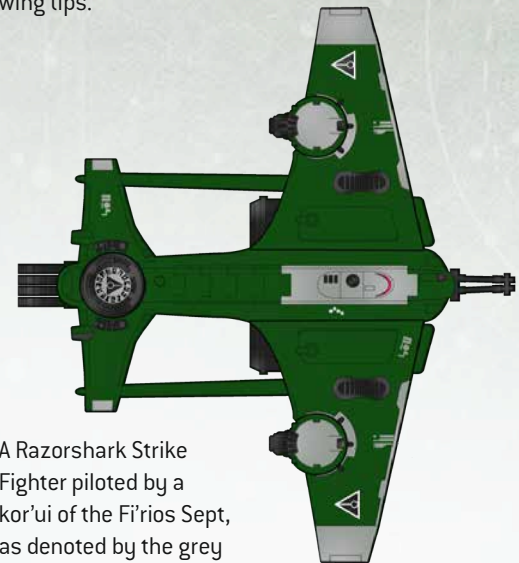

A Razorshark Strike Fighter piloted by a kor'ui of the Fi'rios Sept, as denoted by the grey detail colour

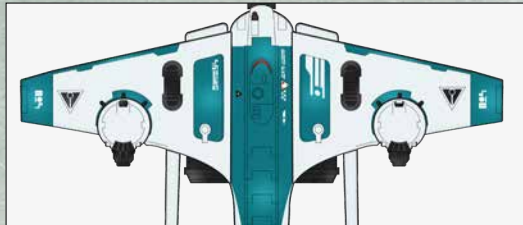
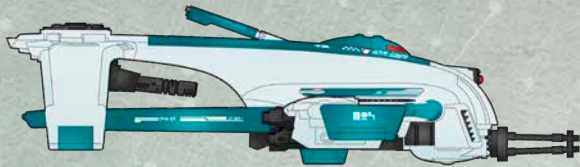

The Bor'kan sept colour is a cool blue, shown here in the unique decoration of this y'eldi.



AX3 Razorshark Strike Fighter *Honour's Due*, showing Vash'ya Sept colours in a hexagonal interference camouflage

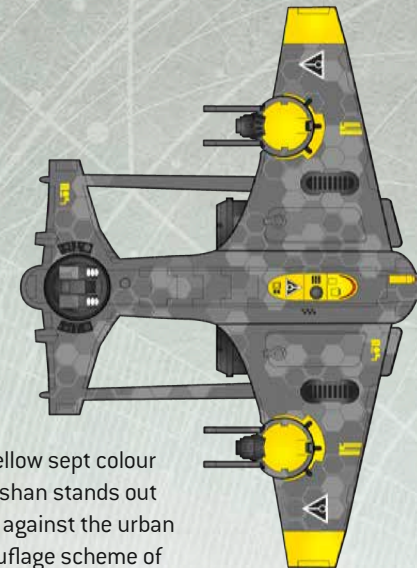

The yellow sept colour of Kel'shan stands out proud against the urban camouflage scheme of this Sun Shark Bomber.



Razorshark Strike Fighter of Bork'an Sept, decorated in arctic camouflage for battle over snowfields

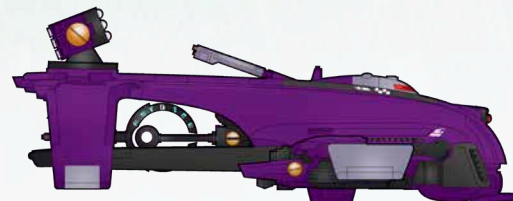

Humbling Blade, the Sun Shark Bomber of Kor'ui Na'mas of the Vash'ya Sept

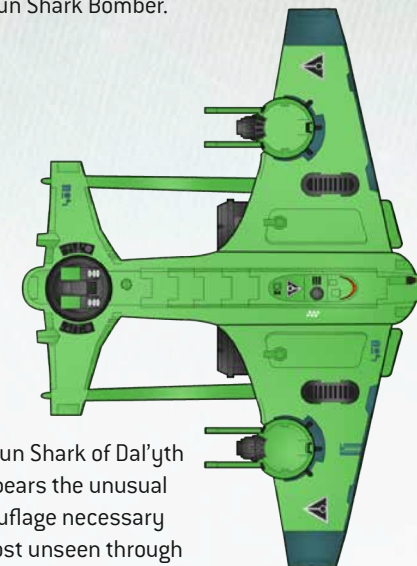

This Sun Shark of Dal'yth Sept bears the unusual camouflage necessary to ghost unseen through the acid fogs of Yugal IV.

Indefatigable, a Sun Shark of the Au'taal Sept renowned for its incredible resilience in battle

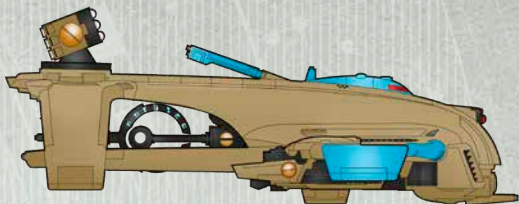
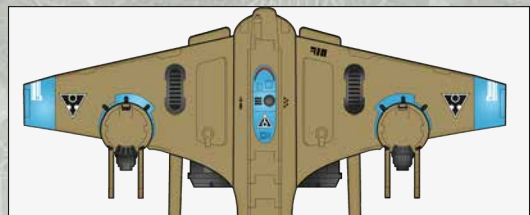
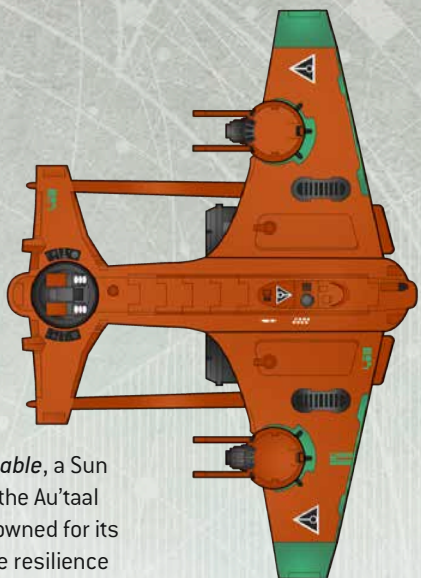

This Sun Shark was piloted by a kor'ui of the D'yanoi Sept during the Dordalion Pacification.

A Razorshark of the Elsy'eir Sept, clad in the bloody crimson of a Commander's honour guard

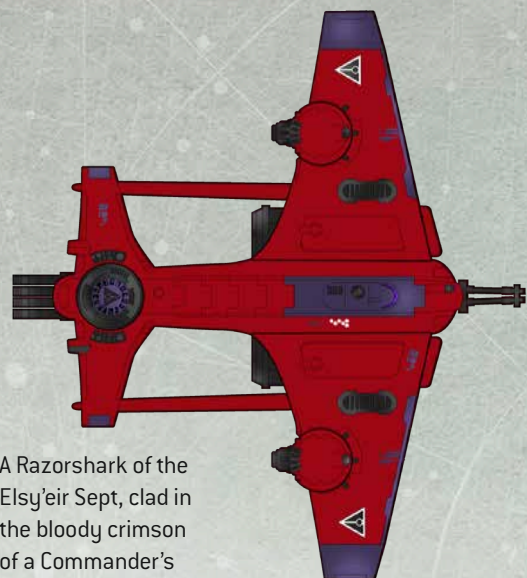

Well known for his heroics during the conquest of Mu'gulath Bay, Kor'ui Bel'shos pilots this Razorshark.

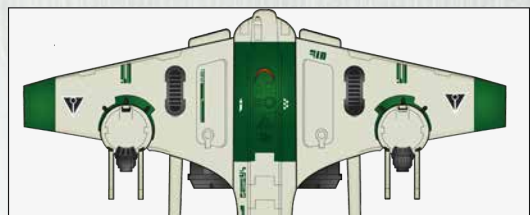
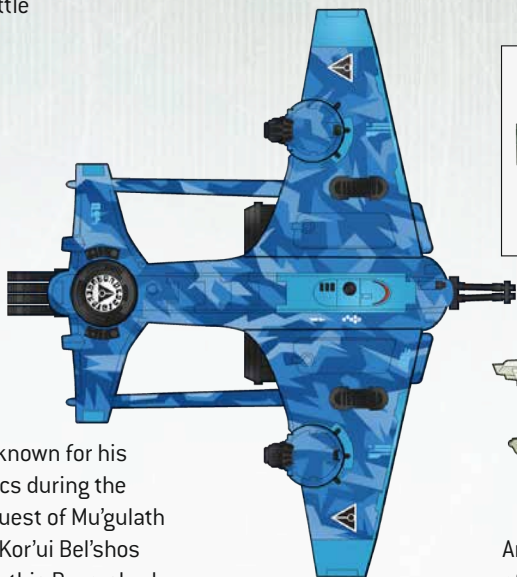

An AX39 Sun Shark Bomber that bears the colouration of the Ksi'm'gen Sept upon its cockpit and wing-tips

A Razorshark of D'yanoi Sept, displaying impressive kill markings upon its fuselage



CRAFTWORLD ELDAR

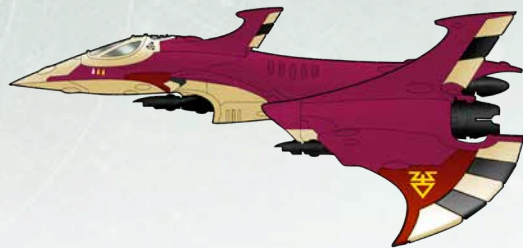
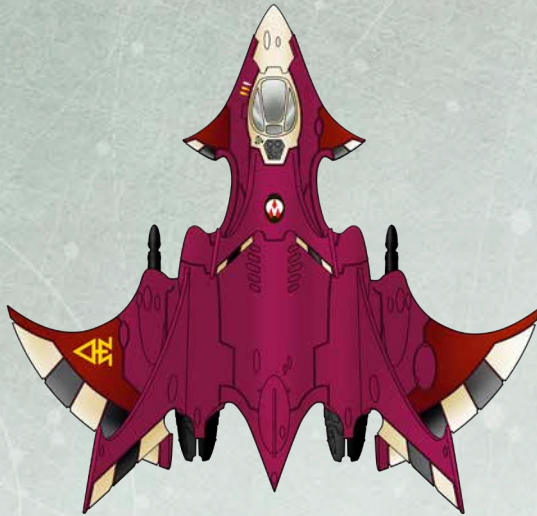

On the Nightshade Interceptors of many Crimson Hunters, the secondary hue of their Aspect Shrine's colour scheme is displayed on the underbelly.



The greatest and most accomplished Ace pilots amongst the Crimson Hunters are the Exarchs of their shrines. These incredibly skilled warrior pilots exemplify the martial excellence and absolute focus of their Aspect Shrines, leading their comrades by example and routinely taking a spectacular toll upon the enemy. Few enemy pilots can match the sheer brilliance of the Crimson Hunter Exarchs, for every iota of the Eldar pilots' minds and souls are attuned purely to aerial combat.



To signify leadership of their Aspect Shrine, some Crimson Hunter Exarchs bear a version of the shrine banner on their secondary stabiliser fins, which is duplicated on their hulls, between the two front fins of the craft.

There are many Crimson Hunter shrines on the Craftworlds, each with their own iconography and banner. With names like the Red Talon Shrine or the Blood of Khaine Shrine, each also has a unique rune, often including mythologically significant blood drops.

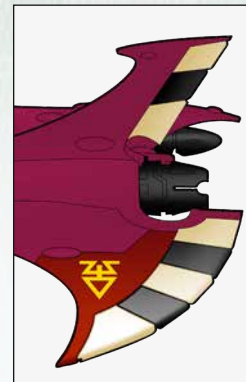
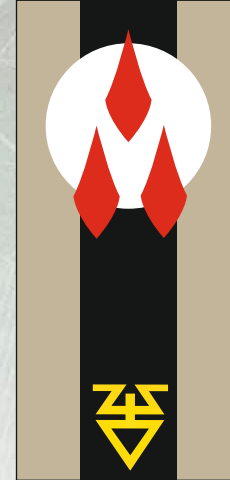

Rank-and-file Crimson Hunters are Aspect Warriors who follow their Exarch into battle. In larger shrines, each wing of Crimson Hunters is denoted by specific arrangements of colours on their wing feathers.

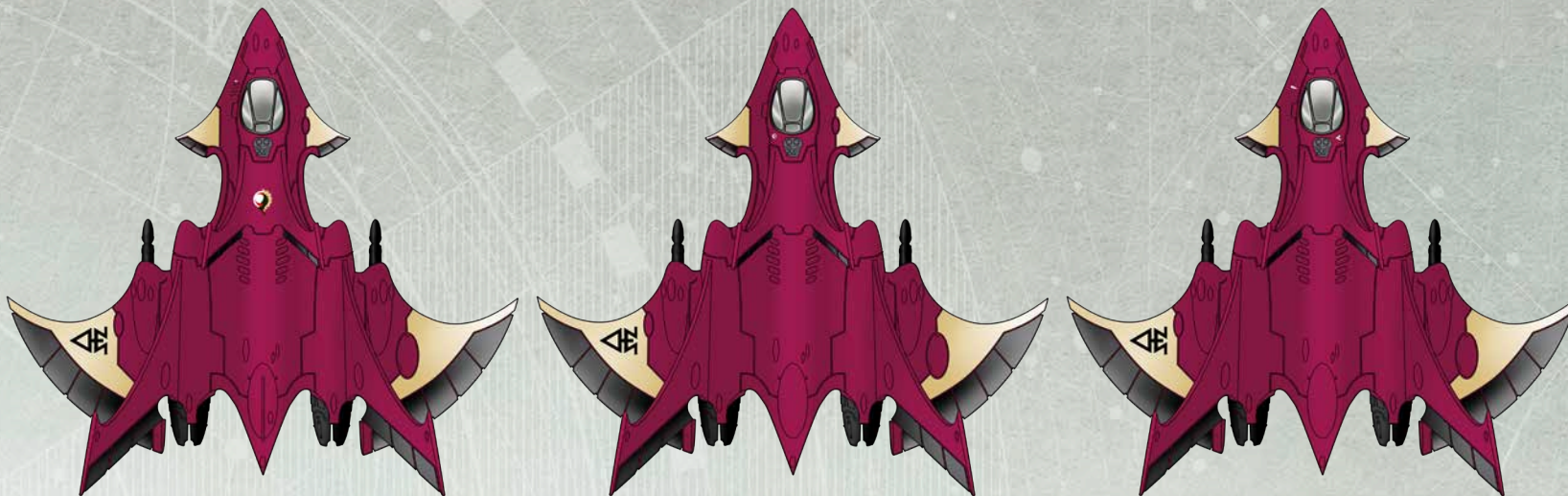

Crimson Hunter Aspect Warriors typically take to the skies in squadrons, commonly known as wings. All Aspect Warriors in a wing bear the colours of their particular Aspect Shrine, in the same way that more conventional Aspect Warriors would. The craft shown above belong to the Shrine of the Ascendant Strike, and were instrumental in the victory over Chaos demagogue Foulmaw's nightmare armada above Vados.

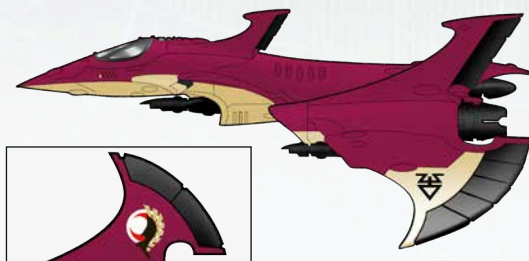

This is the Nightshade Interceptor of Exarch Ilythaindar, greatest pilot of the Shrine of the Ascendant Strike. This masterful warrior fought in the skies over Xul'din, slaying many terrible airborne monsters from the Tyranid swarms.

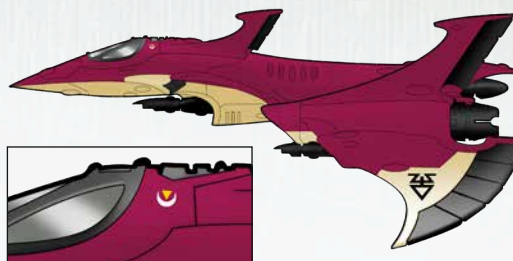

Yal'thir is an Aspect Warrior of the Shrine of the Ascendant Strike, and Exarch Ilythaindar's trusted comrade over many decades of war. He bears an honour marking beside his cockpit, the rune of Khaine's Wrath showing his ferocity in battle.

Shown here is the banner of the Shrine of the Ascendant Strike. Combining a stylised representation of the mythological Faolchú's wing feathers, the design overlays the backdrop of the hunter's moon and is framed upon a field of blood red. These warriors soar upon the wings of Faolchú as the hunter's moon hangs ascendant over all.



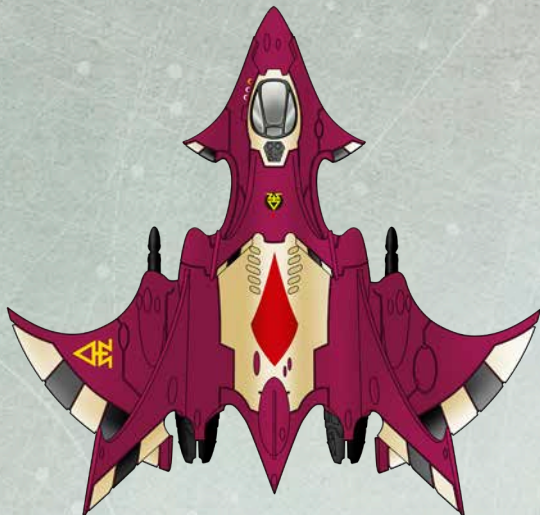

This is the craft of Exarch Norohil, his personal honour-marking emblazoned upon the hull.

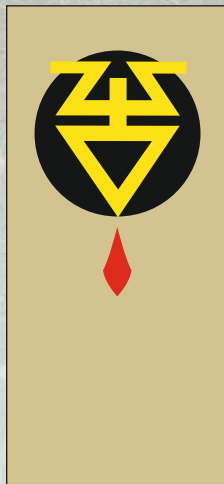

The craft of Shenrath, an accomplished Exarch of the Bloodwrought Barb Shrine



Norohil, Exarch of the Scions of Kuron Shrine, has the honour of bearing the stylised blood drop of Khaine upon his craft, signifying that he has slain more foes than the dead gods have sorrows.

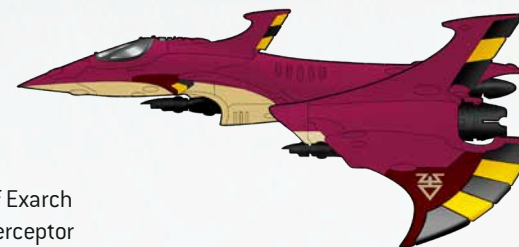

The deep crimson wings of Exarch Shenrath's Nightshade Interceptor signify the dipping of the mythic hawk's pinions in the blood of slain foes.

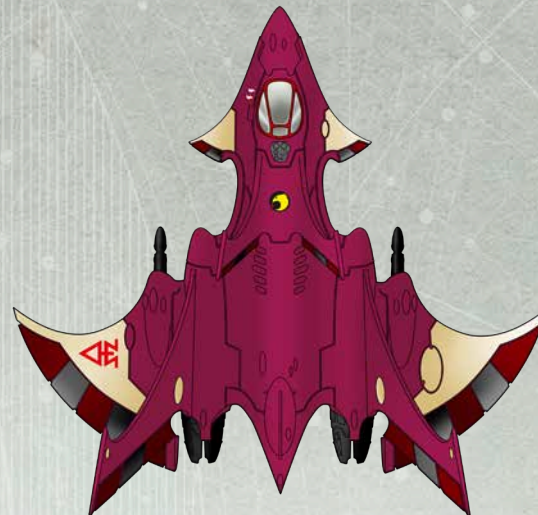
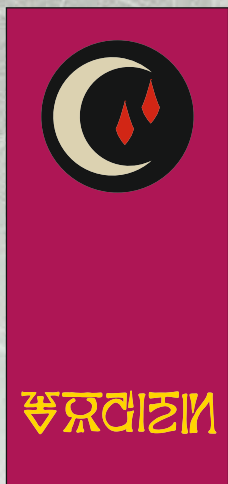

This infamous Nightshade Interceptor is piloted by Exarch Valos'har, the Living Blade. Such is the Exarch's skill in aerial combat that she is said to fence with her aircraft the way a master swordsman will lunge and parry with their steel.

Exarch Lethraen, first amongst the Crimson Raptors Shrine, pilots a noble craft named *Starsorrow*. The bone-coloured panels upon the craft's hull signify not only the Eldar lives that were lost during the gruelling aerial war on Inferredul, but the mortal vengeance that Lethraen and the Crimson Raptors wrought upon their savage greenskin enemies.



The black accents upon the Living Blade's craft are a mark of funerary respect for her enemies. They are considered already dead the moment they engage the Exarch in battle.



Exarch Lethraen slew the Malyr Twins, a pair of exceptional Dark Eldar pilots who had slaughtered hundreds of their Craftworld kin. The kill markings under Lethraen's cockpit denote this.





The Eldar Craftworld of Saim-Hann is famous for its hot-headed pilots, who revel in high-speed aerial combat. Even the Spiritseer pilots of its Wraithfighters are notoriously wild with their psychic assaults.



This Hemlock Wraithfighter is named *Heg's Blade*, and belongs to the wing known as the Sorrowserpents. It is considered a herald of ill omen, though normally only for its pilot's foes.



The white nosecone on this craft denotes that it belongs to the Saim-Hann Second Warhost.

1	2	3	4	5	6	7	8	9	10	11	12
▼	▲	▼▲	◆	◆◆	◆◆◆	◆◆◆◆	◆◆◆◆◆	◆◆◆◆◆◆	↓	↑↓	▲

The ancient Eldar language includes many complex numerological systems. This one, the Signs of the Soul, is often used upon Hemlock Wraithfighters.



Typically, the Signs of the Soul shown above are applied to the rear stabiliser fins of Hemlock Wraithfighters.

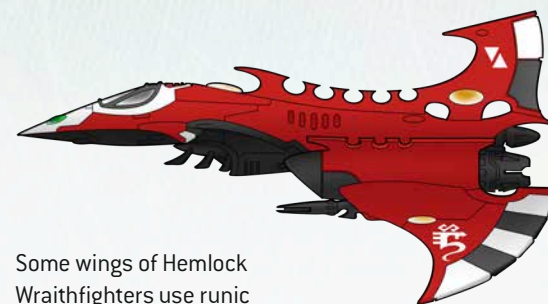

Some wings of Hemlock Wraithfighters use runic designations to denote their place within their wing. This craft displays the rune for 'two', showing it is the second craft in its wing.



This craft bears lyanden's traditional colours.

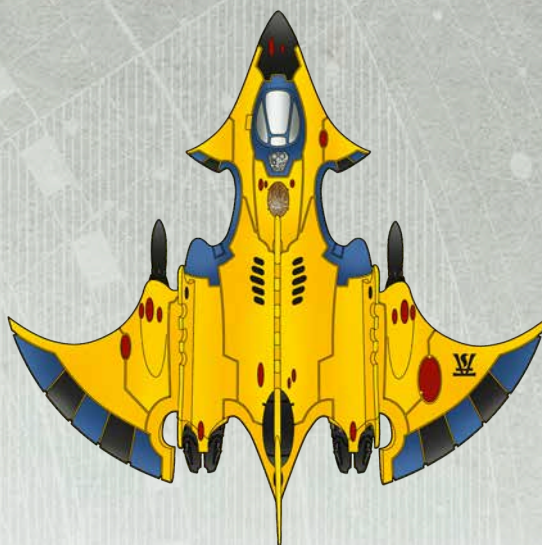

Hemlock Wraithfighter of the Falling Moon Shrine

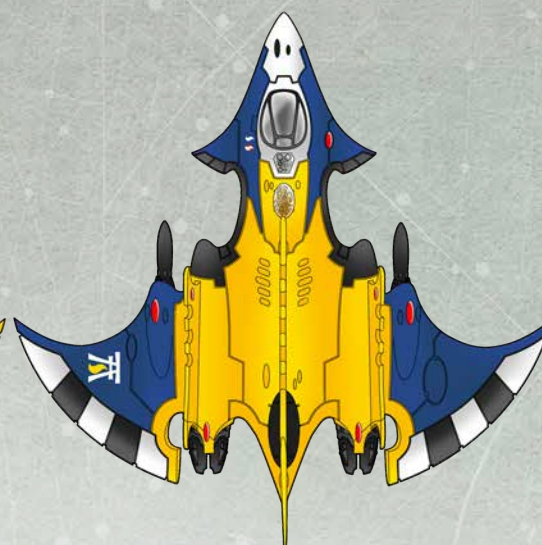

This Second Warhost Wraithfighter slew the renowned Red Knight over Fendark City.

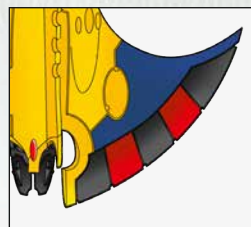
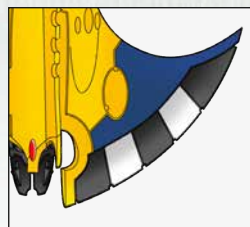
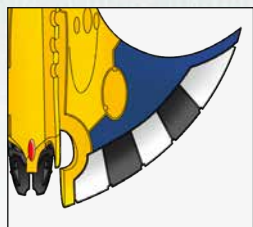

Widely varying patterns of colouration on the wing feathers of Hemlock Wraithfighters denote which aircraft wing they belong to.



Craftworld Lyanden has suffered terrible losses in the past, and is heavily reliant on wraith constructs, Hemlock Wraithfighters amongst them. The Spiritseer pilots of these strange craft control psychic terror weapons without compare.



The lost son of Lyanden, Prince Yriel, left his home to become a Corsair lord, only to return in the Craftworld's darkest hour. The craft depicted here belongs to Warlock Dethrian, one of Prince Yriel's infamous Eldritch Raiders.





This is the Hemlock Wraithfighter *Shadow*, an ancient craft that hails from Craftworld Ulthwé.



On some Hemlock Wraithfighters, the pilot chooses to display the stark and ominous hemlock rune instead of their wing number. It is said to be a ward of protection for both the pilot and the souls that have been torn from the heart of the craftworld once more.



The bone and red canopy trim on this craft denotes a pilot who has escaped certain death.

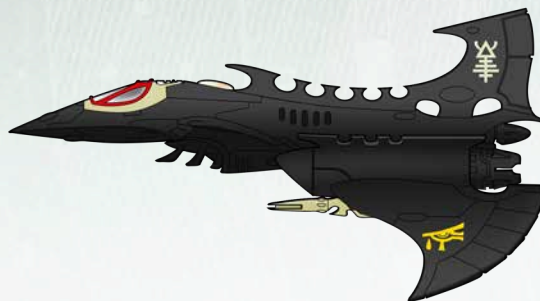

Hemlock Wraithfighters generally have black underbellies. On the already black craft of Ulthwé, this makes for a doubly menacing aspect.



Ulthwé's Wraithfighter wings use a wide array of colourful wing-feather markings.



Eldar hazard markings of this sort are found on aircraft and war machines, warning of dangerous energy sources or emissions.



This craft bears multiple kill markings from the war over Gravenshade.



Many pilots of Craftworld Alaitoc favour a disruption pattern to confuse the eyes of their enemies.



This craft's red canopy trim bears the colour of the Throne of Morai Heg, a sign of martial honour.

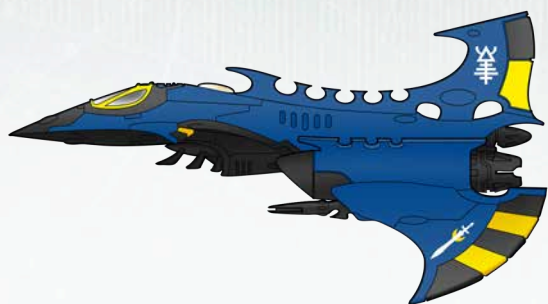

The Hemlock Wraithfighter *Destiny's Due*, of Craftworld Alaitoc. The pilot of this ghostly craft, Spiritseer Thaladair, has chosen to bear the hemlock rune upon his tail fin to bring him fortune in battle.

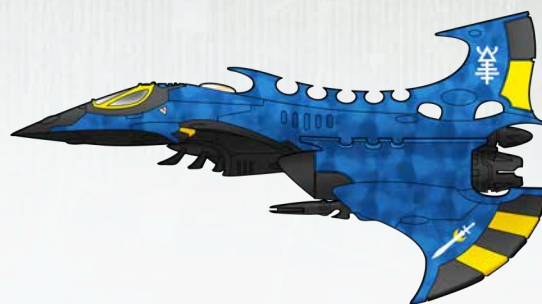

Named *Screaming Sword*, this Hemlock Wraithfighter of Craftworld Alaitoc displays hazard markings around its cockpit and the hemlock rune upon its tail fin. It belongs to the Seventh Hope wing.



For every four kills a Hemlock Wraithfighter pilot earns, they may scribe another kill mark upon their craft. Especially noteworthy kills earn them the doom-laden rune of Khaine's Sword.



The weapons on craft from Craftworld Biel-Tan are often coloured white to signify death.

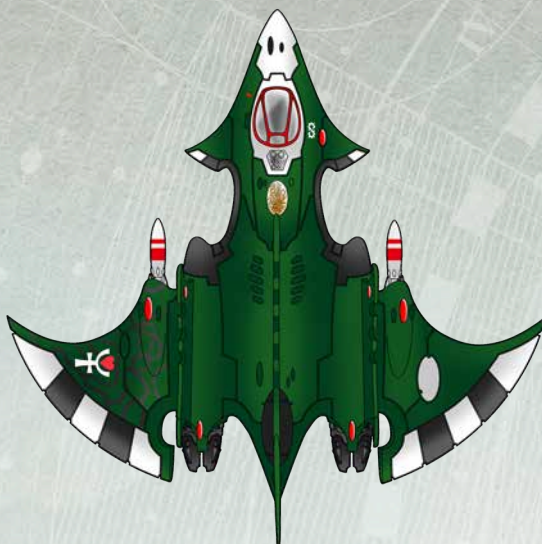

Those Biel-Tan pilots who score impressive kills earn coloured kill-rings upon their weapon cowlings.



This masterful pilot has had her craft decorated with the vines of Biel-Tan, relocating the Craftworld rune.

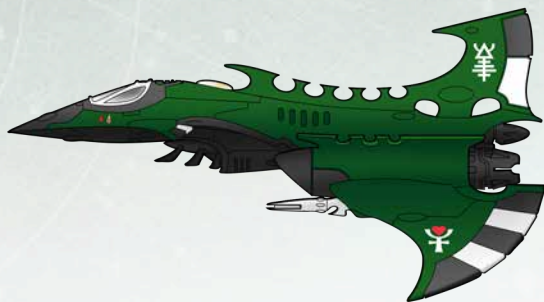

This Hemlock Wraithfighter of Craftworld Biel-Tan flew during the vengeance raids upon the Imperial world of Khadengast. Its pilot claimed the life of no less than the planetary governor himself as the man tried to escape in an Aquila Lander.

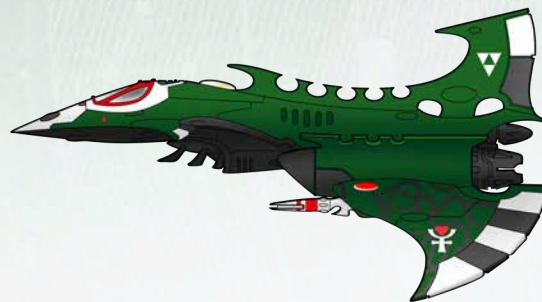

Third amongst his wing, Warlock Kaithrian of Craftworld Biel-Tan is well known for his heroism and selflessness in battle. On many occasions, his gift of prescience has allowed him to shoot down those who would have slain his squad mates.



The barbed vine is a sacred pattern on Craftworld Biel-Tan, and is often borne upon the hulls of the war engines of the smith-god, Vaul.



Craftworld Yme-Loc

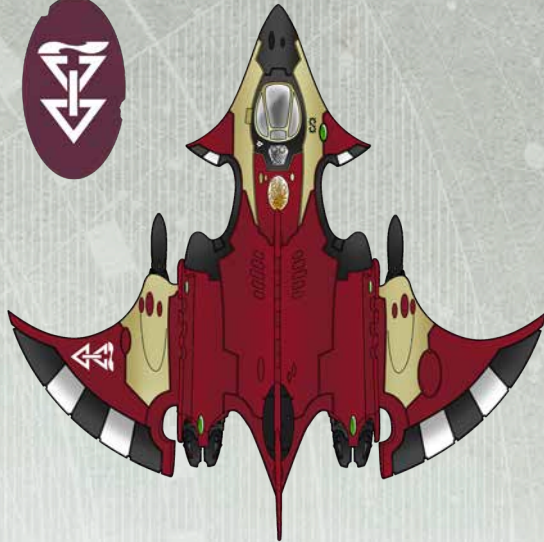

Craftworld Altansar

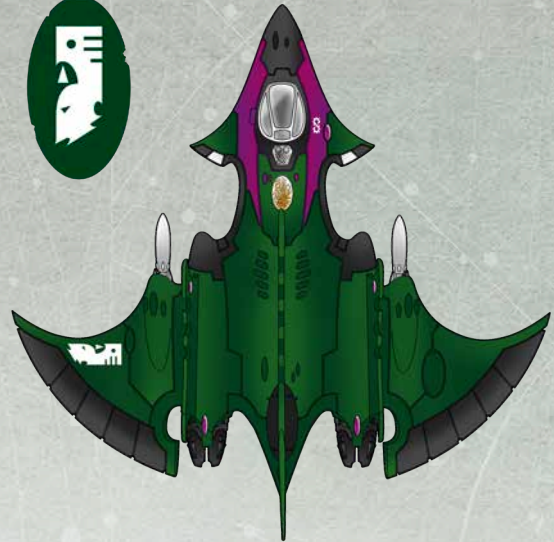

Craftworld Il-Kaithe



Craftworld Iybraesil



Craftworld Lugganath



Warp Hunters Corsairs

HEMLOCK WRAITHFIGHTERS: MINOR CRAFTWORLDS AND CORSAIR RAIDERS

ORKS

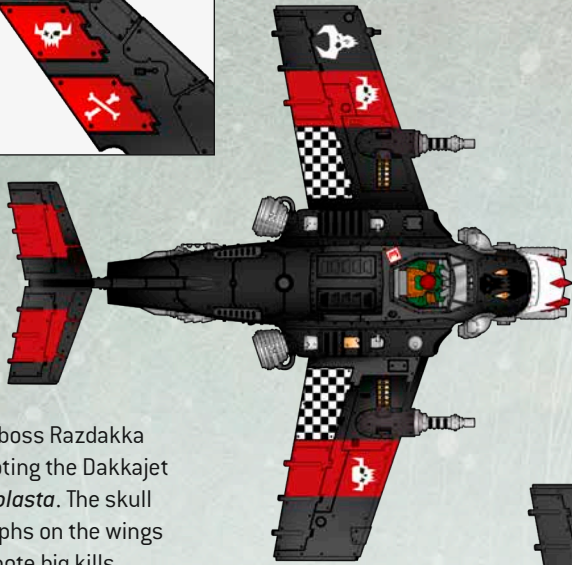

Flyboss Razdakka piloting the Dakkajet *Gitblasta*. The skull glyphs on the wings denote big kills.

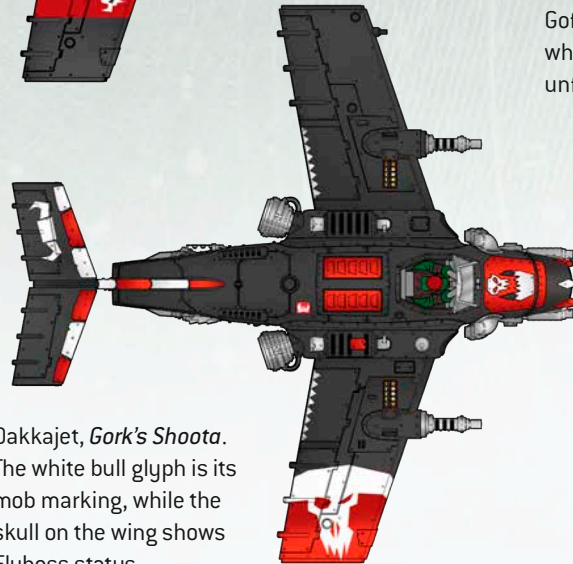
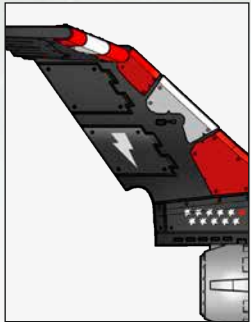

Dakkajet, *Gork's Shoota*. The white bull glyph is its mob marking, while the skull on the wing shows Flyboss status.

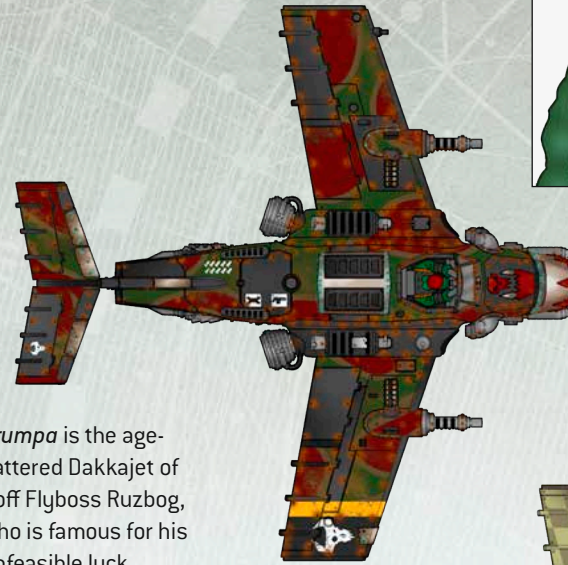

Krumpa is the age-battered Dakkajet of Goff Flyboss Ruzbog, who is famous for his unfeasible luck.

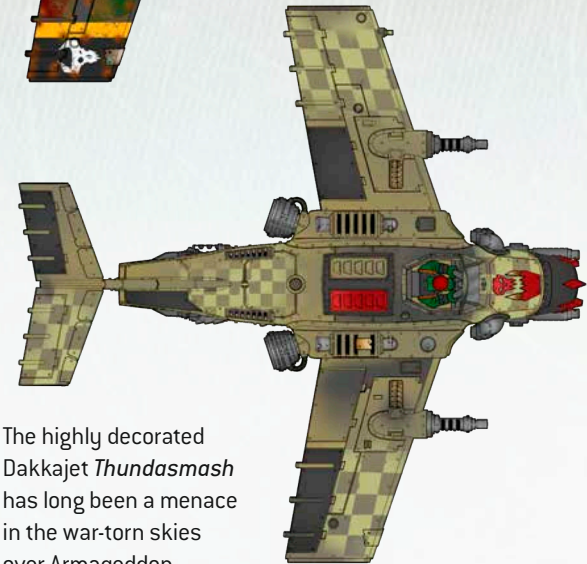

The highly decorated Dakkajet *Thundasmash* has long been a menace in the war-torn skies over Armageddon.



The red checks on this Goff Burna-bommer are crude reflections of the firestorms it leaves in its wake.

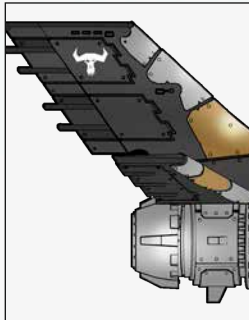

Goff Burna-bommer, *Fundaskorch*, flown by Flyboss Worzog. His mob is denoted by the white band on the right wing.

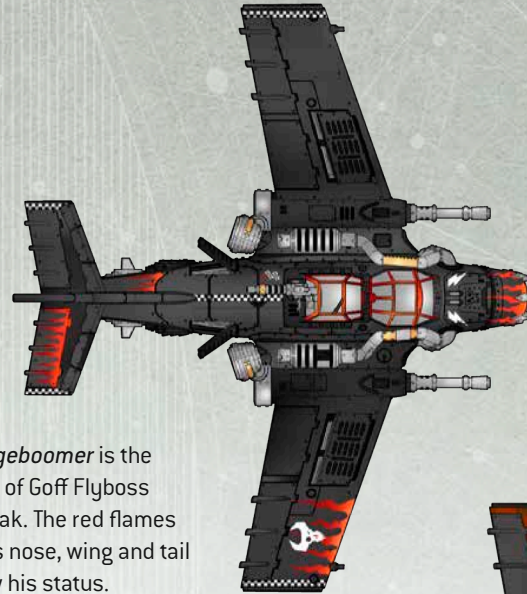
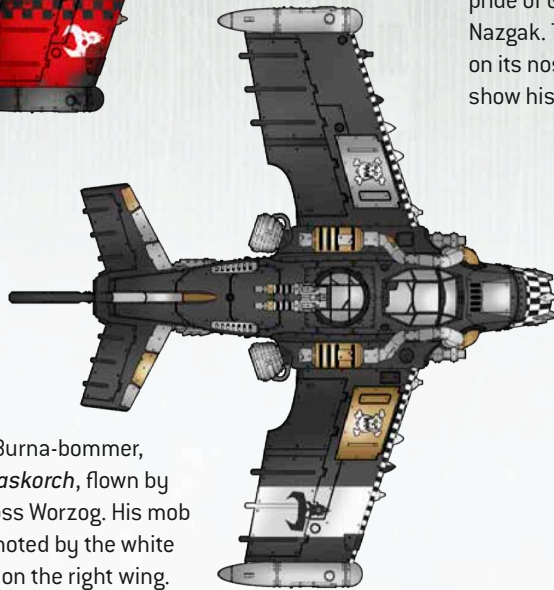

Plungeboomer is the pride of Goff Flyboss Nazgak. The red flames on its nose, wing and tail show his status.

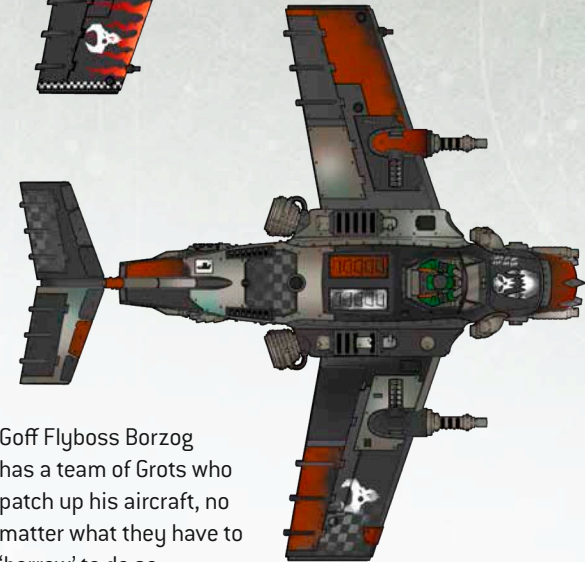

Goff Flyboss Borzog has a team of Grots who patch up his aircraft, no matter what they have to 'borrow' to do so.



Yellow checks on Goff aircraft denote a Flyboy who has earned a lot of teef for a big kill.

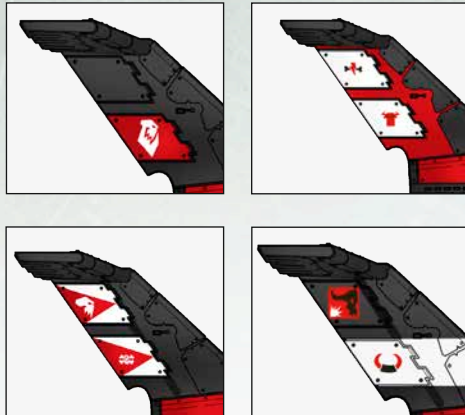

Combinations of colours and tribal glyphs on the tails of Ork aircraft often denote specific Flyboy mobs.



The Goff Clan use bull head glyphs and horned skulls to mark out their mobs and skwadrons.

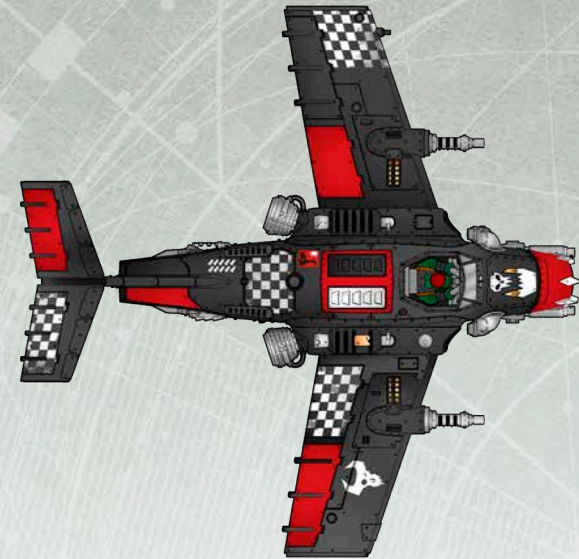

Fist of Gork, the impressive Dakkajet of the notoriously arrogant Flyboss Madskragga

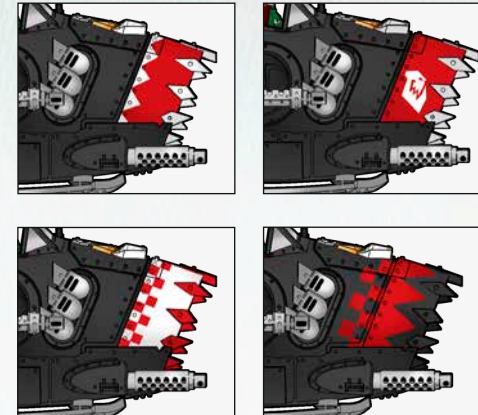

Ork Flybosses often have their craft picked out with obvious designs on the nose as displays of dominance over their mobs.

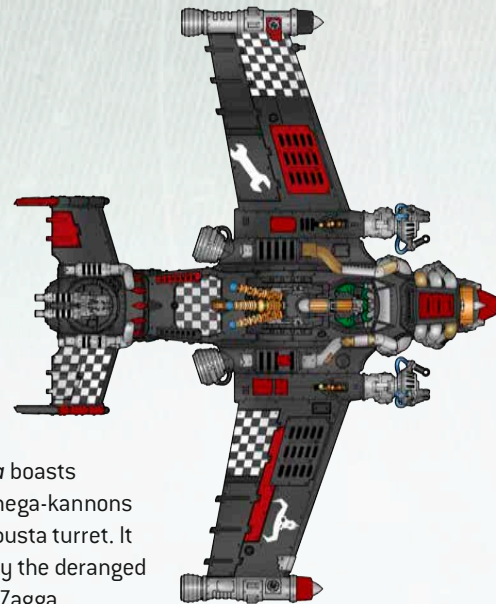

Zagblasta boasts kustom mega-kannons and a gitbusta turret. It is flown by the deranged Mekboss Zagga.

The white patterning on Flyboss Scrapfist's Blitzza-bommer is a crude boast of how mighty he is in battle.

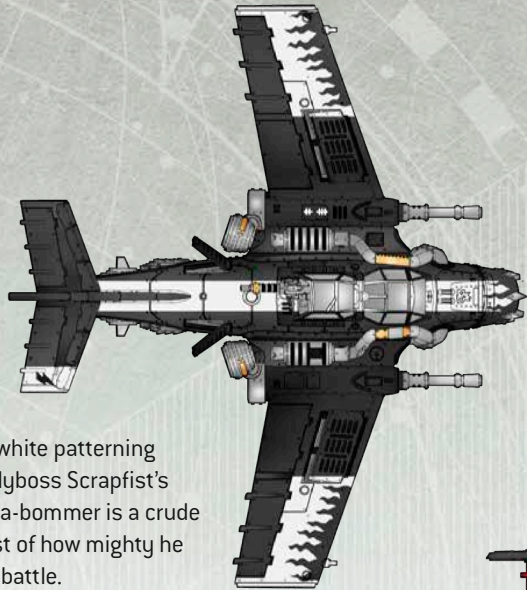

The flame designs on *Da Hammer* show Flyboss status, and threaten the fate of enemies who face it in battle.

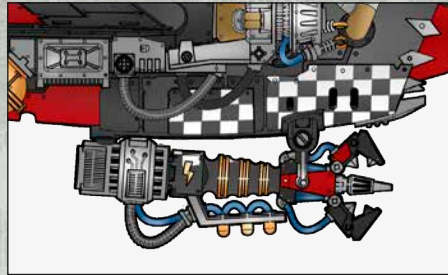
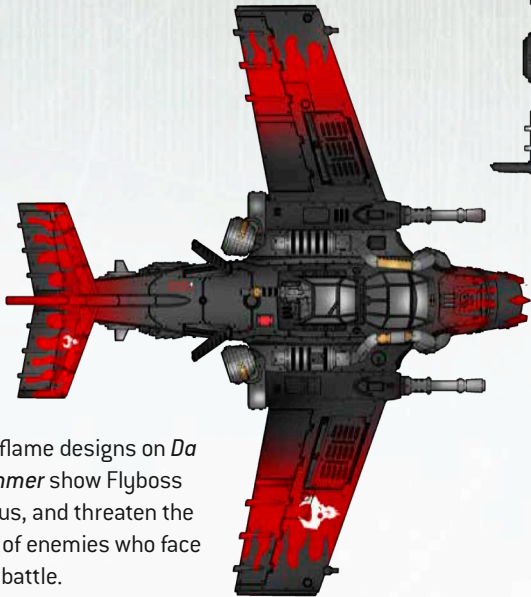

The craft of Mekboss Killbad's mob sport distinctive red panels. The additional white markings show he is the boss of the mob.

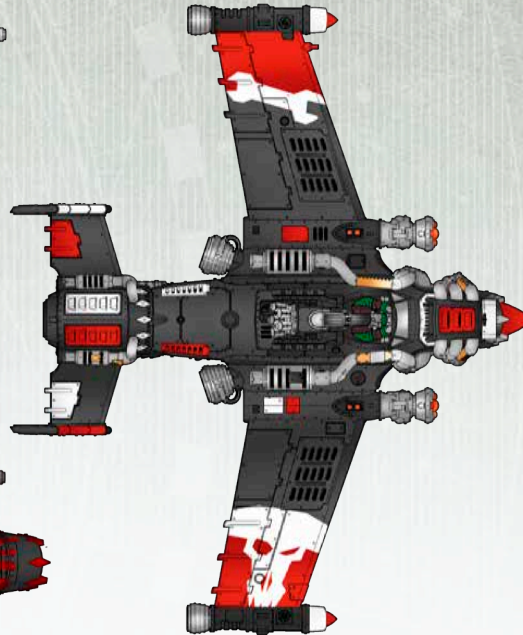

Shootadeath, the noisy, smoke-belching aircraft of Flyboss Drogrek. He claims every check marks a kill.

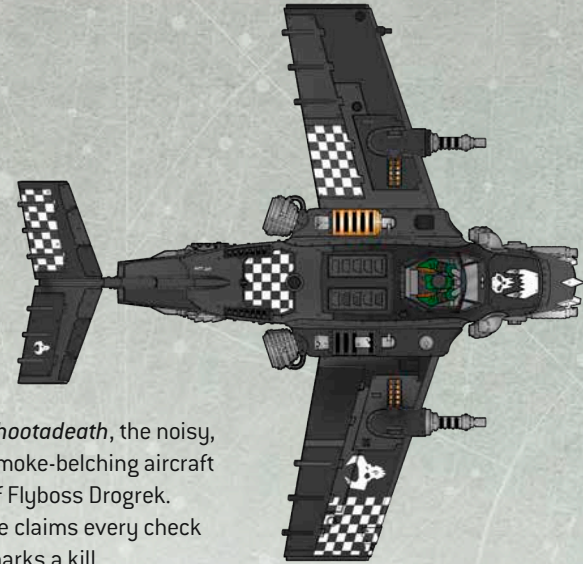

This Burna-bommer, *Vulcha One*, sent the famous *Arc Imperium* plunging in flames into the midst of Korvyn City.



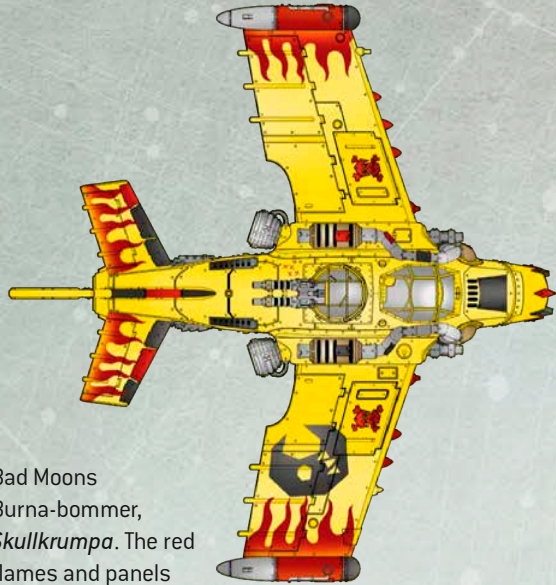

Bad Moons
Burna-bommer,
Skullkrumpa. The red
flames and panels
mark this out as the
mob's Flyboss.

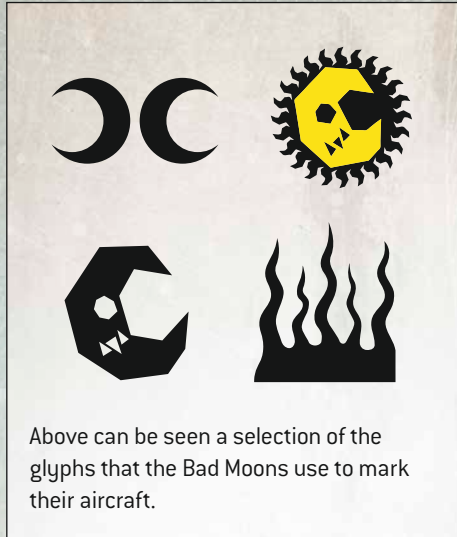

Above can be seen a selection of the
glyphs that the Bad Moons use to mark
their aircraft.

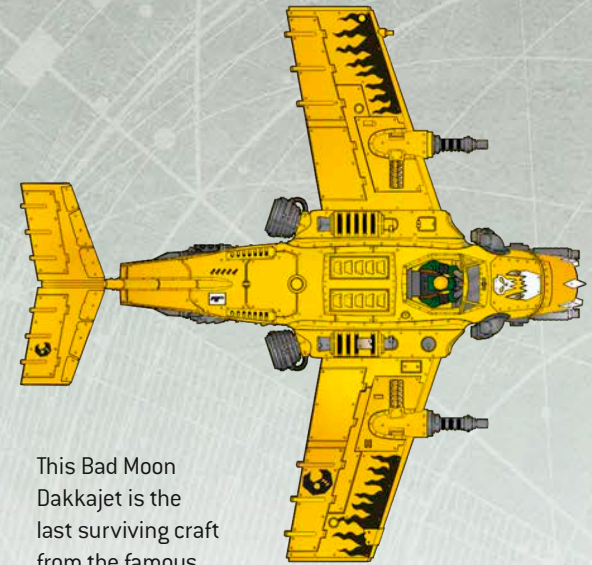

This Bad Moon
Dakkajet is the
last surviving craft
from the famous
but short-lived
Nosediva Skwadron.

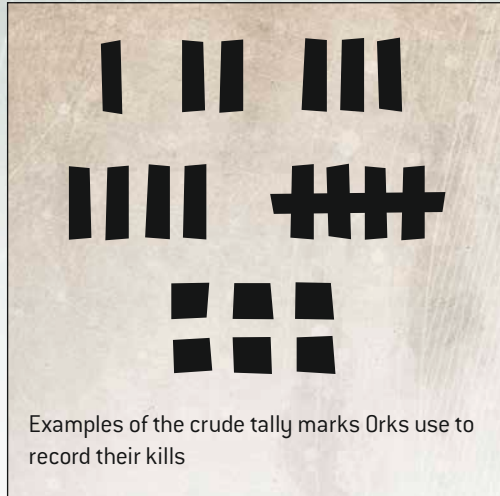

Examples of the crude tally marks Orks use to
record their kills

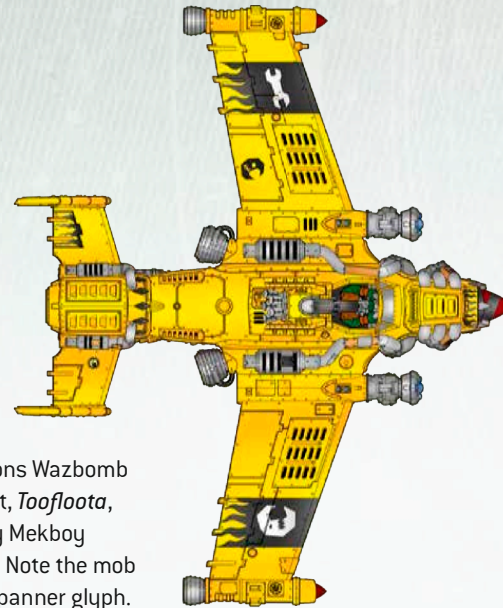

Bad Moons Wazbomb
Blastajet, *Toofloota*,
flown by Mekboy
Zotklaw. Note the mob
leader spanner glyph.

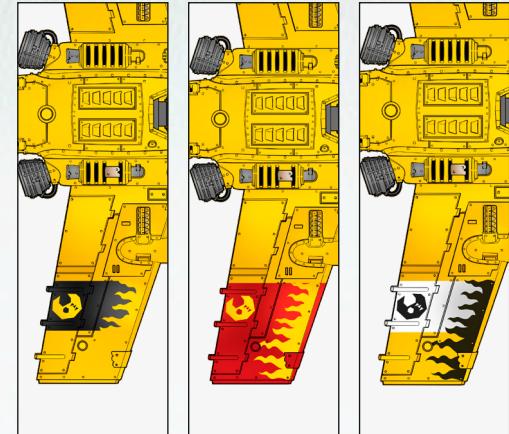

Differently coloured flames or panelling can be
used to mark out different mobs.



Rugrok and his Dakkajet *Sun Gobbler* were the terrors of the war over Gholiam, accounting for many Imperial pilots.



Bad Moons Blitzabomber *Gitwing*, of the Killwrecks. The black flame motif marks out the craft of this mob.

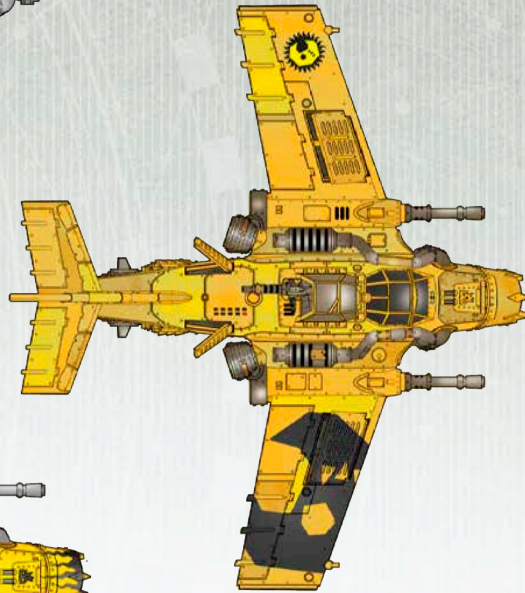
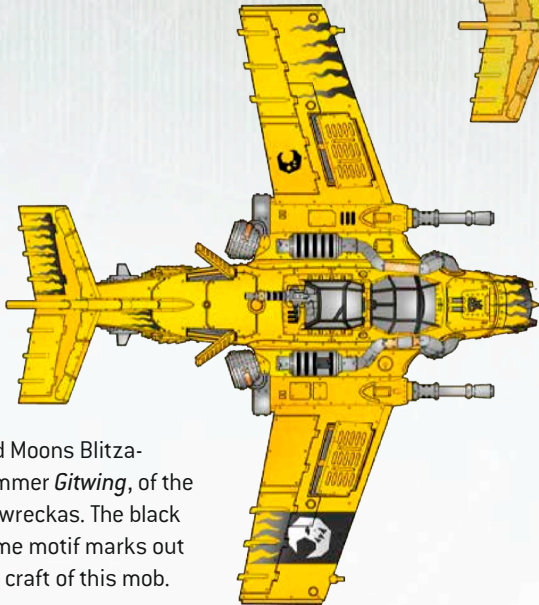

The outsized moon glyph on this Blitzabomber's wing shows that its pilot successfully killed a super-heavy target.



This Dakkajet has multiple kill markings on its nose and hull, earned during the raids over Kilamor Hive.

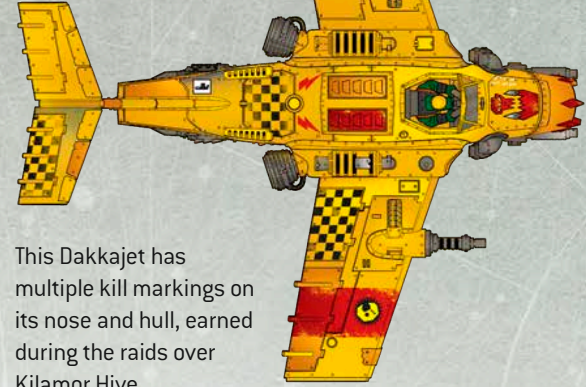

Bad Moons are arrogant about their wealth in teef. The glyph insignia on this craft brag of the pilot's riches.

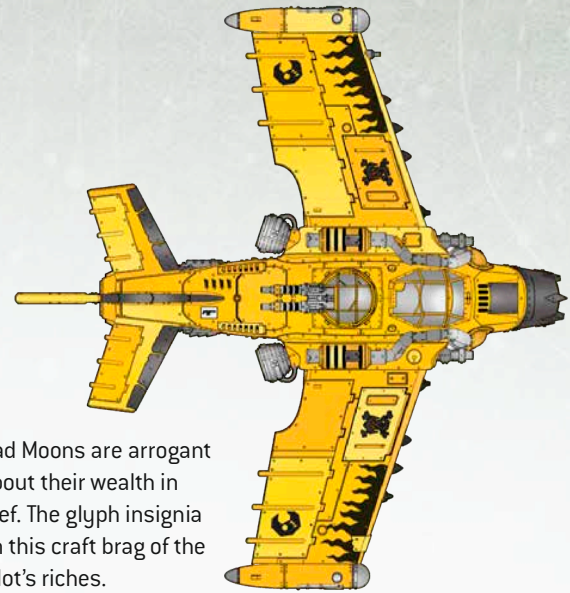



The Evil Sunz paint their planes red as they believe this makes them faster. Amazingly, it seems to work.



The Wazbomb Blastajets in the Red Deff Skwadron have black wing panels with mob and pilot glyphs.



Evil Sunz Dakkajet *Deffscreamer*. Flames on the tail mark it out as belonging to Flyboss Gitburna.

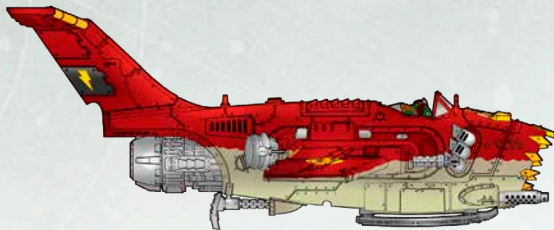

This sneaky Flyboy has camouflaged his craft's underbelly, but kept the top red for speed.



Different mob markings, using varying glyph, band and wing colourations

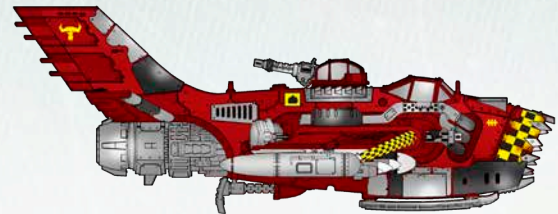

The elaborate decoration and kill markings on this Blitz-bommer show its pilot is a multiple Ace.

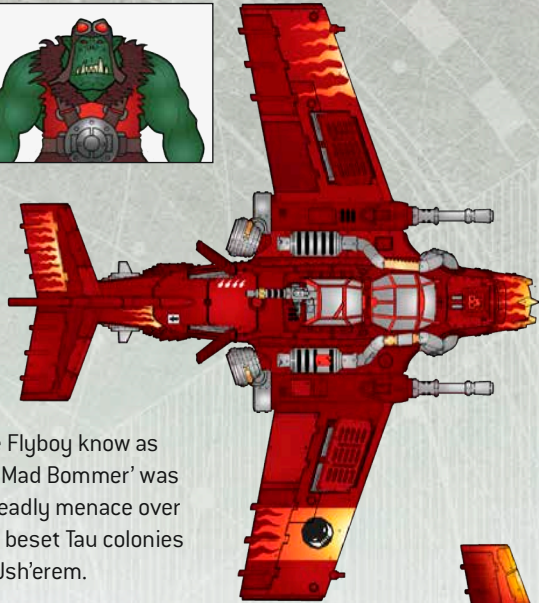

The Flyboy know as 'da Mad Bommer' was a deadly menace over the beset Tau colonies of Ush'erem.

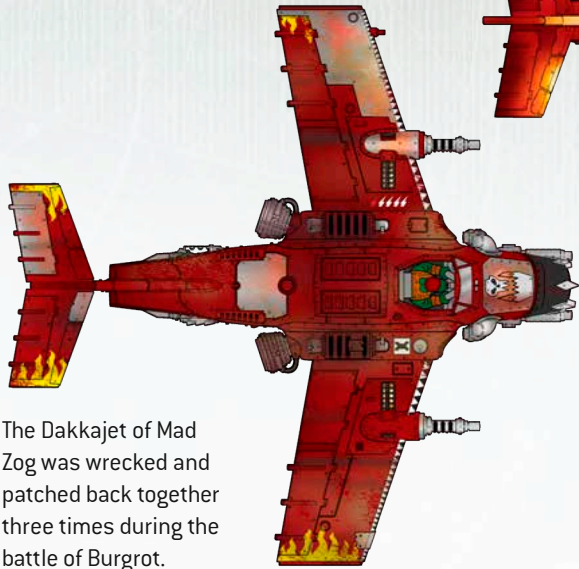

The Dakkajet of Mad Zog was wrecked and patched back together three times during the battle of Burgrot.



Flyboss Narkit and his Blitz-bommer once took out a Warhound Titan, hence the especially flashy decoration.

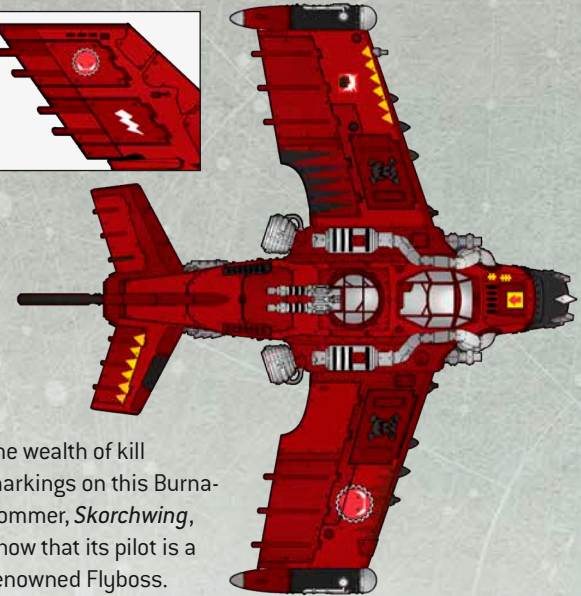

The wealth of kill markings on this Burna-bommer, *Skorchwing*, show that its pilot is a renowned Flyboss.



The notorious pyromaniork Gobrok bears black flames on his wings to show that he is 'da best'.

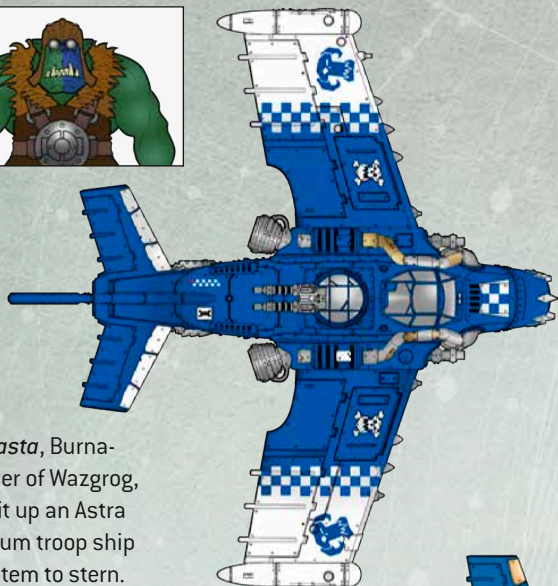

Da Roasta, Burna-bommer of Wazgrog, once lit up an Astra Militarum troop ship from stem to stern.

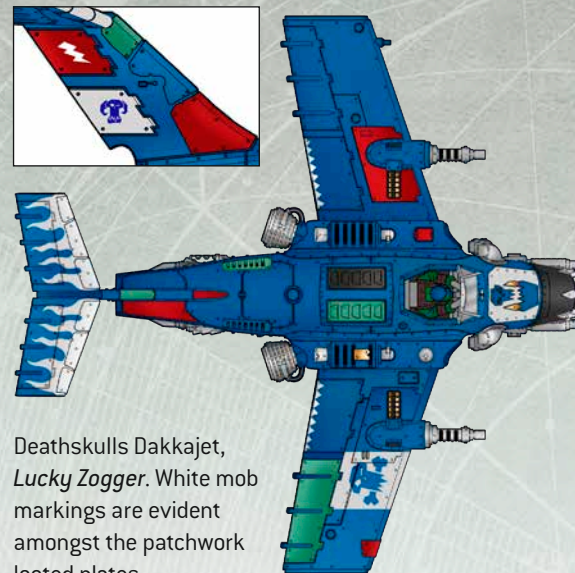

Deaths skulls Dakkajet, *Lucky Zogger*. White mob markings are evident amongst the patchwork looted plates.

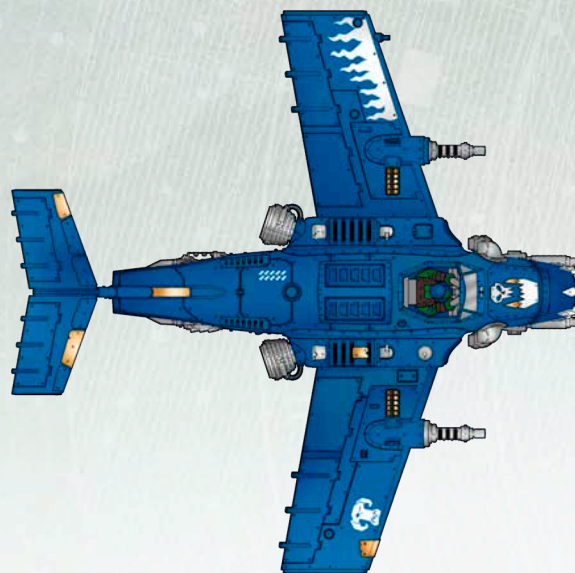

Flyboss Mugrunt shot down ten rival Dakkajets from Gruzgit's tribe – and three from his own – in under an hour.

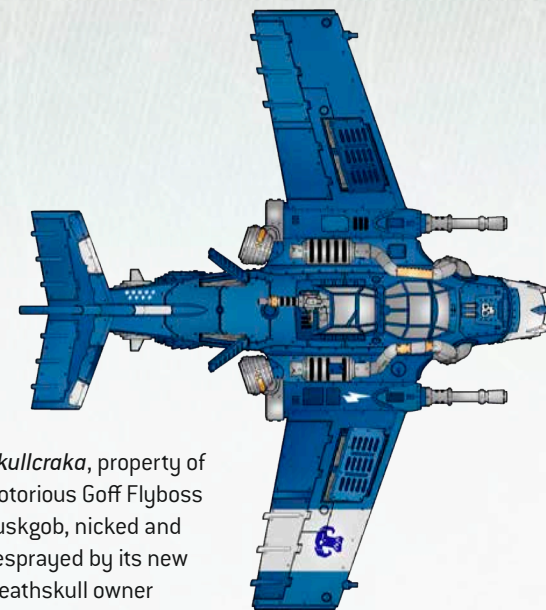

Skullcraka, property of notorious Goff Flyboss Tuskgob, nicked and resprayed by its new Deathskull owner

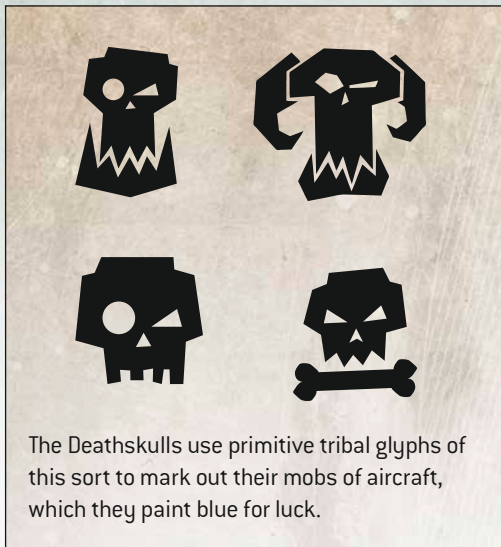

The Deathskulls use primitive tribal glyphs of this sort to mark out their mobs of aircraft, which they paint blue for luck.

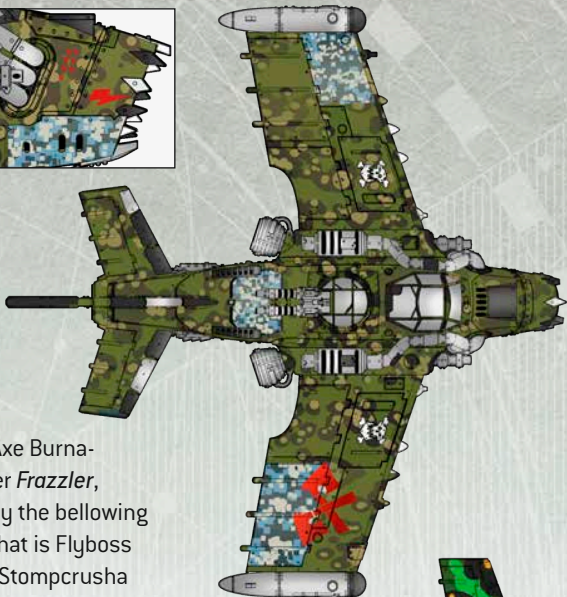

Blood Axe Burna-bommer *Frazzler*, flown by the bellowing terror that is Flyboss Kaptin Stompcrusha

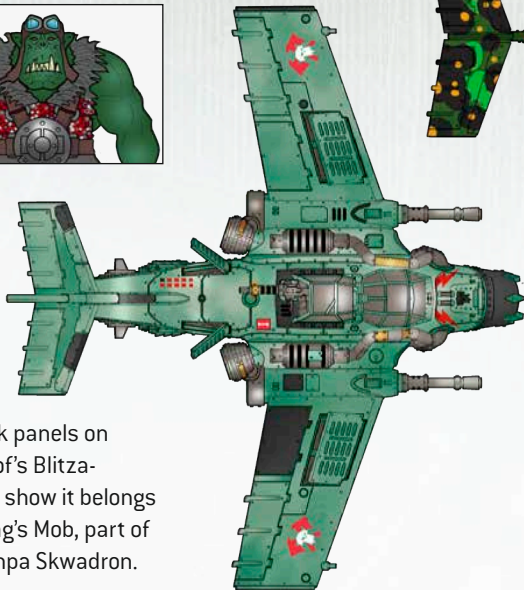

The black panels on Skragtoof's Blitz-bommer show it belongs to Razbag's Mob, part of Skykrumpa Skwadron.

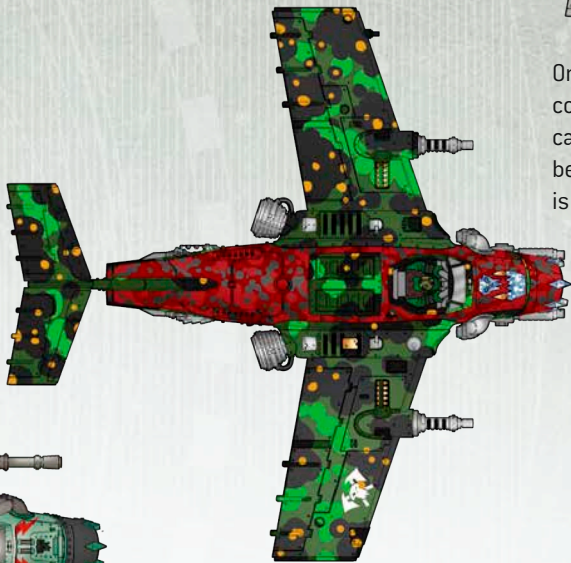

Blood Axes attempt to ape Imperial camo patterns on their craft. The effectiveness of this practice is questionable.

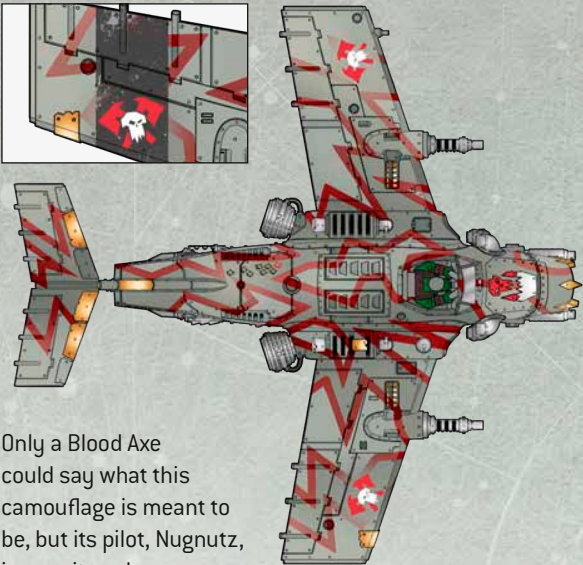

Only a Blood Axe could say what this camouflage is meant to be, but its pilot, Nugnutz, is sure it works.

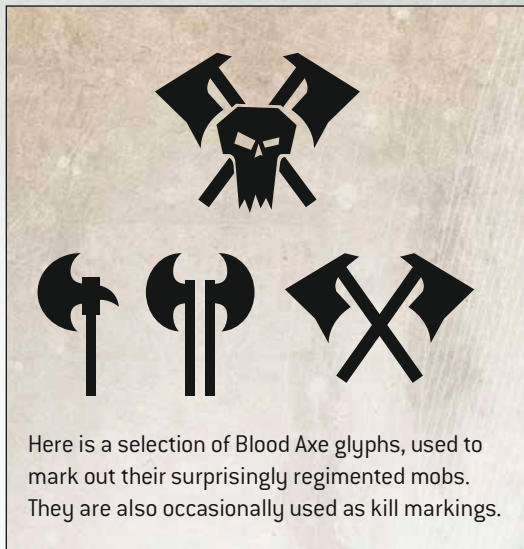

Here is a selection of Blood Axe glyphs, used to mark out their surprisingly regimented mobs. They are also occasionally used as kill markings.

AERONAUTICA IMPERIALIS



Valkyrie Gunship *Defiance*. The colour scheme of this craft shows that it has been seconded to a Cadian regiment.

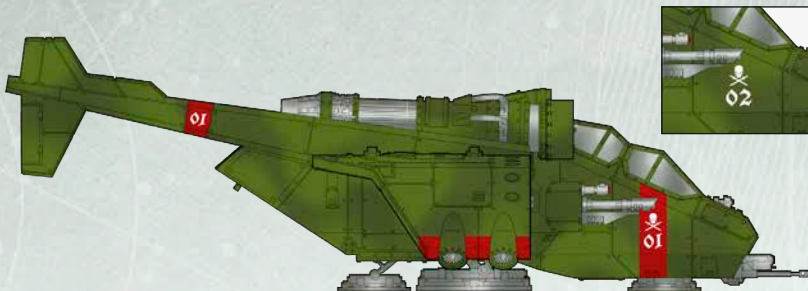

Valkyrie Squadrons are typically denoted with a design such as a skull or crossed blades, and may also bear coloured bands for the same purpose.

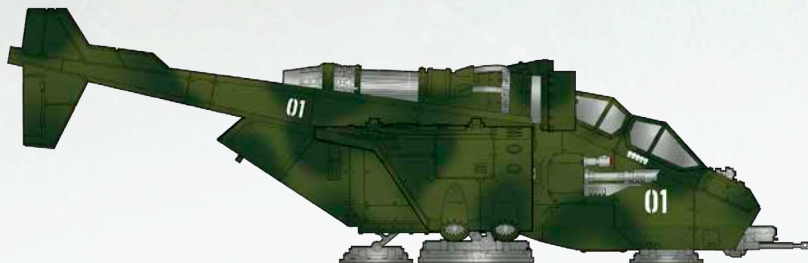

The numeral on the hull of this Valkyrie denotes that it is the first craft in its squadron, and thus the squadron leader.

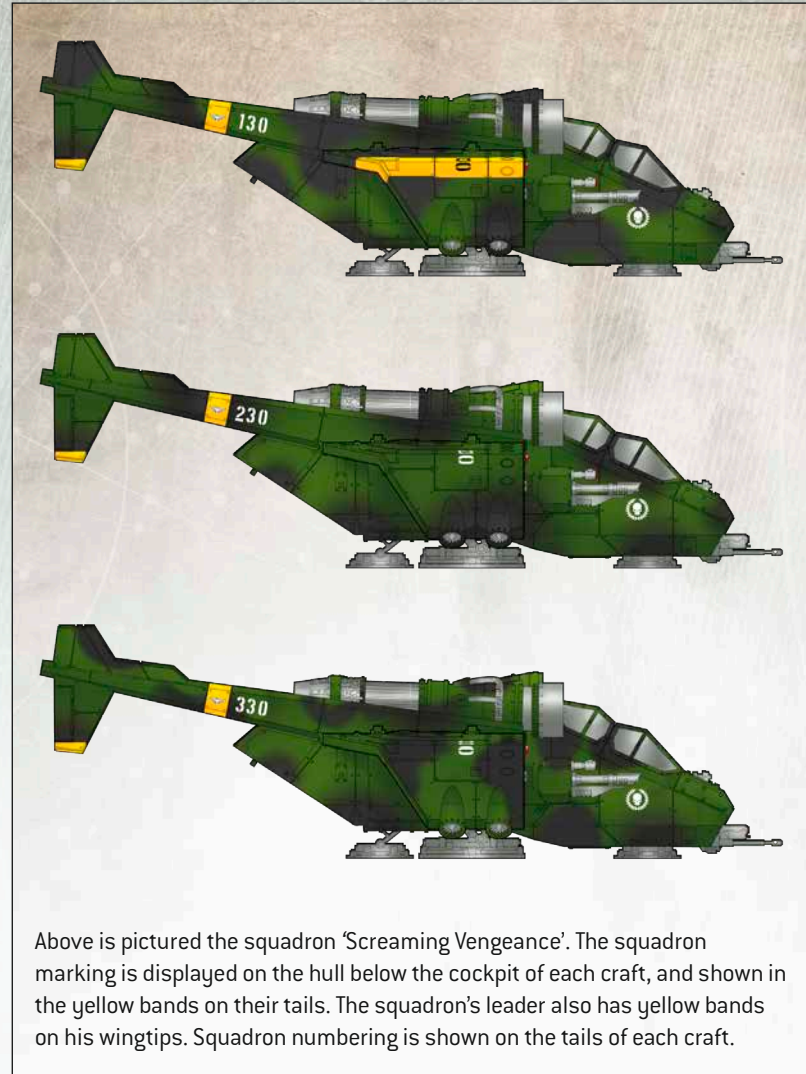

Above is pictured the squadron 'Screaming Vengeance'. The squadron marking is displayed on the hull below the cockpit of each craft, and shown in the yellow bands on their tails. The squadron's leader also has yellow bands on his wingtips. Squadron numbering is shown on the tails of each craft.

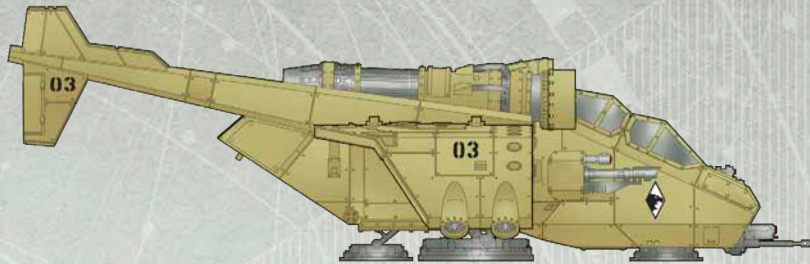

Desert Hawk, 3rd craft in the famous 'Wings of Faith' squadron attached to the Tallarn 14th during the Diablos Campaign

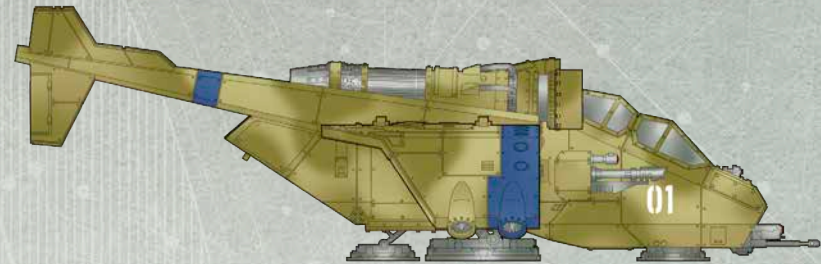

Squadron leader Vasim Khal and his Valkyrie *Sword of Redemption*. This craft became the terror of the Ork skwadrons of Ygolith Minor.

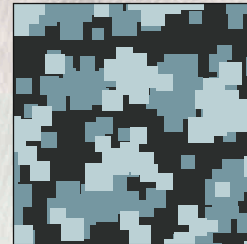
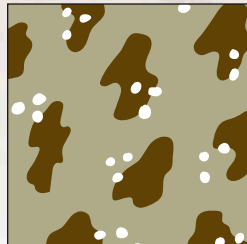
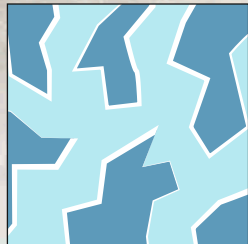

Aeronautica Imperialis squadrons are repainted in whatever colouration best suits the warzone they are sent to, from ice or dust world to jungle or urban camouflage.

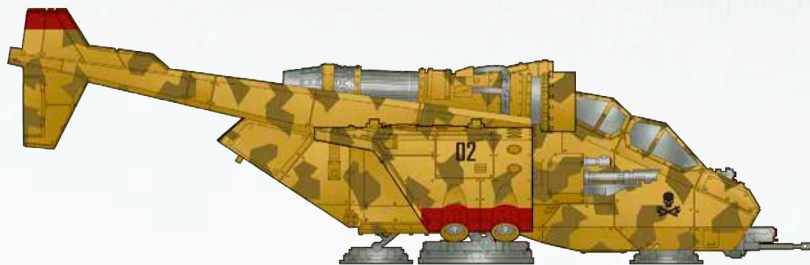

A Valkyrie of 'Orkslayer' squadron. Its camouflage marks the craft out as having been attached to the Armageddon Steel Legion.

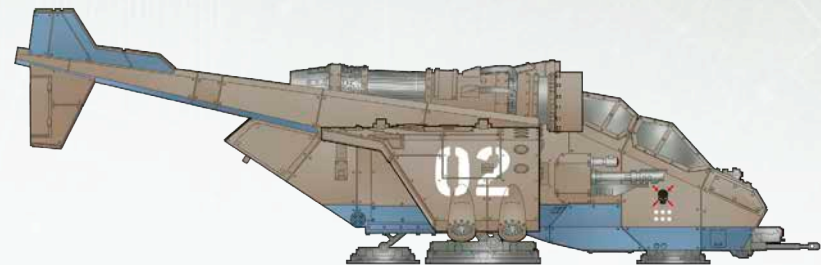

This Valkyrie, *Emperor's Fist*, has had its underbelly painted a pale sky blue in order to make it harder for foes to target from the ground.

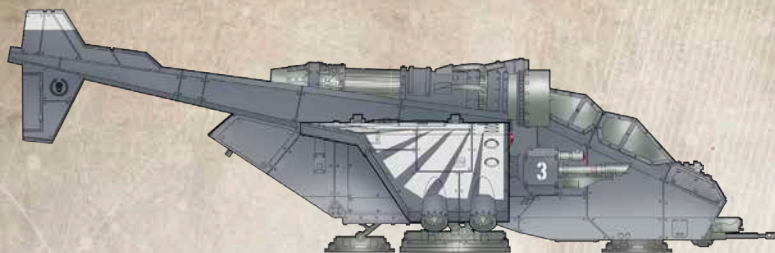

The white pattern displayed upon the wings of 'Virtuous Intolerance' squadron honour their victories during the air war of Thaskamis.

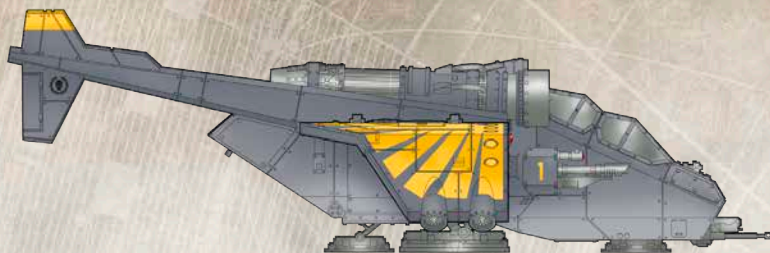

Squadron leader Kallus of 'Virtuous Intolerance' personally shot down a full pack of Helderkes during the final battle over Thaskamis Prime.

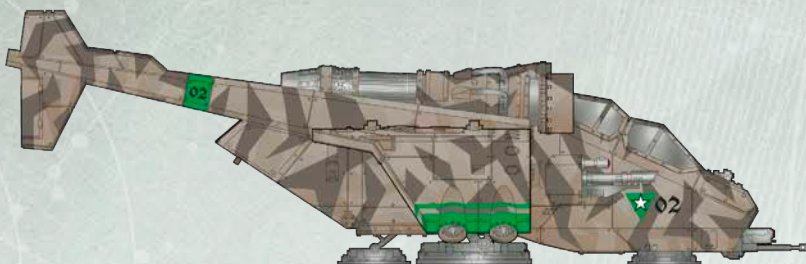

During the retreat from Hesperus, the Valkyrie *Iron Martyr* ferried Colonel Stranski himself to safety after his tank was wrecked by enemy fire.



2nd craft of the 'Sky Vipers' squadron, this Valkyrie displays a fearsome tally of kill markings beneath its cockpit, beside its squadron marking.

SQUAD MARKINGS



Aeronautica Imperialis squadron markings are simple, clear devices, and are usually displayed on the canopy, tailplane or wing of the craft.

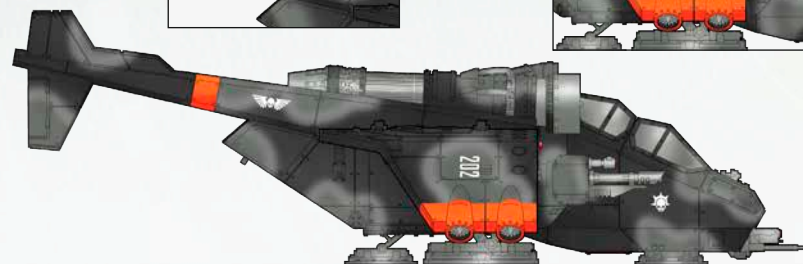
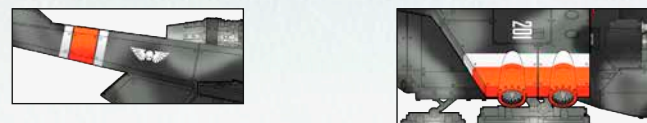

'Brazen Halo' squadron flew on the night world of Urshos. Pictured here is the second craft in the squadron, *Vindictor Maximus*.

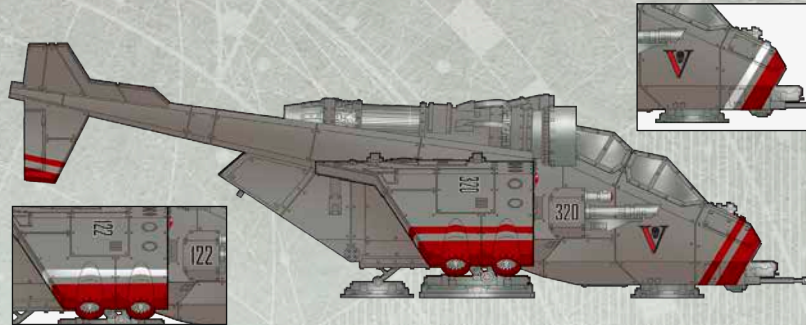

Hymn of Heroes was part of a squadron attached to the Vostroyan 51st Regiment during the fierce fighting on Medusa V.

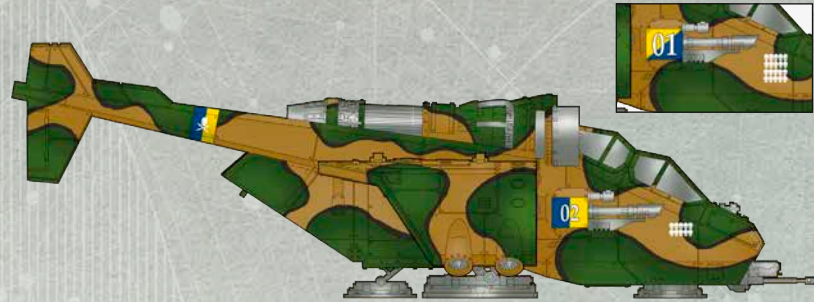

Valkyrie squadrons attached to Catachan regiments display their kill tallies on their cockpits in order to fit in with their new comrades' boisterous warrior culture.

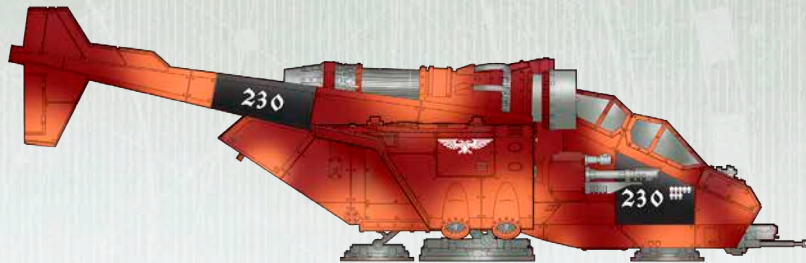

Hero of the attack on the volcanic Pyroxis, flight lieutenant Dortmund shot down the infamous hive dragon, sending its corpse plunging into a live caldera.

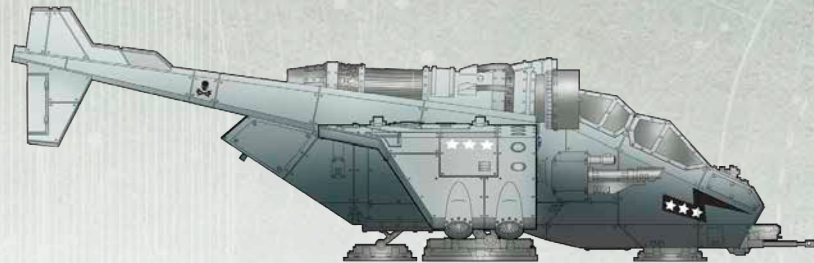

This Valkyrie is unusual in that its squadron marking doubles as its numeral within the squadron, showing one, two or three stars.



Attached to the Mordian 865th during the big push on Klein's World, *Blackwasp* of 300 Squadron reaped a great tally in enemy lives.

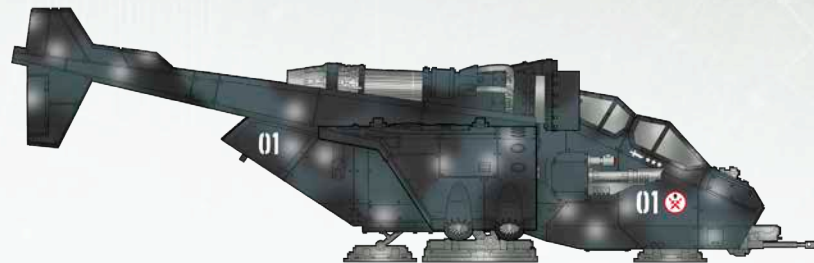

The 'Red Scimitars' were part of a ten thousand strong aerial spearhead that swept clear the aerospace over Drop Site Theta on Nassos.

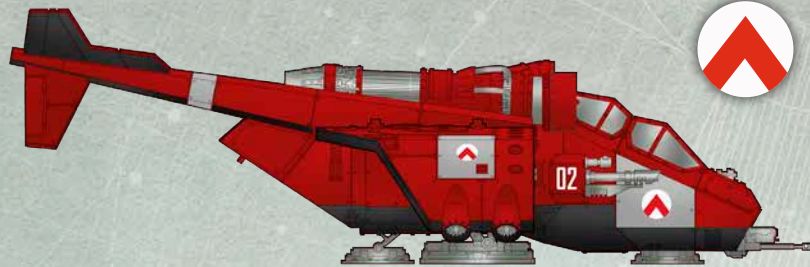

Seconded to permanent operations with the 133rd Militarum Tempestus Lambda Lions, the Valkyrie *Ballista* has shot down countless foes.

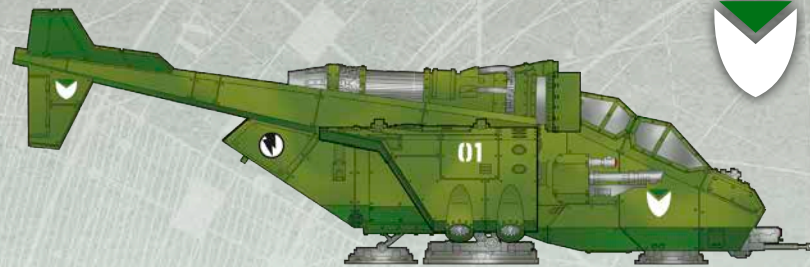

This Valkyrie, *Glorious Repugnance*, bears the livery of the notoriously anti-psyker 62nd Rhoin Cobras, to whom it is attached.

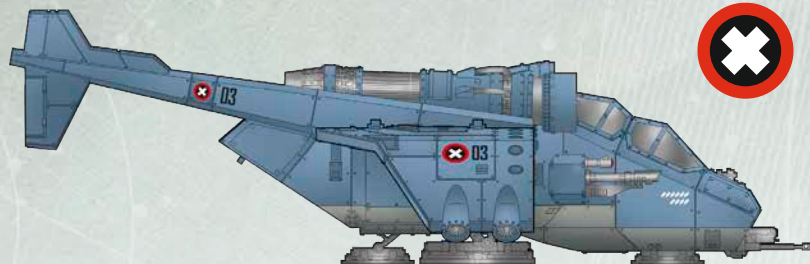

Shield Imperius squadron have now fought alongside the Militarum Tempestus 34th Psian Vipers for over a decade.



Attached to the 34th Betic Centaurs, *Heresy's Foe* has shot down Necron, Ork and Tau fighter craft across a dozen war zones.

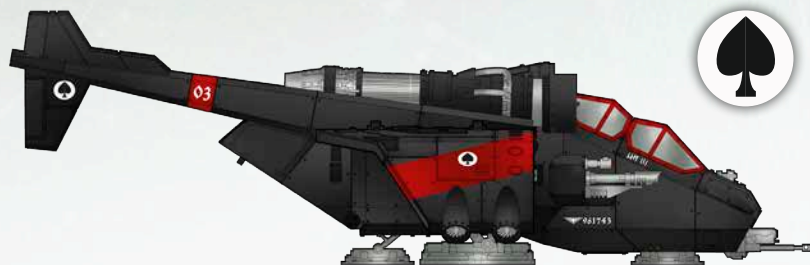

Attached to the 68th Deltic Lions, *Might of Hera* has developed a dark reputation, and is said to have a truly murderous machine spirit.

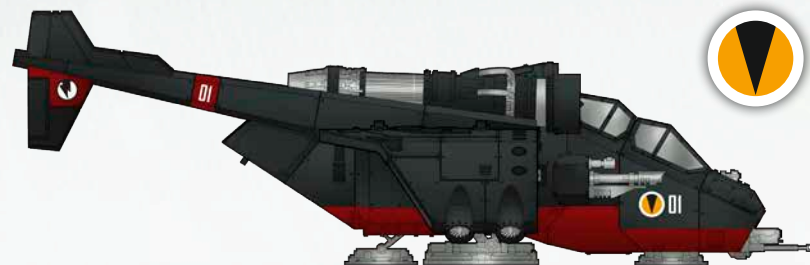

'Redemption' squadron have only recently been seconded to the 29th Zetic Tygers, but have already proven themselves invaluable in aerial interdiction duties.

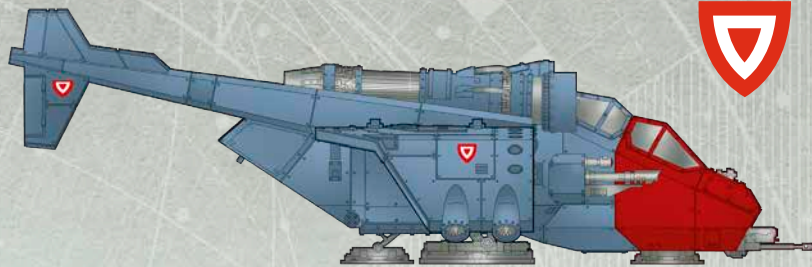

The 43rd lotan Dragons have formally honoured 'Talon' squadron for the exceptional discipline and bravery of its pilots.

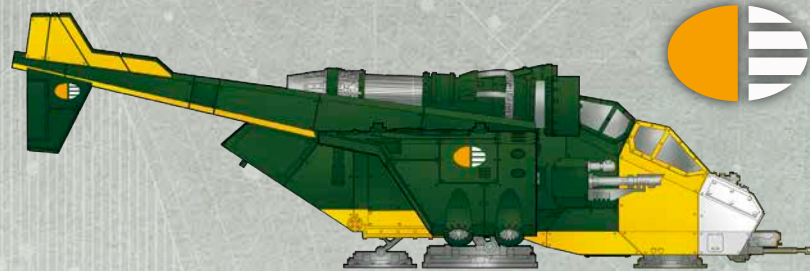

The 73rd Epsilic Eagles prize manoeuvrability to counter fast-moving xenos threats. 'Sunstorm' squadron excel in providing that, alongside heavy firepower.

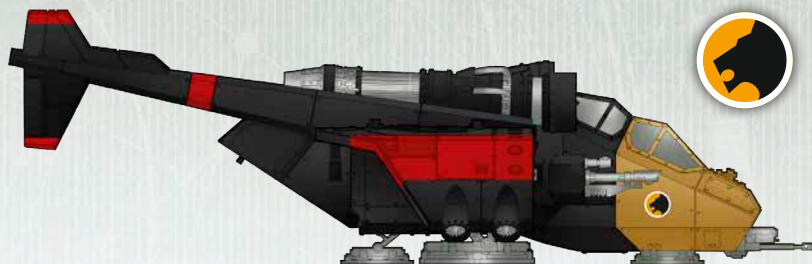

Raven Divinitus is piloted for the 88th Alphic Lions by flight lieutenant Rimnair, who shot down the infamous Grey Ghost in single combat.

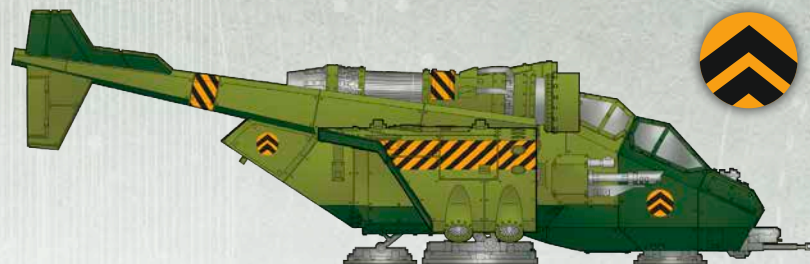

Faith Unquestioning is attached to the 9th lotan Gorgonnes, and is renowned for knocking out enemy bombers before they can strike the Scions on the ground.

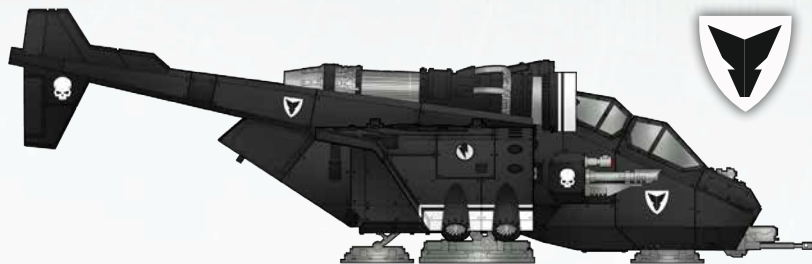

The Valkyrie *Deathshead* acts as the personal transport for Commissar Pultis of the 54th Psian Jakals. It has slain many famed heretic pilots.

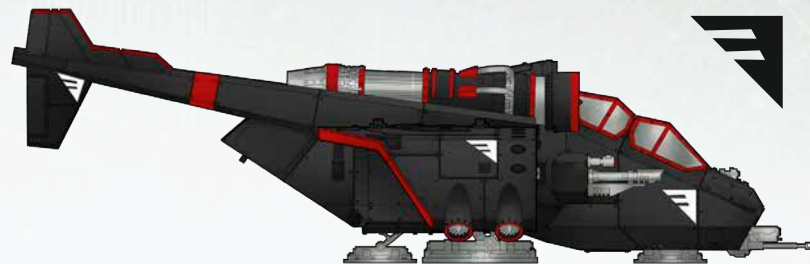

Flying in support of the 22nd Thetoid Gryphonnes, *Steel Shroud* provided transport and covering fire during the assault on Skyrig XI.

DARK ELDAR



Shylair Razorheart is amongst the most infamous Scions of Vileth in Commoragh. Piloting the deadly Razorwing *Lifestealer*, he flies for the Kabal of the Black Heart. Shylair's personal markings are picked out in red on his craft's wings and prow.

The airborne murderess known as the Shroud pilots this Razorwing Jetfighter. Her personal heraldic markings can be seen around the edge of her canopy, while the Kabal of the Black Heart emblem is displayed on the craft's wing and tail.

Following the savage dogfights during the slave raid on Colchiran, Malus Vitrael left his craft bearing the scars of several weapon impacts as a demonstration of his invincibility in battle. His personal rune is a flaming skull upon a green background.



Each winding, flame-orange rune displayed beside the cockpit of the *Eviscerating Kiss* indicates a Craftworld Eldar Ace shot down as the result of a sudden, cruel betrayal. Its pilot, Vandeir Xyl, is proud of his duplicity.

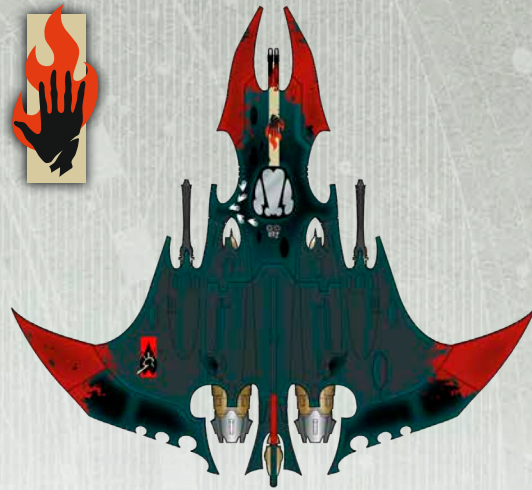

Asdrubael Vect secured the services of the famed Yvris Suddenblade following her vicious excellence at the battle of Taudris. This cruel pilot enjoys dipping low over the battlefield and allowing the sharpened edges of her craft to slice enemy warriors apart.



The frantic kill tallies scrawled across the nose of *Shardghost* are a symptom of its pilot's murderous madness. It is said that this nameless individual has never been quite the same after Vect punished him for some previous failing.



This Voidraven Bomber, *Insidious Shadow*, flies for the Kabal of the Black Heart, hanging above them like a shade.

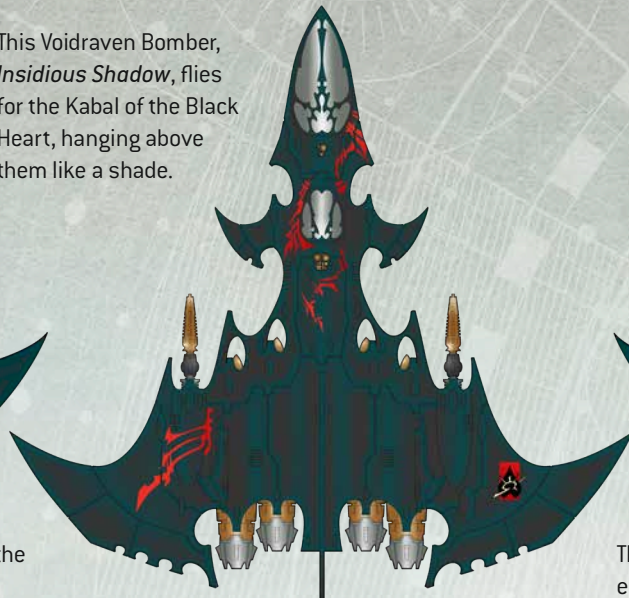
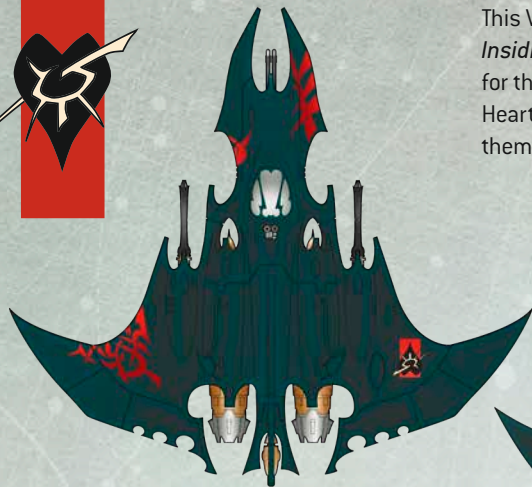

Cruelty Exquisite, a Razorwing Jetfighter flying in the service of the Kabal of the Black Heart

This Razorwing squadron leader's status is shown by elaborate markings on the wings and nose.



This Voidraven Bomber flew for the Kabal of the Flayed Skull during the Whispertheft Raid and slew several Aces.

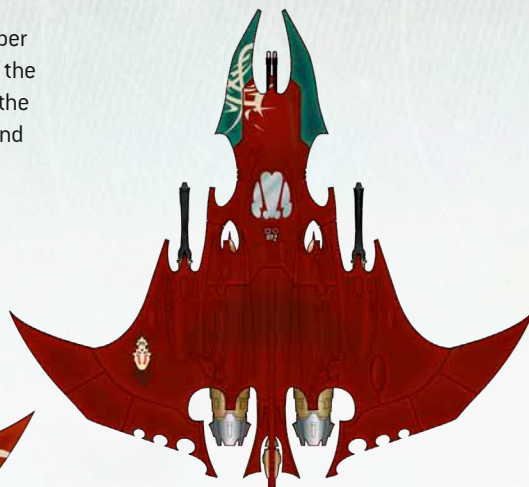
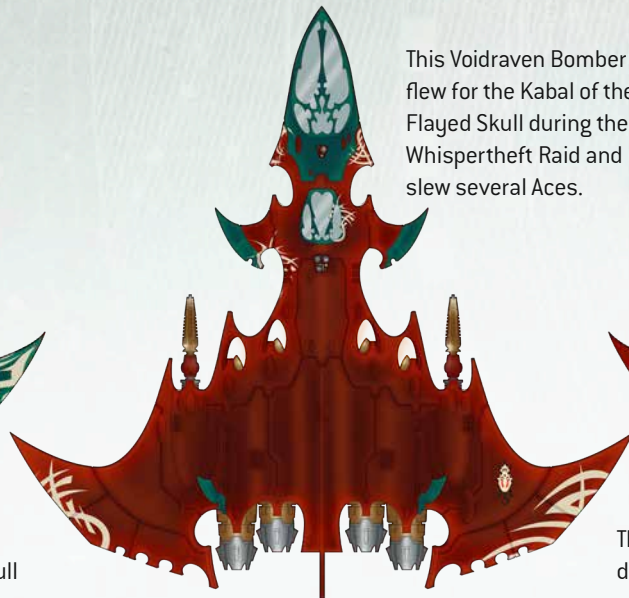

Eyeslitter, the lead craft in a Razorwing squadron who bear the colours of the Kabal of the Flayed Skull

The icon of the Kabal of the Flayed Skull can be seen displayed upon this craft's wing.



Voidraven Bomber *Spirit of Misery*, which shot down three Mordian troop transports over the ironseas of Ghorvex

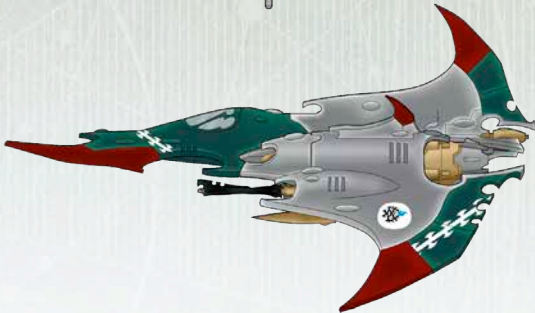

Malice Redolent, a Razorwing in service of the Kabal of the Iron Thorn. It's pilot, Vedrix Khysul, is renowned for running the Fanged Trench on Sundarken.

Malicia Hesperion pilots the *Silent Murder* for the Kabal of the Iron Thorn, and is well rewarded for her martial excellence and cruelty.



This Razorwing Jetfighter bears the livery of the Kabal of the Obsidian Rose, along with bone-coloured patterns proclaiming the pilot's many kills.

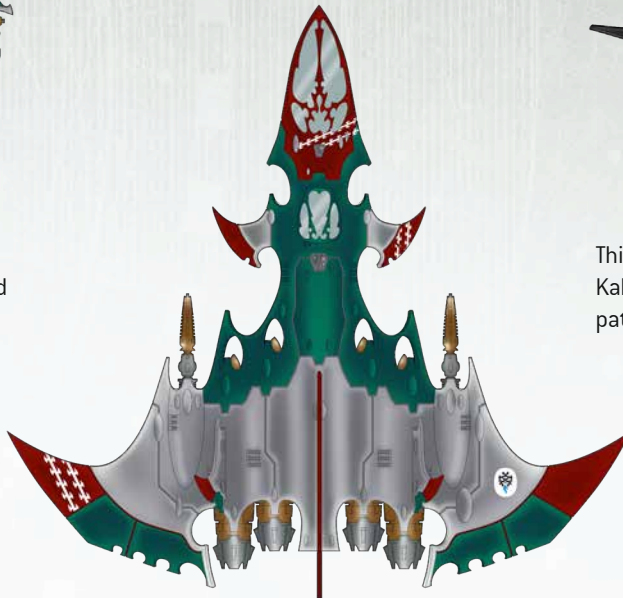

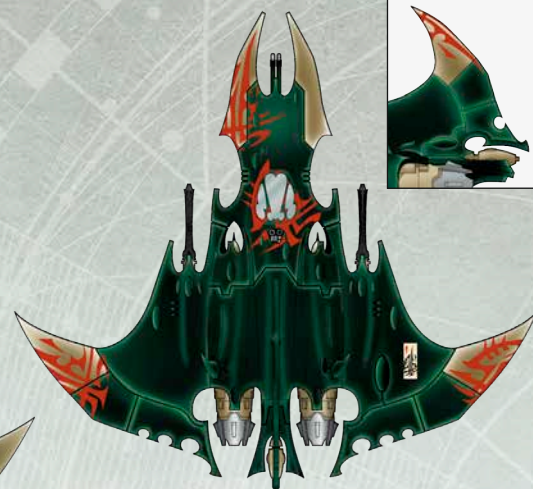
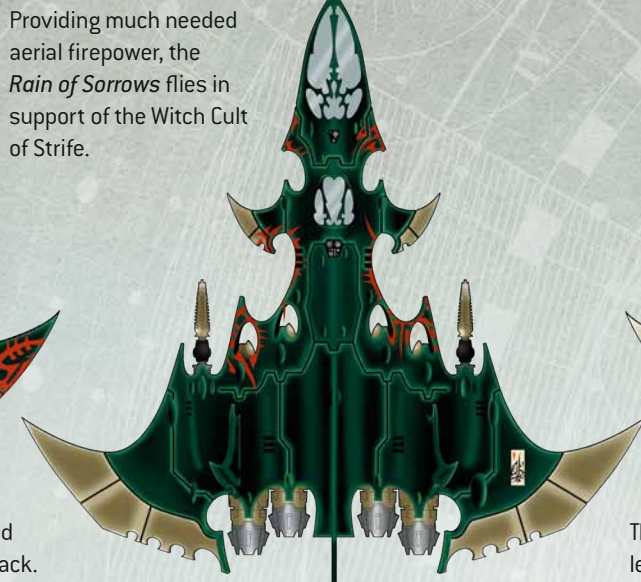
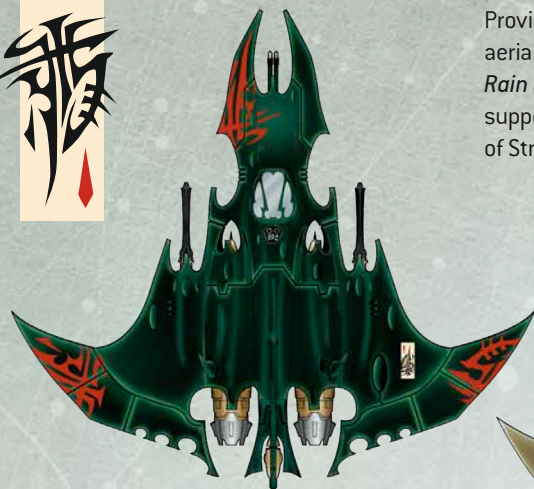

Providing much needed aerial firepower, the *Rain of Sorrows* flies in support of the Witch Cult of Strife.

During the Ythilor Ruse, *Scythe* slew the respected Techmarine pilot Danoss with a cruel surprise attack.

This Cult of Strife Razorwing is marked as squadron leader on its wingtips and nose.

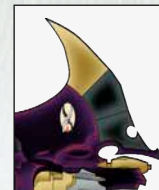
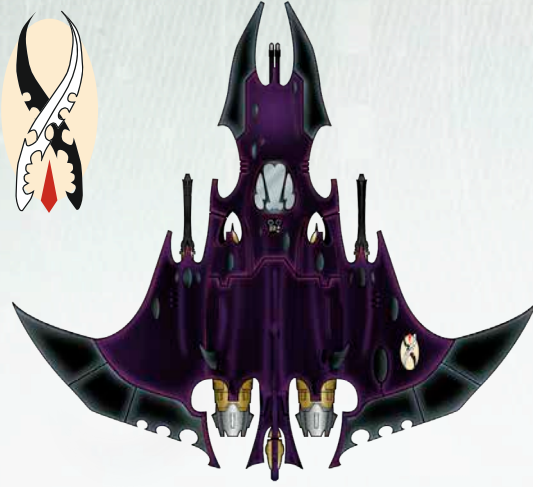

Many foes of the Kabal of the Poisoned Tongue have fallen to the Razorwing *Foul Caress*.

Stinglash Squadron has flown for the Cult of the Blade Denied on several raids into realspace, and perpetrated the now infamous Bloodspire Massacre in the skies over Dolmen Secundus.

KILL MARKINGS



Many Dark Eldar pilots brag of their numerous spectacular kills using markings around their cockpit to represent notable targets slain.

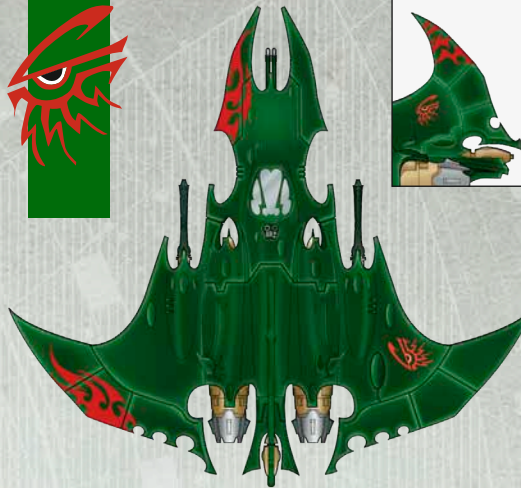

The flamelike designs on the hull of *Bladehag* mock the fiery deaths of its many victims.



Solar Ghost, a Razorwing that flies in the colours of the Kabal of the Broken Sigil

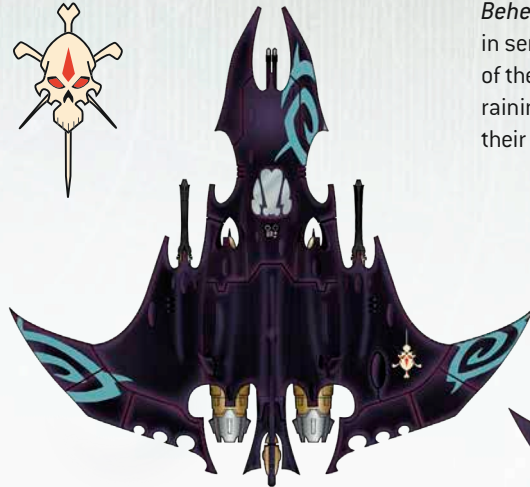

This craft, *Spineflenser*, is piloted by the feared sadist Naerak Heartsbane, the Terror of Tertimanus.

Beheading Blow flies in service of the Kabal of the Last Hatred, raining destruction upon their foes.



This sinister craft flies for the Haemonculus Coven known as the Prophets of Flesh.





