

**FIRST REVISED EDITION
PRIME ONE TIMELINE
[GRAHAM/MANDEL]**

2

**FEDERATION
SPACEFLIGHT
CHRONOLOGY**

TERRAN ORIENTATION

TERRANGOLO LANGUAGE EDITION



**AUTHORIZED
PERSONNEL ONLY**
SECURITY LEVEL TWO

Original texts and manuscript concept copyright © 2007 by Richard E. Mandel

STAR TREK, its on-screen derivatives, and all associated materials are the property of Paramount Pictures Corporation. Multiple references in this document are given under the terms of fair use with regard to international copyright and trademark law. This is a scholarly reference work intended to explain the background and historical aspects of *STAR TREK* and its spacecraft technology and is not sponsored, approved, or authorized by Paramount Pictures and its affiliated licensees.

All visual materials included herein is protected by either implied or statutory copyright and are reproduced either with the permission of the copyright holder or under the terms of fair use as defined under current international copyright law.

All visual materials used in this work without clearance were obtained from public sources through public means and were believed to be in the public domain or available for inclusion via the fair use doctrine at the time of printing.

Cover art by Neale Davidson

This work is dedicated to Geoffery Mandel, who started it for all of us.

Memory Alpha and SFHQ/Mastercom cataloging data:
UFP/SFD DTA HR:217622

21st CENTURY

The Star Age (2001-2100)

PART TWO

2001-2025: BREAKING THE BONDS OF SOL OVERVIEW

TIMELINE OF EVENTS

SPACESHIPS

SPACE FERRY II
STELLAR SERIES SPACE PROBE
AVENTEUR CLASS EXPLORER
BUSSARD RAMJET COLONIZATION SHIP
DY-300 CLASS PROTOTYPE
CYCLOPS CLASS EXPLORER
DY-500 WHEELER CLASS
DY-245 CLASS

ALIEN ENCOUNTERS

FINDINGS OF THE EARTH-SATURN PROBE
EVIDENCE OF LIFE FOUND ON MARS
NAUTILUS LOST WITH ALL HANDS
THE PHOBOS INCIDENT

TERRAN EXPLORATIONS

MARS (SOL IV)

HISTORICAL ARTICLES

THE UNITED SPACE INITIATIVE
FIRST DEATH ON LUNA
THE FIRST SPACE CHILD
FIRST CITY IN SPACE
MARS BASE ONE BEGINS OPERATIONS
EPIDEMIC BREAKS OUT ON MARS
THE SPACE HOMESTEAD ACT
DISCOVERY OF NATURAL ANTIMATTER
ELINORM FLIES AGAIN
"SPINNER" DRIVE DEVELOPED
DISCOVERY OF THE SUBSPACE DIMENSION
UES COURAGEOUS LOST
VENUS TRANSFORMED?
PROBES TO PROBE RED SPOT

SCHEMATICS

ACKNOWLEDGEMENTS



The planet Venus (Sol II)



L-5 Tsilovskygrad at night, c.2020

2001-2025: Breaking the Bonds of Sol



With the dawn of a new millennia in Terran reckoning mankind found himself no longer limited to a single world. He had both the desire and the technology to break the bonds of his homeworld and venture forth into the void. That he did, establishing his first permanent off-world colonies in the Sol System. The first beachheads had already been established on Luna and Mars only a few years before. Within the quarter-century both of these had grown into full-fledged, self-sufficient colonies. New footholds would be established in the inner asteroid belt as well as the Jovian and Saturnian moons. The giant L-4 and L-5 space cities were built in orbit around Terra, with additional ones planned for Mars and other colonized worlds. Mankind even dared to plan for exploration beyond the bounds of his own solar system. This period is known in Terran history as the Planet Age: the period of time in which mankind was no longer limited to just one world for his habitations. It was but the beginning.

Along with this drive into space came a wave of industrialization and technology to support it. Major spaceyards were built both in Terran and at Mars for the building of a new generation of Terran spacecraft. These would finally allow humanity to break the bonds of his star Sol and venture into great Sea of Stars. In the meantime, though, there was plenty enough

exploration and colonization with the Sol System to go around.

With any wave of colonization comes the commoner in time, seeking new fortunes or simply to start anew. The First Great Space Rush began in 2014 with the passage of the Space Homestead Act and would continue for some three decades thereafter. Its generous settlement policies opened the door for the average human to take his or her family, pull up stakes, and resettle off world. In this he was only following the examples of his ancestors: the great Oklahoma Land Rush, the California and Alaskan Gold Rushes, the settlement of the Australian Outback, the German colonization of South Africa, and so on. There are countless parallels in human history. It is one of the idiosyncrasies of humanity: to venture forth against all reason and judgment into an untamed wilderness in order to better one's self and family. So it was then and so it was now. A veritable wave of humans sallied forth into the asteroid belt seeing quick riches through raw mineral mining. Along the way, they ensured that humanity would no longer be a Terra-centric species. Mankind was in space to stay.

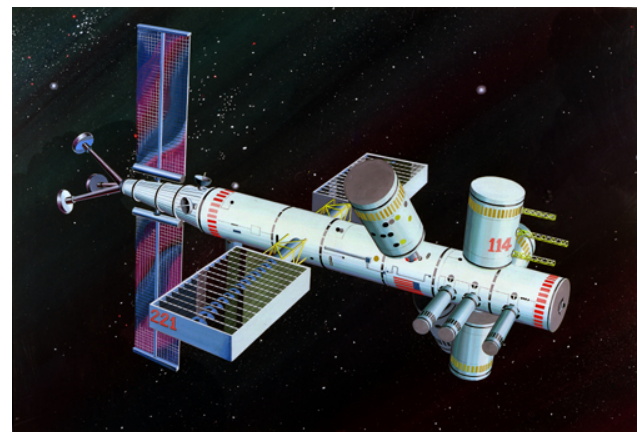

Even with all of the incredible advances that had put mankind into space in so short a time a common consensus was lacking. The Eugenics Wars reminded everyone on Terra what a few well-armed madmen

could do to the planet. If humanity was to survive it needed to get its act together and head for the stars before it destroyed itself in another war. The dawn of a new millennium saw Terra's first one-world government in the form of the New United Nations. One of the first acts it passed was the United Space Initiative, confirming to all that man's ultimate destiny was in the stars. UESPA was reorganized and, as part of this, the United Earth Solar Fleet (UESF) was born. This organization was independent of any Terran nation, using its growing off-world resources to further space exploration efforts. In time it would also take over police and military duties for Terra's off-world colonies. It was the forerunner of Star Fleet.

Around the same time that the UESF was founded UESPA found it needed a better means of coordinating the science and survey missions of Terra's various spacefaring nations. UESPA itself had become too bureaucratic by this point to continue in this task. Instead it created the International Space Agency (ISA) to act as both liaison and coordinator among the various national space agencies. Unlike the UESF, the missions of the ISA were always of purely scientific nature, even though the UESF was sometimes involved in support. The ISA can rightly be said be the Terran forerunner of the organization we know today as the Federation Bureau of Sciences.

Perhaps the most portentous discovery in this period of Terran history was the confirmation of non-Terran intelligent life in the universe. Firm evidence had already been discovered at the end of the 20th century, when the astronauts of Apollo 18 stumbled across a Slaver stasis box on the moon. The million-year-old flying belt found inside, still fully functional, gave Terra advanced anti-gravity technology long before it would have developed it on its own. There were also the striking images of the face on Mars first photographed on the Sidonia plain by the Viking space probe. Further follow-up missions, including a secret side excursion by the Mars Probe One mission, confirmed that the remains of a once-vibrant alien civilization that predated humanity by thousands of years existed on Mars. What the *John Carter*

astronauts found in the Sidonia ruins would be kept a carefully guarded secret for generations. What could not be hid by the New United Nations were subsequent discoveries of fossilized alien life on Mars, as well as evidence of strip mining on the Jovian and Saturnian moons stumbled across by the Saturn-Titan Probe. The cat was now out of the bag, to borrow a Terran euphemism. After the initial predicted culture shock wore off, though, mankind's natural curiosity took over. Humanity might no longer be unique in the universe; however, it was no longer alone, either. A growing desire began to fill the hearts of man to seek out this new life, these new civilizations ... to boldly go where no man had gone before. That desire would eventually take man to the stars and beyond.



As humanity prepared itself to take its first faltering steps beyond the Sol System it knew that its current spacecraft propulsion systems were woefully inadequate to the task. First-generation rockets, powered either by messy chemicals or radioactive fission, were soon replaced by a range of clean and efficient fusion power engines. The technology was perfected and further refined by the end of the decade, resulting in the *ion impulse drive*. This we know today as the impulse engine. Its basic theory and design has remained unchanged ever since this era in Terran spaceflight development. Simply put, it was the most efficient and reliable form of sub-light propulsion ever developed on Terra (or any other Federation world, for that matter). Ion impulse engines would drive two more generations of Terran spacecraft to the stars until the introduction of warp drive in the 2060s.

At the same time that work on the ion impulse engine was proceeding, a spacecraft power plant of a completely different sort was being developed in secret. The details surrounding this remain murky, as most of it was lost during World War III. What is known is that a top secret development program was

initiated by UESPA in co-ordination with NASA (the best of the various national space agencies) and Dyson-Yoyodyne (the pioneers of Terran interplanetary spacecraft). The goal of this program was to develop a next-generation engine for Terra's first interstellar spacecraft, or "starship" for short. What was so unusual about this drive system, if the surviving reports are true, is that it marks the first effort in history of known current galactic humanoid cultures to tap the unlimited power of a controlled singularity. This ambitious project was known as the *spinner drive* and was first tested in small-scale form on a converted DY-200 series spacecraft in 2018. This test just happened to coincide with the tragic loss of the *UES Cyclops*, mankind's first purpose-built starship, which exploded near Mars on its maiden voyage. The cause was never determined; however, many believed it to be due to catastrophic failure of its experimental advanced power planet (the details of which are still unknown. Spinner drive immediately suggested itself as a workable alternative, and efforts commenced on producing a version suitable for driving a starship to Alpha Centauri and back. Those efforts would not see results for another decade.

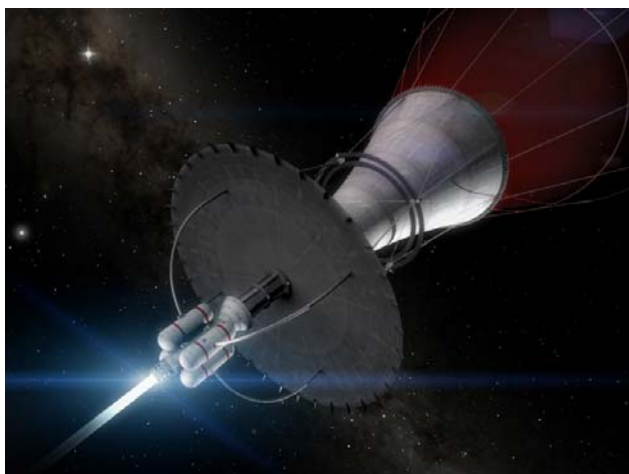

The loss of the *Cyclops* did not mean that mankind's efforts to break the bonds of Sol were at an end. Far from it. As the old Terran adage goes, "If at first you don't succeed, try, try again." A series of privately funded "space arks" had already started leaving the Sol System in 2010, making do with proven Bussard ramjet technology to launch multi-generational colonization efforts at nearby systems. Dyson-Yoyodyne's DY-500 series of spacecraft entered

service in 2019, a year after the *Cyclops* disaster, and become the Terran stellar workhorse of a generation. Its extended range would acclimate crews to being in space for two or three years at a time – excellent training for interstellar missions to come. Also, like its ancestor, the DY-100 class, a member of the DY-500 class would leave the Sol System under tragic circumstances. The loss of the *UES Courageous* would raise the safety bar on all subsequent Terran spacecraft designs, and also lead in due time to humanity's first true successful starship.

One would think that with all of his bounty, the technological rewards reaped from his rapidly expanding space program, and the abundant resources from cheap solar power and asteroid mining, that Terrans would finally shed their clamorous past and unite as one under their new government. Sadly, however, it was not meant to be. A rift began to develop between humanity in space and humanity on Terra. The former were the forward-thinkers, looking ever outward; while the latter were still trapped by the religious and petty bickering of Terra's past. Slowly, inexorably, Terra's space colonies began to distance themselves from the political affairs of their homeworld as Terra began to stumble once again towards the brink of doom. The greed, prejudice, and strident nationalism that should have ended with the Planet Age only seemed to become worse. The age would end with riots around the globe as the socially dispossessed fought for their place in Terra's new society. Events such as the Bell Riots in the United States, the Neo-Trotsky Movement in Russia, a resurgent eugenics movement in Southeast Asia, and the Avingon Riots in France were all signs of a planet falling fast into chaos. Like its two predecessors before the New United Nations proved ineffective in stopping these conflicts. The final straw prove to be the British invasion of the newly reunified Ireland in 2025, done under the pretext of reclaiming its former possession of Northern Ireland. The Planet Age, which had seemed to promise so much for Terra when it began a mere twenty-five years before, ended with the outbreak of World War III.

MAJOR EVENTS

2001

- The New United Nations is established as Terra's first one-world government.
- The Mercury Rover successfully surveys a portion of the hottest planet in the Sol System.
- Terran astronomers detect planets orbiting Alpha Centauri. At least one is believed to be habitable.
- ESA launches its own space station with UESPA approval in order to better service the unique needs of the Common Market.



2002

- The *Nomad* space probe is launched.
- The wreck of the *Yueliang 1* is discovered on the dark side of the moon. It is found by a survey crew scouting locations for the planned Farside Moonbase.



2003

- The first L-5 space colony begins construction.
- The Advanced Comet Probe is launched.
- The United Space Initiative is issued by the New United Nations.
- The United Earth Solar Fleet becomes the formal title of UESPA's space fleet. It is organized along semi-military lines. It is the direct ancestor of Star Fleet.
- UESF's dismal post-war spacecraft inventory, due to losses incurred by the Eugenics Wars, results in a new crash building program.

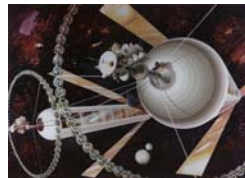

2004

- The first DY-200 *Breton* class ship enters service.
- Goddard Moonbase begins another major period of expansion.
- Farside Moonbase is completed and begins operations.
- The first Terran mass driver begins operations at the Clavius Mines on Luna. This early mass driver is built into the lunar surface. Later versions are more

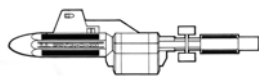

portable and will be common in asteroid mining within three decades.



2005

- Jules Ashworth is the first Terran born off-world. He is born to a scientist working at Luna's Farside Moonbase.
- UESPA initiates its Mars Base colonization program, much to the relief of the early *Martian Genesis* colonists.

2006

- Thomas Morrison is the first Terran civilian to die off-world. He is buried in a simple grave on Luna.



2007

- Tsiolkovskygrad, the first L-5 "space city," is completed and the first 250 residents move in. It is informally nicknamed "New Russia" since the majority of its population consists of Russians and Slavs.

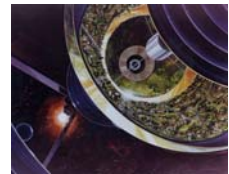

2008

- The tenth and last of the DY-200 *Breton* class spaceships enters service.
- The Fusion Torch, first proposed in the early 1970s, becomes a working reality. It can cut through practically anything, its beam reducing materials to their base atoms. It helps fuel the space industry boom of this era. It also finds immediate applications within the military industrial complex, where it will bring about the development of the Terran particle beam cannon.
- The first Terra-Luna "spacebus" enters service.
- UESPA launches a new series of comet probes.

2009

- New Constantinople, the second L-5 “space city,” is completed and opens its doors. It will become a haven for disaffected Middle Eastern cultures. Five more will be completed every two years, to varying designs, for a grand total of seven parked at the L-4 and L-5 LaGrange points in orbit around Terra.
- Mars Base One is completed on time and on schedule. It is the first of the official Martian Colonies. Many former *Martian Genesis* colonists gladly take up residence, leaving their old colony mostly deserted.

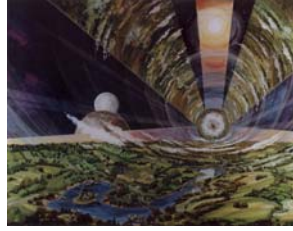

2010

- Five early multigenerational colony ships are launched from earth by private concerns around this time. Among these are the *Forty Families*, the *Marilee*, and the *Alamo*. These projects are not sanctioned by UESPA although they are given launch and intersystem clearance. This effort will help inspire the later Space Ark program.
- The first New United Nations space census is conducted.



2011

- “Martian fever” ravages the Martian Colonies. It is a previously unknown viral strain awakened from hibernation by the terraforming effort on Mars
- The DY-200 *Bretan* class receive their first major in-life service overhaul and upgrade

2012

- Both Goddard and Farside Moonbase set up their own Project SETI divisions by the end of the year.
- Another Project SETI complex is set up on Mars inside the largely abandoned *Martian Genesis*. The only neighbors of the science team are a few “old timers” and a commune of local “space hippies” who have rejected the new, more urban colony lifestyle in favor for the relative isolation of the old colony site.
- Terra’s Orbital Power Satellite Network begins full scale operations.

2013

- The prototype for the new DY-300 class fails its acceptance tests and is promptly abandoned. The planned decommissioning of the DY-100s is put on hold as a result.
- The last of the HLV-type rockets is launched this year. Rocket technology as a whole is largely abandoned as outdated and obsolete, though the basic theory will live on in school science projects and spacecraft steering thruster systems.



2014

- The Space Homestead Act opens the Sol System’s inner asteroid belt for colonization by anyone with the means to get there. This marks the beginning of the first great Space Land Rush.
- An expedition to Jupiter by the DY-100 class spaceship *Savannah* marks the farthest that a manned expedition has yet traveled in the Sol System.
- The Asteroid Rover unmanned surveying probe enters service.

2015

- Mars Base Two is completed.
- The *Stellar* series of interstellar probes enters service.
- The last of the *Lindbergh* class Space Ferry IIs are withdrawn from service.

2016

- The DY-100 class *King Charles* and the newly returned *Savannah* are decommissioned. They will serve as testbeds for the new DY-500 program.



2017

- Discovery of natural antimatter by the UESPA space probe *U Thant*
- Mars Base Three, the third and final part of UESPA's Martian Colonies project, is completed. With this the Martian Colonies are now in theory self-sufficient, although they still gladly welcome visiting supply ships from Terra and other space colonies. The Martian Colonies will become a major hub of trade and commerce among Terra's rapidly growing interplanetary space colonies.
- Dyson-Yoyodyne and several other Terran astronomical engineering firms are granted permission by UESPA to set up factories and shipyards at the Lunar and Martian Colonies. Most large spacecraft construction projects will move to these new facilities over the next two decades once they are completed.



2018

- UESPA tries and fails to launch a manned expedition to Alpha Centauri this year. There will not be another one until a new generation of long-range manned explorer craft is developed.
- The last DY-100 ship in service, the *Werhner von Braun*, is decommissioned.
- Development of the "impulse engine," so named for its fusion-powered, internally metered ion impulse drive. Its main advantage is that it can use practically anything ("even rocks") for fuel. Once perfected, it will become the drive system of choice for future Terran vessels. Even after the invention of warp drive it will remain the most practical means of sublight propulsion for centuries to come.
- The "spinner drive" is successfully tested for the first time on the converted DY-200 *Exeter*. It marks the first Terran spaceship engine design to employ a controlled singularity. The loss of the *Charybdis* in 2038 will be blamed on the failure of such an engine and the program subsequently abandoned.
- " Sleeper ship" technology becomes a thing of the past thanks to the dual developments of impulse and spinner drive.
- The *Aventeur* class spaceships enter service. It is the first manned Terran spacecraft fitted with ion impulse drive.

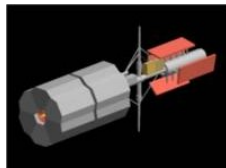

- UESPA organizes the International Space Agency (ISA) as a means for the various Terran national space agencies can coordinate their own space science missions. This allows it to concentrate more on its off-world efforts, such as its new project on Mars.
- The first Terran homesteaders depart for the asteroid belt.



2019

- The DY-500 *Wheeler* class enters service.
- On the 50th anniversary of Apollo 11 the New United Nations declares all seven Apollo landing sites and the crash site of *Yueliang 1* as historic monuments.
- UESPA approves the construction of what will eventually become the Utopia Planitia Shipyards at Mars. It is built and financed by all of Terra's leading space industries, as opposed to a sole corporation.
- The Saturn-Titan Probe is launched under the command of USAF Colonel Shaun Geoffery Christopher.



2020

- The Saturn-Titan Probe arrives at Saturn. Its first real discovery is of alien mining activity in its ring system. Its second is that the moon of Iapetus is the hulk of a giant spaceship.



2021

- The first true non-Terran lifeforms are discovered on Mars. They are the fossilized remains of insects uncovered during a fierce planetary sandstorm.
- The submersible *Nautilus* is crushed by a giant squid while exploring Europa.
- The Phobos Incident. A Martian Colonies mining expedition is lost with all hands on the Martian moon. For the first time in Terran history the security clause of the New United Nations charter (Article III, Section 31) is invoked. UESF forces lock down the Martian moon and refuse to answer any inquiries other than returning the bodies to their next-of-kin.

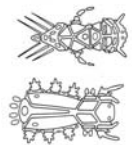

2022

- The subspace dimension is discovered, though as yet there is no means to tap its potential.
- The first of two new DY-300 prototypes is built and begins extensive testing.
- The DY-500 class *Courageous* is lost with all hands, becoming Terra's first interplanetary tragedy.
- The last of the *Stellar* probes is launched.
- Death of Jackson Roykirk, inventor of Nomad.



2023

- A comet is successfully diverted from eventual Terran impact in a few years by installing massive fusion engines and altering its course. It is put in a parking orbit around the Solar System for the time being. In later decades this will become the first Star Base 1.
- A new pair of DY-300 prototypes is built using ion impulse drive engines.

2024

- The Bell Riots; San Francisco dissolves into anarchy
- Ireland is reunified by force, providing the catalyst for World War III.
- UESPA gives final approval for the Venus Terraforming Project.
- The last Terra-Luna spacebus is taken out of service.

2025

- The Jupiter Red Spot Multi-Probe Mission marks ISA's first successful mission as an independent agency.
- UESPA's Venus Terraforming Project begins.
- ISA's *Ares IV* topographical survey mission to Mars is commissioned. The project is expected to last at least a decade. Its goal is to scout and survey a number of surface locales for possible future colony sites.



- Zephram Cochrane, the man who will make faster-than-light travel a practical reality by solving the riddle of the warp drive, is born on Alpha Centauri.



The launch of *Nomad* (2002)

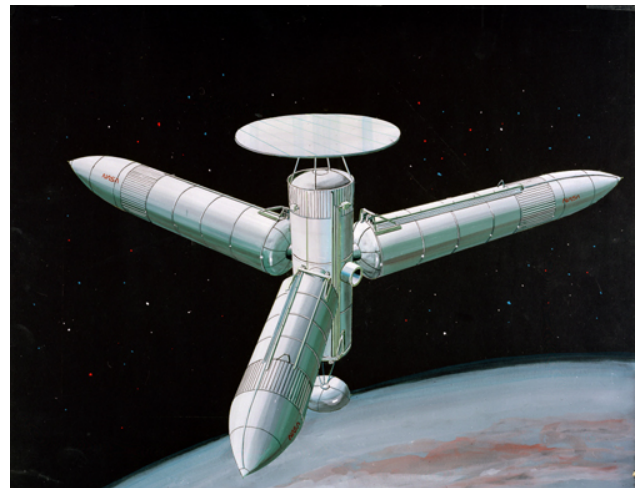

Terran interplanetary refueling station (c.2010)

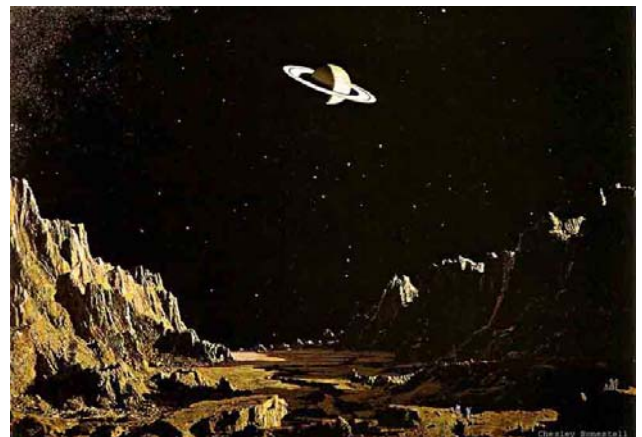

Saturn, as seen from Iapetus

SPACESHIPS

LINDBERGH CLASS SPACE FERRY

SERVICE ENTRY DATE (OLD CALENDAR): 2003

The *Lindbergh* class Space Ferry (or Space Ferry II, as it is sometimes called) was the last in a generation of reusable, chemical-powered Terran orbital spacecraft dating all the way back to the X-20 DynoSaur program in the 1960s. As originally designed it would achieve orbit via chemical boosters; however, the fusion revolution at the turn of the millennia eliminated the need for them. These Space Ferries played a key role in the establishment of the Orbital Power Satellite network that guaranteed Terra's independence from fossil-fueled power stations. It also played a key part in ferrying finished components for the construction of the first L-5 O'Neill "space cities." Though they were only in service for 12 years they had a major impact on Terra's growing space program.

SPECIFICATIONS:

Length: 61 m
Beam: 51 m
Draft: 51 m
Mass:, 2500 DWT
Crew 6
(+ up to 125 passengers depending on configuration)
Range: Terra-Luna and Terra/L-5 runs
Maximum speed: 11,000 m/sec

Innovations/Experiments:

- Could carry up to 10,000 cubic meters of cargo
- Multiple cargo bays (8 per side) for easy access

VISUAL:

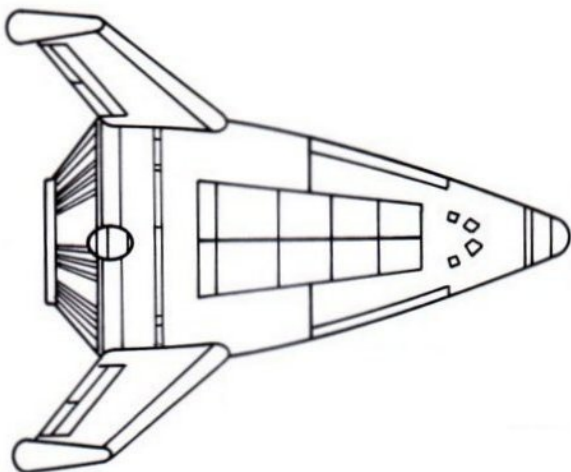

STELLAR SERIES SPACE PROBE

SERVICE ENTRY DATE (OLD CALENDAR): 2015

These were the first Terran space probes that were specifically designed to travel into the void beyond Pluto. Their main purpose was to gather data necessary for the proper construction of Terra's first generation of true interstellar manned spacecraft. Recent advances in Terran computer technology made these Terra's first space vehicles of any kind equipped with a form of artificial intelligence (AI). They also carried an advanced fusion drive system that was the forerunner of the ion impulse engine.

The *U Thant*, a *Stellar* series probe launched in 2016, was the first Terran spacecraft to discover the existence of natural antimatter, long thought by Terran scientists to be a physical impossibility. This discovery would help pave the way towards the development of human faster-than-light technology.

SPECIFICATIONS:

Length: 85 m
Beam: 44.5 m
Draft: 44.5 m
Mass:, 8000 DWT
Crew none
Range: 5.9 light-years (Barnard's Star)
or 2500 days at maximum fuel consumption
Maximum speed: 0.104c

Innovations/Experiments:

- First Terran space vehicle equipped with an AI

VISUAL:

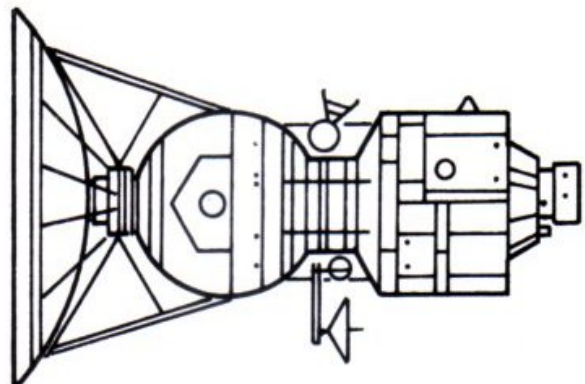

BUSSARD RAMJET COLONIZATION SHIP

SERVICE ENTRY DATE (OLD CALENDAR): 2010

This was the designation given by UESPA to a string of private sub-light colonization ships launched from Terra starting in 2010. Though the designs tended to vary among individual efforts all of them had one thing in common: their massive Bussard ramjet engines. These were a cheap alternative to the normal fusion plants of the day. The basic principle involved fueling their engines with a giant forward scoop (usually a EM field or polarized mesh many times the size of the actual ship) that would scoop up the hydrogen normally present in the interstellar void. This would then be force-fed into the ship's engine in the same manner as a traditional atmospheric ramjet engine. As long as the ship was moving it would essentially fuel itself. UESPA was leery of such a system and never gave these efforts public backing. Instead, the groups backing these craft worked in co-ordination with UESPA's member space agencies, such as NASA and the ESA. All UESPA had to do was approving their final launch clearance and planned extra-system trajectory. UESPA would later employ elements of Bussard ramjet technology in its first generation of faster-than-light starships.

VISUALS:

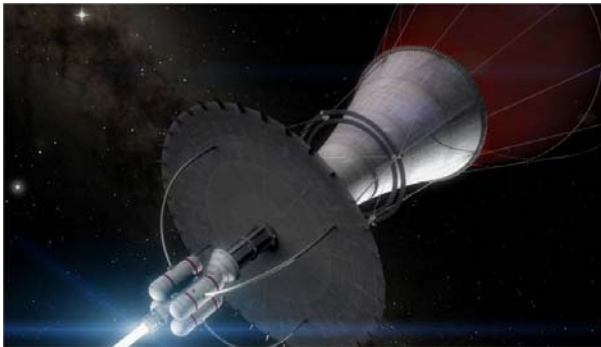

SS Forty Families, the first *Alamo* type spaceship



SS Marilee, a later variant

DY-300 CLASS PROTOTYPE

SERVICE ENTRY DATE (OLD CALENDAR): 2013

The DY-300 class was intended to be the natural successor to the DY-100 and DY-200 classes, and two prototypes were built in 2013 to test the design. Unfortunately, a new structural bracing system employed in construction was found to be seriously deficient and the program put on hold. Both the DY-300 and successor DY-400 class would be delayed until the 2030s due the problems encountered with these first DY-300 prototypes. Instead, the DY-500 class entered production ahead of schedule in their place.

The early DY-300 prototype program did have one positive aspect, however. For the first time in Terran history a reasoning ship's computer, or AI (artificial computer) was a standard feature in a spaceship. It was this AI, nicknamed "SAL" by the first prototype's crew, that warned them of the structural instabilities which almost destroyed their vessel during one of its test runs. Similar systems would become standard in all future Terran spacecraft starting with UESPA's *Aventeur* class explorer craft.

SPECIFICATIONS:

Length:	145 m
Beam:	29 m
Draft:	45 m
Mass:	4.0 DWT
Crew	30
Range:	untested
Cruising speed:	135,000 km/hr

Innovations/Experiments:

- First use of a AI (artificial intelligence) as the primary ship's computer of a Terran vessel.

VISUAL:

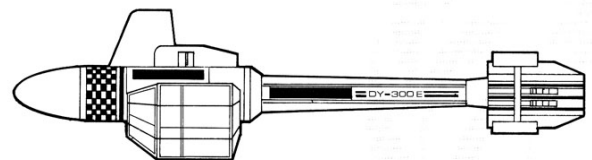

CYCLOPS CLASS EXPLORER

SERVICE ENTRY DATE (OLD CALENDAR): 2018

The *Cyclops* was a one-shot design intended to be mankind's first-ever manned interstellar spacecraft. It was the first product of the TAU Program (Thousand Astronomical Units), thus named for the intended minimum range of such a craft. It was built for NASA under contract to UESPA by Boeing Aerospace. The *Cyclops* launched successfully from Terran orbit in 2018, however, it exploded under mysterious circumstances not long after leaving the vicinity of Mars when it fired its main engine for the first time. All crewmembers were killed and the true cause of the explosion was never determined. This unfortunate incident set UESPA's extra-solar exploration efforts back another full decade.



Not much is known today about the *Cyclops*. All of the development data was apparently lost during World War III. All that is known for sure is that it supposedly employed a "revolutionary" new form of propulsion that was supposedly far in advance of the fusion drives of the day. Most historians have suggested that the *Cyclops* was the first ship equipped with a matter-antimatter conversion drive whose first attempted use went horribly wrong. It may have also been one of the early "spinner" drive prototypes. We may never know for sure.

There would be two more ships of different designs built for NASA under the auspices of the TAU Program. These were the *Cerebus* and the *Charybdis*. Both would prove as ill fated in their time as did the *Cyclops* in its own.

VISUAL:

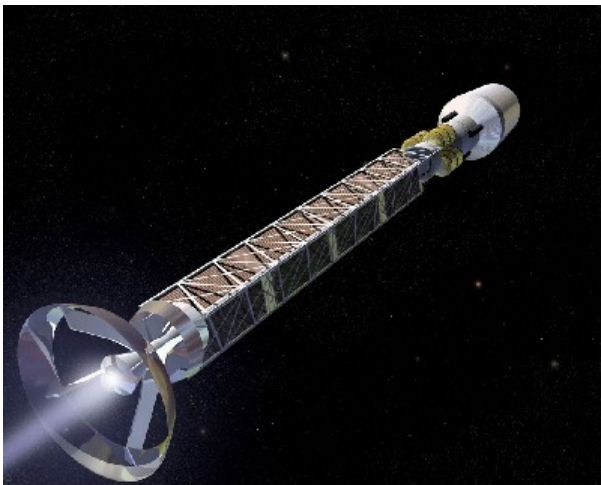

The only known surviving image of the *Cyclops* (digitally enhanced for clarity)

AVENTEUR CLASS EXPLORER

SERVICE ENTRY DATE (OLD CALENDAR): 2018

This was the very first Terran spacecraft design built entirely in space. Construction of the first two vessels was in Earth orbit while the remaining three were built at the new Utopia Planitia orbital complex above Mars. They were all named for famous Terran explorers. They were designed for extended interplanetary survey and exploration across the whole Sol System. As such they had some of the largest cargo capacity and most advanced propulsion systems of their day.

The *Aventeur* class is best remembered for the *Lewis & Clark*, which performed the Saturn-Titan probe of 2019-2021 under the command of Colonel Shaun Geoffery Christopher. It is preserved today at the Utopia Planitia Orbital Museum at Mars.

SPECIFICATIONS:

Length:	125 m
Beam:	28.5 m
Draft:	28.5 m
Mass:	2810 DWT
Crew:	109
Range:	2.57 billion km (Earth-Saturn)
Cruising speed:	700,550 km/hr
Thrust:	135,000 kg per engine

Innovations/Experiments:

- First major Terran spaceship class built with ion impulse drive
- Twelve 1140 cu m jettisonable cargo modules for storage (based on common Dyson-Yoyodyne design)

VISUAL:

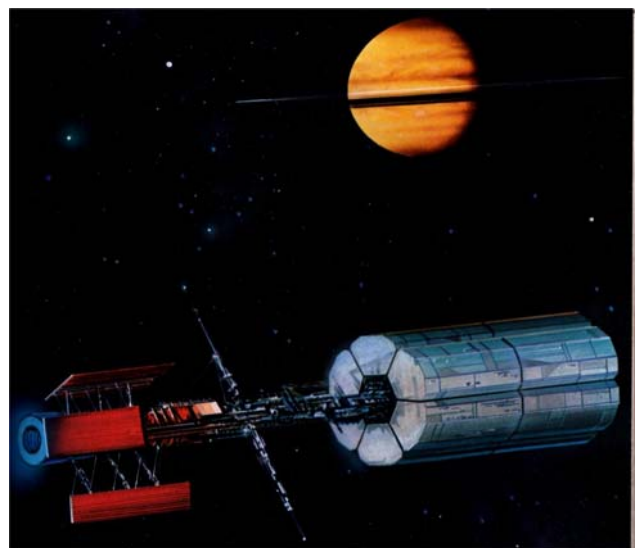

DY-500 WHEELER CLASS

SERVICE ENTRY DATE (OLD CALENDAR): 2019

The DY-500 series was rushed into production ahead of schedule in order to fill the gap caused by the failure of the DY-300 prototypes in testing. In a seeming fit of whimsy the Dyson-Yoyodyne Design Bureau gave every ship in the class names that started with the letter "W" (*Wheeler, Wilson, Woden*, etc.). Company scuttlebutt had it that it was an inside joke and the "W" stood for WAIT, which is what Dyson-Yoyodyne had wanted to do with this class. The real design intended for the DY-500s was incomplete and untested; therefore, a fallback solution was adopted. Vessels in the aging DY-100 class were brought back in and extensively modified to produce the "new" DY-500 class. A new fusion power plant was installed as well as the new magnetohydrodynamic generator (MHD unit). This provided on-board power directly from the thrust from the ship's engines. MHD units were safer than previous systems and this innovation soon became standard in Terran spacecraft of the day. The unused design would eventually become the DY-430 series.

The DY-500 is forever affiliated with the First Great Space Rush. Many were purchased by eager homesteaders for the trip to the Sol System inner asteroid belt. Some of their cargo modules would then be turned into quick-fab homes while the others were used to ship their mined materials back to Mars and Terra. So many DY-500 conversions and new builds happened during the First Great Space Rush that they remained a common sight on the space lanes for centuries. Even today a few of these aging relics can be found in the possession of cash-strapped intersystem prospectors, still slowly plying the spaceways as they did back in their heyday.

SPECIFICATIONS:

Length: 145 m
Beam: 33 m
Draft: 47 m
Mass: 4.2 DWT
Crew 36
Range: 1150 megameters maximum limit
Cruising speed: 135,000 km/hr
Avg. voyage duration: 185 days (Terra-Asterpolis run)

Innovations/Experiments:

- First Terran spacecraft fitted with MHD power units

VISUAL:

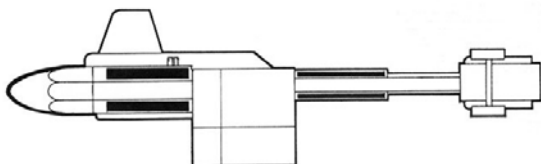

DY-245 CLASS

"STRETCH" TRANSPORT

SERVICE ENTRY DATE (OLD CALENDAR): 2025

The DY-245 class was a stopgap design like the DY-500 intended to cover for the delayed DY-300 program. It was essentially an extended DY-100 with two extra anchor sections for four times as much cargo capacity. It could mount either standard Dyson-Yoyodyne cargo containers or several of the new, smaller "Beach Ball" series in their place for bulk transport of liquids. The design benefited from the advanced power plant of the DY-200 series; however, it was the slowest Dyson-Yoyodyne design in operation (when fully loaded) because of its heavier mass. Even so the DY-245 would become a common low-cost alternative to the *Galileo* transport, shuttling high-volume cargoes on the Terra-Mars and Mars-Asterpolis runs. Many would wind up as impromptu colony ships for trips to the Ficus Sector once that was opened for exploration.



As built the DY-245 series was not given a class name. Most of the vessels were named, if at all, according to the whims of their owners. This practice would be followed with subsequent Dyson-Yoyodyne spacecraft classes

SPECIFICATIONS:

Length: 195 m
Beam: 35 m
Draft: 50 m
Mass: 5250 DWT
Crew 35
Range: 1.15 billion km at maximum endurance
Cruising speed: 135,000 km/hr

Innovations/Experiments:

- First of the DY series to carry the "Beach Ball" bulk liquids cargo container.

VISUAL:



ALIEN ENCOUNTERS

FINDINGS OF THE EARTH-SATURN PROBE

EXCERPTED FROM *AWAKENING* BY RETIRED MAJOR GENERAL
SHAUN GEOFFERY CHRISTOPHER, FORMER UESF CHIEF OF STAFF

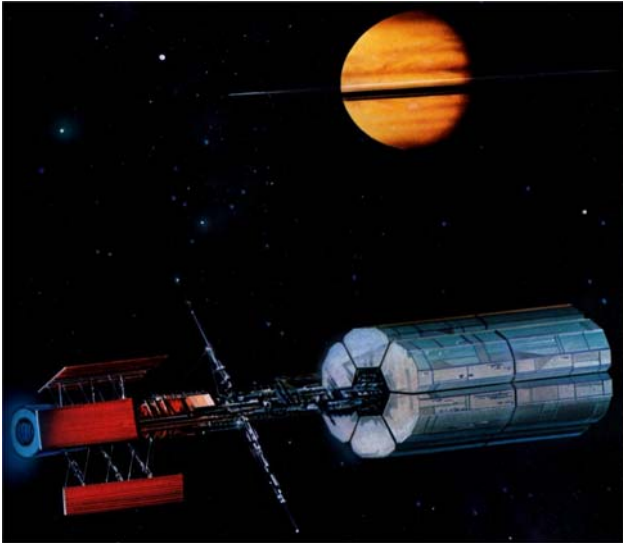

We were conducting a survey of a large moonlet on the edge of Saturn's fourth radian ring when it happened. Lt. Jack Hawkins, the leader of the asteroid survey team I had sent out two days before, called in during what we thought was going to be a routine press briefing.

L & C (Chrstphr): That's all we have to report today, I'm afraid. Frankly I'm surprised any of you guys are still hangin—

Survey (Hawkins): Clark, do you read, over?

L & C (Chrstphr): Sounds like the survey team's calling in. Just a moment. (pause). Survey One, this is Clark, over.

Survey (Hawkins): Colonel?! You won't believe what we just found!

L & C (Chrstphr): (aside to camera) This had better be good. (to console). Go ahead, Survey, we read you.

Survey (Hawkins): Sir! We found machined tunnels! Four of them! Perfectly cut, going a half-mile into this rock!

L & C (Chrstphr): Did you say "machined," Survey?

Survey (Hawkins): Straight line, perfectly smooth walls, almost perfect diameter. Looks like it was done with a fusion torch or something like it.

L & C (Chrstphr): Switch to a secured channel, Survey.

(video goes black)

If I had been following normal UESF protocol the whole transmission would have been secured in the first place and no one would have ever learned about what we found. Perhaps fate had a hand in moving UESPA to schedule daily open press briefings once we got to Saturn. It was only by virtue of the attentiveness of the reporters on line that day that our discovery wasn't hidden from the rest of mankind.

After I got Hawkins calmed down I had him report to me in detail what he and his survey team had found. His report was so astounding that I pulled an EVA as soon as I could to see the site for myself. It was a small, mineral rich moonlet about a three-quarter's hour cruise from the *Lewis & Clark's* geosynchronous position. Once I landed I got to see the shafts for myself.

I remember as a kid when my dad used to take me to Hawaii. Mauna Kea was always one of our stops. I still remember the smoking stones, the lava fields, and in particular the lava tubes. These reminded me a lot of those, save for two important points. One, they were a lot bigger than an ordinary lava tube. Two, they were perfectly straight and round, exactly eight meters in diameter and ending about a half-mile inside the moonlet, where it was obvious that somebody or someone had been mining a long time ago. Whoever it was had cored that moonlet like you would core an apple. We took readings, pictures, videos, soil samples – the works. I knew both NASA and UESPA would be all over this data once we got back. What I didn't know was how soon that would be.

When I and my men got back to the *Lewis & Clark* and checked back in with Mission Control we found that all hell had broken loose in our absence. The reporters who had been present at my interrupted conference had done a full story on the find. The Enterprise Mission was practically beating down UESPA's door demanding to know what was happening on the mission. Even U.S. and New UN officials had gotten involved, demanding reasons as to why the feed had been cut and if a cover-up was being attempted. I have no doubt that a suitable cover-up would have taken place had not my accidental indiscretion prevented such a move. Instead, UESPA was under orders by the New UN for full disclosure, regardless of whatever we found. All future mission reports would be beamed "live" back home for anyone

who wanted to follow them. Those who might have wanted to suppress our discovery for reasons of their own would never get the chance.

We found the ruins three days later on another moonlet rich in organic salts. Together, I and my men walked down ways and among places when no man had ever set foot before. What we saw were ruins everywhere, obviously the work of intelligent and guided hands. They looked like the pictures from Sidonia that we were sent by Graham Harper's team at the Enterprise Mission. A few small collapsed pyramids, worn by the solar winds and local forces, but mostly ruined buildings and strip mining scars. Our initial analysis coupled with data from UESPA suggested that it might have been a base camp for mining activities in the area. I remember feeling humble for the first time in a way I've never felt before as I walked among those ruins. They were here first, I told myself – the Builders, as I called them – the culture that had created this incredible place. They came, took what they needed, and left, with no trace as to who or what they were.

We were given an extra day to swing by Iapetus before returning home. UESPA wanted us to send an EVA down to its surface for a quick look before our supplies ran short. Based on what we had found and additional data from the Enterprise Mission they were certain we would find something at Iapetus. "Whatever," I remember saying on the comm. "This mission's gotten pretty loony already. What's one more Earth-shattering discovery, anyway?" Truth to tell, though, I was pretty excited. I remember reading *2001: A Space Odyssey* by Arthur C. Clarke when I was a kid. The actual book – not watching the movie, which I did later. In the book they found the alien monolith in the exact center of the largest crater on Iapetus. It's so large that you can almost see it from Earth with a powerful enough telescope. Makes the whole moon kinda look like the Death Star from the *Star Wars* movies. I had a hunch, but based on what we had already found it was as good a plan as any.

We went into parking order around Iapetus the following day and I ordered two EVA teams down to the surface. One would examine the odd mountain ridge that wrapped all the way around the moon's equator like a strap band on a boiler. The other, which I lead, headed straight for the center of that crater. I didn't expect to find TMA-2 rising up to greet me out from the crater floor, but I expected to find *something*. I was not disappointed.

No sooner had we dropped within a mile of the surface that we began making out patterned ruins in the crater floor. They extended all the way to the rim of the crater and even partway up the wall. The farther we descended, the more they began to look familiar – and then suddenly I realized what we were looking at. We were dropping into an area where decks had been torn into and opened to the vacuum of space by the long-ago impact of some giant meteor or something. This was no moon. This

was a *spaceship* of massive proportions – or rather, *had* been one. Whatever event had torn this crater into its side had probably killed every Builder on board. Now only the lifeless hulk remained, trapped forever by Saturn's gravity as a dead and lifeless moon.

We spent maybe an hour exploring part of one of the exposed sections on the crater floor. I didn't want my men going too far inside the wreck because we were not properly equipped for such an expedition and our time was limited. I check in with Lt. Dullea and his men up on the mountain range. As I expected, they were finding pretty much the same thing. They even found bits of what appeared to be old computer control systems, or something similar. Both our teams took readings and plenty of samples, then with much regret we returned to the *Lewis & Clark* for the trip home.



My last sight of Iapetus was just after we fired our main engines to break orbit. I looked out the window and saw it sitting there, moon no more, but an incredible artifact to a people and a time that had conquered the stars before we even learned to make fire. The Builders had come here, they had lived and worked here, but despite their incredible technology they had apparently died here as well. What awaited us inside the depths of that ruined alien ship, one that had swung captive in its orbit around Saturn for thousands of years, waiting for the day when mankind would be smart enough to find it and unlock its mysteries? What would we find someday within the ruin of Iapetus?

I prayed that I would be chosen for the follow-up mission.

EVIDENCE OF LIFE DISCOVERED ON MARS

UNITED NEWS SERVICE PRESS RELEASE – 20 APRIL 2021

Scientists working at the Martian Colonies have recently discovered hard evidence of life off of Earth. This marks the first time that real evidence of life not of terrestrial origin has been uncovered. The find was announced by Dr. John Oppenheimer, chief scientist for Mars Base One. Samples of a recent dust storm that swept Mars for three months were undergoing routine study when pattered material of an unmistakable organic nature was detected. Upon closer examination pieces of fossilized insectlike creatures were discovered.

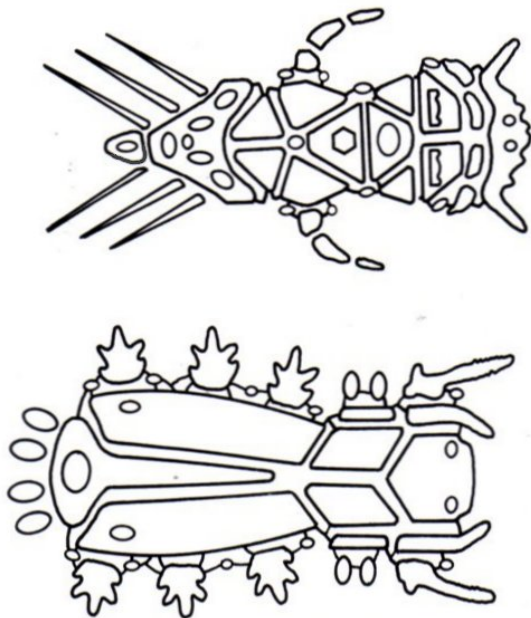
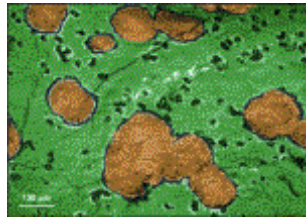

Computer reconstruction indicates at least two different kinds of insects, averaging 3 cm long and 1 cm in width. Initial isotope dating places the age of these fossils at several million years. "It was a completely unexpected find," says Dr. Oppenheimer. "It proves beyond all doubt that life as we know it once existed on Mars." Dr. Oppenheimer went on to say that these creatures appeared to be silicon in nature, completely different than the carbon-based life forms of Earth. He went on to say that the meant that life as we know it represents only one evolutionary path and that many others must certainly exist. "We're just getting started in space," Dr. Oppenheimer said. "This is just one small sample. We really don't have any idea of what kind of life forms we may run into once we start exploring other worlds."

NAUTILUS LOST WITH ALL HANDS

UNITED NEWS SERVICE PRESS RELEASE – 6 OCTOBER 2021

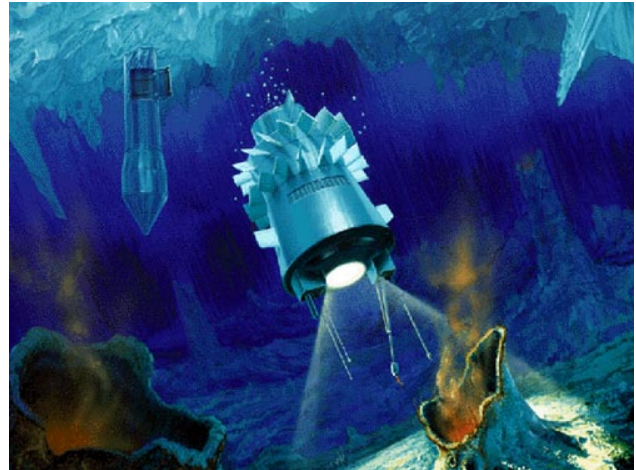

Robotic survey mission of one of Europa's moons (2020)

One of the worst tragedies in space exploration occurred today on Europa, one of Saturn's moons. The science survey submarine *Nautilus* was lost with all hands when it was attacked by a school of 50-meter long giant squid. Europa survey leader Heidi Rasmussen and her team never had a chance to reach the surface. All aboard died when the submarine's hull was breached during the attack. A memorial service will be held as soon as arrangements are made with the respective families.



Deep Flight submersible (2006)
(a similar multi-man design was used by the Europa Mission)

THE PHOBOS INCIDENT

EXCERPTED FROM *PROJECT SCYLLA: A STUDY IN SPACE SECRECY*
BY GRAHAM HARPER (MARS: FLIGHT OF FANCY PRESS, 2040)



UESF Marine dropship returns to Sidonia Base, 2020

When the first settlers from Earth arrived to take up residence in Mars Base One, the first of the Martian Colonies, they were welcomed by the grizzled veterans from the earlier *Martian Genesis* colonization effort. The newcomers eagerly shared their food, treats, and other delights from home for any scrap of news or other information that might help them to better adjust to their new home. It was during one of these early social gatherings between the two groups of colonists that the newcomers learned a strange bit of news. The *Martian Genesis* had not been the first permanent establishment on Mars. Even as they made their final landing approach, the older colonists told them, they had detected UESF activity on the Sidonia plain. When they had tried to make contact the orbital controller in the *Willy Ley* had warned them off. Everybody who was involved in both colonization efforts knew all about the legends surrounding the plain of Sidonia. The fact that the UESF had declared it out of bounds to all civilians made the mystery even more intriguing. Still, eternal mysteries were not going to put food in one's belly. The matter was set aside for the time being while both groups of colonists focused on making Mars Base One their new home. It would lurk like a half-forgotten shadow in the background of the Martian Colonies for another decade, until the disaster on Phobos would stir it from its slumber once again.

In 2020 Governor Sasha Mendez decided to launch a mining expedition to the moon of Phobos. He had the usual reasons for doing this: fame, fortune, prestige, and so on. Early surveys by unmanned probes had suggested that it was rich in certain rare minerals that were going to be needed by the colony in a few years. Easier to go get them from a known location than go prospecting all over the Martian landscape. It would be the first independent action with regards to space by the Martian Colonies. No UESPA looking over his shoulders this time. He wanted his people to do this on their own.

It was not until early 2021, when the plans had been completed and the mission ready to go, that Governor Mendez bothered to inform UESPA. He did this in form of a casual comment made to UESF General Martin Strother, commander of Sidonia Base, whom he was entertaining at dinner that evening. Strother is reported to have taken the news in stride, then smiled. He put down his coffee, looked Mendez in the eye, and said with a chilling tone, "I wouldn't go there if I were you." Mendez was not to be put off. He cheerfully informed General Strother that as he did not have jurisdiction over the Martian Colonies he and his people "... would go anywhere they damn well pleased." At this Strother took another sip from his coffee, nodded in resignation, then excused himself and made ready to go. Just before he walked out the door, though, he had some final words for Governor Mendez. "All right, Sasha, I can't stop you. I've given you fair warning and that's all I can do. I'll be there to pick up the bodies, though. Remember that."

The communications log of the *Willy Ley* shows that the Phobos expedition made a frantic Mayday at 12:02 AM Martian time from their base camp on the surface. The message was garbled and consisted of a desperate plea for help.

May Day! May Day! ... (static) ... hear me?
Something terrib[le] ... (static, strange sounds) ...
My God! Somebody help ... (static, strange sounds)
... (screams) ... (static)

Within minutes of message receipt a full UESF military rescue unit with armed escort was on its way to Phobos. It was as if General Strother had the ships already fueled and on standby. Shortly thereafter a second rescue effort was launched from Mars Base Two of the Martian Colonies. When it attempted to land on Phobos it was ordered by UESF patrol ships to turn back.

This is UESF Marine Division One to Mars Rescue.
Turn around and go back. We have you under our
guns. I say again, turn around and go back. We will
not repeat this warning again.

And that was that. A week later, carefully avoiding the army of reporters that lay in wait for them, a UESF military convoy came up the old colony canal road and left nineteen caskets in front of the Governor's Mansion with strict orders not to open them or face the consequences. Preliminary scans proved futile, as their outer shells proved to be made of a new lead alloy that defied any attempts to penetrate it with sensor probes. The dead were buried amid great ceremony at the colony graveyard a half-click from the old *Martian Genesis*. Governor Mendez resigned his post and left for Earth on the next available shuttle. To the end of his days he would blame himself for whatever it was that happened to his people on that terrible day on Phobos.

TERRAN EXPLORATIONS

MARS (SOL IV)

Mars was known as the Red Planet in early Terran lore due to its distinctive reddish color. This is due to the fact that its atmosphere is saturated with iron oxide. Mars was a harsh world, once teeming with life, but all of it had died to a planetary cataclysm that completely destroyed the former fifth planet in the Sol System. It disintegrated into the inner asteroid belt as almost half the surface of Mars was impacted by meteors of every shape and size. The Valles Marineris was formed around this time. It is the largest canyon on any planet or moon in the Sol System. Also formed around the same time was Olympus Mons, the largest known volcano in the Sol System. Mars remained a lifeless world for tens of thousands of years, with most of its atmosphere gone and what little water remaining frozen at its poles, until the coming of man in the late 20th century. Early manned expeditions such as Mars Probe One and the *Martian Genesis* found the Red Planet to be a harsh world with many secrets of its lost past buried beneath its sands. Not until the founding of the Martian Colonies in 2008 (and the establishment of the UESPA base at Sidonia somewhat earlier) did Mars begin to yield the secrets of its past. Some were pleasant, such as the alien ruins at Sidonia and the prehistoric fossils in the Valeris Mons. Some were not so pleasant, as the new colonists were about to find out.

A long-range project began in 2009 to jump-start the Red Planet's long-stalled ecosystem. This terraforming effort, which would not be completed for two centuries, almost met with disaster right from the start. A previously unknown virus that had remained dormant due the planet's cool temperatures bestirred itself in the presence of the new, warm, thriving human settlements. Martian fever, as it became known, ravaged the Martian Colonies for a year until a cure was finally found. Once the epidemic was over, however, the colonies began to boom once again.

Mars played a key role in Terra's early spacefaring efforts. It was the first true planet to be settled by Terra. Within three generations the four colonies (and one military base) that were established on its surface grew to support a population measuring in the tens of thousands. Even after the construction of Asterpolis (2026) and the UESF Titan Fleet Base (2034) Mars continued to be a key waypoint in Terran space travel. It was also the site of the first off-Terra major spaceyard and spacecraft support complex, which would in time grow to become the largest (if not the most prominent) in the Sol System. Even today the Utopia Planitia Spaceyard competes with the best in the Federation in the building, support, and refurbishing of Star Fleet and other Federation vessels.



SPECIFICATIONS:

Distance from system star	225 million km
Period of revolution (Terran measure)	24.623 hours
Period of orbit (Terran measure)	686.96 days
Mass	7.3447×10^{22} kg
Diameter	6804.9 km
Axial inclination	25.15°
Average surface temperature	-63° C
	(prior to terraforming, now 30°C)

Satellites	2 (Phobos, Demios)
Planetary Richter Scale rating	K
Level of technology	current

Indigenous culture(s)	extinct
	(<i>homo arieian</i>)
Additional culture(s)	human
	(<i>homo terran</i>)

Major surface features:

- Valles Marineris
- Olympus Mons
- Tharses Plain

Places to visit:

- The Carl Sagan Memorial
- The *Martian Genesis* Historical Site
- The Hogan Richman Museum (Sidonia Plain)
- The Ma'adim Vallis Fossil Fields
- The Utopia Planitia Spaceyards Orbital Museum

HISTORICAL ARTICLES

THE UNITED SPACE INITIATIVE

UESPA ARCHIVAL COPY – 15 OCTOBER 2003



We the peoples of the New United Nations, pursuant to our charter obligations to employ international means for the advancement of all peoples, do hereby declare the United Space Initiative. This document calls for joint cooperation of all member nations and their agencies in space exploration as follows:

ARTICLE ONE – RESEARCH

All space research activities shall be coordinated to allow the maximum exchange of ideas and information. This shall include all research:

- a) in orbit around Earth, its moon Luna, or other celestial bodies,
- b) at any research bases established on Luna, or other celestial bodies,
- c) from interplanetary and interstellar probes, and
- d) from all other interstellar research, if and when such activity becomes technologically feasible.

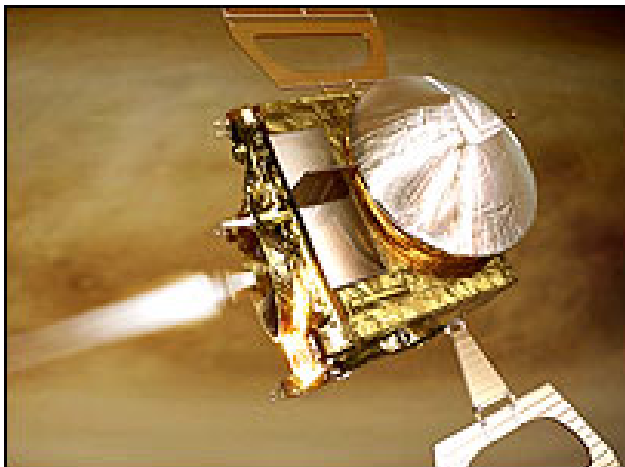

Venus Express probe (2005)

ARTICLE TWO – JOINT SETTLEMENT

- 1) This initiative reaffirms the 1967 Outer Space Treaty of the former United Nations, declaring that space belongs to no terrestrial nation but shall be utilized freely to and for the benefit of all peoples.
- 2) All joint settlements, either in orbit or on the surface of Earth, its moon Luna, or any other planet or location throughout the Solar System shall be declared international zones and fall under the jurisdiction of the New United Nations.
- 3) Local autonomy of settlements peopled by one nation or group shall not be covered by Article 2.2. However, all exchanges among autonomous settlements shall fall under the jurisdiction of the New United Nations.

ARTICLE TWO – EXPLORATION AND SECURITY

- 1) Recognizing the future advisability of interplanetary and interstellar exploration and security, this initiative calls for the establishment of a Solar Fleet, under the jurisdiction of the Space Probe Agency, at such time as it becomes technologically feasible to explore the Solar System and beyond, to maintain the rule of law throughout the planets and to protect against any unknown hostilities.
- 2) This Solar Fleet shall include, but not be limited, to:
 - a) a fleet of ships of a calculated range of classes;
 - b) a Solar Fleet Command,
 - c) multiple Solar Bases for the deployment and servicing of the fleet,
 - d) a monitoring system to insure solar integrity, and
 - e) an academy to be established at a future date to train officers in the specialized fields associated with space security and defense.

* * * * *

IN FAITH WHEREOF the representatives of the governments of the New United Nations have unanimously signed this present UNITED SPACE INITIATIVE,

DONE at the city of New York, the fifteenth day of October, in the third year of the second millennium of the Common Era.

THE FIRST SPACE CHILD

UNITED NEWS SERVICE WIRE – 11 JUNE 2005



Farside Moonbase (2005)

Space child. We've all been familiar with the term ever since the movie *2001: A Space Odyssey* made its mark on humanity decades ago. Today this reporter is pleased to announce the birth of a real space child. Not some supertranscended being or some alien visitor from the stars. Just a simple little boy, born to an unassuming mother at Farside Moonbase only a few hours ago.

Jules Ashworth, named for French science fiction writer Jules Verne, was born to Weldon and Rita Ashworth. Both work in the Astro-Telemetry Section at Farside. Dr. Weldon Ashworth is the director; his wife Rita is his assistant and one of Farside's radio telescope technicians.

Both Farside and Goddard Moonbases have been preparing for the possibility of a birth on the moon for at least a year. The first young married couple, Mikhail and Susa Kourdakov, were granted permission to begin working at Goddard in 2003. The presence of young men and women working in such close quarters under the confined conditions of the moonbases had raised the issue as early as 1998. Both the Kourdakovs and the Ashworths announced their intentions to attempt the conception of a child on the Moon last year with the full approval of all concerned. Rita Ashworth was the first to succeed, with Susa Kourdakov herself becoming pregnant two months later.

The birth of Jules Ashworth is being hailed as the beginning of a new generation of man. Many issues remain head for man's first space child, though. A vigorous medical and physical regimen is being planned so that his body will be able to withstand normal Earth gravity. His bone and muscular structure have formed in a low-gravity environment and he might be injured by Earth's gravity should he ever make the trip. Also, the implications of his growing up in a non-Terran environment are manifold. UESPA is currently reviewing the case of the Ashworths and the Kourdakovs as to whether or not future births will be allowed on Luna.

FIRST DEATH ON LUNA

UNITED NEWS SERVICE WIRE – 15 MARCH 2006

Thomas Morrison of Goddard Moonbase today became the first civilian to die on the Moon. He was killed when his suit ruptured due to a fall at the Clavius Mines. Morrison had been part of a survey team scouting a nearby crater prior to drilling of an exploratory shaft. He apparently lost his footing on the unstable rocks of the canyon rim and fell, tearing his suit in several places. By the time his fellow survey team members came to his rescue he was unconscious from lack of oxygen. Survey team members attempted to rush him back to their rover but their bulky suits and the low lunar gravity hampered their efforts. Morrison died enroute to the Clavius Mines Operations Center.



Thomas Morrison was single. He is survived by one sister, Linda Jackson. His body will be shipped back to his home town of Amarillo, Texas, for burial.



Goddard Moonbase (2006)

FIRST CITY IN SPACE

CNN HEADLINE NEWS – 15 MARCH 2006



Interior of Tsiolkovskygrad (2007)

At this moment I am watching a spectacular sunrise – if that’s what you can call it – caused by the light of the sun hitting one of the giant reflector mirrors of this truly massive space station. It’s called a city in space: five miles long, the interior lined with trees, lakes, rivers, all kept in place by the station’s massive artificial gravity core. Words and pictures fail to accurately convey the magnitude of this accomplishment.

With me today is Tsiolkovskygrad City Supervisor Boris Karpev from the Russian Confederation.

Karpev: Good evening.

Who is this station named for and why was it built?

Karpev: Is named for Konstantin Tsiolovsky, inventor of rocket. Station was built as new home for people away from troubles of Earth. New start, as you say.

And how many want that new start?

Karpev: We have 250 move in today. 1000 more waiting. Others apply. (laugh) Waiting list is quite long.

So, if I wanted to move here, how would I apply?

Karpev: Papers at your local UESPA office; however, you won’t get here right away. (laugh again) Waiting list is quite long.

(reporter laughs) I’d imagine. You’ve built something truly amazing. No wonder everybody’s trying to get here.

Karpev: Thank you.

For CNN Headline News, I’m Roger Spector.

MARS BASE ONE OPENS FOR BUSINESS

UNS PRESS RELEASE – 19 AUGUST 2009



Today in a press conference UESPA announced the completion of Phase One of its Martian Colonization Program. Mars Base One, the first of three major colonies on the Red Planet, has been completed and officially began operations today.

Mars Base One was not the first colony on Mars. The *Martian Genesis* landed in 1990 as man’s first permanent colony on the planet. The ship was designed as both transport and foothold, actually landing on the planet so the first colonists could live inside. These early pioneers got off to a rough start, with the outbreak of the Eugenics Wars limiting resupply runs. It is a true miracle that none of them died during these hard times. The *Martian Genesis* also provided UESPA with a ready-made beachhead from which it could begin construction of Mars Base One.

The first inhabitants of Mars Base One are made up of two groups. The first are those members of the construction and survey teams who have elected to remain on the planet. The second are most of the *Martian Genesis* pioneers. UESPA had always planned for the *Genesis* colonists to be part of the new colony and many eagerly accepted the offer. A few still remain at the old colony, however, either out of sentiment or preferring its relative solitude.

As was the case with the *Martian Genesis*, Mars Base One will serve as the launchpad for two more colonies. Mars Base Two has already begun construction and is expected to be completed by 2018. Initial surveys are already underway for the site of Mars Base Three, the third and final stage in UESPA’s Martian Colonization Program. Together the Martian Colonies will eventually provide living space and supplies for 5,000 potential colonists. More than three times that number have already applied for admission under UESPA’s Road to Mars colonization program.

EPIDEMIC RAVAGES MARS

UNS PRESS RELEASE – 17 MAY 2011

UESPA's ambitious Martian Colonization Program has hit a deadly snag with the outbreak of what many have come to call "Martian fever." Over 70 colonists are now known to be incapacitated and more than 100 more are showing the signs of this previously unknown disease, which has no match with any known disease on Earth. The Martian Colonies are currently under quarantine as UESPA struggles to deal with the situation before it gets out of hand.



Yesterday the supply ship *Nikita Krushchev* was diverted from its normal duties and commandeered for an emergency medical mission to Mars. On board it will carry extra supplies of medicines and antibiotics as well as a carefully chosen team of doctors from all parts of the globe. These volunteers are determined to find the cause and cure for the Martian fever before it decimates the Colonies. The names of all team members are being withheld for now by UESPA at the request of their families.



A lonely Martian surveyor walks the hills (2008)

THE SPACE HOMESTEAD ACT

EXTRACTED FROM *THE SPACE IMMIGRANTS – THE STORY OF THE HOMESTEAD ACT* BY JOHN BUKOR (NEW CHICAGO PRESS, 2214)



To encourage the colonization of space, while assuring its equitable growth and distribution among peoples, the General Assembly hereby passes the SPACE HOMESTEADING ACT OF 2014.

ARTICLE I – DEFINITIONS

1. A Space Homestead shall be defined as any Solar System body whose volume and/or area is up to, but not exceeding, 100 kilometers in diameter and approved for homesteading purposes by the New United Nations Homestead Commission.
2. Rights to such a space shall be contingent upon:
 - a) the fulfillment of five Earth years residency on or within such a volume, and
 - b) the establishment of at least one permanent personal dwelling environment.

ARTICLE II – RIGHTS AND LIMITATIONS

1. A Space Homestead entitles its owner to exclusive rights over all traffic through, and material contained within, its volume and/or area. This specifically includes those parts of the Asteroid Belt approved for homesteading.
2. All homesteaders are entitled to unimpeded access to the Sun.
3. This Homestead Act strictly limits the amount of space a homesteader may claim to the volume and/or areas specified in this Act.

ARTICLE III – HOMESTEADING INCENTIVES

1. Transportation to any sector approved for homesteading purposes shall be provided by the United Earth Solar Fleet, its auxiliaries, or a comparable civilian agency for the homestead and his or her immediate family
2. A low-interest loan, at rates determined by the Homestead Commission, shall be made available to the homesteader, if desired, to finance his or her homesteading effort. The purpose for such a loan may include but is not limited to purchase of passage, purchase of appropriate spacecraft, purchase of homesteading goods, and purchase of supplies.
3. Persons directly involved with the establishment of or work on a Homestead shall be exempt from Terran taxes and other Terran duties on their person for the duration of the time they spend off planet. This Act does not excuse them, however, from any taxes or other duties that may be levied by governments off-planet, such as those on Luna and the Martian Colonies.
4. Any business that contributes to the furtherance of this Act shall receive an appropriate tax incentive as described in Appendix C of this document.



Mars Base Three construction – early stages (2014)

NATURAL ANTIMATTER DISCOVERED

UNS PRESS RELEASE – 26 FEBRUARY 2017



The Crab Nebula

Antimatter, once thought to be a physical impossibility, was discovered by accident yesterday according to UESPA spokesman Misa Hayase. The discovery was made by the UESPA space probe *U Thant*, which is currently on a long range mission beyond the Solar System. The probe was trying to map the full extent of the Oort Cloud, where many say comets are born, when it was damaged by a sudden nearby explosion. Its onboard AI computer automatically stopped the probe in its tracks, then started its self-repair programs while it tried to find the reason for the explosion. The discovery of natural antimatter as the source was as shocking to the space probe's AI as it was to scientists here on Earth. Stellar Series Program Director Jackson Roykirk admits that it was the last thing they expected to find in the interstellar void. "It's not supposed to exist but it does," he said at the UESPA space conference. "Don't ask me to explain it because I can't. I only know what the probe says." A second probe, the *Waldheim*, is being re-routed to confirm the *U Thant's* findings. The discovery has major implications for space travel and the future of manned space flight beyond the Solar System.

ELINOR M FLIES AGAIN

CNN HEADLINE NEWS – 31 MAY 2018

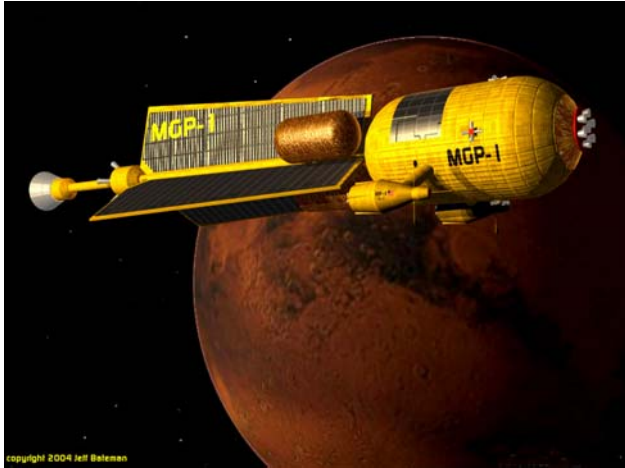

It looks like something from an old science fiction movie. That's because it is. The *Elinor M*, also known as the Mars Gravity Probe and featured in the cult science fiction movie *Robinson Crusoe on Mars*, now flies the Martian skies for real.

John Devolt is a senior mechanical engineer who's been working at the Martian Colonies ever since they were founded in 2009. He is also, in his spare time, a science fiction buff. Devolt got the idea for building his *Elinor M* replica after a special showing of *Robinson Crusoe on Mars* and other movies about the Red Planet during the dedication ceremonies for Mars Base Three.

It's always been one of my favorite movies because it was so well done. It was true to the technology of the day and what they knew about Mars at the time. Then I got to thinking. "Hey, why not build the *Elinor M* for real? We've got the stuff to do it all around us and plenty of time now that the Colonies are finished.

Devolt found backing for his project with the Mars Historical Society, a new organization dedicated to preserving the history of man's relationship with the Red Planet. They recently set up the Carl Sagan Memorial at the landing site of Mars Sojourner and are involved in the efforts to have all of the old Earth space probe landing sites declared historic monuments.

So what's it like to ride in an old spaceship? I took a trip with Devolt in the *Elinor M* for a couple of orbits around the planet. Looking out the window from the capsule, sitting there in my old-fashioned pressure suit, I felt like an astronaut from the early days. This is what it must have been like for them as they braved the stars for the first time. It's a nostalgic trip down history lane for anyone who wants to go. Devolt plans to recreate more historical and fictional Mars ships as tourist attractions once he finds the time to build them.

For CNN Headline News, I'm Roger Spector.

"SPINNER DRIVE" DEVELOPED

UNS NEWS RELEASE – 8 JUNE 2018

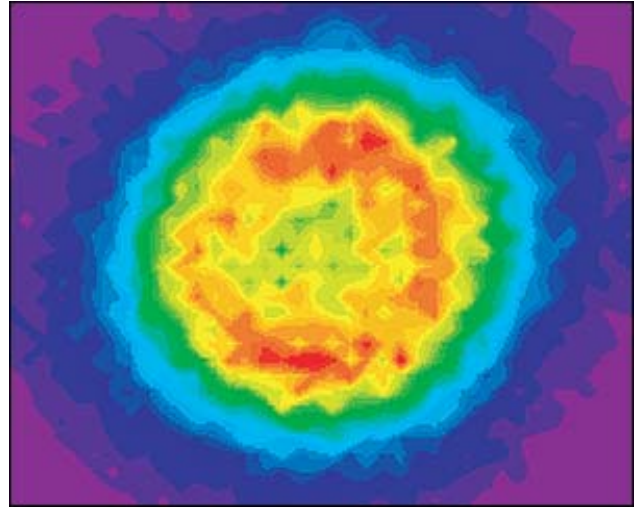

Computer model of a controlled singularity

NOTE: This news release contains several factual inaccuracies. It is included for the sake of brevity and as a starting point for class discussion. For a more accurate depiction of the short-lived Terran "spinner" drive please consult The Revolution That Never Was: The Charybdis and the End of the Spinner Drive by JAT Publications, 2290 (Academy Intranet).

Today Dyson-Yoyodyne announced that its engineers had perfected a new form of space engine that will revolutionize space travel. Called the spinner drive, it works by arranging a series of regular fusion reactors in a ring and firing them all at the same time. The result is what scientist call a controlled singularity, like those featured in science fiction. This produces so much energy that it literally pushes the ship out of its way in order to get out of the ring, propelling it forward many times faster than conventional fusion propulsion. A working model is currently being installed on the *Exeter*, a DY-200 spaceship, as a demonstration for UESPA. The international space agency, fresh with the tragic lost of the *Cyclops* on its mind, is definitely interested in such technology. A number of control and safety issues remain to be resolved before it will approve the use of spinner drives in new spaceships.

NOT SPACE, BUT SUBSPACE

EXCERPTED FROM A TIME MAGAZINE SPECIAL SPACE ISSUE
JULY 2022



The possible existence of other dimensions has long been the fancy of physicists and science fiction writers. Such theories have been given a boost in recent years with the development of the subspace theory. As proposed by physicist Gerald Borkin of the University of Cambridge, subspace is a dimension that is quite different than our own. Most common notions about other dimensions is that they are either parallel to each other or nested one inside the other like a set of Russian nesting dolls. Borkin's theory is that subspace exists perpendicular to our own, not parallel to or inside or around. As such it would have physical properties completely different from those we know.

Borkin's theory has been gaining a lot of ground among space researchers because of what it has to say about the speed of light. In subspace, according to Borkin's mathematical model, the speed of light is not absolute but achievable. All that would be required to push an object faster than the speed of light would be only the energy necessary to put it into subspace. A similar expenditure would in theory allow it to return to normal space. By lowering the total energy cost required, a "starship" could go faster than light simply by enveloping it within a subspace field. The starship itself would not be interacting with our universe, where the speed of light is absolute. Rather, its energy signature would remain while the ship itself would be immersed in subspace like a submarine in the ocean. This is in theory possible because it is a known fact that certain forms of energy, such as Cherenkov radiation and Soliton waves, can travel at faster than light speeds in our universe. The existence of the subspace domain, if confirmed, opens for the first time the possibility for the achievement of theorist Miguel Alcubierre's "warp drive" within the century.

UES COURAGEOUS LOST

CNN HEADLINE NEWS – 2022



UES Courageous, stock photo (2020)

"They're not coming home." That was the tragic message delivered to family and friends of the crew of the spaceship *Courageous* earlier today.

The *Courageous*, a DY-500 class freighter working the L-5/Mars run, roared up from and out of the plane of the Solar System today at top speed, its engines locked at full due to a catastrophic shielding failure. Ship's engineer Haddad Koire and his staff manage to stabilize the fusion drive enough to keep it from exploding. By then, however, the damage was too great to allow them to shut it down. Instead, the *Courageous* will continue to fly away from Earth until its fuel is exhausted and its fusion reactors shut down. By then it will be too far away for any current spacecraft to reach it and rescue its doomed crew.

In his latest contact with UESPA *Courageous* commander Fitzsimmons Wallabee praised Koire's efforts for saving the lives of his crew. "We'd all be dead right now if it wasn't for him," he said. He was painfully honest about what lay ahead for him and his crew. "They've taken the news about as well as could be expected," he said. "Science Officer Boyle says that it won't be long before we hold the intersystem solar speed record. That's something, anyway."

There is no hope of rescue or salvation for this modern *Flying Dutchman*. Their current trajectory is taking them out of the Milky Way without passing within range of any known habitable solar system. Even after their fusion drives burn themselves out and they regain control of their ship they will still be light-years away from any planet or asteroid that might give them some hope of survival.

The *Courageous* is expected to be out of communications range in two days. From then on the fate of that crippled ship and its crew are, to quote an American president, "in the hand of God."

For CNN Headline News, I'm Jayme Lynd.

VENUS TRANSFORMED?

UNS SCIENCE WIRE - 11 NOVEMBER 2024



The original surface of Venus (c.2020)

Imagine living on a planet where the air is almost pure cigarette smoke and the surface temperature is hot enough to melt most commercial plastics. Now imagine that same world as a green, friendly place with a temperate climate, large oceans, and cool breezes. Sounds impossible, doesn't it? That's exactly what UESPA plans to do with Venus, our next-door neighbor in the Solar System.

All plans for colonizing Venus to date have been stymied by the planet's harsh climate and unbreathable atmosphere of carbon dioxide. It has often been described as a "runaway greenhouse effect" and held up as an example of what might happen to Earth someday due to overindustrialization. All of that is about to change, however. Today UESPA gave final approval to an ambitious plan to seed the atmosphere of Venus with millions of blue-green algae bacteria. These thrive on carbon dioxide and produce oxygen in the process. They will saturate the atmosphere of Venus and, over decades, convert its harsh climate into something that humans can stand. Only when that process is well underway will man be able to set foot on Venus. With that, another landmark will be passed in man's quest for space.

PROBES TO PROBE RED SPOT

UNS SCIENCE WIRE – 25 MARCH 2025

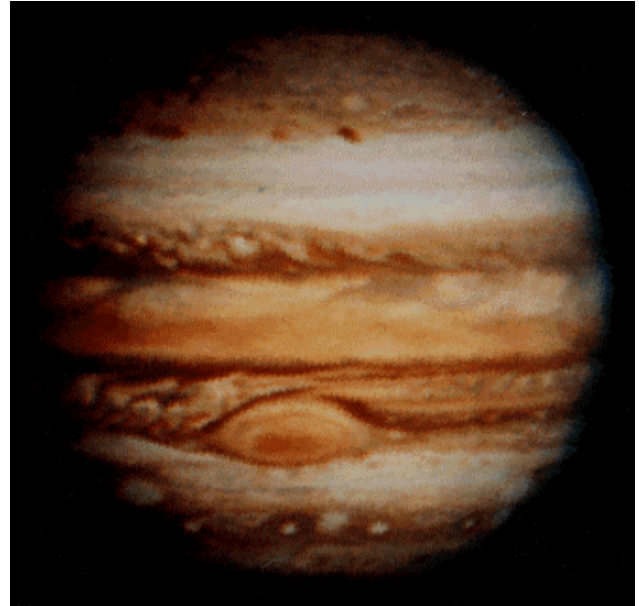

Today a series of twelve probes were launched at Jupiter's Red Spot from the new Ganymede Research Station in an effort to solve the mystery of its existence. The Red Spot has been a fixed feature of Jupiter's surface for 400 years of man's recorded history. The probes were launched from the new Ganymede Research Station under the direction of science supervisor Dr. Lloyd Elkins. "I suspect we'll only confirm what we've suspected all along," Dr. Elkins said when interviewed. "The Red Spot is the closest thing we know to a massive permanent hurricane, caused by electromagnetic emissions from Jupiter's inner core." Dr. Elkins dismisses the possibility of finding any traces of the space probe *Galileo*, which ended its life by plunging into the thick, high-pressure atmosphere of Jupiter. "If we find anything at all it will be in bits and pieces and then only by chance," he said. Dr. Elkins expects to begin getting results from the new Jupiter probes by morning.

SCHEMATICS

VOLUMES 01 AND 02 (NOT TO SCALE)

SPUTNIK 1 **(1957)**

Length: 57.9 cm
Mass: 73.6 kg
Armament: none
Drive: chemical
Range: orbital
Crew: none

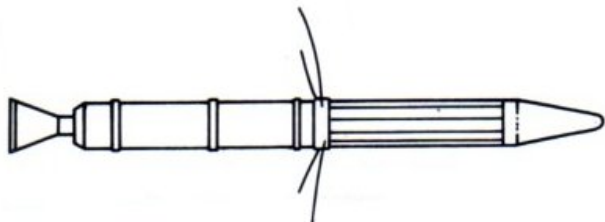

EXPLORER 1 **(1958)**

Length: 203.2 cm
Mass: 14 kg
Armament: none
Drive: chemical
Range: orbital
Crew: none

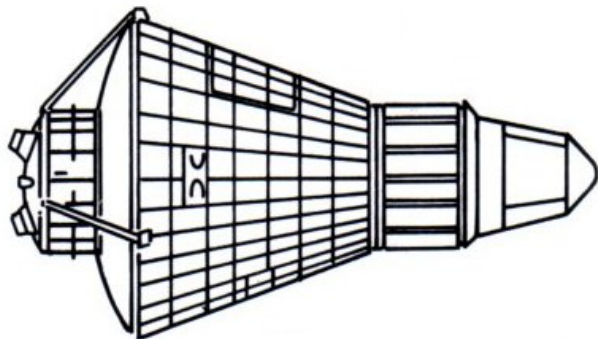

PROJECT MERCURY **(1961)**

Length: 3.4 m
Mass: 1.5 DWT
Armament: none
Drive: chemical
Range: orbital
Crew: 1

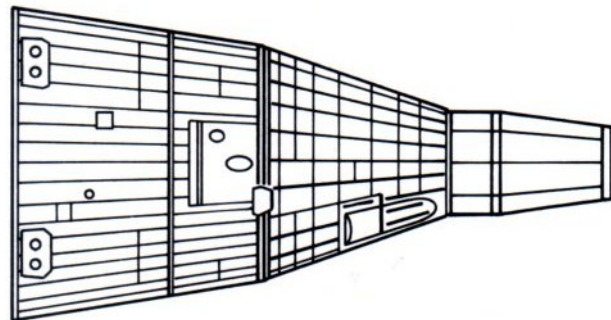

PROJECT GEMINI **(1965)**

Length: 5.6 m
Mass: 4.2 DWT
Armament: none
Drive: chemical
Range: orbital
Crew: 2

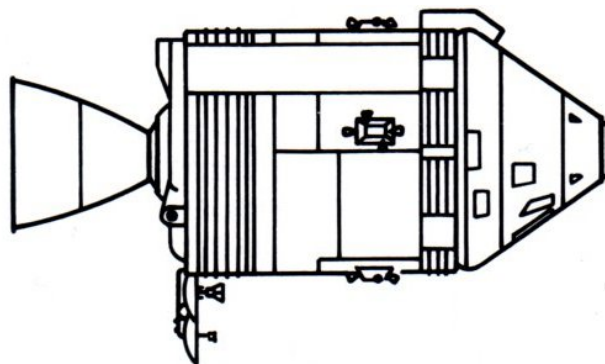

PROJECT APOLLO **(1968)**

Length: 11 m
Mass: 13.3 DWT
Armament: none
Drive: chemical
Range: translunar
Crew: 3

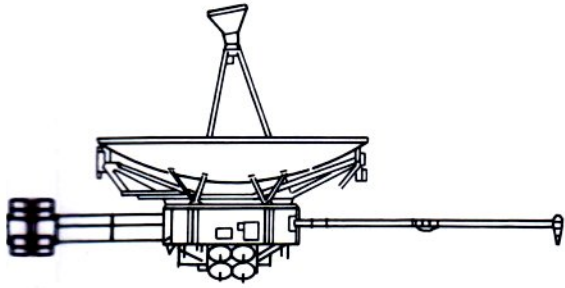

PIONEER 10
(1972)

Length: 2.7 m Drive: chemical
Mass: 259.1 kg Range: interplanetary
Armament: none Crew: none

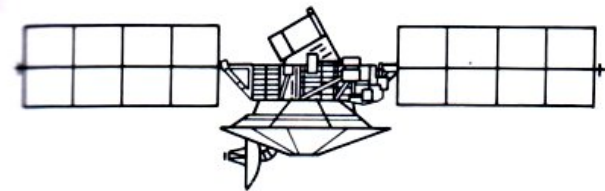

MARINER 10
(1968)

Length: 11 m Drive: chemical
Mass: 13.3 DWT Range: translunar
Armament: none Crew: 3



Voyager mockup (c.1990)

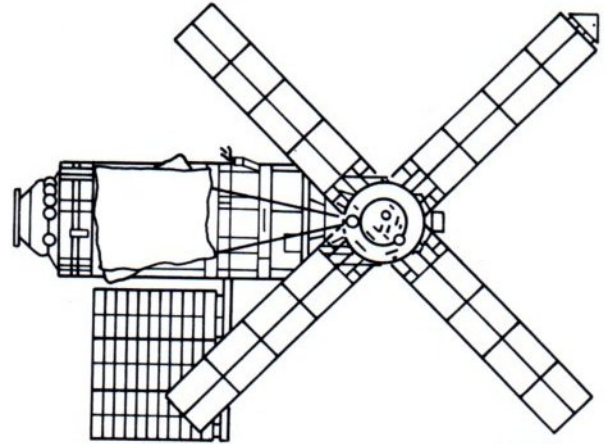

SKYLAB
(1973)

Length: 29.3 m Drive: chemical
Mass: 78 DWT Range: orbital
Armament: none Crew: 3

VIKING 1
(1976)

Length: 3.1 m Drive: chemical
Mass: 3.7 DWT Range: interplanetary
Armament: none Crew: none

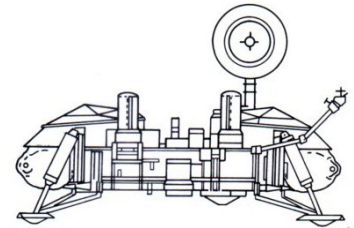

PIONEER VENUS
(1979)

Length: 132 m Drive: chemical
Mass: 314 kg Range: interplanetary
Armament: none Crew: none

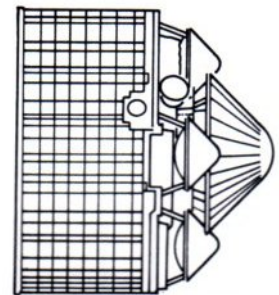

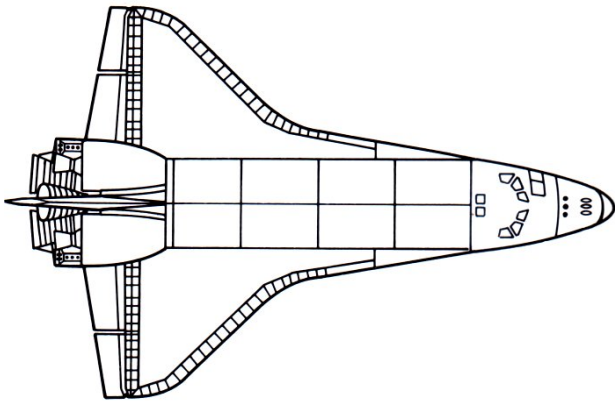

OV-100 SERIES SPACE SHUTTLE
(1980)

Length: 37 m Drive: chemical
Mass: 68 DWT Range: orbital
Armament: none Crew: 7

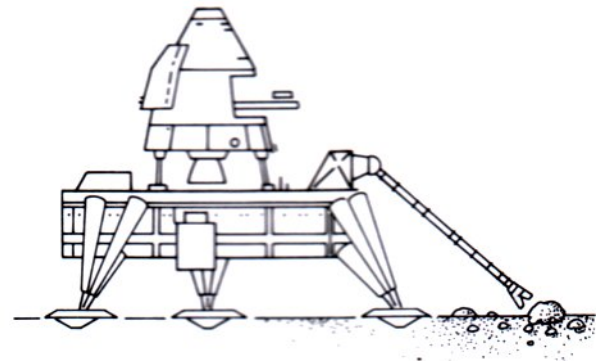

MARS SAMPLE RETURN LANDER
(1988)

Length: 4.6 m Drive: chemical
Mass: 52 DWT Range: interplanetary
Armament: none Crew: none

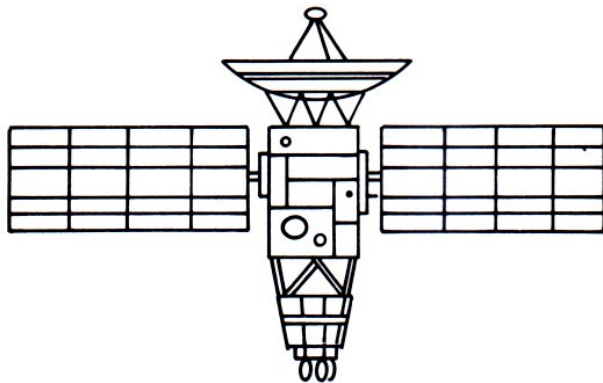

HALLEY COMET PROBE
(1985)

Length: 30 m Drive: chemical
Mass: 1.3 DWT Range: interplanetary
Armament: none Crew: none

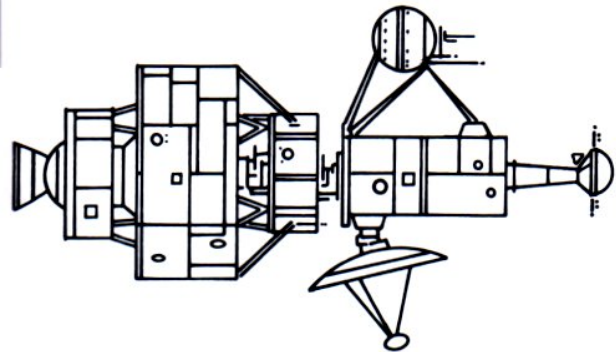

ASTEROID PROBE
(1990)

Length: 6.5 m Drive: chemical
Mass: 2 DWT Range: interplanetary
Armament: none Crew: none

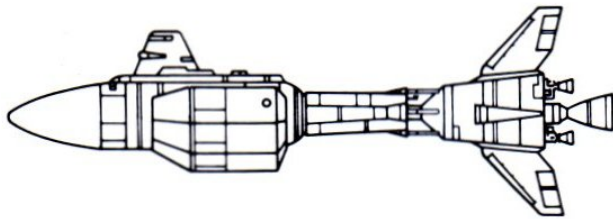

UES COPERNICUS - DY-100 PROTOTYPE
(1995)

Length: 100 m Drive: chemical/fission
Mass: 2720 DWT Range: interplanetary
Armament: none Crew: 22

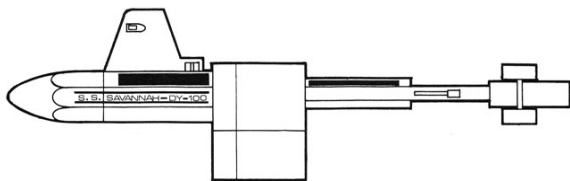

DY-100 PRODUCTION MODEL
(1996)

Length: 2.7 m Drive: chemical/fusion
Mass: 2800 DWT Range: interplanetary
Armament: none Crew: 24



NASA NTR (New Technology Rocket) fusion testbed (1995)

**ADVANCED
COMET PROBE
(2002)**

Length: 45.6m
Mass: 7.3 DWT
Armament: none
Drive: Fission
Range: ?
Crew: none

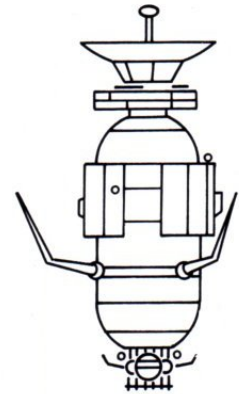

**SPACE FERRY II –
LINDBERGH CLASS
(2003)**

Length: 61m
Mass: 2750 DWT
Armament: none
Drive: Chemical
Range: Earth-Moon round trip
Crew: 4 (+ 30 passengers)

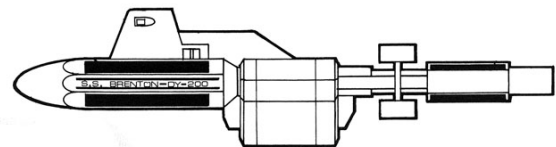
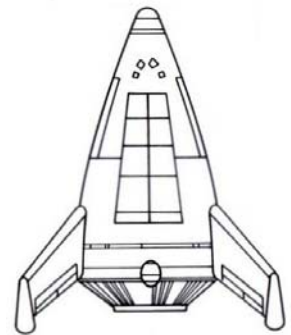

DY-200 – BRENTON CLASS
(2004)

Length: 143 m Drive: first-generation fusion
Mass: 4150 DWT Range: interplanetary
Armament: none Crew: 30

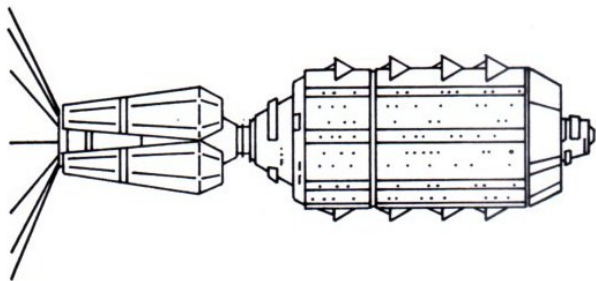

EARTH-MOON "SPACEBUS"
(2008)

Length: 90m
 Mass: 4885 DWT
 Armament: none
 Drive: combo chemical/fission
 Range: Earth-Moon round trip
 Crew: 6 (+ 24 passengers)

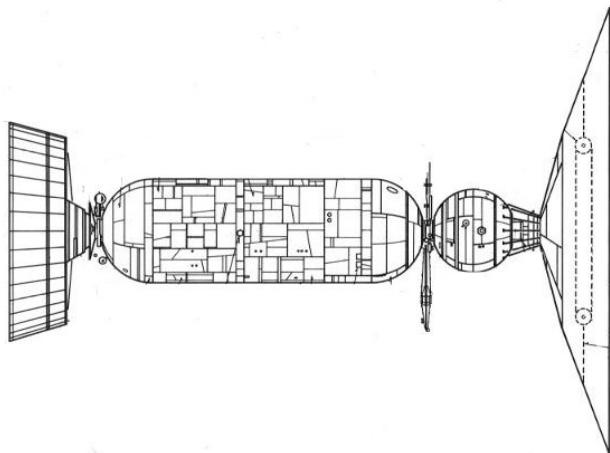

BUSSARD RAMJET COLONIZATION SHIP
(2008)

Length: x m
 Mass: x DWT
 Armament: none
 Drive: Bussard ramjet
 Range: interstellar
 Crew: 15 (& 200+ colonists)

PLANET ROVER
(2012)

Length: 16m
 Mass: 8.8 DWT
 Armament: optional
 Drive: electric
 Range: 1500 km
 Crew: 4-6

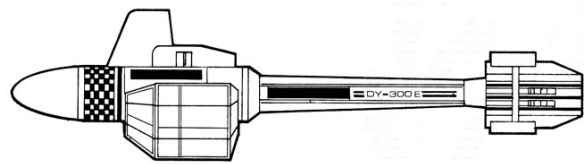
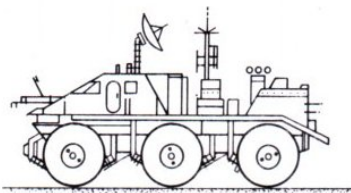

DY-300 CLASS – FAILED FIRST PROTOTYPE
(2013)

Length: 95
 Mass: 2750 DWT
 Armament: none
 Drive: fusion
 Range: untested
 Crew: 15 (test crew)

ASTEROID ROVER
(2014)

Length: 10.7m
 Mass: 3.1 DWT
 Armament: none
 Drive: chemical
 Range: interplanetary
 Crew: none

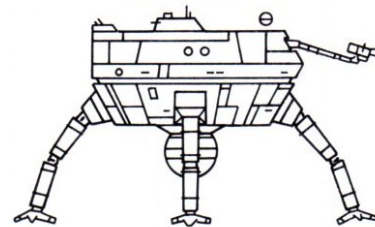

STELLAR SERIES
SPACE PROBE
(2015)

Length: 85m
 Mass: 1100 DWT
 Armament: none
 Drive: fusion
 Range: interstellar
 Crew: none

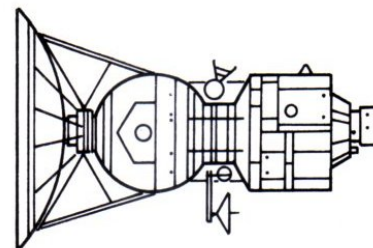

UES CYCLOPS
(2018)

Length: ? m
 Mass: ? DWT
 Armament: none
 Drive: ?
 Range: interstellar
 Crew: 5?



(similar to 2001's *Discovery*?)

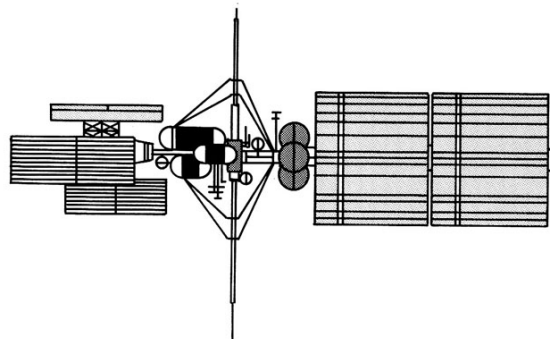

UES LEWIS & CLARK – AVENTEUR CLASS

(2018)

Length: 125m Drive: first-generation fusion
 Mass: 2810000 DWT Range: interplanetary
 Armament: none Crew: 109

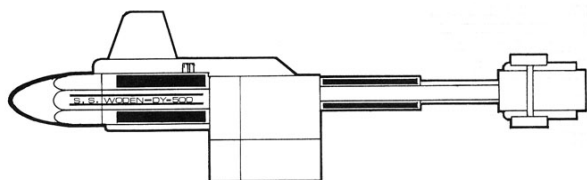

DY-500 – WHEELER CLASS

(2019)

Length: 151 m Drive: ion impulse
 Mass: 4600 DWT Range: interplanetary
 Armament: none Crew: 40



ARES IV MARS SURVEY MISSION

(2025)

Length: x m Drive: chemical/fusion
 Mass: x DWT Range: untested
 Armament: none Crew: 4



DY-245 CLASS “STRETCH” TRANSPORT

(2025)

Length: x m Drive: advanced fusion
 Mass: x DWT Range: interplanetary
 Armament: none Crew: 35



The surface of Titan



Bussard ramjet colonization ship in flight

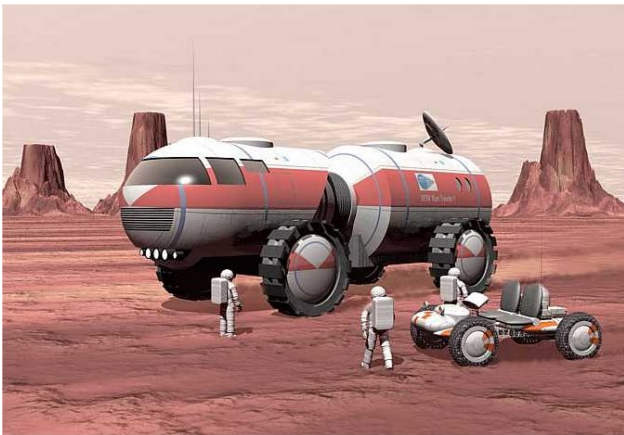

Survey team rendezvous -- Mars Base Three site (2016)



Saturn from Ganymede – Saturn-Titan Probe (2018)

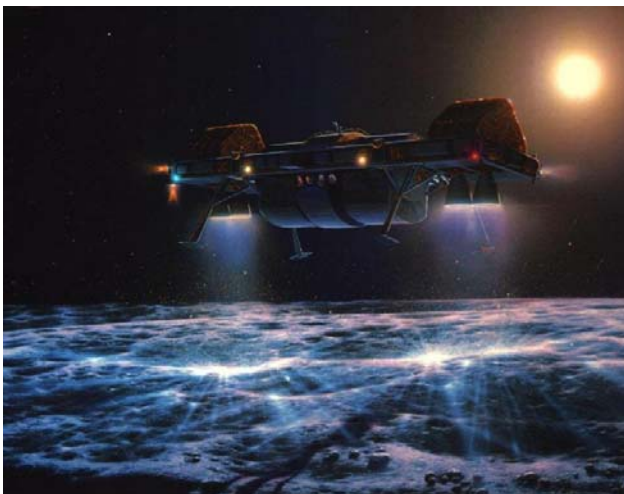

Night landing at the Martian Colonies (2025)



Lunar prospector in surface rover (2005)



The Saturnian moon of Europa



Titan sunrise – Saturn-Titan Probe (2020)

to be continued ...

ACKNOWLEDGEMENTS

VOLUME 2: 2001-2025

AUTHOR'S COMMENTS:

The story of the *Yueliang 1* was inspired in part by Arthur C. Clark's similar tale of a doomed Chinese expedition to Jupiter in the original novelization of *2010: Odyssey Two*. In that tale the Chinese were also in the race to get to *Discovery* first and were actually ahead of the *Leonov*. They stopped on Europa to refuel their engines and were destroyed by the lifeforms there. This incident was the real reason behind the *Leonov* sending a survey probe to Europa per the novel.

The United News Service comes into being as the major news service sometime around the turn of the millennia (2002-2003). It was a joint effort launched by Terra's major news organizations (AP, UPI, Reuters, BBC, CNN, FNS, etc.) at providing news from Luna and Venus, and eventually all of Terra's space colonization efforts. With World War III and the Post Atomic Horror that followed it became the major news network for the Sol System. Think of it as CNN or FNS (Fox News Service) in space.

Anyone who wants to know about the L-4 and L-5 series of space platforms should read *The High Frontier* by Gerald K. O'Neill, first published in the early 1970s. He rightly deserves all the credit for laying the groundwork for such an ambitious space colonization program. I read it when I was a child and I never forgot it. Many of the L-5 images reproduced here come directly from that work. They should also look familiar to *Gundam* fans, since the creators of that classic anime series were fans of O'Neill as well.

The *Lindbergh* class Space Ferries were all named for Terran aviation pioneers (*Lindbergh*, *Rutan*, *Wright*, *Langley*, *Mitchell*, etc.). The *Rutan* is the only one still in existence by the time of TOS/TAS. Like the space shuttle OV-099 *Pathfinder* it was a stress test body that was never meant to go into orbit. It is preserved in a static display at the Federation Air and Space Museum on Terra. It's hard to tell from Sternbach's drawing but they resembled a DC-X (Delta Clipper II) lifting body with large, fin-like stabilizer struts that also doubled as the landing gear. We know this from the tech specs; it has the same beam and draught measurements, indicating a DC-X type body.

I deliberately implied that the British Rocket Group launched the last HLV as an homage of sorts to the largely unsung British efforts at furthering space explorations. The name itself is taken directly from the *Quatermass* serials of the 1950s and is also a bit of a wink at the *Doctor Who* franchise. At one point I considered including the data on the *Guenivere One* space probe but thought that might be a bit too obvious.

The entry for the Bussard ramjet colonization ship program of the 2010s is meant to resolve the mention of such efforts in a number of later *TREK* canon and non-canon references. Four of the five known ships are the *Forty Families*, *Marilee*, *Tamahome*, and *Alamo*. No two designs were exactly alike. I used NASA's study for the *Marilee* because that seemed to best fit the diagrams as I recall them from reading the *TREK* TOS novel *Perry's Planet* in my youth.

The "SAL" computer in the first DY-300 prototype program is another reference to *2010: Odyssey Two* by Arthur C. Clarke.

Does the "late Lunar scientist Thomas Morrison" look familiar? He should. That's a still of actor Adam West from the highly acclaimed feature film *Robinson Crusoe on Mars*. I mean, why not? He died in the movie, too (grin). Be sure to look for the other more obvious *RCoM* reference I've slipped into this issue.

I can already hear some of you getting ready to flame me over the data in this volume for my data concerning the launch of the *Aries IV* mission to Mars. "That's not what they said in *Voyager*," you'll say. Remember, that show takes place in the Prime Two (Okuda) timeline, not this one. In the Prime Two timeline ISA (2018) was in existence before UESPA (2067); also, *Aries IV* was scouting locations for the first colony on Mars. Both UESPA and the Martian Colonies were already fixed features by that point in time in this – the Prime One timeline. As a result I had to come up with an alternate reason for the mission that didn't depart too much from what was shown on screen. Thus ISA comes into being as a satellite agency of UESPA and *Aries IV* is actually on a ten-year survey mission scouting additional potential colony sites. It will take the Martian Colonies two weeks to find the stranded *Aries IV* survey team because Mars is a big planet when you have only four bases to work from and the people you're looking for are practically on the other side of that world. UESPA no doubt through everything they had on Mars into the effort and they probably had to use the *Willy Ley* for orbital sweeps to aid in the search. The supposition that the *Aries IV* was on an extended survey mission, resupplying from the Martian Colonies as needed, would also help explain how the ground survey team managed to survive for two weeks before they were rescued. They had a fully stocked ground base that was never shown on screen.

The tale of the *Cyclops* came about as the result of a lone entry in Dixon's timeline (Prime Zero) concerning an early attempt at Alpha Centauri. One might be tempted to dismiss it out-of-hand as spurious. Instead, I see it as the beginning of the

development road that led to the ill-fated *Charybdis* two decades later. This of course also ties in with alien tech retrieval efforts past and present throughout the Sol System, the same that caused mankind's race to space in the Prime One timeline. I reference all of this and many other connected items in my notes under the name *Project Scylla*. This also ties in with the precursor to Section 31 and the Phobos Incident; however, I don't want to draw too detailed a picture for you. I'll just supply the lead elements and let you readers run with it from there. The other two ships in the project will probably follow the design heritage of the *Cyclops*. I utterly reject the "fake" *Charybdis* design schematic that you see all over the Internet for the admitted fraud that it is.

What about the picture of the expanded Goddard Moonbase? Yes, it *does* look awfully familiar, doesn't it? (big grin)

I followed Dixon's lead with Prime Zero and bumped the date down on the development of the *Aventeur* class (and the launch of the Saturn-Titan Probe) by a full decade. I did this for two reasons. First, this way the *Aventeur* class could be the first Terran spacecraft class fitted with "impulse drive." Second, this way it could be the first major ship class built at Utopia Planitia. The date change also dovetails nicely with certain other events regarding the discovery of alien artifacts in the Solar System.

This is just speculation on my part but I'm willing to bet Dyson-Yoyodyne played a major part in the *Aventeur* program. Those cargo modules look an awfully lot like the ones used in early DY series spacecraft. My guess is that Dyson-Yoyodyne was, among other things, a major supplier of cargo modules of all sizes and types for the Terran spacecraft of the day. Who says they were purely a spacecraft building consortium?

The picture of the UESF drop ship arriving at Base Sidonia is that of a U.S. Colonial Marines dropship at the LV-246 atmospheric processing station from the movie *Aliens*. Just another one of my little jokes (grin).

The whole business with the Saturn-Titan Probe and the ruins of the Builders was partly inspired by the original SFC and by an interesting paper on the Enterprise Mission website. It postulates that the Saturnian moon of Iapetus might be the ruin of a vast alien spaceship. I don't know if it's true or not; however, it fits in nicely with the materials as presented in SFC. As it works out 2020-2021 is the Prime One's "*2001*" if you will. All of the major incidents involving extraterrestrial life take place within that timeframe, Saturn-Titan in particular. As to the mystery of the Builders? I'm sure the folks who were running Project Scylla knew more than they let on at the time. They might have been the Preservers or some other long-dead alien culture. I'll let the rest of *TREK*dom figure that one out.

The DY-245 "stretch" transport was mentioned but never shown in the TNG episode "Up the Long Ladder." The visual comes courtesy of the Journal for Applied Treknology. They also deserve credit for both of the Dyson-Yoyodyne logos used in this

work. My stats and class history are entirely speculative and many not be accurate. I will correct this in later editions if I can.

I'm trying an experiment in this issue. At the back of this volume you find a new SCHEMATICS section. As of right now this includes Rick Sternbach's spacecraft drawings from the old SFC to date plus Lawrence Miller's updates from the *Starfleet Tactical Database Volume 2* and whatever else I've had to come up with. That way I won't be leaving out as much from the old SFC. I'd like to expand it to some "Reverend" style schematic pages for each individual ship or transport type listed; however, I lack the talent. Maybe one of you?

Regards,

- Richard E. Mandel



The Martian sunset as seen from the *Martian Genesis* (2010)

SPECIAL THANKS TO:

Apple Computer, Inc.
HP/Compaq Computer, Inc.
Eric Kristiansen
James Dixon
Encyclopedia Astronautica
Ex Astris Scienta
Stan and Fred Goldstein
Walter Irwin and G.B. Love
Timo Saloniemi
Aridas Sofia
Rick Sternbach
The United States Air Force
The United States Army
Wikipedia

IMAGE SOURCES:

Defense Tech: Space Archives
Fox Entertainment
The Enterprise Mission
ITC Entertainment
The Marshall Space Flight Center
The National Aeronautics and Space Administration
The National Archives
Paramount Pictures
Universal Pictures

CONCEPTUAL ARTWORK AND SCHEMATIC SOURCES:

Jeff Bateman
Joe Bergeron
Journal for Applied Treknology
Chris Butler
Michael Carrell
Defense Tech: Space Archives
Don Davis
Encyclopedia Astronautica
Lawrence Miller
The Enterprise Mission
M. J. Graham
Tom Newsom
Rick Sternbach
The United States Air Force Art Collection

CONTACT INFO:

Want to contribute to the *Federation Spaceflight Chronology*?
You can find me on the FRS Online or Star Fleet Network
forums. If you prefer direct contact then you can reach me at
rtroude@yahoo.com

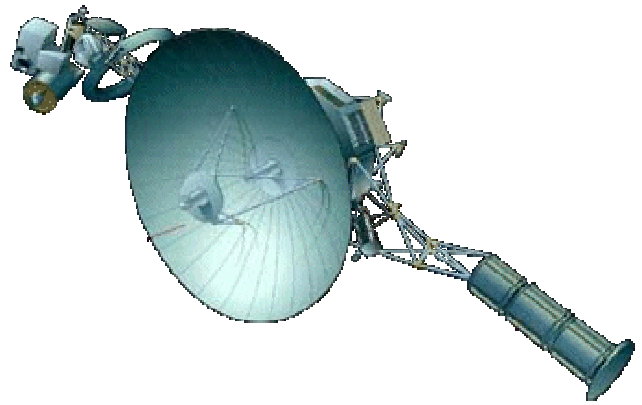

NASA's Voyager VI space probe



UESF Marine recruitment poster art (2010)

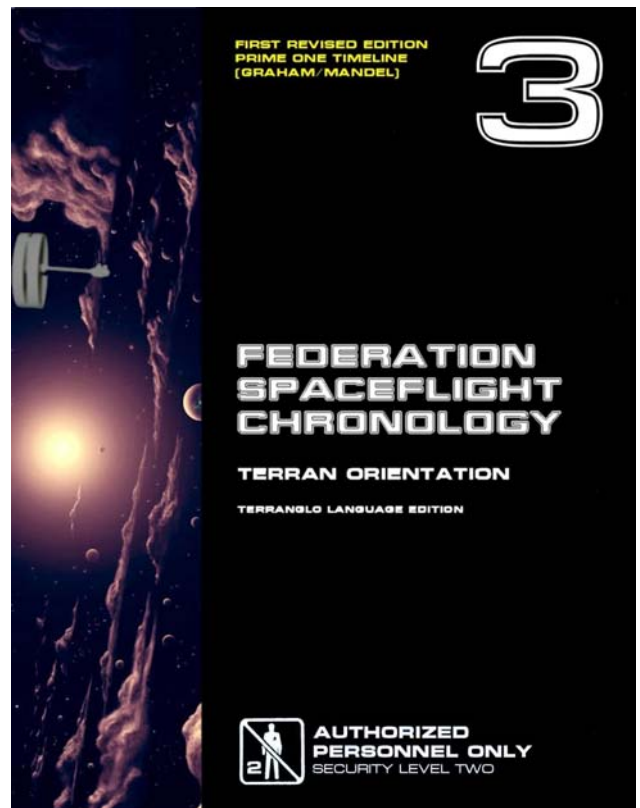

coming soon

