

Kansas Class Freighter

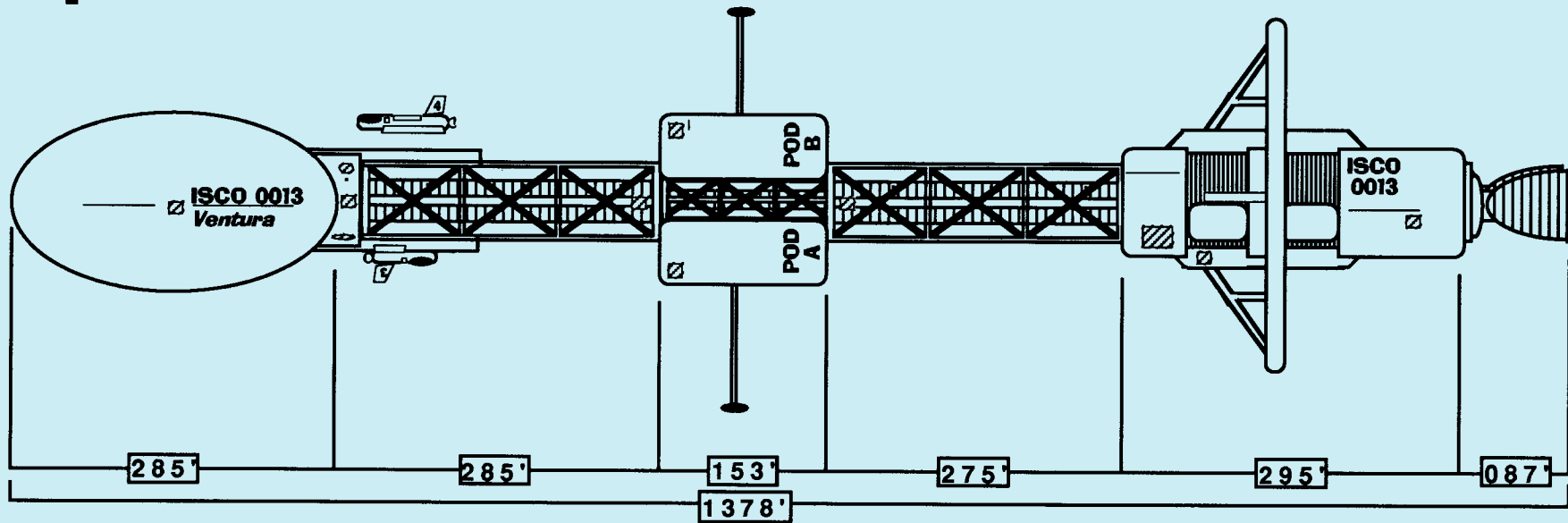

Kansas Class 'B' Blueprints

Deck Plans for a 1380' Star Freighter



1 22 **SIDE VIEW**
Sheets



KANSAS CLASS B
(ISCO 00--)

STARSHIP VENTURA ISF 0013

Design by MC Services & TTS Graphics
Cleveland Star Yards LeGrange 3

Kansas Class B Deckplan Data Codes

AL	Air Lock	ENG	Engineering Central Control	OBS	Observation Lounge
ALS	Air Lock Storage	ENO	Engineering Offices	OFA	Organic Fabrication
ARC	Air (and Gas) Recycling Center	EPB	Emergency Batteries	OFS	Organic Fabrication Supply
ARO	Atmospheric Research Center	EQ	Equipment	OM	Officers Mess
AXB	Auxiliary Bridge	ER	Elevator Repair	PES	Physical Fitness Storage
ASL	Atmospheric Survey Lab	ES	Elevator Storage	PHL	Physics Lab
AZE	Astronomy Equipment	EVB	External Vehicle Bay	PHO	Physics Office
AZL	Astronomy Lab	EVE	EVA Equipment	PHS	Physics Supply
AZO	Astronomy Office	EVP	EVA Preparation	PSL	Planetary Survey Lab
BA	Batteries	FAO	First Aid Office	PSO	Planetary Survey Office
BAA	Batteries, Nuclear	FA	First Aid Station	PKG	Packaging
BFC	Briefing Room	FAS	First Aid Supply	PKS	Packaging Supply
BIO	Biology Lab	FC	Forward Scanner Array	PV	Private Viewing Room
BIS	Biology Supply	FCE	Forward Scanner Equipment	PSH	Psychiatrists Office
BLI	Boarding Lounge	FCM	Forward Scanner Monitor	PTR	Physical Fitness Storage
BLO	Boarding Lounge Info Center	FOQ	First Officers Quarters	PTT	Physical Therapy
BLV	Boarding Lounge VIP	FP	Food Preparation System	Q	Crew Quarters
BOS	Botany Supply	FPK	Food Prep Kitchen	REC	Radiation Entrapment Control
BRI	Bridge	FPR	Food Fabricator/Replicator	REF	Radiation Entrapment Field
BRL	Bridge Lounge	FPC	Food Processing Center	RHB	Rehabilitation Center
CA	Cargo Lift	FRC	Fabrication Area	RHS	Rehabilitation Supply
CAR	Cargo Area	FUE	Fusion Reactor, Emergency	ROA	Robotics Assembly
CBI	Cargo Bay Internal	FUM	Fusion Reactors Monitor	ROC	Robotics Control Center
CBR	Circuit Breaker Room	FUP	Fusion Reactors Port	ROM	Robotics Maintenance
CBM	Circuit Breakers Main	FUS	Fusion Reactors Starboard	ROR	Robotics Recharge
CCM	Cooling Ring Monitors	GEL	Geology Lab	ROW	Robotics Workshop
CCE	Cooling Ring Equipment	GEO	Geological Survey Office	RTK	Ships Store
CCE	Cooling Ring Systems	GST	Gas Storage	SC	Shuttle Control & Monitor
CCS	Cooling Ring Systems	GYM	Gymnasium, Fitness Center	SCA	Ship's Main Computer
CCQ	Chief Engineers Quarters	HSF	Hydroponic Soy Farm	SCB	Ship's Main Phase/Nav Comp
CHL	Chemistry Lab	HSY	Hydroponics Yeast Vats	SCC	Computer Control Center
CHO	Chemistry Office	HT	Hot Tub	SCE	Ship's Log & Archived Data
CHS	Chemistry Supply	HTS	Hot Tub Supply	SCI	Ship's AI Computer
CML	Chief Medical Officer's Lab	HYL	Hydroponics Lab	SCP	Secondary Phase Computer
CMO	Chief Medical Officer's Office	HYO	Hydroponics Office	SCS	Secondary Computer
CMQ	Chief Medical Officer's Quarters	HYP	Hydroponics Processing	SCZ	Computer Support Office
CMR	Cargo Monitoring Room	HYS	Hydroponics Storage	SDF	Storage Device Fabrication
CST	Cold Storage	IOF	Inorganic Fabrication	SDP	Storage Device Processing
CON	Confidence Room	LAU	Laundry	SDR	Storage Device Recovery
CMC	Captain's Quarters	LMO	Library	SEC	Security Computer
CMO	Captain's Office Officer's Office	LK	Protective Suit Locker	SEB	Security Brig
CMQ	Command Officer's Quarters	LOU	Lounge	SEM	Security Munitions Store
CRA	Cargo Assembly Bay	LSL	Life Sciences Lab	SEO	Security Office
CRB	Cargo Recovery Bay	LSS	Life Sciences Office	SES	Security Sub Station
CRC	Cargo Computer & Office	LSS	Life Science Supply	SEW	Security Waiting Area
CRF	Cargo, Refrigerated	L&S	Locker & Showers	SEZ	Security Weapons Locker
CRI	Cargo Inspection Bay	MON	Monitor Center	SFC	Secondary Fuel Compartment
CRL	Cargo Live Storage	MEA	Autodoc Units	SLL	Stairs Lower Level
CRM	Cargo Monitor Center	MEB	Triage	SO	Security Offices
CRO	Cargo Office	MED	Child Care	STO	Storage
CRS	Cargo Secure Area	MEF	Dentistry	STV	Ship TV Studio
CRY	Cryonics/Hibernation	MEF	First Aid	SUF	Suit Repair Facility
CST	Cold Storage	MEG	Optometrist	SUL	Stairs Upper Level
CT	Computer Terminal Station	MEL	Health Office	SUR	Space Suit Repair
CWB	Open Work Bay	MEO	Labs	SUS	Space Suit Storage
DEA	Defense Weapons Assembly	MEP	Office	THE	Ship's Theatre & Chapel
DEB	Defense Engineering	MEQ	Psychologist	THS	Theatre, Stage
DEE	Defense Equipment	MEQ	Quarantine	TRO	Tool Room
DEF	Defense Control	MEV	Medical Officer's Quarters	TL	Toilet
DEL	Defense Weapons Locker	MEX	Observation	UL	Uniform Center
DES	Defense Storage	MEX	Med Scan Tech	WR	Waste Recovery & Recycling
DEW	Defense Weapons Bay	MES	Surgery	VIP	VIP Quarters
DCC	Decompression Control	MEW	Medical Ward	WPA	Work Pod Airlock
DCN	Decontamination	MFD	Main Engine	WPD	Work Pod Elevator Down
DCM	Decontamination Monitoring	MFF	Main Fuel Compartment	WPU	Work Pod Elevator Up
E	Elevator	MPR	Multi Purpose Room	WPP	Work Pod Prep
ELC	Electronic Auto-Fabricator	MTA	Auto Smelters	WPR	Work Pod Repair
ELF	Electronics Fabrication	MTF	Metallic Fabrication	WPS	Work Pod Storage
ENG	Emergency Engineering Office	MTL	Metallurgy Lab	XZ	Stellar Cartography
EMM	Emergency Engineering Computer	MTS	Metallurgy Supply		
EMQ	Emergency Quarters	OFF	Office		
EMS	Emergency Supply	OWB	Open Work Bay		

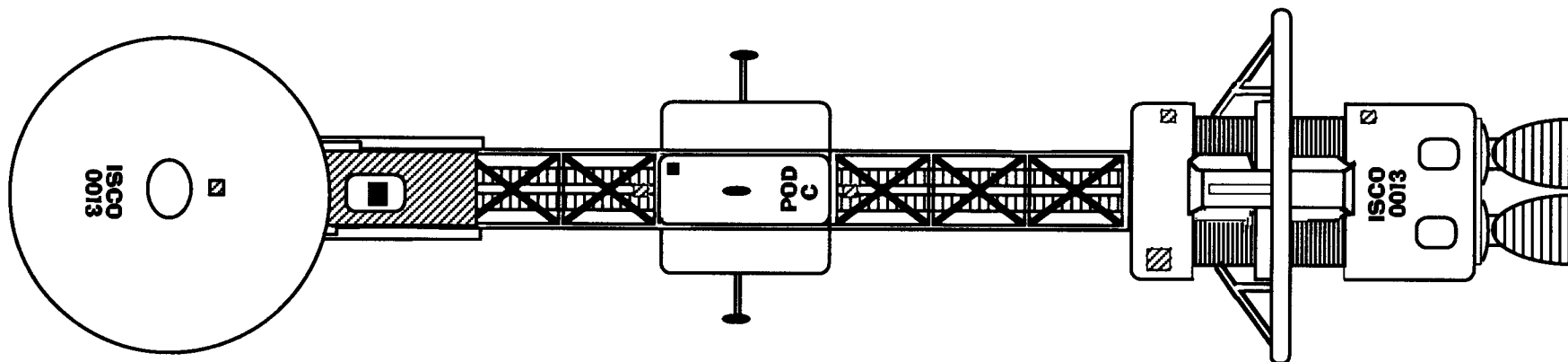
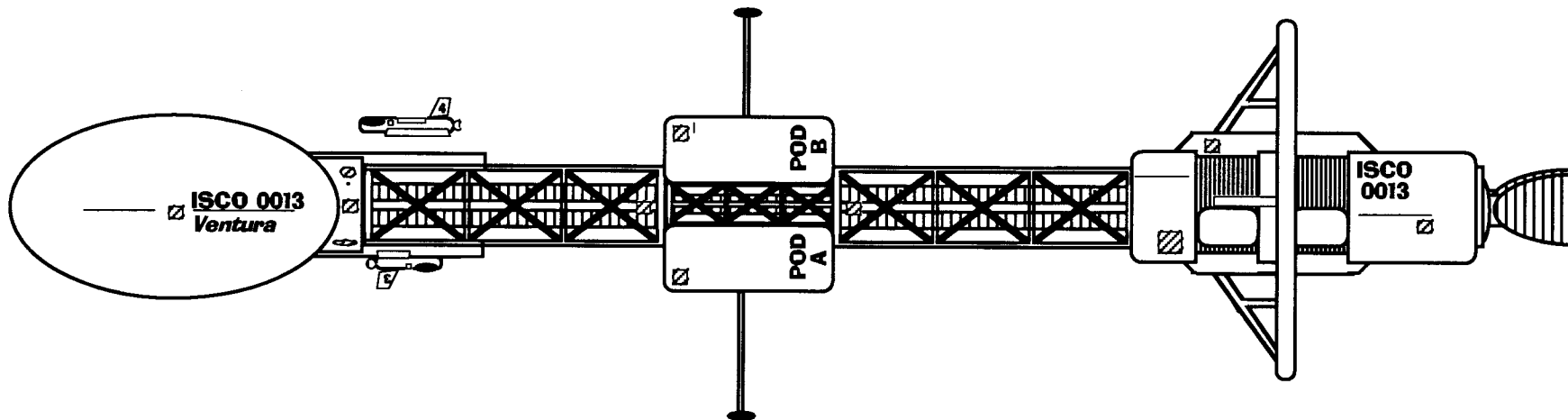

**KANSAS CLASS B
(ISCO 00--)**

STARSHIP VENTURA ISF 0013

Design by MC Services

Cleveland Star Yards LeGrange 3

1 of 22 **SIDE & TOP VIEW**

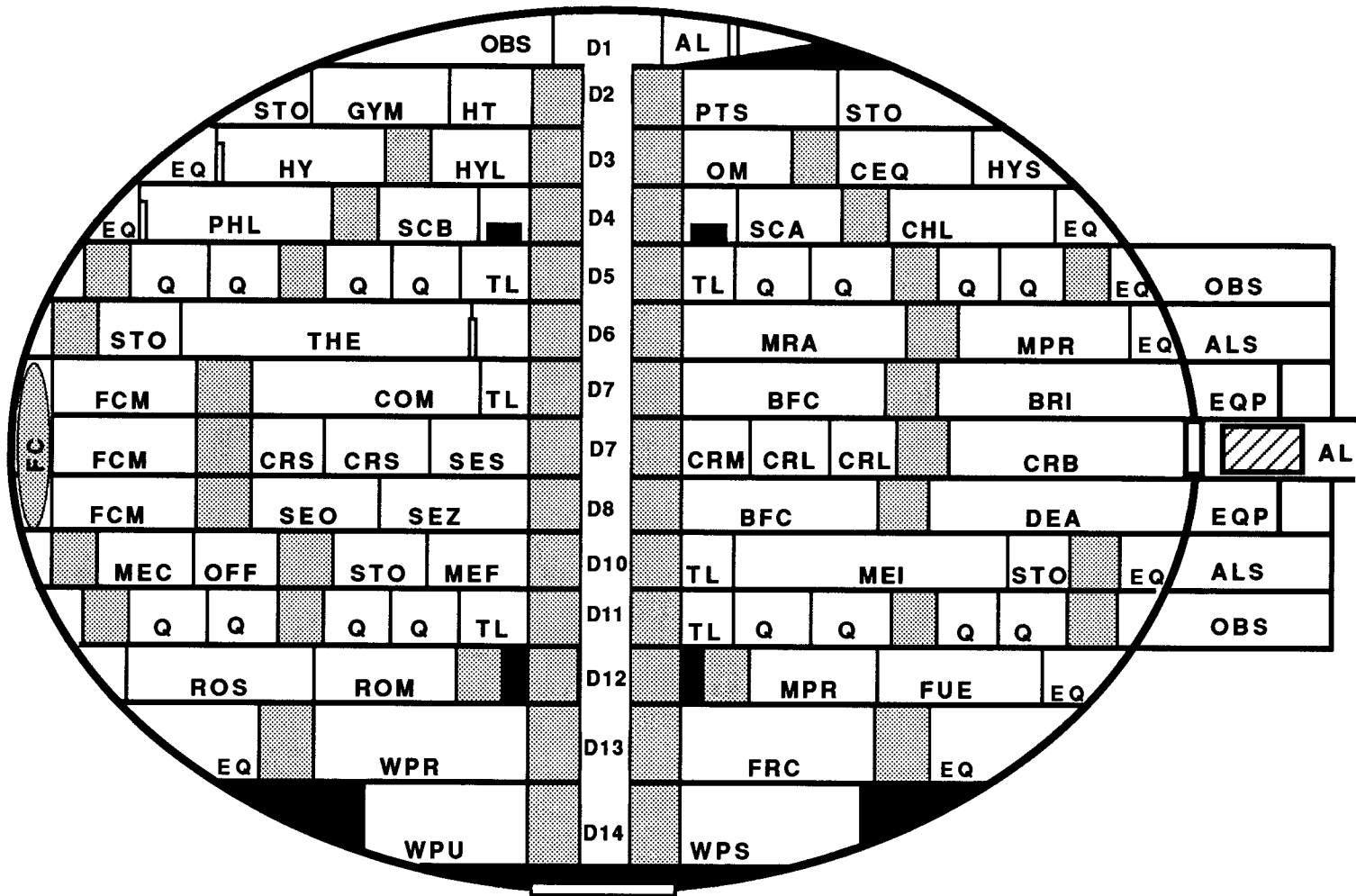

**KANSAS CLASS B
(ISCO 00--)**

STARSHIP VENTURA ISF OOB

Design by MC Services

Cleveland Star Yards LeGrange 3

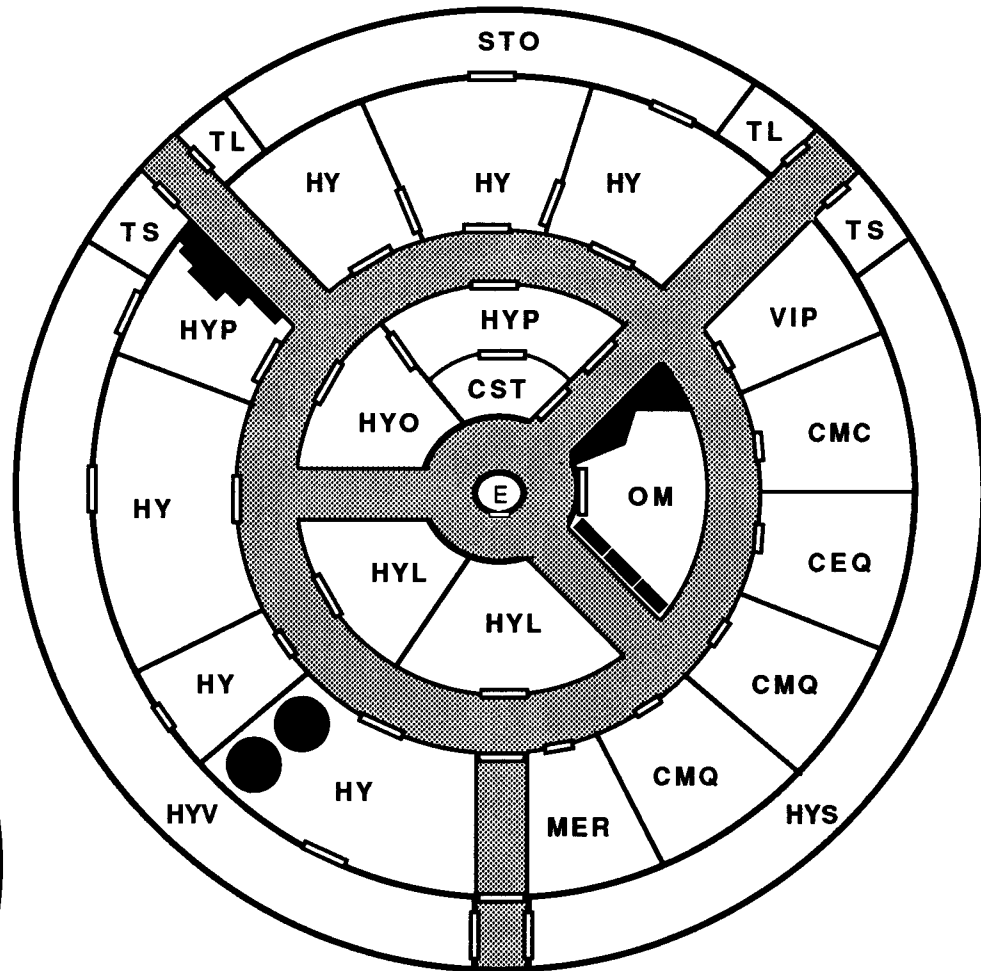
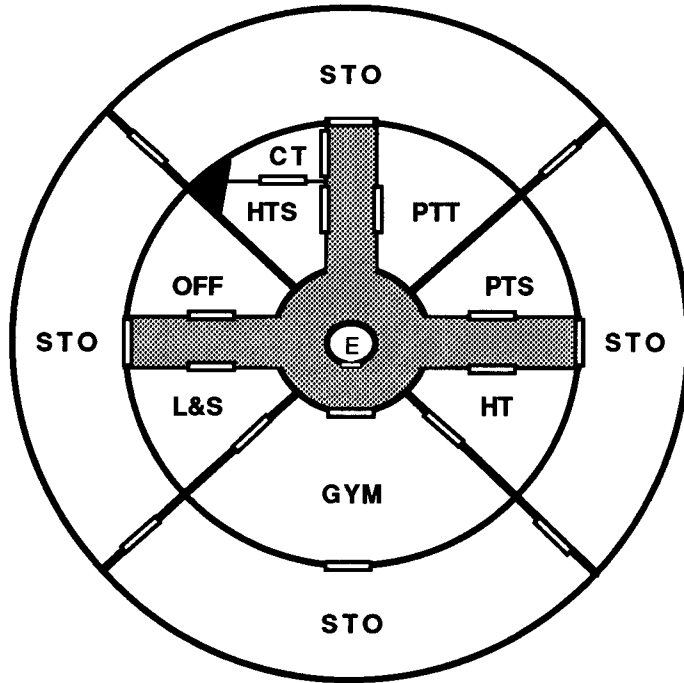
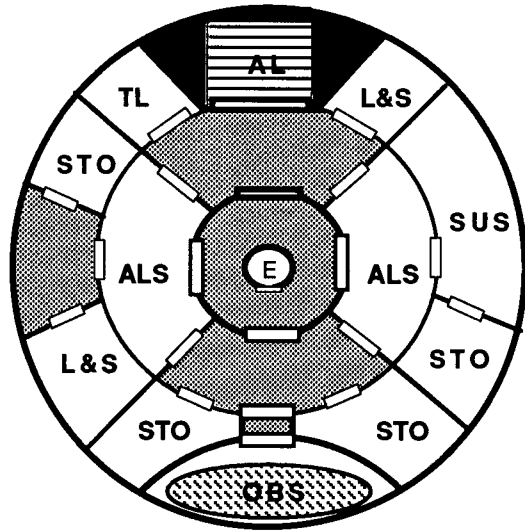

**KANSAS CLASS B
(ISCO 00--)**

STARSHIP VENTURA ISF OOB

Design by MC Services
Cleveland Star Yards LeGrange 3

3 of
22 DECK 1,2,3

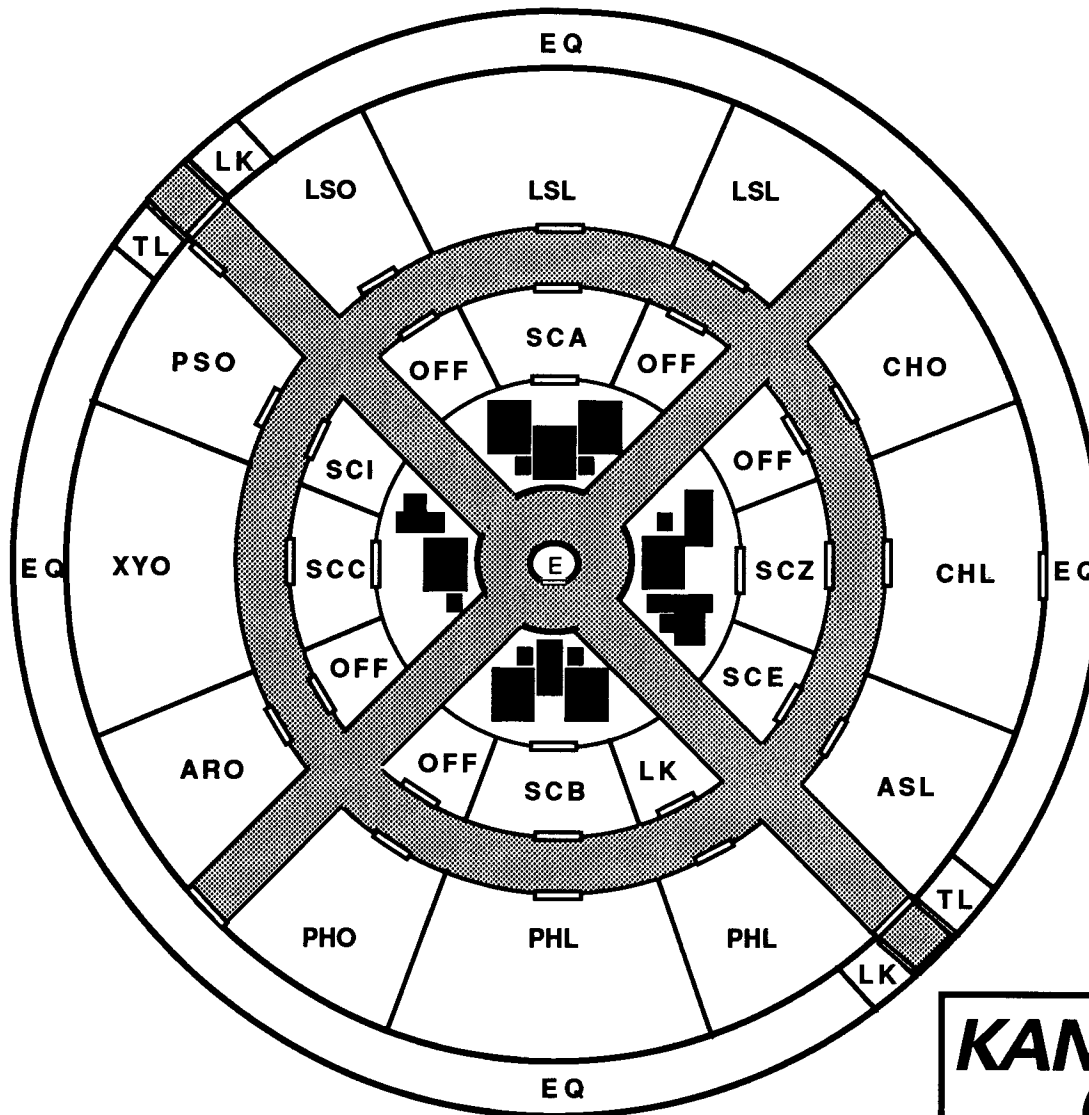

KANSAS CLASS B
(ISCO 00--)
STARSHIP VENTURA ISF 00B
 Design by MC Services
 Cleveland Star Yards LeGrange 3

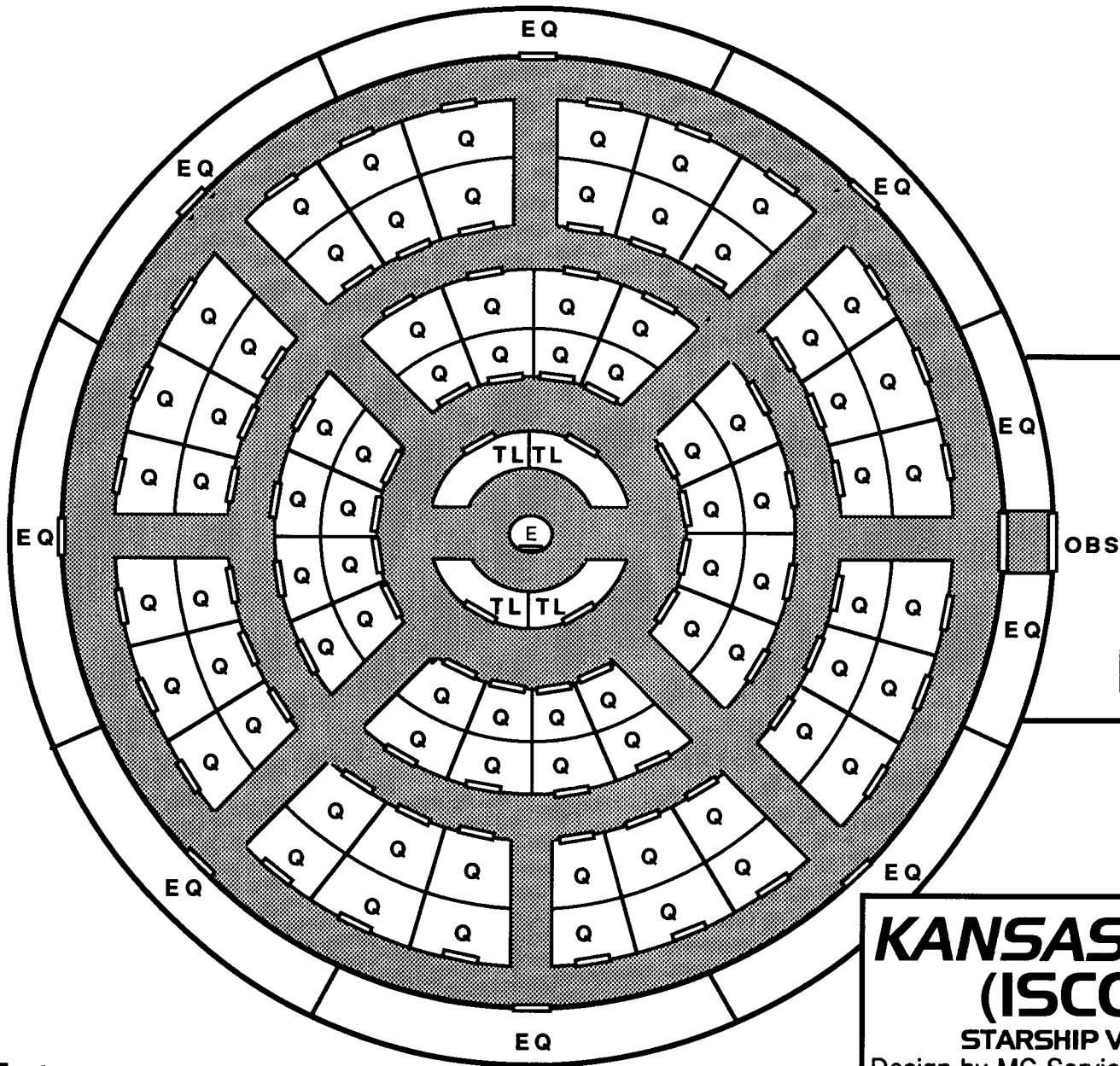

KANSAS CLASS B
(ISCO 00--)
 STARSHIP VENTURA ISF OOB
 Design by MC Services
 Cleveland Star Yards LeGrange 3

5 of
22 DECK 5

© 1995 Tri Tac Systems

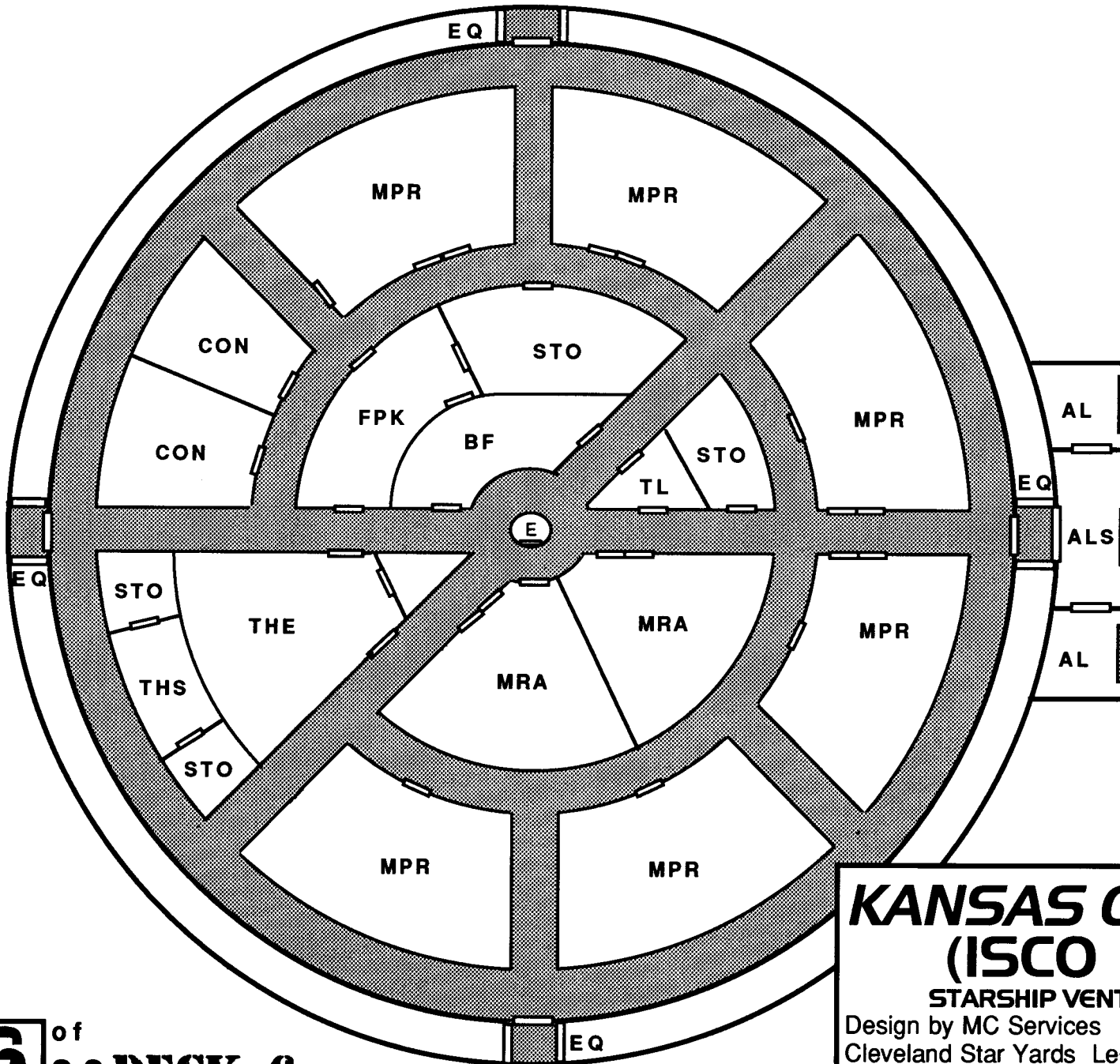

6 of
22 DECK 6

KANSAS CLASS B
(ISCO 00--)
 STARSHIP VENTURA ISF 00B
 Design by MC Services
 Cleveland Star Yards LeGrange 3

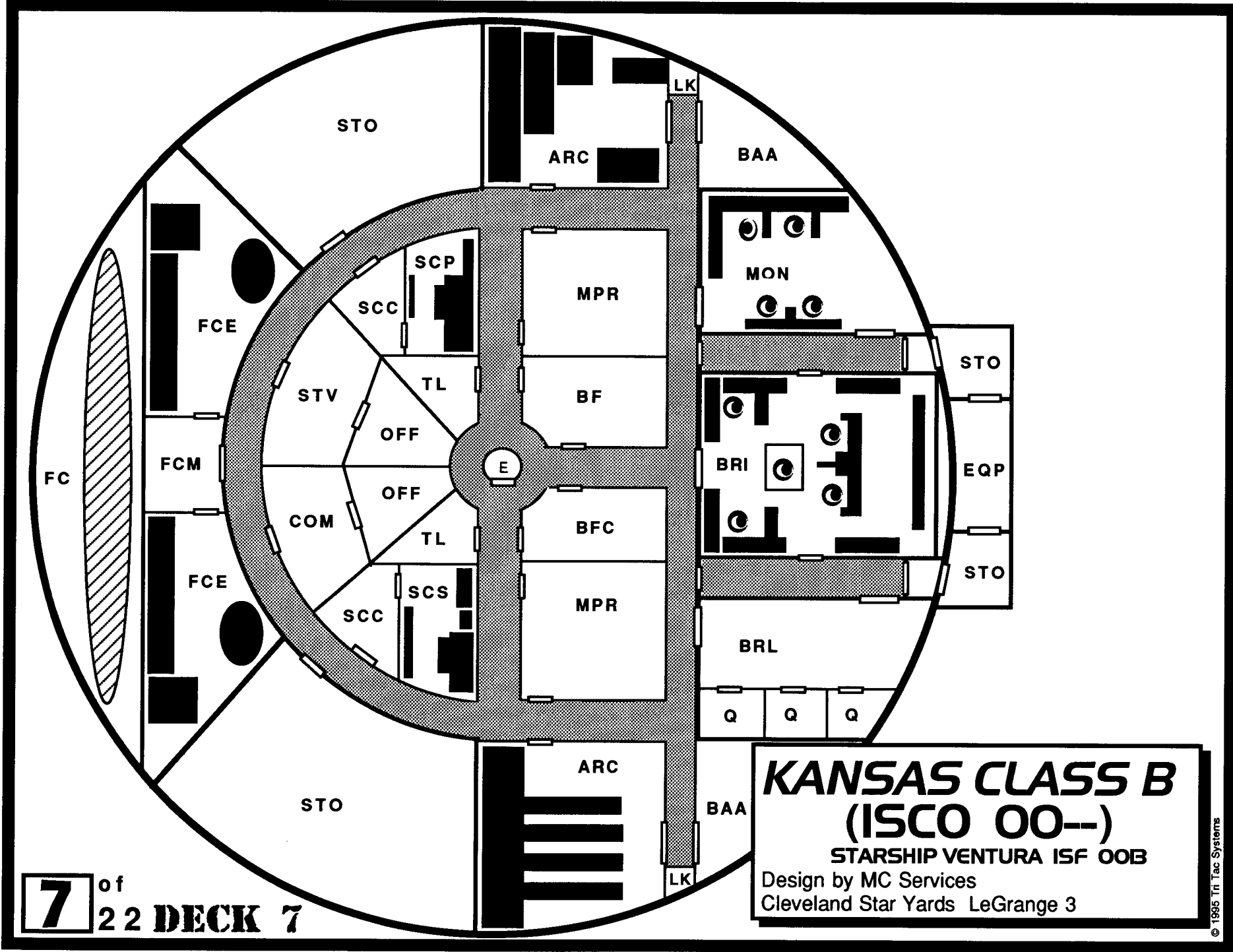

7 of 22 **DECK 7**

KANSAS CLASS B
(ISCO 00--)
 STARSHIP VENTURA ISF OOB
 Design by MC Services
 Cleveland Star Yards LeGrange 3

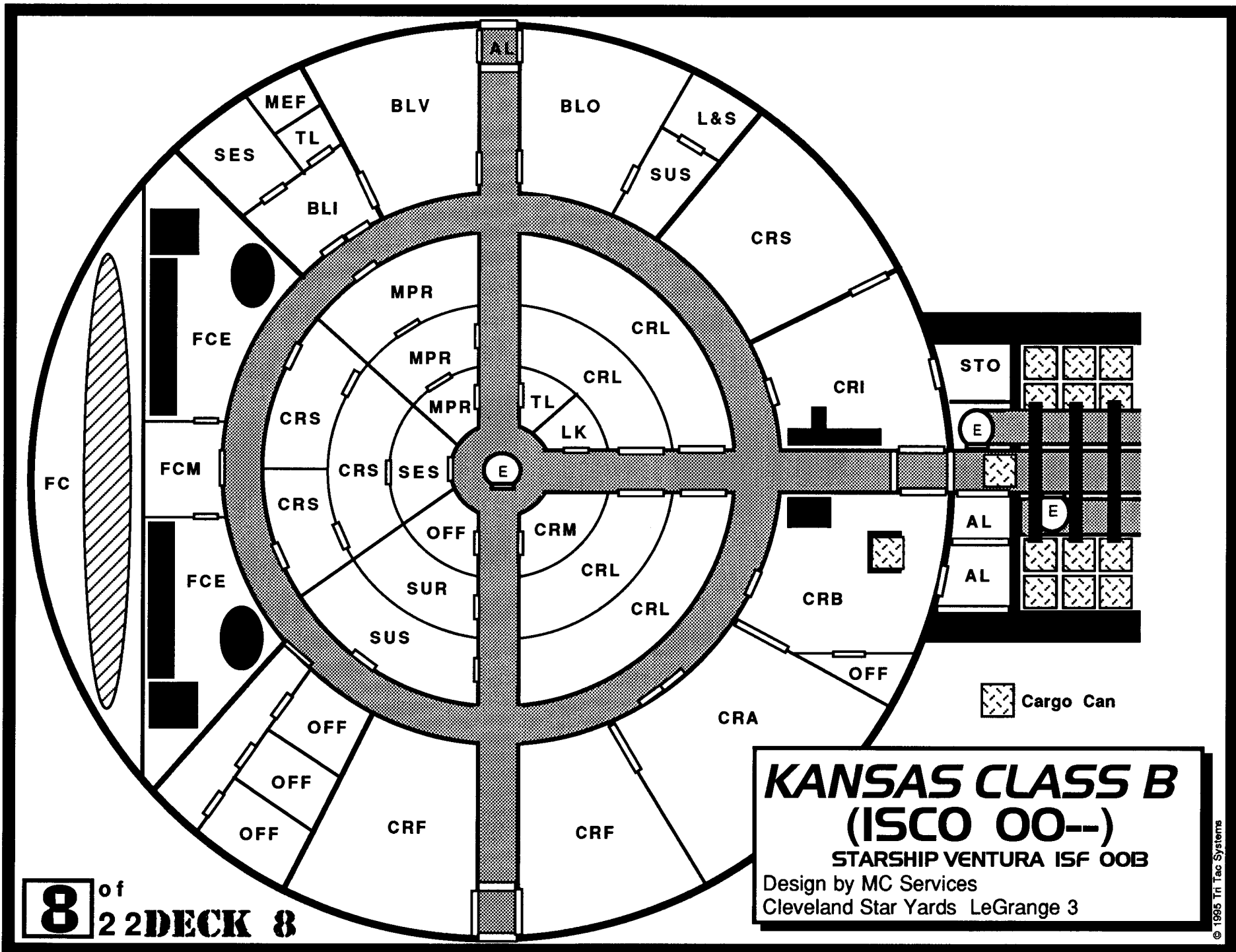

KANSAS CLASS B
(ISCO 00--)
 STARSHIP VENTURA ISF OOB
 Design by MC Services
 Cleveland Star Yards LeGrange 3

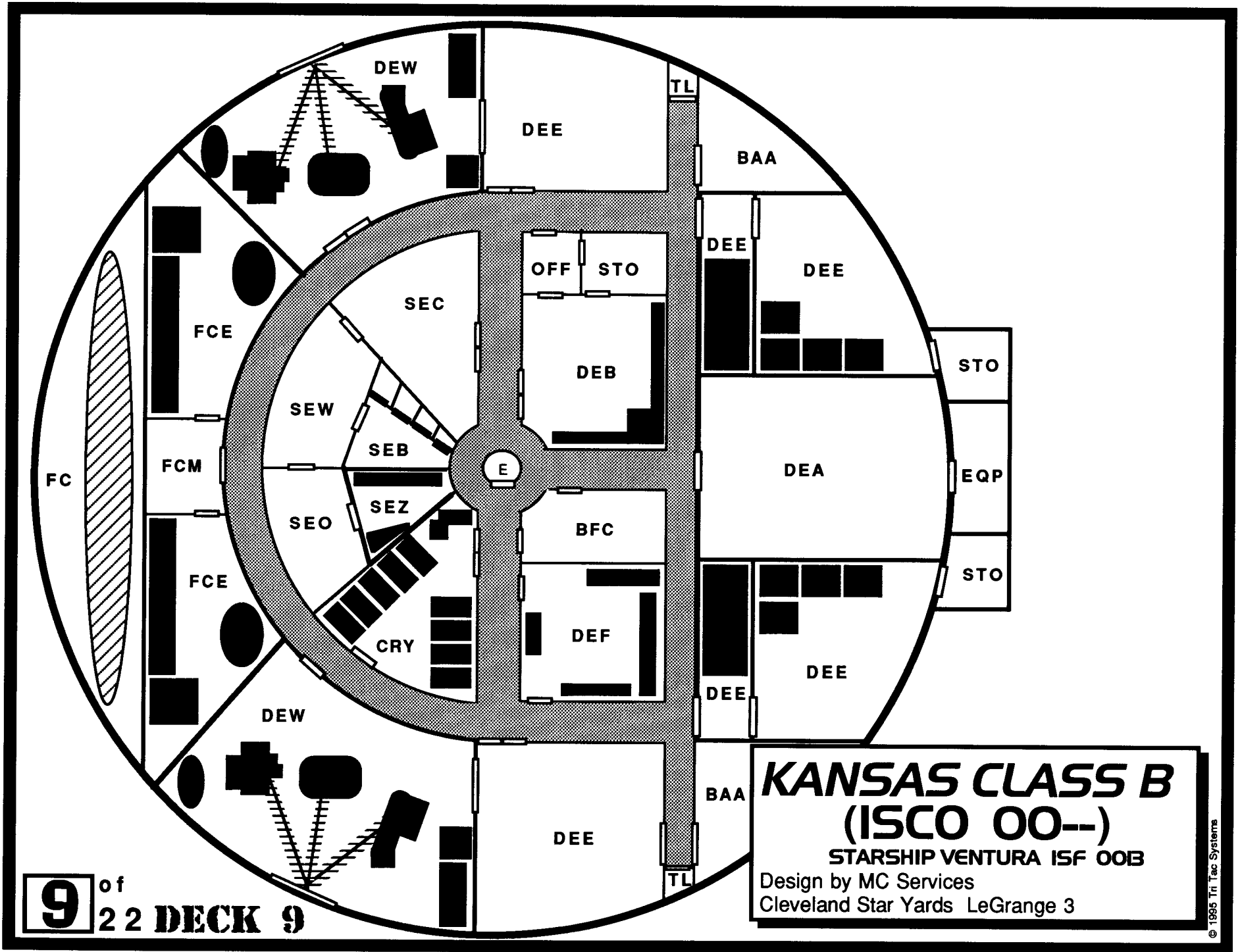

9 of 22 **DECK 9**

KANSAS CLASS B
(ISCO 00--)
 STARSHIP VENTURA ISF 00B
 Design by MC Services
 Cleveland Star Yards LeGrange 3

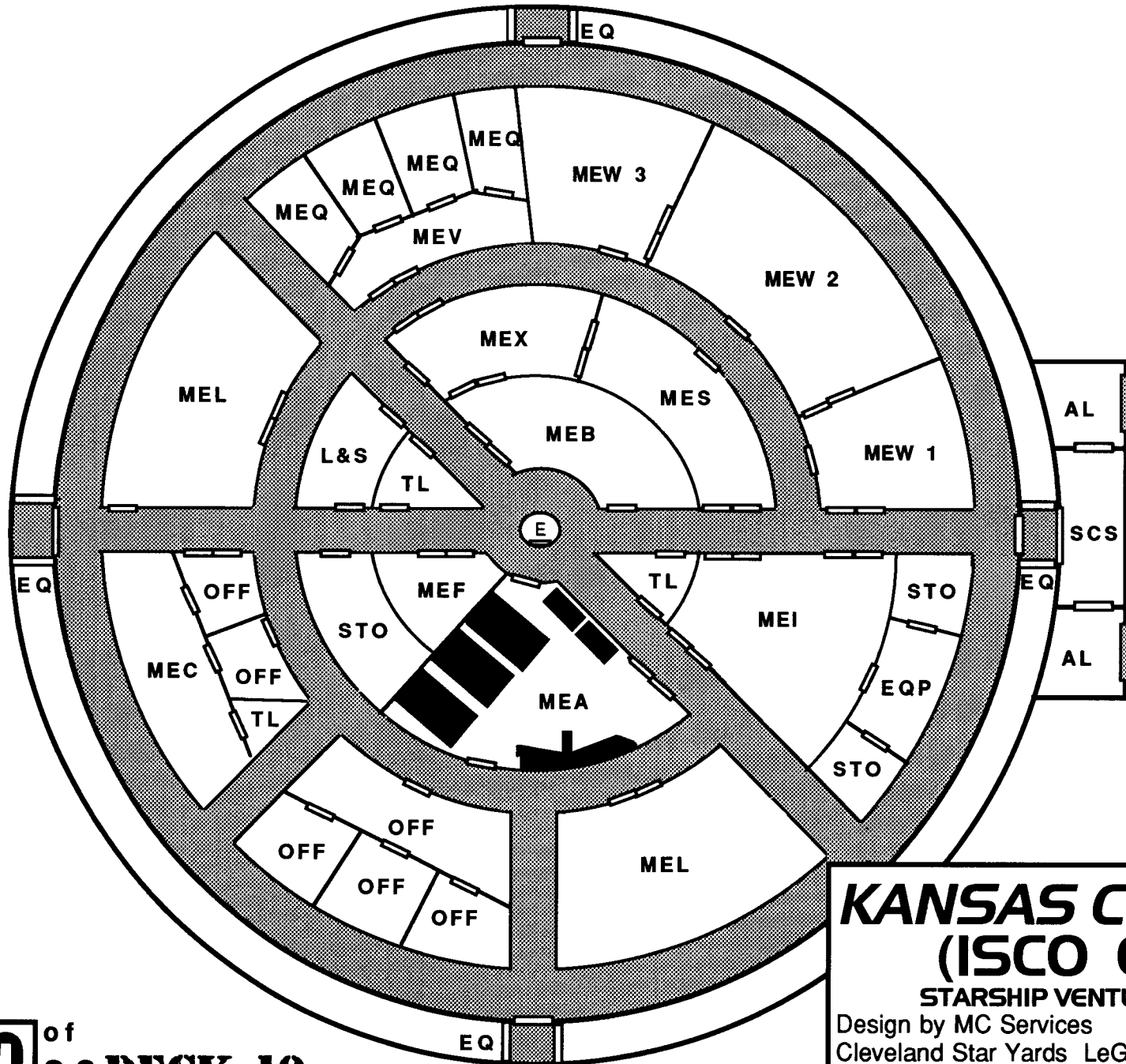

10 of
22 **DECK 10**

KANSAS CLASS B
(ISCO 00--)
 STARSHIP VENTURA ISF 00B
 Design by MC Services
 Cleveland Star Yards LeGrange 3

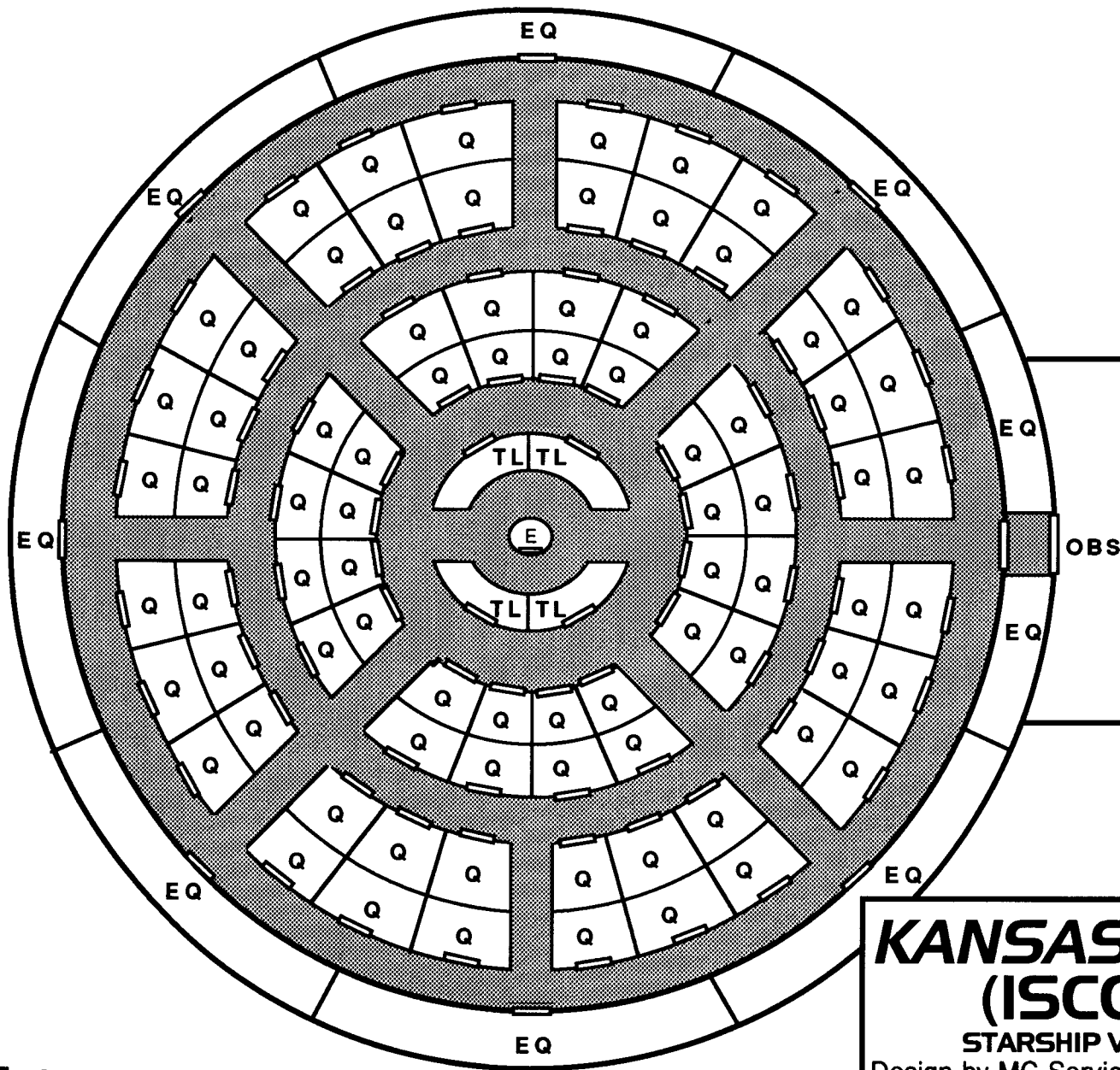

11 of
22 **DECK 11**

KANSAS CLASS B
(ISCO 00--)

STARSHIP VENTURA ISF OOB

Design by MC Services
Cleveland Star Yards LeGrange 3

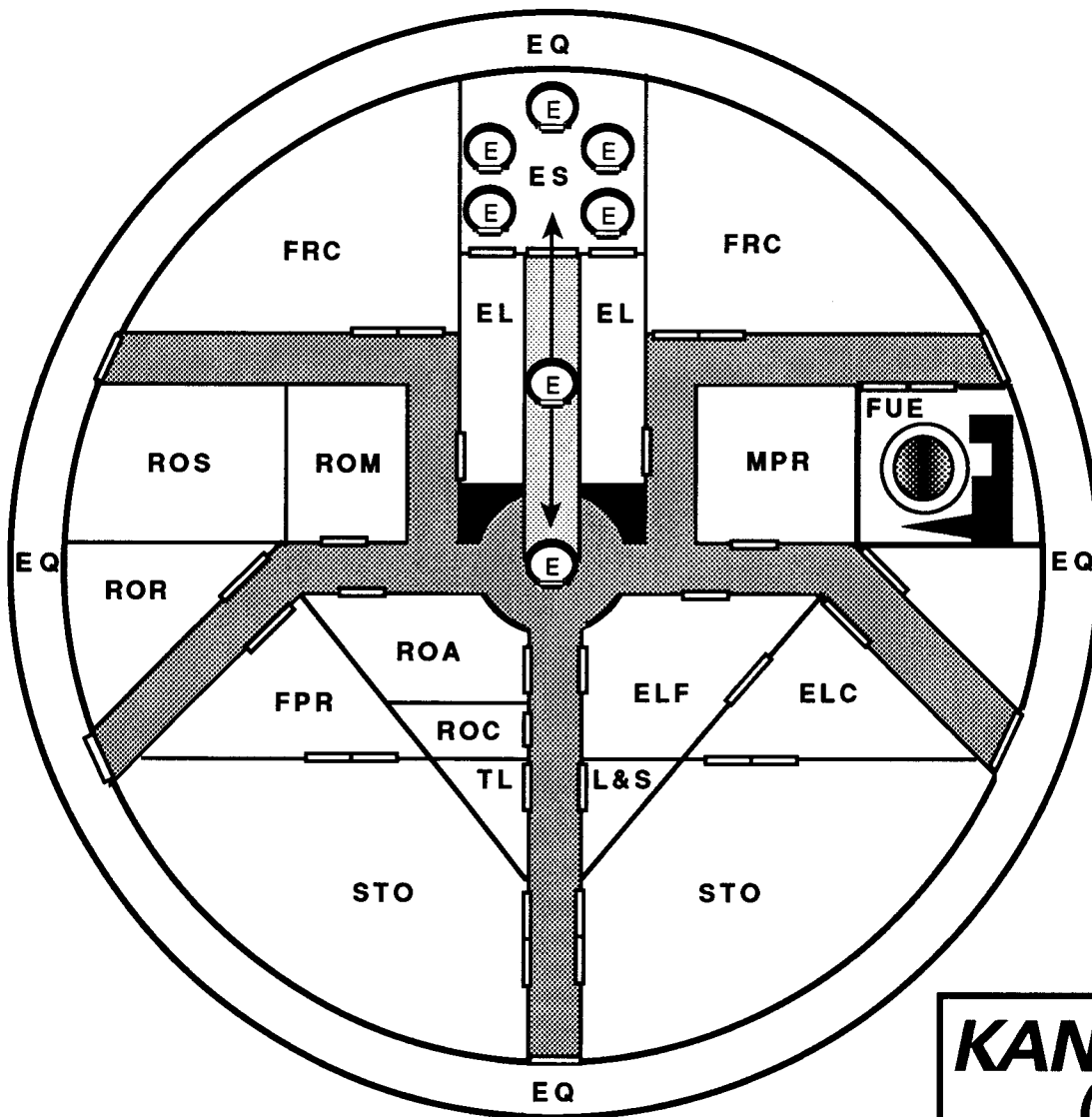

12 of
22 DECK 12

KANSAS CLASS B
(ISCO 00--)
 STARSHIP VENTURA ISF 00B
 Design by MC Services
 Cleveland Star Yards LeGrange 3

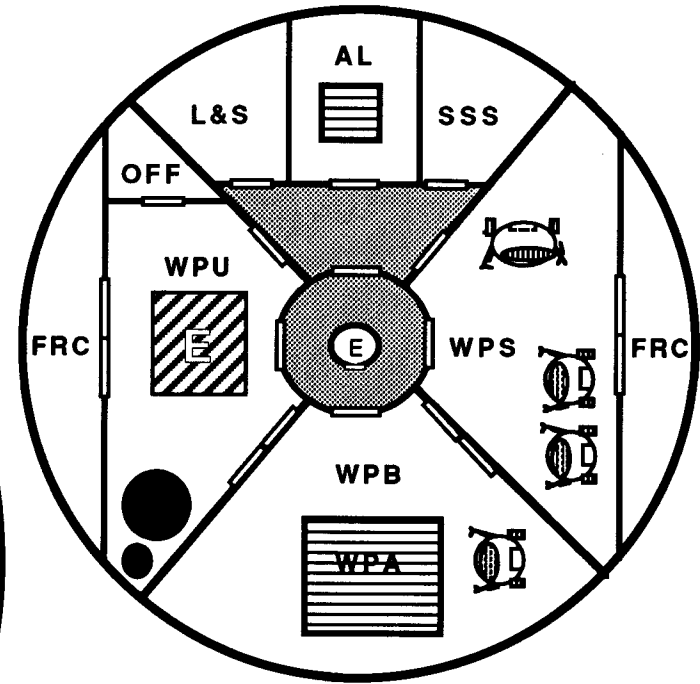
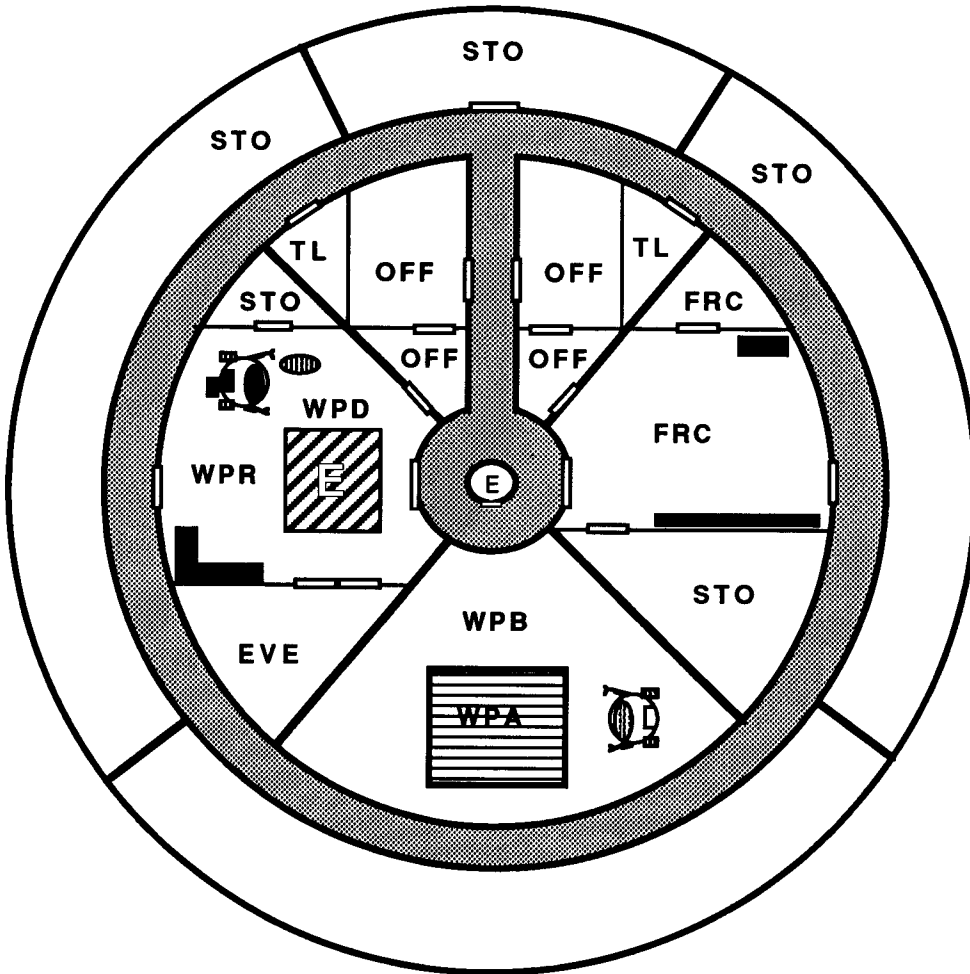

13 of
22 DECK 13 & 14

**KANSAS CLASS B
(ISCO 00--)**

STARSHIP VENTURA ISF OOB

Design by MC Services

Cleveland Star Yards LeGrange 3

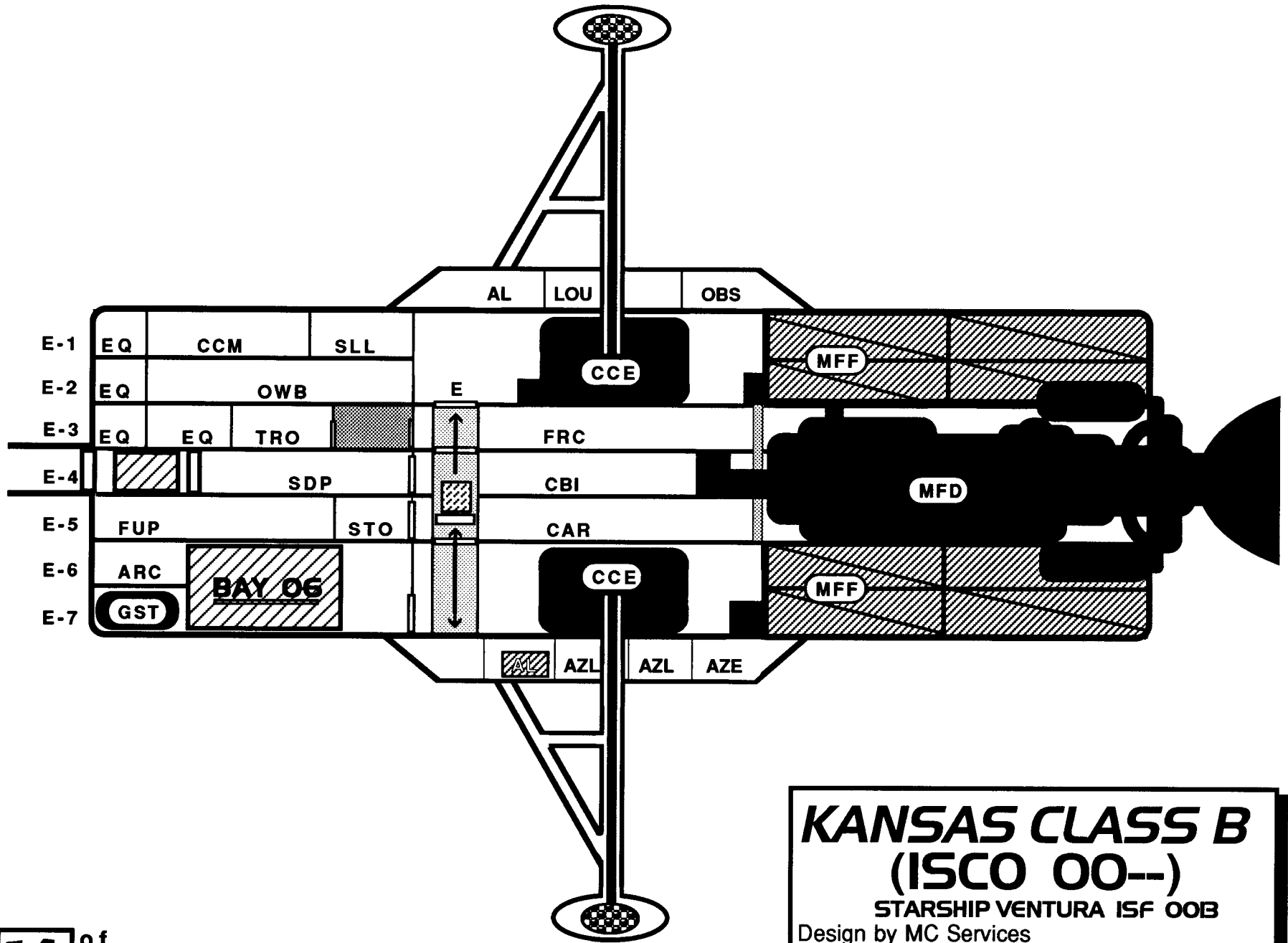

KANSAS CLASS B
(ISCO 00--)
 STARSHIP VENTURA ISF OOB
 Design by MC Services
 Cleveland Star Yards LeGrange 3

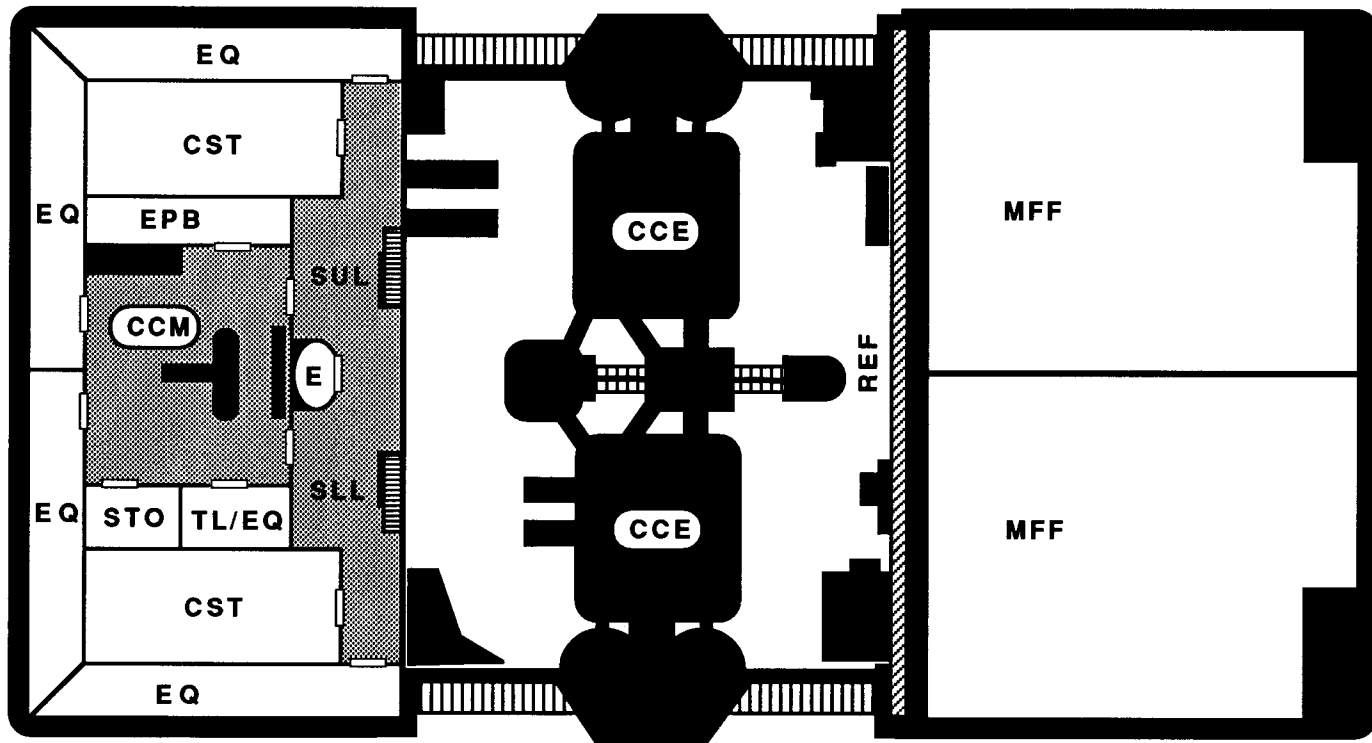

**KANSAS CLASS B
(ISCO 00--)**

STARSHIP VENTURA ISF 00B

Design by MC Services
Cleveland Star Yards LeGrange 3

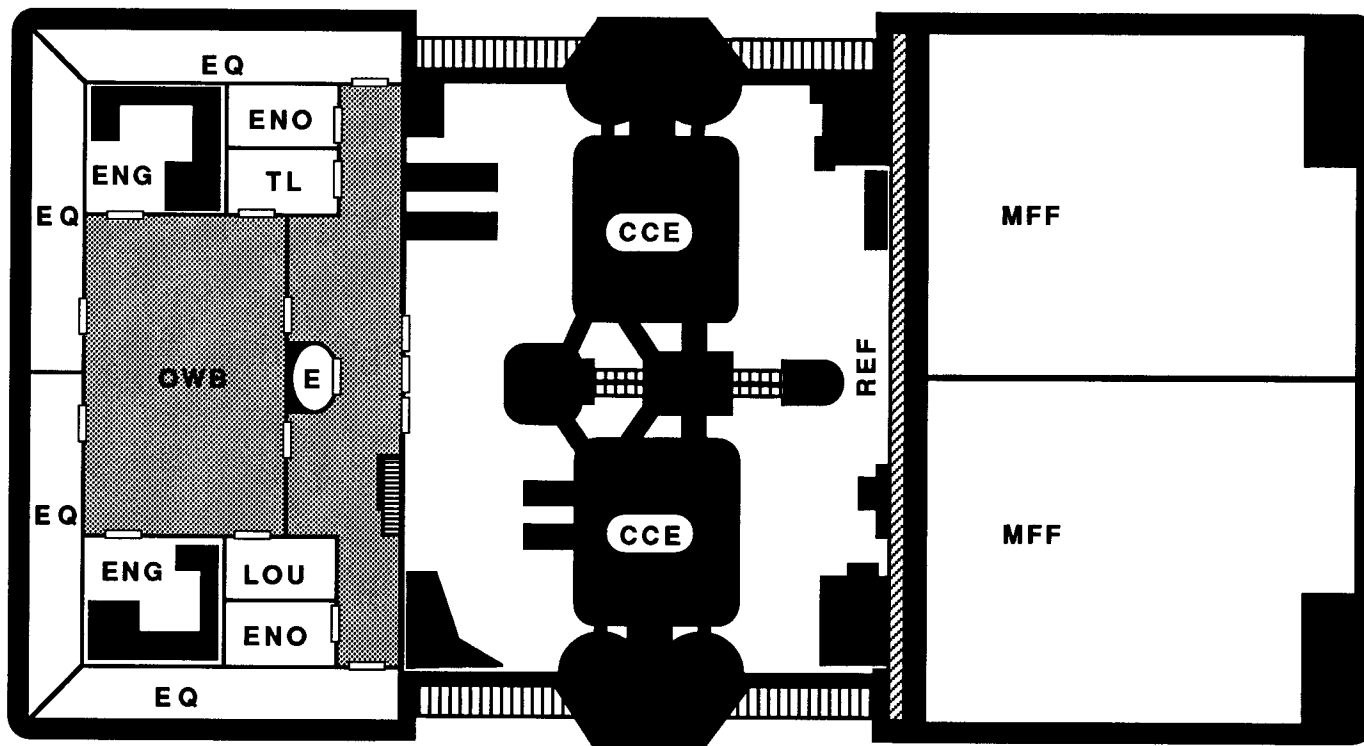

16 of
22 DECK E 2

KANSAS CLASS B
(ISCO 00--)

STARSHIP VENTURA ISF 00B

Design by MC Services
 Cleveland Star Yards LeGrange 3

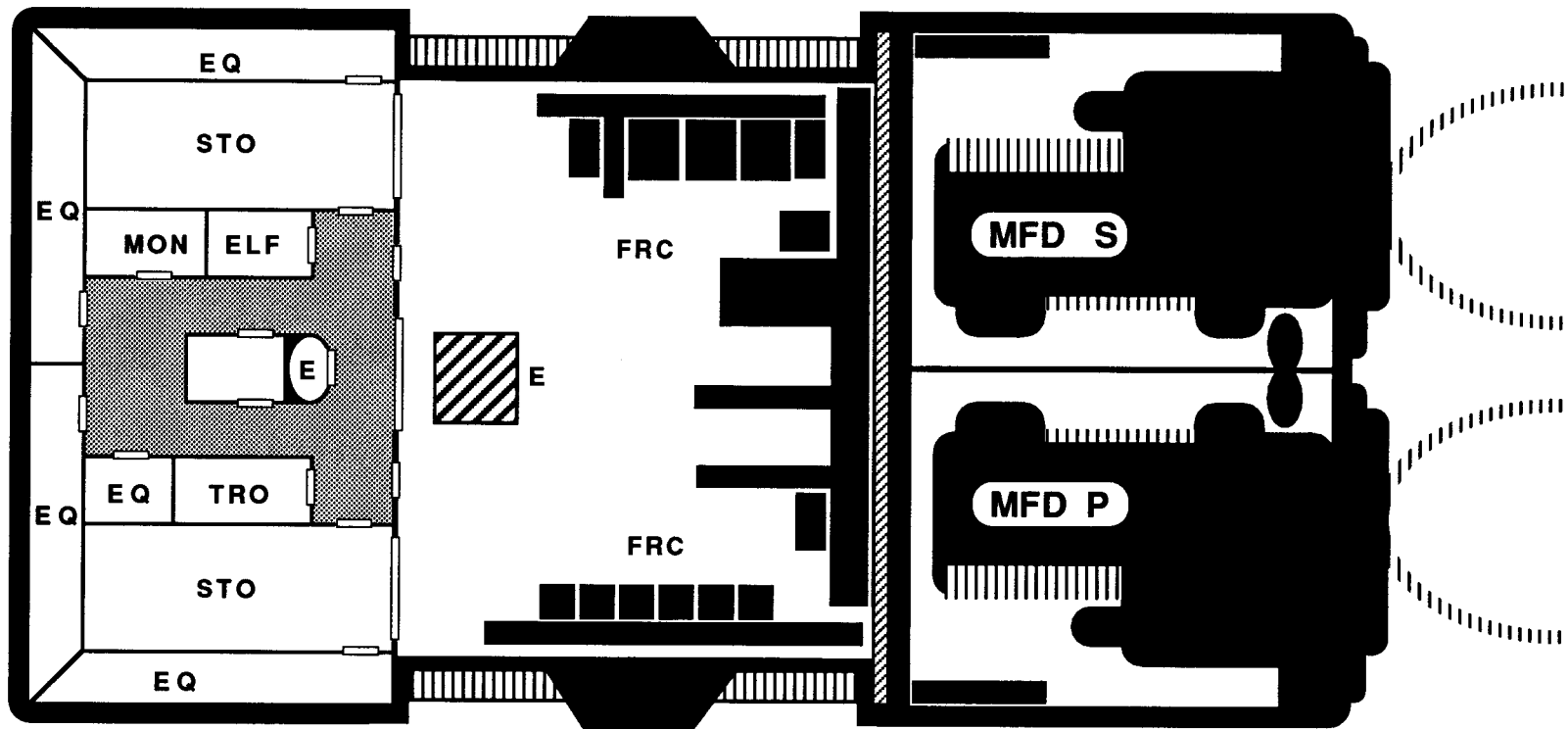

**KANSAS CLASS B
(ISCO 00--)**

STARSHIP VENTURA ISF 00B

Design by MC Services
Cleveland Star Yards LeGrange 3

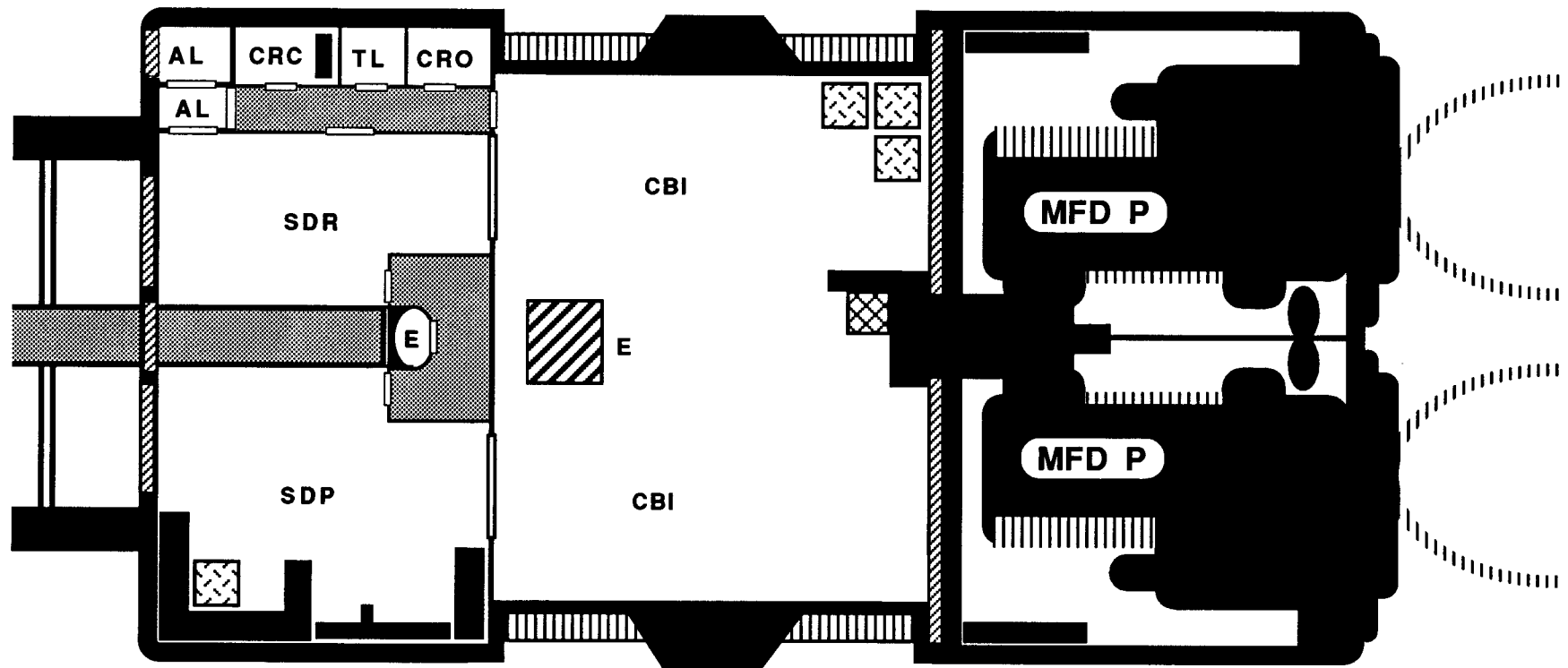

18 of
22 DECK E 4

**KANSAS CLASS B
 (ISCO 00--)**

STARSHIP VENTURA ISF 00B
 Design by MC Services
 Cleveland Star Yards LeGrange 3

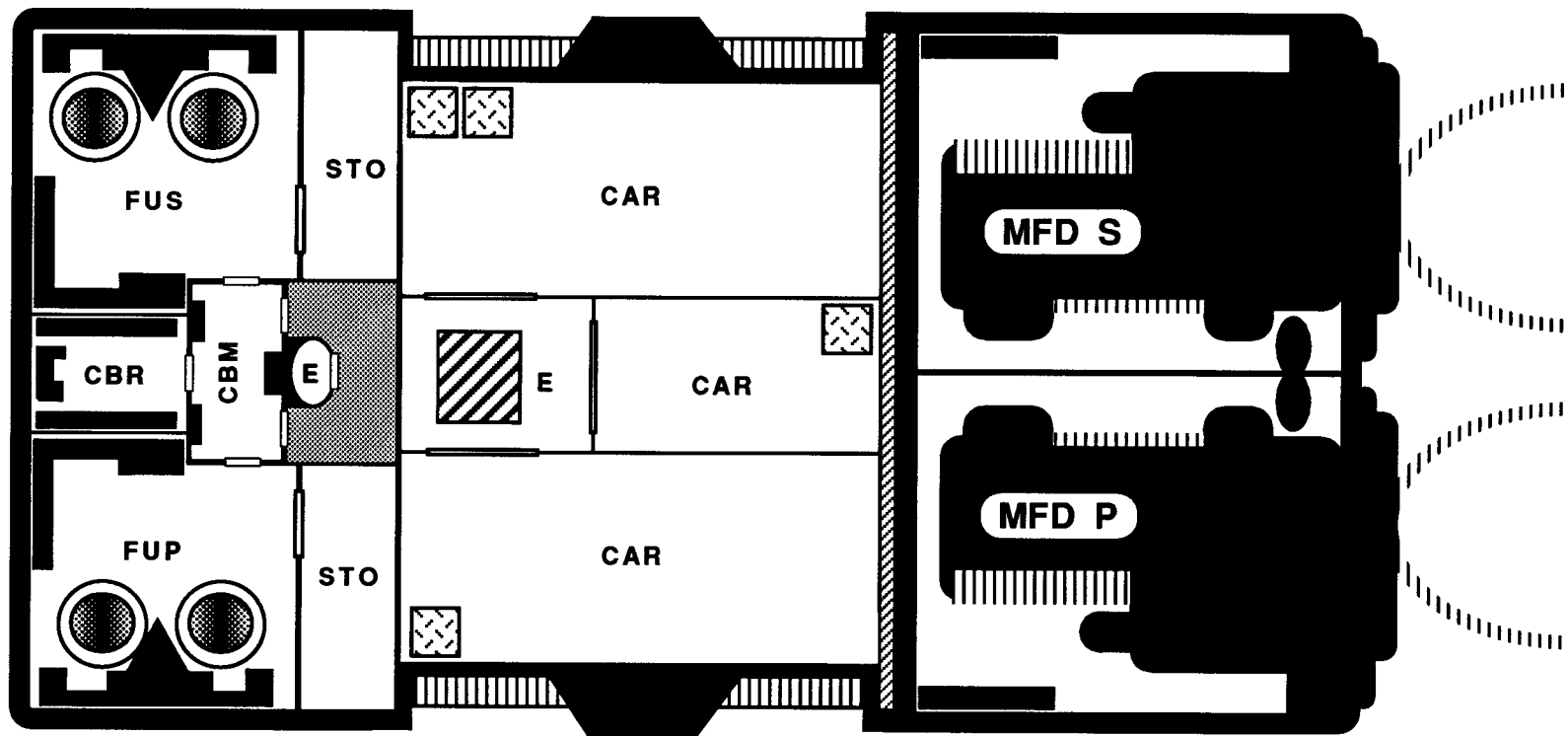

19 of
22 DECK E 5

**KANSAS CLASS B
(ISCO 00--)**

STARSHIP VENTURA ISF 00B

Design by MC Services
Cleveland Star Yards LeGrange 3

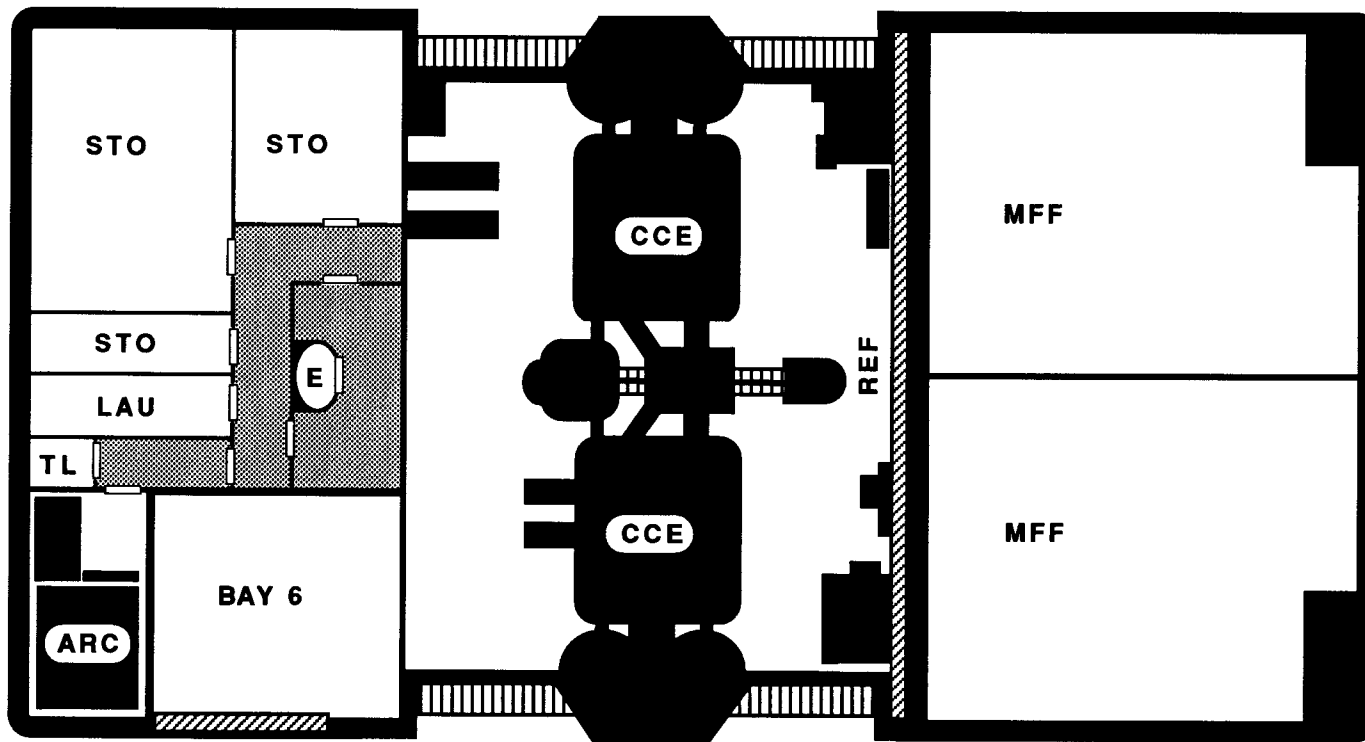

KANSAS CLASS B
(ISCO 00--)
 STARSHIP VENTURA ISF 00B
 Design by MC Services
 Cleveland Star Yards LeGrange 3

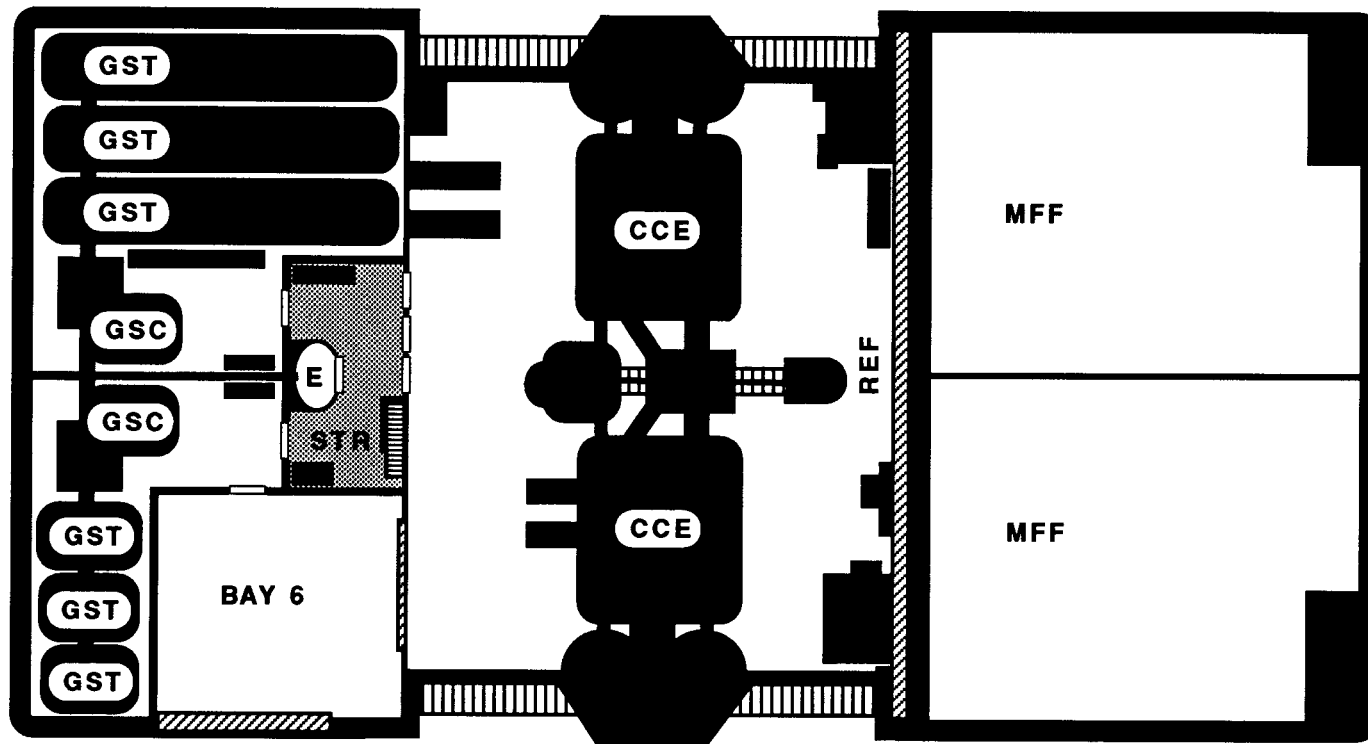

21 of
22 **DECK E 7**

**KANSAS CLASS B
(ISCO 00--)**

STARSHIP VENTURA ISF OOB

Design by MC Services
Cleveland Star Yards LeGrange 3

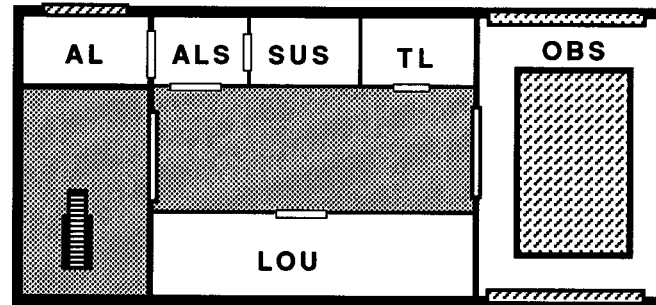

Upper Observation Deck

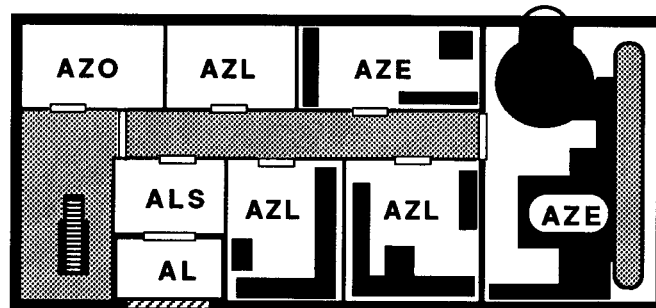

Lower Astro Research Deck

KANSAS CLASS B
(ISCO 00--)

STARSHIP VENTURA ISF 00B

Design by MC Services
 Cleveland Star Yards LeGrange 3