

2nd
Edition

Blood & Treasure

Fantasy Role Playing Game

Rulebook

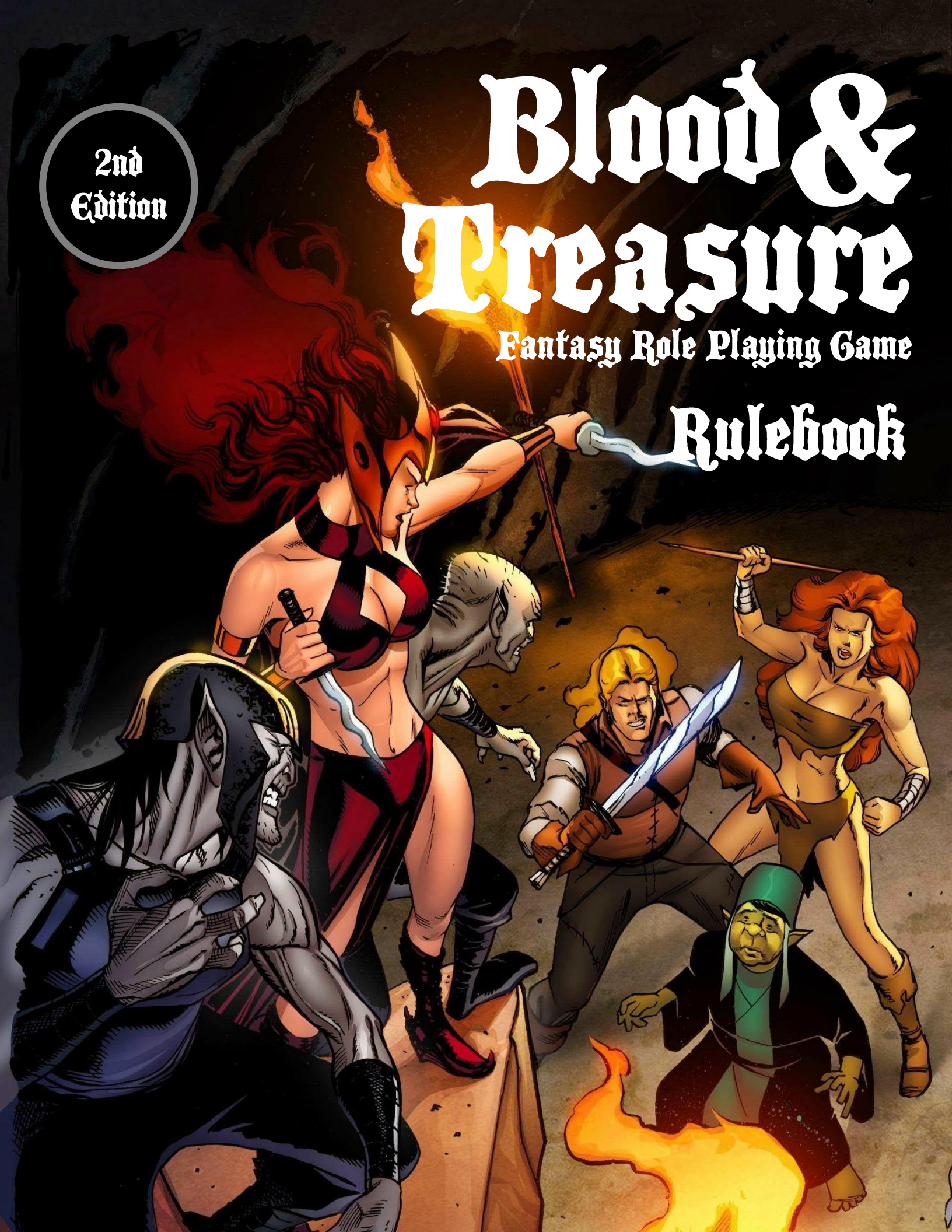

Blood & Treasure

Fantasy Role Playing Game



WRITTEN AND EDITED BY

John M. Stater

ADDITIONAL EDITING

Anthony Lewis
Tanner Yea

COVER ILLUSTRATION

David Williams

INTERIOR ILLUSTRATIONS BY

John Dickson Batten	Tazio Bettin
Wendelin Boeheim	Charles S Brooks
Luigi Castellani	Boris Dolgov
H. J. Ford	Jennie Harbour
Arthur Boyd Houghton	David Lewis Johnson
Jon Kaufman	J. Pingo Lindstrom
Indi Martin	Joyce Maureira
William McAusland	Denis McCarthy
Bradley K. McDevitt	Boutet de Monvel
Matt Morrow	Frank C. Pape
Dave Peterson	Joel Priddy
Howard Pyle	Arthur Rackham
Steve Robertson	Andrew Stout
	Jason Walton

Silhouettes by Telecanter

Cartography by Dyson Logos

1. Getting Started	1
2. Rolling Characters	2
3. Equipment	48
4. Rules of Play	61
5. Spells	81
6. Running a Game	158
7. Designing Dungeons	160
8. Designing Wilderness	170
9. Designing Settlements	173
10. Other Planes	181
11. Treasure	189

APPENDICES

A. Inspiration	248
B. Conversions	249
C. Racial Classes	251
D. Specialty Mages	256
E. Spell Components	257
F. Common Rolls and Useful Tables	258

INDEX	259
-------	-----

Blood & Treasure Second Edition Rulebook is Copyright 2016 John M. Stater

Some artwork copyright William McAusland, used with permission

Some artwork copyright Octavirate Entertainment, used with permission

Some artwork © STEVE ROBERTSON, used with permission

Some art by Denis McCarthy

Some images copyright Erisian Entertainment, used with permission

Gnome on page 254 by Indi Martin © 2015

Open Game License v 1.0 Copyright 2000, Wizards of the Coast, Inc.

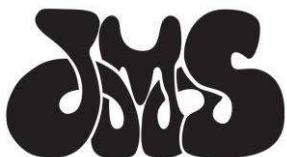

Getting Started

1

There is treasure under the earth, hidden in dank caverns and colossal vaults carved by the minions of wizards and dragons. Treasure enough to build a kingdom or destroy one, to launch a man or woman of lowly birth to the heights of power.

To get this treasure, you must leave the safety of hearth and home, cross wild and dangerous places and finally pierce the earth itself and delve deep into its mysteries. Most of the folk who seek this treasure die forgotten. A few carve out legends passed on by their lucky comrades. Fewer still live to tell their own tale and drag that treasure out of the underworld.

Will you be one of the lucky few?

The Basics

Blood & Treasure is a role playing game set in a fantasy world of dwarves, demons, dragons and hordes of gold coins and magic swords.

Blood & Treasure is a “pen & paper” game that requires a group of players to sit around a table with pencils, pieces of paper and dice and interact with one another to make things happen. One of the players is declared the referee, or Treasure Keeper and has the task of running the game. The other players take on the roles of fantasy characters – wizards, warriors, etc. – delving into dungeons in search of treasure. Most games have four to six players, but more or fewer players are possible.

The Dice

Dice are absolutely vital to a game of *Blood & Treasure*. The game consists of several people weaving a tale of adventure and exploration. In order to keep the game from being a series of arguments over whether or not the actions in the game are successful, dice are used to determine how the events of the tale unfold.

Blood & Treasure uses the six-sided dice most people are familiar with and several other types of dice that generate different ranges of numbers. These dice can be purchased on the internet or in most gaming stores.

Four-sided dice are abbreviated “d4”

Six-sided dice are abbreviated as “d6”

Eight-sided dice are abbreviated as “d8”

Ten-sided dice are abbreviated as “d10”

Twelve-sided dice are abbreviated as “d12”

Twenty-sided dice are abbreviated as “d20”

When the game calls for a certain dice to be rolled, it uses these abbreviations and precedes them with the number of dice to be rolled. If the game needs you to roll one twenty sided dice, it asks you to roll 1d20. If the game needs you to roll three six-sided dice, it asks you to roll 3d6.

There are three additional types of dice that are sometimes called for in the game. These dice do not technically exist, but other dice can be used to stand in for them on rolls.

Two-sided dice are abbreviated d2. A two sided dice can be simulated by flipping a coin (you must agree in advance whether heads or tails count as 1 or 2) or rolling a d6 and treating a roll of 1 to 3 as “1” and 4 to 6 as “2”.

Three-sided dice are abbreviated d3. A three sided dice can be simulated by rolling a d6 and treating a roll of 1 to 2 as “1”, a roll of 3 to 4 as “2” and a roll of 5 to 6 as “3”.

Percentile dice are abbreviated d100 or d%. To simulate a one hundred sided dice, roll two d10. The first dice counts as the ten’s place, the second as the one’s place. Thus, if the first dice was a “7” and the second dice was a “5”, the roll would be considered a “75”. If a “0” is rolled for the one’s place, it is counted as a “0”, thus “0” and “7” is 07, or just 7. A roll of “0” and “0” is “100”.

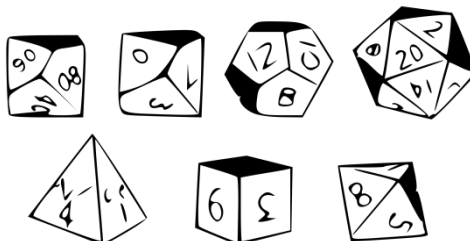

Rolling Characters

2

A player's character is their window to the fantasy world. Characters can be male or female, young or old, and one of several different races and classes.

Some aspects of a character are determined randomly, and are outside

the control of the player. Other aspects are determined by the player. Before you create a character, you need to understand the following terms.

Key Terms to Understand

Treasure Keeper: The referee for the game is referred to as the Treasure Keeper, which is abbreviated "TK".

Character: A character is a person or creature either controlled by a player (a "player character", or PC) or by the TK (a "non-player character", or NPC).

Ability Score: An ability score reflects a character's potency in six different measures, three physical and three mental. Determining these ability scores is the first step in creating a character.

Race: A character's race, human or demi-human, sets various benefits and limitations that have an impact on the character during play.

Class: A character's class is their profession. Class determines how good a character is at combat, whether they can cast magic spells and the tasks in which they are trained. After a character's ability scores are rolled and their race has been chosen, a class is chosen.

Alignment: A character's alignment is the philosophy they follow, Lawful, Neutral or Chaotic.

Experience Points: Experience points (XP) are a running measure of a character's deeds. XP are earned by overcoming challenges, such as monsters, puzzles and traps, and by claiming treasure.

Level: The more XP a character earns, the higher their class level. Just as an ability score measures strength or weakness, class level measures how accomplished one is at their chosen occupation. Most characters begin at 1st level, but some TK's might choose to start characters at higher levels to facilitate a different kind of game.

Hit Dice: A character earns a Hit Dice (HD) at each level. A HD is a dice rolled to determine a character's hit points (see below). The more skilled a class is at fighting, the larger their HD. Barbarians roll the largest, a d10, while magic-users and sorcerers roll the smallest, a d4.

Hit Points: Hit points (hp) are a measure of one's ability to survive danger. When hit points are reduced to 0, a character dies.

Attack Bonus: A character's attack bonus is the number they add to dice rolls when trying to deal damage to or overcome an opponent in combat.

Saving Throws: A saving throw is a dice roll made to escape or minimize a catastrophe.

Armor Class: A character's Armor Class (AC) is a target number that an attacker must meet or beat with their attack roll to inflict damage. Armor Class starts at 10 and increases due to a high dexterity score and armor.

Task Checks: Task checks are non-combat actions. A character that is skilled at a task gets better at it as they advance in level.

Feats: Feats are an optional set of special abilities that characters can learn as they advance in level. Feats permit characters to learn things not normally associated with their class, perfect different styles of fighting or learn new tricks with their spell casting.

Ability Scores

Each character is defined by six ability scores. These scores represent the character's mental and physical faculties and apply a bonus or penalty to the actions they attempt during play.

To generate ability scores, you can use one of the following methods or invent one of your own.

- 1) Roll 3d6 for each ability score, in order. You may then switch scores between two abilities.
- 2) Roll four six-sided dice for each ability score, in order, dropping the lowest value dice from each roll and adding the remaining dice together to get the score.
- 3) As above, but assign each score the ability you wish.

Each ability score, after modifications due to the character's race (see below), has a modifier ranging from -5 to +5. This modifier is the number you add to dice rolls when your character tries to do something

governed by that ability score. A positive modifier is a bonus and a negative modifier is a penalty.

Ability scores for non-player characters (NPC's) can be lower than 3 or higher than 18, but ability scores for new player characters must remain between 3 and 18.

Ability Modifiers

All ability scores provide a modifier that is used during play to a variety of actions. The modifier for each ability score is as follows:

Ability Score	Modifier
1	-5
2	-4
3	-3
4-5	-2
6-8	-1
9-12	0
13-15	+1
16-17	+2
18	+3
19	+4
20	+5

Strength (Str)

Strength measures muscle power. It is important for warriors because it helps them prevail in combat. Strength also determines how much weight you can carry before you are encumbered, the maximum weight you can lift over your head for a single round, and how far you can jump. The jump distance is for a standing long jump. For a running jump, double the distance, but you must run at least 30' before you jump. Divide these distances in half for small creatures, and multiple them by 1.5 for large creatures.

Strength also determines your chance to break down wooden doors. To break down standard wooden doors, you must roll your strength score or lower on 1d20. To break down iron doors or bend bars or lift gates and portcullises like Hercules, you have a percentage chance equal to your strength score.

Your strength modifier is applied to melee attack rolls, melee damage rolls, thrown weapon damage rolls, and some task checks.

Strength	Carrying Capacity	Maximum Lift	Jump
1	4 lb.	10 lb.	1'
2	7 lb.	20 lb.	2'
3	10 lb.	30 lb.	3'
4-5	20 lb.	45 lb.	4'
6-8	25 lb.	70 lb.	5'
9-12	40 lb.	110 lb.	6'
13-15	60 lb.	175 lb.	7'
16-17	80 lb.	250 lb.	8'
18	100 lb.	300 lb.	9'
19	120 lb.	350 lb.	10'
20	140 lb.	400 lb.	11'

Intelligence (Int)

Intelligence determines how well your character learns and reasons. This ability is important for magic-users because of their scholarly approach to magic. Animals have an intelligence score of 1 or 2. Sentient creatures have an intelligence score of 3 or higher.

Intelligence determines how many bonus languages a character knows and can speak. A high intelligence score also grants magic-users bonus spells per day.

Intelligence	Languages	Bonus Magic-User Spells per Day
1	0	-
2	0	-
3	0	-
4-5	0	-
6-8	+1	-
9-12	+2	-
13-15	+4	1st
16-17	+6	1st, 2nd
18	+7	1st, 2nd, 3rd
19	+8	1st, 2nd, 3rd, 4th
20	+9	1st, 2nd, 3rd, 4th, 5th

Wisdom (Wis)

Wisdom is common sense, willpower, perception and intuition. While the intelligence score represents one's ability to analyze and remember information, wisdom represents awareness of one's surroundings. Wisdom is the most important ability for clerics and druids, and it is also important for paladins and rangers.

You apply a wisdom modifier to saving throws vs. magic and to several tasks. A high wisdom score also grants clerics and druids bonus spells they can cast per day.

Wisdom	Bonus Cleric and Druid Spells per Day
1	-
2	-
3	-
4-5	-
6-8	-
9-12	-
13-15	1st
16-17	1st, 2nd
18	1st, 2nd, 3rd
19	1st, 2nd, 3rd, 4th
20	1st, 2nd, 3rd, 4th, 5th

Dexterity (Dex)

Dexterity measures hand-eye coordination, agility, reflexes and balance. This ability is most important for assassins and thieves, but also for characters that wear little or no armor, like duelists and monks.

You apply a dexterity modifier to ranged attack rolls, Armor Class, saving throws vs. breath weapons, rays and traps and several tasks.

Constitution (Con)

Constitution represents health, stamina and endurance. A constitution bonus increases a character's hit points, so it is important for all classes.

At each level, you add your constitution modifier to your hit point total. In the case of a penalty, means you get fewer hit points, though a character always gains a minimum of 1 hit point each time they advance in level. The constitution modifier is also added to saving throws against disease and poison.

Charisma (Cha)

Charisma measures force of personality, personal magnetism, ability to lead and physical attractiveness. This ability represents actual strength of personality, not merely how one is perceived by others in a social setting. Charisma is important for paladins, sorcerers, and bards.

Your charisma modifier affects whether monsters and NPCs you meet are hostile or friendly.

Charisma governs how many followers a character can have at one time in their employ. A high charisma score grants bards and sorcerers additional spells they can cast per day as intelligence does for magic-users.

Charisma	Followers	Bonus Bard and Sorcerer Spells per Day
1	0	-
2	0	-
3	1	-
4-5	2	-
6-8	4	-
9-12	6	-
13-15	8	1st
16-17	10	1st, 2nd
18	15	1st, 2nd, 3rd
19	20	1st, 2nd, 3rd, 4th
20	25	1st, 2nd, 3rd, 4th, 5th

Fantasy Races

Characters can be of one of seven different fantasy races. Each race has a unique perspective and different special abilities and limitations.

Humans

Humans should require no special introduction. They have a wide variety of body shapes, skin colors, hair colors, eye colors and cultures.

Humans average 66" in height and have a movement rate of 30' per round. They can live to be 110 years old. All humans start the game knowing Common, plus any bonus languages they wish for high intelligence.

Humans get a 10% bonus to all earned experience points. Thus, when a dwarf earns 100 XP, a human earns 110 XP. They also receive a bonus feat at 1st level or, if you do not use feats in your game, a +1 bonus to all of their saving throws to represent their uncanny luck.

Humans cannot multi-class (i.e. advance in two classes simultaneously), but they can dual-class, or change classes at any point during play (see below).





Dwarves

Dwarves are a stout, rugged people that dwell beneath the earth in mines or fortresses. They have craggy faces with large, sometimes bulbous, noses, bushy eyebrows and squinty eyes. For most dwarves, their beards are a matter of great pride. Dwarves tend to be loyal friends with a strong sense of right and wrong, but with a weakness for accumulating riches. Most dwarves are aligned with Law.

Dwarves average 48" tall. They have a movement rate of 20' per round. Dwarves live to be 450 years old. They start the game speaking Common and Dwarven plus bonus languages for high intelligence. Dwarves can see in the dark up to 60'.

At character creation, dwarves add +1 to constitution (max. of 18) and subtract 1 from charisma (min. of 3).

Dwarves enjoy a +3 bonus on saving throws against poison. They have a +3 bonus on saving throws against magic unless they are spell casters. Dwarf spell casters lose this bonus to save vs. magic.

When underground, dwarves note slanting and sloping passages, shifting walls, new construction and depth underground on a roll of 1-2 on 1d6.

Dwarves are +1 to attack goblins, hobgoblins and orcs, and have a +4 bonus to Armor Class against giants.

Dwarf fighters can multi-class as clerics or thieves.

Elves

Elves are graceful creatures descended from the fey. They have fine features, ears that come to an attractive point and vivid eyes. Their skin and hair color are often in harmony with the environment they call home, thus desert elves might have skin the color of sand and hair the color of a desert sunset.

Elves average 60" in height. They have a movement rate of 40' per round. Elves live to be 750 years old. They start the game speaking Common and Elven plus bonus languages for high intelligence. Elves can see in the dark to a range of 60'.

At character creation, elves add +1 to dexterity (max. of 18) and subtract 1 from constitution (min. of 3).

Elves have magic resistance 90% against sleep and charm, and they are immune to the paralyzing touch of ghouls. They enjoy a +2 bonus to task checks to move silently and find secret doors on a roll of 1-2 on 1d6.

LANGUAGES

Virtually every humanoid and giant species in the game has its own language, as do many monsters. The language called Common represents something akin to Latin in Medieval Europe – it is a trade tongue common to many species.

Other languages in the game include:

Celestial	Dragon	Druidic
Dwarf	Elemental*	Elf
Giant *	Gnoll	Gnome
Grimlock	Goblin**	Halfling
Infernal	Kobold	Manticore
Medusa	Naga	Ogre
Ophidian	Orc	Sylvan***

* Each type has its own dialect

** Spoken by goblins, hobgoblins, bugbear and their kin

*** Spoken by the fey

Elves are +1 to attack with longbows, short bows, long swords and short swords.

Elf magic-users can multi-class as clerics, fighters or thieves, and truly extraordinary elves can multi-class as fighter/magic-user/thieves.

Gnomes

Gnomes are fairy creatures who stand about 2 to 3 feet tall. In most ways, they appear to be miniature dwarves, though they do not share the stern attitudes of those people. Gnomes have an infectious sense of wonder and curiosity and a love of jests and jokes.

Gnomes average 28" in height. They have a movement rate of 20' per round. Gnomes live to be 275 years old. They start the game speaking Common and Gnome plus bonus languages for high intelligence. They can also speak to all burrowing mammals. Gnomes can see in the dark to a range of 60 feet.

At character creation, gnomes add +1 to constitution (max. of 18) and subtract 1 from strength (min. of 3).

Gnomes enjoy a +1 bonus to attack goblins and kobolds, and enjoy a +4 bonus to AC against giants.

When underground, gnomes note sloping passages, unsafe construction, approximate depth underground and direction of travel on a roll of 1-2 on 1d6.

Gnomes have a natural affinity for illusions. A gnome with a charisma score of 10 or higher can cast the following spells, each once per day: *Audible glamor*, *dancing lights* and *prestidigitation*. Gnomes have a +2 bonus on saving throws vs. illusions.

Gnome illusionists (a form of magic-user, see below for more information) can multi-class as clerics, fighters or thieves. Gnome thieves can multi-class as fighters.

Half-Elves

Half-elves are the children of humans and elves. They look like pretty, graceful humans. Humans consider half-elves flighty and inconstant and elves think them too practical and grounded, but they still like them.

Half-elves average 62" in height. They have a movement rate of 30' per round. Half-elves live to be 185 years old. They start the game speaking Common and Elven plus bonus languages for high intelligence. Half-elves can see 60' in the dark.

Half-elves have 30% magic resistance to sleep and charm. Their good looks and pleasant manners give them a +1 reaction bonus.

Half-elves can multi-class as do elves at 1st level, or if they do not multi-class, can dual-class as humans.

Half-Orcs

Half-orcs are the issue of humans and the monstrous orcs. They look like brutish humans with pug noses and large canine teeth, and are cunning and ill-tempered.

Half-orcs average 72" in height. They have a movement rate of 30' per round. Half-orcs live to be 80 years old. They start the game speaking Common and Orc plus bonus languages for high intelligence. They can see 60' in the dark.

At character creation, half-orcs add +1 to strength and constitution (max. of 18) and subtract 2 from their starting charisma (min. of 3).

Half-orc assassins and thieves can multi-class as clerics, fighters or magic-users. A half-orc that does not choose to multi-class at 1st level can instead dual-class.

Halflings

Halflings are small folk with big appetites. When young, they are slender and possess an unquenchable curiosity. As they age they have a tendency to become staid, settled and portly – comfortable, one might say.

Halflings average 36" in height. They have a movement rate of 20' per round. They live to be 200 years old. Halflings start the game speaking Common and Halfling plus bonus languages for high intelligence. Halflings can see 30' in the dark.

At character creation, halflings add +1 to dexterity (max. of 18) and subtract 1 from strength (min. of 3).

Halflings enjoy a +1 bonus to attack when attacking with slings and thrown weapons. They surprise on a roll of 1-3 on 1d6 when alone and not wearing metal armor. Halflings have a +3 bonus to save vs. poison and magic. Halfling spell casters lose their bonus to save vs. magic.

Halfling thieves can multi-class as clerics or fighters. Halfling fighters can multi-class as clerics or druids.

Other Fantasy Races

Several of the monsters in *Blood & Treasure* are given statistics to make them playable races, but check with your Treasure Keeper to make sure he or she is allowing them in their game before you decide to play one.

Racial Height, Weight and Age

Race	Avg. Height	Avg. Weight	Starting Age	Mature Age	Old Age
Dwarf	48"	165 lb.	45-50	188	300
Elf	60"	120 lb.	120-130	250	550
Gnome	28"	40 lb.	60-65	150	200
Half-elf	62"	125 lb.	20-25	90	125
Half-orc	72"	190 lb.	15-20	45	60
Halfling	36"	35 lb.	30-35	75	150
Human	66"	185 lb.	18-20	50	70

When a character reaches mature age, strength, dexterity and constitution are all reduced by 1 point.

When a character reaches old age, strength, dexterity and constitution are all reduced by 2 more points. The character's wisdom score is reduced by 1 point due to poor hearing and sight, and there is a 50% chance that the character's intelligence is also reduced by 2 points due to faulty memory.

Character Classes

A character class is a character's occupation. Players may choose from thirteen classes for their character. Some character classes have ability score requirements for entry, and place restrictions on a character's alignment and the armor and weapons they may use.

Do not think that a character class is set in stone. Feel free to introduce variations, either to improve a class, make it more suitable for your campaign, or even to please a player. Sample variations are included with each class to show how this is done.

Advancing in Level

Characters earn experience points (XP) in three ways: Killing monsters (each is worth XP based on how dangerous it is, see the *Monsters* book for more), overcoming challenges (with rewards determined by the TK) and acquiring treasure (earning one XP per gold piece of value of the treasure).

A character's level is determined by how many XP he has accumulated. Each character class advances in level at a different rate. You will find more information on how many XP a character needs to advance in level under each class description below.

When a character advances in level they roll a new Hit Dice to gain hit points unless they are 11th level or higher, in which case they gain a set number of hit points per level. Their attack bonus and saving throw may improve and they may gain new special abilities or improve the special abilities they already have. If your TK is using feats in her game, the adventurer may also gain a new feat.

Access to Classes

The TK determines which classes are open to players in his campaign. The most basic classes are the Cleric, Fighter, Magic-User and Thief. These classes are almost always open to the players. The advanced classes of Assassin, Barbarian, Bard, Druid, Duelist, Monk, Paladin, Ranger and Sorcerer may not be available.

In addition, the TK decides which, if any, class variations players may choose from, including whether they may play specialist priests and mages or choose a bloodline for their sorcerer.

Access to Spells

Spells are divided between basic spells and advanced spells. While basic spells are usually available in all campaigns, except perhaps for special reasons tied to the nature of the campaign, advanced spells are only available if the TK wants them in her campaign.

Class Requirements and Restrictions

Class	Abilities	AL	Armor	Weapons
Assassin	S9 I9 D13	C	Limited	All
Barbarian	S15 D13 Cn13	Any	Limited	All
Bard	S9 I9 Ch13	N	Limited	All
Cleric	W9	L/C	All	Limited
Druid	W13 Ch15	N	Limited	Limited
Duelist	S9 I9 D15	Any	Limited	All
Fighter	S9	Any	All	All
Magic-user	I9	Any	None	Limited
Monk	S12 W13 D15	Any	None	All
Paladin	S9 Ch15	L	All	All
Ranger	S9 W13 Cn15	L	All	All
Sorcerer	Ch9	Any	None	Limited
Thief	D9	N/C	Limited	Limited

Class Abilities

Class	HD	Special Abilities
Assassin	d6	Skills, backstab, death attack, poison use
Barbarian	d10	Skills, increased movement, alertness, rage
Bard	d6	Skills, spells, fascinate, suggestion, break enchantments
Cleric	d6	Spells, turn undead
Druid	d6	Spells, shapechange, immunities, sacrifice
Duelist	d8	Weapon specialization, parry, riposte, roll with lethal blow
Fighter	d8	Multiple attacks, wondrous mounts
Magic-user	d4	Spells, arcane knowledge
Monk	d6	Skills, unarmed combat, many immunities, quivering palm
Paladin	d8	Detect evil, smite evil, protect from evil, lay on hands, special mount, spells
Ranger	d8	Skills, alertness, hunting beast, increased damage vs. humanoids and giants, spells
Sorcerer	d4	Spells, sense vibrations, impromptu casting
Thief	d6	Skills, backstab, assemble rogues

The Assassin

Assassins slink through the shadows, eyes ever alert for an opportunity to strike a killing blow. Assassins are rarely psychopaths – they are professionals, using their skills only when they're paid to do so or advancing some other agenda. They are employed as spies as well as hired killers, and in this capacity often rub elbows with the finer elements of society. At heart, each seeks the peace that can only be gained in their dangerous world by building a fanatically loyal body of followers with which they can surround themselves. To do this, they need wealth, the kind of wealth that lies buried beneath the ground, in labyrinthine dungeons guarded by monsters more terrifying than the assassin.

Requirements & Restrictions

To become an assassin, a character must have the following minimum scores: Str 9, Int 9 and Dex 13.

Assassins must be Chaotic in alignment.

They can wear leather armors and use any type of shield. They can wield any weapon in combat.

Assassin Skills

Assassins add their level to the following task checks:

Climb Walls—Assassins can climb walls and other sheer surfaces without climbing gear at a rate of 10' per round.

Disguise—Assassins are masters of disguise. They suffer a -1 penalty to their task check if they are disguised as the opposite sex, or as creature of a different size (such as a halfling or gnome disguised as a human).

Forgery—Assassins can make forgeries of documents, provided they are literate in the document's language.

Hear Noise—Assassins can hear incredibly quiet noises through doors or from far away.

Hide in Shadows—Assassins can disappear into the shadows and remain unseen, even while moving. An assassin can backstab from the shadows.

Move Silently—Assassins can walk slowly without making a sound if they are not in metal armor.

Open Locks—Assassins can use a set of thieves' tools to open locks.

Read Languages—Assassins can decipher languages that are unknown to them. After 6th level, an assassin can use this ability to cast spells from a magic-user scroll.



Assassin Abilities

Assassins have the backstab ability of thieves, though more deadly. When a 5th level assassin surprises a victim and successfully backstabs them, the victim must pass a saving throw vs. death or either be paralyzed for 1 round per assassin level or killed outright (player's choice). If the saving throw succeeds, the victim still suffers normal backstab damage.

Assassins are trained in the use of poison and never risk accidentally poisoning themselves when applying poison to a blade, pouring it into a goblet, etc. Any city's guild of alchemists knows that only members of the local order of assassins are permitted to buy poisons more powerful than Type I. They report attempts to do so to the assassins, who take these incursions on their monopoly very seriously.

Assassins also learn how to brew poisons of their own. At second level, an assassin learns to brew an ingestible version of Type I poison, which causes sleep. As the assassin advances in level, he learns to concoct more powerful poisons, and to concoct poisons that are delivered in other ways, such as contact poisons, poisons with delayed effects, powders and gasses.

Assassin Class Advancement Table

Level	Experience Points	Hit Dice	Attack Bonus	Saving Throw	Backstab	Title
1st	0	1d6	+0	16	1d6	Ruffian
2nd	1,750	2d6	+1	16	1d6	Marauder
3rd	3,500	3d6	+1	15	1d6	Thug
4th	7,000	4d6	+2	15	1d6	Blackguard
5th	14,000	5d6	+2	15	2d6	Cut-throat
6th	28,000	6d6	+3	15	2d6	Hellhound
7th	56,000	7d6	+4	14	2d6	Malefactor
8th	110,000	8d6	+4	14	2d6	Slayer
9th	220,000	9d6	+5	14	3d6	Death Lord
10th	330,000	10d6	+5	14	3d6	Death Lord
11th	440,000	+2 hp	+6	14	3d6	Death Lord
12th	550,000	+2 hp	+7	13	3d6	Death Lord
13th	660,000	+2 hp	+7	13	4d6	Death Lord
14th	770,000	+2 hp	+8	13	4d6	Death Lord
15th	880,000	+2 hp	+8	13	4d6	Death Lord
16th	990,000	+2 hp	+9	12	4d6	Death Lord
17th	1,100,000	+2 hp	+10	12	4d6	Death Lord
18th	1,210,000	+2 hp	+10	12	4d6	Death Lord
19th	1,320,000	+2 hp	+11	12	4d6	Death Lord
20th	1,430,000	+2 hp	+11	12	4d6	Death Lord

Level	Poison	Cost
2nd	Type I poison	10 gp
3rd	Contact poisons	x2
4th	Type II poison	50 gp
5th	Delayed poisons	x3
6th	Type III poison	100 gp
7th	Powders	x4
8th	Type IV poison	150 gp
9th	Poison gas	x5

A 1st level assassin can make ingested poisons. A 3rd level assassin learns to make contact poisons that can be applied to weapons. A 5th level assassin can make slow-acting poisons. The effects of this poison can be delayed for up to 1 hour per assassin level. A 7th level assassin can make powders. A 9th level assassin can make poison gas, which can fill a 10' x 10' x 10' area.

An assassin can brew one dose of poison per day of work.

Assassin Orders

A 9th level assassin may found his own order of assassins if he can conquer a mountain stronghold by means of terror, skullduggery and assassination, and if

there is not already an assassin order in the area. If there is, he must kill the leader of this order in open combat to seize power, or assassinate him or her to make room for their new order of assassins. The leader of the existing order's level is 1d12+8.

Possible Variation

Bounty hunters replace the assassin's Chaotic alignment, use and brewing of poison and death attack with the Neutral alignment, the monk's stunning attack and the ranger's tracking skill. High level bounty hunters retire with their wealth to some place far away where they are not known and where they have no enemies of which they know. They can use their wealth to build a manor and hire retainers to help them defend it.



The Barbarian

Barbarians are savage, uncouth warriors from beyond the bounds of civilization. Raised in the wild, they exhibit an animal prowess at combat and survival. They venture into the lands of civilized men to make their fortunes and their reputations that they might one day found a horde or tribe of their own.

Requirements & Restrictions

To become a barbarian, a character must have the following minimum scores: Str 15, Dex 13 and Con 13.

Barbarians may not be Lawful in alignment, though they can choose to be either Neutral or Chaotic.

They can use leather and mail armors and all shields. Barbarians can fight with any weapon.

Barbarians can use magic armor and weapons, but not other magic items.

Barbarian Skills

Barbarians add their level to the following task checks:

Climb Walls—Barbarians can climb walls and scale cliffs without climbing gear at a rate of 10' per round.

Hear Noise—Barbarians can hear incredibly quiet noises through doors or from far away.

Hide in Shadows—Barbarians can disappear into the shadows and remain unseen, even while moving.

Move Silently—Barbarians can walk slowly without making a sound if they are not in metal armor.

Survival—Barbarians have the same ability to survive in the wilderness as a ranger.

Tracking—Barbarians can track in the wilderness, but not dungeons, as a ranger.

Barbarian Abilities

A barbarian's land movement rate is increased by 10 feet. In addition, they can run for twice as long as other classes.

Barbarians are only surprised on a roll of 1 on 1d6. Her foes gain no bonus to attack her due to flanking, rear attacks or attacks while invisible.



A barbarian can fly into a rage during combat once per day per four levels. While raging, a barbarian makes two attacks per round and she is immune to fear and mind-affecting and holding spells.

A raging barbarian cannot do anything that requires much thought or concentration. They cannot cast spells, make or follow plans, seek cover or make ranged attacks other than throwing weapons, they must fight opponents until one or the other dies (no retreat) and when they kill an opponent they must attack the next nearest opponent.

A barbarian's rage lasts for 6 rounds, and a barbarian may end her rage whenever she wishes. At the end of her rage, a barbarian is fatigued (see Rules of Play: Conditions) until they rest for one hour.

Hillfort

A 9th level barbarian can build a hill fort. When she does, she gains 100 barbaric warriors and non-combatants equal to 5 times the warriors to populate their nascent kingdom. She also gains 1d6 first level barbarians who wish to join her campaigns of plunder and one 3rd level barbarian to serve as her sub-chief.

Barbarian Class Advancement Table

Level	Experience Points	Hit Dice	Attack Bonus	Saving Throw	Rage	Title
1st	0	1d10	+1	16	1/day	Tribesman
2nd	2,200	2d10	+2	15	1/day	Savage
3rd	4,400	3d10	+3	15	1/day	Plunderer
4th	8,800	4d10	+3	14	2/day	Raider
5th	17,600	5d10	+4	14	2/day	Reaver
6th	35,200	6d10	+5	13	2/day	Shield-biter
7th	70,400	7d10	+6	13	3/day	Berserker
8th	140,000	8d10	+6	12	3/day	Conqueror
9th	280,000	9d10	+7	12	3/day	Barbarian Prince/ss
10th	420,000	+3 hp	+8	11	4/day	Barbarian Prince/ss
11th	560,000	+3 hp	+9	11	4/day	Barbarian Prince/ss
12th	700,000	+3 hp	+9	10	4/day	Barbarian Prince/ss
13th	840,000	+3 hp	+10	10	5/day	Barbarian Prince/ss
14th	980,000	+3 hp	+11	9	5/day	Barbarian Prince/ss
15th	1,120,000	+3 hp	+12	9	5/day	Barbarian Prince/ss
16th	1,260,000	+3 hp	+12	8	6/day	Barbarian Prince/ss
17th	1,400,000	+3 hp	+13	8	6/day	Barbarian Prince/ss
18th	1,540,000	+3 hp	+14	7	6/day	Barbarian Prince/ss
19th	1,680,000	+3 hp	+15	7	6/day	Barbarian Prince/ss
20th	1,820,000	+3 hp	+15	7	6/day	Barbarian Prince/ss

Barbarian Horde

At 12th level or after, a barbarian may summon a horde. She must send out riders with gifts and wait one month to see who answers her call to conquest and pillage.

After one month, the barbarian rolls a number of times equal to their level on the following table to discover who answers her call to raid and plunder.

The size of the dice used for these rolls depends on the amount of money that was spent on gifts, as follows:

Value of Gifts	Dice Size
10,000 to 20,000 gp	d6
21,000 to 35,000 gp	d8
36,000 to 50,000 gp	d10
51,000 to 80,000 gp	d12
81,000 gp or more	d20

Each month, a unit has a 25% chance of abandoning the horde and going back home. This chance is reduced by 5% for each victory they have won, but it is increased by 5% for each loss. A unit that has lost more than half its strength increases its chance of leaving by +10%.

Roll	Unit Attracted	Roll	Unit Attracted
1	None	11	30 bugbears
2	100 warriors	12	30 centaurs
3	80 bandits	13	10 ogres
4	50 red amazons	14	6 hill giants
5	80 nomads	15	6 trolls
6	50 berserkers	16	6 werewolves
7	150 goblins	17	6 pteranodon riders
8	100 orcs	18	1 druid (1d4+4 for level)
9	80 hobgoblins	19	1 war mammoth and crew
10	50 gnolls	20	1 chromatic dragon

Barbarians may only call a horde once in their lives.

Possible Variation

Beastmasters replace the barbarian's rage with the ability to turn/command animals the way a cleric turn/commands the undead. They lose the use of armor, but gain the ability to cast *summon nature's ally* once per day as though they were a druid of the same level, thus *summon nature's ally I* at 1st level, *II* at 3rd, *III* at 5th, *IV* at 7th, and so on.

The Bard

The bard specializes in musical performance and the art of persuasion. Bards are middling warriors, have many useful skills and they are capable of some spell casting, specializing in enchantments and illusions.

Requirements & Restrictions

To become a bard, a character must have the following minimum scores: Str 9, Int 9 and Cha 13.

Bards must be Neutral in alignment. They can use leather and mail armors and may use any weapon in combat.

Bard Skills

Bards add their level to the following task checks.

Carouse—Bards can carouse in taverns to learn valuable information. With a successful task check, a bard learns 1d6 rumors about the settlement and its surrounding region. If the task check fails, check on the table below:

Fails by ...	Consequence
1	Fatigued
2-3	Fatigued, plus robbed of possessions
4	Fatigued, robbed of possessions, and 1d6+1 damage
5-9	Wakes up with a stranger (15% chance married)
10-14	Made a powerful local enemy
15+	Wakes up in stocks (1d6 days)

Lore—Bards can recall lore about magic items and monsters. A successful check reveals an item's powers and gives a clue to its command word, or reveals a monster's vulnerabilities.

Read Languages—Bards can read languages that are unknown to them.

Bards add half their level to the following task checks:

Climb Walls—Bards can climb walls without climbing gear at a rate of 10' per round.

Hear Noise—Bards can hear incredibly quiet noises through doors or from far away.

Hide in Shadows—Bards can disappear into the shadows and remain unseen, even while moving.

Move Silently—Bards can walk slowly without making a sound if they are not in metal armor.



Open Locks—Bards can use thieves' tools to open locks.

Pick Pockets—Bards can pick pockets and perform small acts of legerdemain.

Bard Abilities

A bard casts spells from the magic-user spell list using the same rules as a magic-user. A bard can only cast basic spells, not advanced. He begins play knowing four 1st level spells and learns one new spell at each level, as well as through spell research, being taught by other bards or by finding spells in treasure troves.

Once per day per bard level, a bard can use his musical ability to produce magical effects on those around him.

A bard can use his music to cause sentient creatures within earshot to become *fascinated* with him. A bard can fascinate a number of creatures equal to his Charisma score. Fascinated creatures sit quietly and listen to the bard, taking no other actions for as long as the bard continues to play. Threats and loud noises break the effect. A bard can also use his musical ability to cancel the musical attacks of monsters like harpies and sirens, and of some magic items, like *pipes of the sewer*. In a bard's hands, a musical magic item has double the normal range and double the normal effects.

A 6th level bard can make a *suggestion* (as the spell) to a single creature that he has already *fascinated* with no additional save permitted.

Bard Class Advancement Table

Level	Experience	Hit	Attack	Saving	Title	Spells per Day per Spell Level					
	Points	Dice	Bonus	Throw		1st	2nd	3rd	4th	5th	6th
1st	0	1d6	+0	16	Rhymer	1	-	-	-	-	-
2nd	2,100	2d6	+1	16	Scop	2	-	-	-	-	-
3rd	4,200	3d6	+1	15	Jongleur	3	-	-	-	-	-
4th	8,400	4d6	+2	15	Versifier	4	1	-	-	-	-
5th	16,800	5d6	+2	15	Goliard	4	2	-	-	-	-
6th	33,600	6d6	+3	15	Poet	4	3	1	-	-	-
7th	67,200	7d6	+4	14	Minstrel	4	3	2	-	-	-
8th	130,000	8d6	+4	14	Skald	4	3	2	-	-	-
9th	260,000	9d6	+5	14	Bard	4	3	3	1	-	-
10th	390,000	10d6	+5	14	Bard	4	3	3	2	-	-
11th	520,000	+2 hp	+6	14	Bard	4	3	3	2	-	-
12th	650,000	+2 hp	+7	13	Bard	4	3	3	3	1	-
13th	780,000	+2 hp	+7	13	Bard	4	3	3	3	2	-
14th	910,000	+2 hp	+8	13	Bard	4	3	3	3	2	-
15th	1,040,000	+2 hp	+8	13	Bard	5	3	3	3	3	1
16th	1,170,000	+2 hp	+9	12	Bard	5	4	3	3	3	2
17th	1,300,000	+2 hp	+10	12	Bard	5	4	4	3	3	3
18th	1,430,000	+2 hp	+10	12	Bard	5	4	4	4	3	3
19th	1,560,000	+2 hp	+11	12	Bard	5	4	4	4	4	3
20th	1,690,000	+2 hp	+11	12	Bard	5	4	4	4	4	4

A 12th level bard can use his music to create an effect equal to the *break enchantment* spell. This affects one creature within 30 feet, and takes one minute.

Bard Followers

Bards are wanderers, who do not build strongholds or stay too long in one place if they can help it. Instead, bards gain random followers beginning at 6th level and gain one follower per level until 12th level. Followers that are lost are not regained.

d%	Follower
01-12	3 brigands (studded leather, longbow, dagger)
13-16	3 rakes (warriors, leather, buckler, rapier, dagger)
17-46	Bard (roll 1d3 for level)
47-56	Druid (1st level)
57-81	Fighter (1st level)
82-84	Fighter/magic-user (1st level)
85-87	Fighter/thief (1st level)
88-92	Magic-user (1st level)
93-99	Thief (1st level, may be alternate scout class)
00	Extraordinary follower

d%	Extraordinary Follower
01-30	Black bear
31-38	Grig
39-48	Blink dog
49-73	Raven
74-79	Gnome illusionist (1d3 for level)
80-85	Elf enchanter (1d3 for level)
86-00	Satyr

Possible Variation

Jesters replace the bard's use of armor and shields and ability to fascinate with the monk's AC bonuses and reduced falling damage, and the duelist's taunt skill.



The Cleric

Clerics are men and women who have been touched by the divine. They have received wisdom from beyond, and have been tasked by a deity or deities to spread word of their power and glory far and wide.

Each cleric is the priest of a heretofore unknown god or goddess, tasked with spreading their worship. They start with a wooden holy symbol and a dream, and they aim to one day build a great temple to their deity.

Lawful clerics worship deities dedicated to furthering civilization and enlightenment. They are givers of hope to the hopeless, succor to the ill, defenders of the weak, and destroyers of the unholy.

Chaotic anti-clerics, on the other hand, adhere to a creed of sin, degeneracy, greed and corruption. The anti-cleric cannot give succor and would not if he could. Anti-clerics consort with the powers of darkness, and work to undermine the foundations of civilization either to remake it in the image of their dark deity, or just for the pleasure of seeing it all burn.

Requirements & Restrictions

To become a cleric, a character must have a wisdom score of 9 or higher. Clerics must be Lawful or Chaotic. They may use any armor and shield, but they are only permitted to fight with bludgeoning weapons.

A cleric that grossly violates his alignment or uses an edged or piercing weapon loses his spell casting ability and special abilities. He cannot again gain levels as a cleric until he atones by gaining a level without his special abilities while still acting in perfect accordance with his alignment and class strictures.

Cleric Skills

Clerics add their level to the following task checks:

Conversion—Clerics are fiery, persuasive proponents of their alignment philosophy. If they can engage a sentient creature in conversation, they can attempt to convert them to their alignment.

After one hour, the cleric makes a task check (with a -5 penalty if the target's alignment is the opposite of the cleric's). If the task check is successful, the target's alignment changes to the cleric's alignment.



Conversions last for a number of hours equal to the cleric's level minus the target's Hit Dice (minimum 1 hour). After this period, there is a 90% chance that the target's alignment returns to normal.

Outsiders like demons, devils and angels cannot be swayed from their alignment by conversion.

Healing—Clerics are knowledgeable about applying bandages, mending broken bones and compounding medicines, unguents and tinctures. They can stop wounds from bleeding, and with a successful check grant a +1 bonus to save vs. ongoing poison and disease.

Cleric Abilities

A cleric casts spells from the cleric spell list. A cleric's alignment restricts him from casting spells that are opposed to his alignment. A cleric must choose and prepare his spells in advance.

Like other spell casters, a cleric can cast only a certain number of spells of each spell level each day. His daily allotment is given on the table below.

Each day, a cleric must spend one hour in prayer to regain his daily allotment of spells.

A cleric must choose the spells he will cast that day during his morning prayers. Spells come in two varieties – basic and advanced. Basic spells can be prepared by any cleric without difficulty. To prepare an advanced spell, the cleric must roll under his wisdom score minus

Cleric Advancement Table

Level	Experience Points	Hit Dice	Attack Bonus	Saving Throw	Title	Spells per Day per Spell Level								
						1	2	3	4	5	6	7	8	9
1st	0	1d6	+0	16	Beadle	2	-	-	-	-	-	-	-	-
2nd	2,100	2d6	+1	15	Almoner	3	-	-	-	-	-	-	-	-
3rd	4,200	3d6	+1	15	Chanter	3	1	-	-	-	-	-	-	-
4th	8,400	4d6	+2	14	Friar	4	2	-	-	-	-	-	-	-
5th	16,800	5d6	+3	14	Prester	4	2	1	-	-	-	-	-	-
6th	33,600	6d6	+3	13	Vidame	4	2	2	-	-	-	-	-	-
7th	67,200	7d6	+4	13	Exarch	5	3	2	1	-	-	-	-	-
8th	130,000	8d6	+5	13	Hierophant	5	3	2	2	-	-	-	-	-
9th	260,000	9d6	+5	12	Patriarch/Matriarch	5	4	3	2	1	-	-	-	-
10th	390,000	10d6	+6	12	Patriarch/Matriarch	5	4	3	2	2	-	-	-	-
11th	520,000	+2 hp	+7	11	Patriarch/Matriarch	6	4	4	3	2	1	-	-	-
12th	650,000	+2 hp	+7	11	Patriarch/Matriarch	6	4	4	3	2	2	-	-	-
13th	780,000	+2 hp	+8	10	Patriarch/Matriarch	6	5	4	4	3	2	1	-	-
14th	910,000	+2 hp	+9	10	Patriarch/Matriarch	6	5	4	4	3	2	2	-	-
15th	1,040,000	+2 hp	+9	10	Patriarch/Matriarch	6	5	5	4	4	3	2	1	-
16th	1,170,000	+2 hp	+10	9	Patriarch/Matriarch	6	5	5	4	4	3	2	1	-
17th	1,300,000	+2 hp	+11	9	Patriarch/Matriarch	6	5	5	5	4	4	3	3	1
18th	1,430,000	+2 hp	+11	8	Patriarch/Matriarch	6	5	5	5	4	4	3	3	2
19th	1,560,000	+2 hp	+12	8	Patriarch/Matriarch	6	5	5	5	5	4	4	3	3
20th	1,690,000	+2 hp	+13	7	Patriarch/Matriarch	6	5	5	5	5	4	4	4	4

the level of the spell on 1d20. If a cleric attempts to prepare a spell and fails, he may not attempt to prepare it again until 24 hours have passed.

For example, a cleric with a 13 wisdom trying to prepare an advanced 5th level spell would have to roll under an 8 on 1d20 to do so.

Clerics can “turn undead” creatures with their holy symbols. A Lawful cleric can use this ability to repel and destroy the undead, while a Chaotic anti-cleric uses it to repel and command them. See the section on Combat for more about this ability.

Fortress-Temples

A 9th level cleric can build a temple dedicated to his deity along with a fortress to protect it. This new religious community may draw the ire of established temples in nearby settlements, and could thus spark a religious war. The cleric must construct a stronghold and temple and clear a 20 mile radius area around the temple of monsters.

The new religious community attracts 1d6 first level clerics who wish to imbibe their patriarch’s wisdom, a

3rd level cleric to act as their lieutenant, 1d6x30 men-at-arms to defend the community, and 1d10 x 20 peasants, artisans and laborers to belong to it. See page 53 to roll the types of men-at-arms that are attracted.

Specialty Priests

The cleric presented above is a basic agent of Law or Chaos, or in the Medieval European sense, of God and the Devil. One can expand the horizon of the cleric by using special clerics of different cults.

These specialty clerics are called priests. Each priest gains automatic access to advanced spells of their specialty, but treat other advanced spells as though they were one level higher than they actually are. Thus the 1st level advanced spell *choir* would be considered a 2nd level advanced spell for non-Creation priests.

Unlike normal clerics, specialty priests can be Neutral.

Creation Cult

The gods of creation include creator deities and deities who rule their pantheons and the cosmos. Creation priests have control over the cosmos and its inhabitants, and act to promote their community and its rightful authorities. They are Lawful or Neutral in alignment.



Creation priests add *lightning bolt* to their list of third level spells they can prepare and *wall of fire* to the list of fourth level spells they can prepare.

Advanced Spells

1—*choir, endure elements, divine favor, random action*; 2—*calm emotions, enthrall, make whole, zone of truth*; 3—*daylight, helping hand, lightning bolt, sonic blast*; 4—*giant vermin, imbue with spell ability, spike stones, wall of fire*; 5—*command II, mark of justice, wall of stone*; 6—*banishment, forbiddance*; 7—*refuge, scourge*; 8—*crown of glory, true creation*; 9—*genesis*

Death Cult

The cult of death is feared across the land. Its black garbed priests, adorned with images of skulls, pray to such powers as Hades, Hel and Yama. Their dominion over the sanctified dead makes them a fixture in many communities, despite their association with the undead. Death priests are Neutral or Chaotic in alignment.



Death priests turn and command undead as though they were one level higher.

Advanced Spells

1—*deathwatch, detect undead, doom, invisibility to undead*; 2—*darkness, death knell, gentle repose, status*; 3—*darkness II, helping hand, speak with dead*; 4—*armor of darkness, negative energy protection, poison*; 5—*circle of doom, slay living*; 6—*create undead, curse of the mummy, undeath to death*; 7—*destruction, ethereal jaunt*; 9—*soul bind*

Fighting Cult

Fighting priests are dedicated to deities of heroism and strength and war. They defend their villages and accompany armies when they march to war. Fighting priests may be any alignment.



Fighting priests are permitted to fight with any weapon, including slashing and piercing weapons.

Advanced Spells

1—*bless weapon, divine favor, magic stone, magic weapon*; 2—*constitution, dexterity, status, strength*; 3—*sonic blast*; 4—*divine power, expunge, smite*; 5—*disrupting weapon, healing circle, righteous might*; 6—*bolt of glory, heroes' feast*; 7—*destruction*; 9—*spell immunity II*; 9—*immunity to energy, implosion*

Guardian Cult

The guardian cult is a civic cult, its priests dedicated to protecting their flock. They are Lawful or Neutral.



Once per day, a guardian priest can permit an ally to re-roll one saving throw they have failed.

Advanced Spells

1—*endure elements, entropic shield, shield of faith*; 2—*remove paralysis, shield other, undetectable alignment*; 3—*invisibility purge, protection from evil II*; 4—*dismissal, spell immunity*; 5—*break enchantment, magic resistance*; 6—*antilife shell*; 7—*refuge*; 8—*spell immunity II, surelife*; 9—*immunity to energy*

Scholar Cult

The scholar cult seeks ancient, lost knowledge and works closely with bards and magic-users in this endeavor. Scholar priests may be of any alignment.



Scholar priests, or cloistered clerics, gain the bard's lore and read languages skills and can cast spells from magic-user scrolls as though they were cleric scrolls.

Advanced Spells

1—*comprehend languages*; 2—*animal messenger, charisma, intelligence, wisdom*; 3—*meld into stone, speak with plants*; 4—*air walk, dimensional anchor, free action*; 5—*scrying*; 6—*banishment, forbiddance*; 7—*ethereal jaunt*; 8—*dimensional lock, discern location*

Travel Cult

The travel cult protects travelers, traders, pilgrims and even souls dispatched to the great beyond. They also serve as trusted messengers between nobles and royals. Travel priests are Lawful or Neutral.



Travelling priests, or friars, gain the druid's ability to move through undergrowth at their normal rate without suffering damage or other impairment.

Advanced Spells

1—*comprehend languages*; 2—*animal messenger, charisma, intelligence, wisdom*; 3—*meld into stone, speak with plants*; 4—*air walk, dimensional anchor, free action*; 5—*scrying*; 6—*banishment, forbiddance*; 7—*ethereal jaunt*; 8—*dimensional lock, discern location*

Trickster Cult

The trickster cult is dedicated to such deities of trickery, thieves and night. Neutral tricksters seek to level the field between the powerful and powerless. Chaotic tricksters seek to spread chaos and discord in the world.



Trickster priests gain the move silently and hide in shadows skills of thieves and they can fight with daggers. They may also prepare *invisibility* as a 2nd level spell.

Advanced Spells

1—*invisibility to undead, random action*; 2—*darkness, charisma, dexterity, enthrall, invisibility, undetectable alignment*; 3—*darkness II, helping hand, meld into stone*; 4—*air walk, free action, spell immunity I*; 5—*scrying*; 7—*ethereal jaunt, refuge*; 8—*spell immunity II*; 9—*immunity to energy*

Weird Cult

Not all deities fit into the normal scheme of things. Some are alien in demeanor and outlook, but still hunger for man's worship. Their clerics are eccentrics who speak of strange vistas of knowledge beyond the ken of modern man. Weird priests are Neutral or Chaotic.



Weird priests can turn and command aberrations as well as the undead. They also add the magic-user spell *insanity* to their list of 7th level spells they can prepare.

Advanced Spells

1—*comprehend languages, detect undead, random action*; 2—*charisma, darkness, enthrall, undetectable alignment*; 3—*darkness II, protection from good II*; 4—*giant vermin, imbue with spell ability*; 5—*bolts of bedevilment, circle of doom*; 6—*banishment, forbiddance*; 7—*ethereal jaunt, scourge*; 8—*dimension lock*; 9—*implosion*

Cleric Spells

1st-Level Spells

Basic

Bless/Bane
Create Water
Detect Evil/Good
Detect Poison
Mending
Purify Food & Drink
Sanctuary

Command I
Cure/Inflict Light Wounds
Detect Magic
Light
Protection from Evil/Good
Remove/Cause Fear
Summon Monster I

Advanced

Bless Weapon
Comprehend Languages
Detect Undead
Doom
Entropic Shield
Magic Stone
Random Action

Choir
Deathwatch
Divine Favor
Endure Elements
Invisibility to Undead
Magic Weapon
Shield of Faith

2nd-Level Spells

Basic

Aid
Chant
Cure/Inflict Moderate Wounds
Find Traps
Know Alignment
Silence
Spiritual Hammer

Augury
Consecrate/Desecrate
Delay Poison
Hold Person
Resist Energy
Speak with Animals
Summon Monster II

Advanced

Animal Messenger
Charisma
Darkness
Dexterity
Gentle Repose
Make Whole
Shield Other
Strength
Wisdom

Calm Emotions
Constitution
Death Knell
Enthrall
Intelligence
Remove Paralysis
Status
Undetectable Alignment
Zone of Truth

3rd-Level Spells

Basic

Animate Dead
Create Food and Water
Cure Disease*
Dispel Magic
Locate Object
Prayer
Summon Monster III

Continual Light
Cure/Cause Blindness/Deafness
Cure/Inflict Serious Wounds
Glyph of Warding
Magic Vestment
Remove/Bestow Curse
Water Walk

Advanced

Darkness II
Helping Hand
Meld into Stone
Searing Light
Speak with Dead

Daylight
Invisibility Purge
Protection from Evil/Good II
Sonic Blast
Speak with Plants

4th-Level Spells

Basic

Control Water	Cure/Inflict Critical Wounds
Detect Lie	Divination
Neutralize Poison	Planar Ally I
Restoration	Sticks to Snakes
Summon Monster IV	Tongues

Advanced

Air Walk	Armor of Darkness
Dimensional Anchor	Dismissal
Divine Power	Expunge
Free Action	Giant Vermin
Imbue with Spell Ability	Negative Energy Protection
Poison	Smite
Spell Immunity I	Spike Stones

5th-Level Spells

Basic

Atonement	Commune
Dispel Evil/Good	Flame Strike
Hallow/Unhallow	Insect Plague
Plane Shift	Raise Dead
Summon Monster V	Symbol of Pain
Symbol of Sleep	True Seeing

Advanced

Bolts of Bedevilment	Break Enchantment
Circle of Doom	Command II
Disrupting Weapon	Healing Circle
Magic Resistance	Mark of Justice
Righteous Might	Scrying
Slay Living	Wall of Stone

6th-Level Spells

Basic

Animate Object	Blade Barrier
Find the Path	Heal/Harm
Planar Ally II	Quest
Stone Tell	Summon Monster VI
Symbol of Fear	Symbol of Persuasion
Wind Walk	Word of Recall

Advanced

Antilife Shell	Banishment
Bolt of Glory	Create Undead
Curse of the Mummy	Forbiddance
Heroes' Feast	Undeath to Death

7th-Level Spells

Basic

Control Weather	Holy/Unholy Word
Regenerate	Resurrection
Summon Monster VII	Symbol of Discord
Symbol of Stunning	Symbol of Weakness

Advanced

Destruction	Ethereal Jaunt
Refuge	Scourge

8th-Level Spells

Basic

Earthquake	Holy/Unholy Aura
Planar Ally III	Summon Monster VIII
Symbol of Death	Symbol of Insanity

Advanced

Crown of Glory	Dimensional Lock
Discern Location	Spell Immunity II
Surelife	True Creation

9th-Level Spells

Basic

Astral Projection	Etherealness
Gate	Miracle
Summon Monster IX	True Resurrection

Advanced

Genesis	Immunity to Energy
Implosion	Soul Bind



The Druid

Humanoids are insignificant in the greater scheme of things, mere bagatelle to Mother Nature. Cast into the universe to fight and survive, they find a guide in the druid, who is wise and knowing and as much a part of Nature as of Civilization. Druids are True Neutral in alignment, meaning they seek balance between Law and Chaos, intervening when one philosophy gets the upper hand. When Civilization appears to have Nature on the ropes, the druid intervenes for nature, toppling city walls and releasing wolves into the streets. When Nature presses hard against Civilization, the druid turns back her horrors at the gate with Nature's own brute force at her command. Druids are both kindly and terrifying, like the primal deities they worship.

Requirements & Restrictions

To become a druid, a character must have the following minimum scores: Wis 13 and Cha 15.

Druids must be Neutral in alignment. They can use non-metallic armor and shields, and can fight with club, dagger, dart, quarterstaff, scimitar, sickle, sling and spear.

A druid who ceases to revere nature, changes to a prohibited alignment or teaches the Druidic language to a non-druid loses all spellcasting and special abilities. She cannot again gain levels as a druid until she atones by gaining a level without her special abilities, while acting in perfect accordance with her True Neutral alignment and class strictures.

Druid Skills

Druids add their level to the following skills:

Healing—Druids are knowledgeable about applying bandages, mending broken bones and compounding medicines, unguents and tinctures. They can stop wounds from bleeding, and with a successful check grant a +1 bonus to save vs. ongoing poison and disease.

Lore—Druids can recall lore about magic items and monsters. A successful lore task check reveals a magic item's powers and gives a clue to its command word, or reveals a monster's vulnerabilities.



Druid Abilities

A druid casts spells drawn from the druid spell list. A druid must prepare which spells she will cast for the day during her daily prayers. Spells come in two varieties – basic and advanced. Basic spells can be prepared by any cleric without difficulty.

Advanced spells are more difficult to access. To prepare an advanced spell, you must roll under your wisdom score minus the level of the spell on 1d20 when you try to prepare it. If a druid attempts to prepare a spell and fails, she may not attempt to prepare it again until 24 hours has passed.

Thus, a druid with a 13 wisdom trying to prepare an advanced 5th level spell would have to roll under an 8 on 1d20 to do so.

All druids learn a secret language called Druidic.

Druid Advancement Table

Level	Experience Points	Hit Dice	Attack Bonus	Saving Throw	Title	Spells per Day per Spell Level								
						1	2	3	4	5	6	7	8	9
1st	0	1d6	+0	16	Neophyte	2	-	-	-	-	-	-	-	-
2nd	2,100	2d6	+1	15	Initiate	3	-	-	-	-	-	-	-	-
3rd	4,200	3d6	+1	15	Ovate	3	1	-	-	-	-	-	-	-
4th	8,400	4d6	+2	14	Soothsayer	4	2	-	-	-	-	-	-	-
5th	16,800	5d6	+3	14	Magus	4	2	1	-	-	-	-	-	-
6th	33,600	6d6	+3	13	Shaman	4	2	2	-	-	-	-	-	-
7th	67,200	7d6	+4	13	Magister	5	3	2	1	-	-	-	-	-
8th	130,000	8d6	+5	13	Druid	5	3	2	2	-	-	-	-	-
9th	260,000	9d6	+6	12	Archdruid	5	4	3	2	1	-	-	-	-
10th	390,000	10d6	+6	12	Archdruid	5	4	3	2	2	-	-	-	-
11th	520,000	+2 hp	+7	11	Archdruid	6	4	4	3	2	1	-	-	-
12th	650,000	+2 hp	+8	11	Archdruid	6	4	4	3	2	2	-	-	-
13th	780,000	+2 hp	+8	10	Archdruid	6	5	4	4	3	2	1	-	-
14th	910,000	+2 hp	+9	10	Archdruid	6	5	4	4	3	2	2	-	-
15th	1,040,000	+2 hp	+10	10	Archdruid	6	5	5	4	4	3	2	1	-
16th	1,170,000	+2 hp	+10	9	Archdruid	6	5	5	4	4	3	2	1	-
17th	1,300,000	+2 hp	+11	9	Archdruid	6	5	5	5	4	4	3	3	1
18th	1,430,000	+2 hp	+12	8	Archdruid	6	5	5	5	4	4	3	3	2
19th	1,560,000	+2 hp	+12	8	Archdruid	6	5	5	5	5	4	4	3	3
20th	1,690,000	+2 hp	+13	7	Archdruid	6	5	5	5	5	4	4	4	4

A 2nd level druid may move through undergrowth at her normal rate and without suffering damage or other impairment. She can identify pure water, and types of plants and animals she encounters.

A 3rd level druid leaves no trail in natural surroundings and cannot be tracked unless she desires to be tracked.

A 4th level druid gets a +2 bonus to saving throws against spells of acid, cold, electricity and fire.

A 5th level druid gains the ability to turn herself into any animal and back again three times per day. Her options for new forms include all non-giant animals with as many or fewer Hit Dice as the druid has levels. The druid can remain in animal form for up to 1 hour per druid level. Each time a druid changes shape, they regain 50% of their lost hit points.

6th level druids are also immune to enchantment spells and abilities used by fey creatures.

A 9th level druid is immune to poisons.

A 12th level druid can shapechange into a plant creature with the same Hit Dice restrictions as for animal forms.

Once per day, a 16th level druid can shapechange into an air elemental, earth elemental, fire elemental or water elemental with as many Hit Dice as the druid has levels.

Sacrifices

Blood is power and blood sacrifice can convince the spirits and deities of nature to grant boons to a druid. Druids can sacrifice despoilers of the natural world to gain the ability to prepare and cast bonus spells. The types of bonus spells the druid can prepare depend on the way she sacrifices her victim.

Means of Sacrifice	Bonus Spells Prepared
Hanging or arrows	Air spells
Drowning in bog or cauldron	Water spells
Casting in spiked pit	Earth spells
Burning in wicker man	Fire spells
Dagger or sword	Divination spells

The druid can prepare and cast one bonus spell of each spell level up to the HD of the sacrificial victim, to a maximum of 5th level. A 1 HD victim permits the druid to prepare and cast one extra 1st level spell. A 5 HD victim permits the druid to prepare one extra 1st, 2nd, 3rd, 4th and 5th level spell. The druid cannot prepare and cast spells of a level to which she does not yet have access. Bonus spells last for 24 hours. If they are not cast by then, they are lost.

Sacred Sites

An archdruid can declare a site in the wilderness sacred. This could be a grove of oak trees, a natural spring or some other natural wonder. The druid must construct a stone altar at the site and spend three days and three nights fasting on the altar to consecrate it. The site then becomes a sacred site.

If the druid clears a radius of 20 miles around the altar of all despoilers of and affronts to nature, she attracts 1d6 first level druids who seek training and one 3rd level druid to serve as a lieutenant. In addition, all animals and non-chaotic elementals and fey within 20 miles of the altar become the druid's allies, passing along information and fighting for her in times of terrible crisis. All giants, oozes and dragons within 20 miles of the altar maintain a truce with the druid.

Possible Variations

Shamans replace the druid's ability to change shape with the cleric's ability to turn and destroy undead.



1st-Level Spells

Basic

Animal Friendship	Charm Animal
Create Water	Detect Animals or Plants
Detect Magic	Detect Poison
Detect Snares and Pits	Discern Aura
Entangle	Faerie Fire
Flare	Hide from Animals
Know Direction	Light
Mending	Obscuring Mist
Pass without Trace	Produce Flame
Purify Food & Drink	Shillelagh
Speak with Animals	Summon Nature's Ally I

Advanced

Calm Animals	Elemental Weapon
Endure Elements	Goodberry
Jump	Longstrider
Magic Fang	Magic Stone

2nd-Level Spells

Basic

Barkskin	Charm Person
Cure Light Wounds	Fire Trap
Heat/Chill Metal	Hold Animal
Resist Energy	Summon Nature's Ally II
Warp Wood	

Advanced

Animal Messenger	Animal Trance
Charisma	Constitution
Delay Poison	Dexterity
Flame Blade	Flaming Sphere
Fog Cloud	Gust of Wind
Intelligence	Lighten Burden
Reduce Animal	Soften Earth and Stone
Spider Climb	Strength
Summon Swarm	Tree Shape
Wisdom	Wood Shape

3rd-Level Spells

Basic

Call Lightning	Cure/Cause Disease
Cure Moderate Wounds	Neutralize Poison
Plant Growth	Protection from Energy
Pyrotechnics	Snare
Speak with Plants	Stone Shape
Summon Nature's Ally III	Water Breathing

Advanced

Daylight	Diminish Plants
Dominate Animal	Know Alignment
Meld into Stone	Poison
Quench	Sleet Storm
Spike Growth	Wind Wall

4th-Level Spells**Basic**

Antiplant Shell	Cure Serious Wounds
Dispel Magic	Flame Strike
Hallucinatory Terrain	Insect Plague
Repel Vermin	Summon Nature's Ally IV

Advanced

Air Walk	Blight
Command Plants	Control Water
Free Action	Giant Vermin
Ice Storm	Rusting Grasp
Scrying	Spike Stones

5th-Level Spells**Basic**

Animal Growth	Commune with Nature
Control Winds	Cure Critical Wounds
Feeblemind	Hold Monster
Sticks to Snakes	Summon Nature's Ally V
Transmute Rock to Mud	Tree Stride
Wall of Fire	Wall of Thorns

Advanced

Atonement	Awaken
Call Lightning Storm	Negative Energy Protection
Polymorph Other	Stoneskin

6th-Level Spells**Basic**

Antilife Shell	Fire Seeds
Reincarnate	Repel Wood
Summon Nature's Ally VI	Transport via Plants

Advanced

Balance	Dart of Mistletoe
Find the Path	Healing Circle
Ironwood	Liveoak
Move Earth	Spellstaff
Stone Tell	Wall of Stone

7th-Level Spells**Basic**

Animate Stone	Confusion
Control Weather	Creeping Doom
Fire Storm	Heal/Harm
Summon Nature's Ally VII	Transmute Metal to Wood

Advanced

Animate Plant	Changestaff
Chariot of Fire	Sunbeam
True Seeing	Wind Walk

8th-Level Spells**Basic**

Control Plants	Earthquake
Finger of Death	Summon Nature's Ally VIII

Advanced

Animal Shapes	Repel Metal or Stone
Reverse Gravity	Sunburst
Whirlwind	Word of Recall

9th-Level Spells**Basic**

Foresight	Immunity to Energy
Shapechange	Summon Nature's Ally IX

Advanced

Antipathy/Sympathy	Elemental Swarm
Horrid Wilting	Regenerate
Shambler	Storm of Vengeance



The Duelist

Duelists are warriors who learn to fight using trickery, fancy swordplay and quick reflexes rather than armor and shields. Duelists may be swashbuckling rogues or serious and studious masters of the art of fence.

Requirements & Restrictions

To become a duelist, a character must have the following minimum scores: Str 9, Int 9 and Dex 15.

They can use leather armors and bucklers, and can fight with all weapons.

Duelist Skills

Duelists add their level to the following task checks:

Acrobatics—Duelists can walk tightropes, tumble past opponents and swing from chandeliers.

Taunt—Duelists keep up the witty repartee while they are fighting, attacking with words as well as weapons. When an opponent misses them in combat, the duelist can attempt to task check to taunt them into becoming enraged and sloppy. With each success, the foe suffers a -2 penalty to Armor Class, but gains a +1 bonus to damage against the duelist when they hit in combat.

Duelist Abilities

Duelists are only surprised on a roll of 1 on 1d6.

Duelists gain a bonus to Armor Class based on their level.



Duelists specialize in one particular weapon. They can choose this weapon from among daggers, light and medium swords and the quarterstaff. When fighting with their specialist weapon, a duelist inflicts +1d6 damage. When fighting a non-duelist using this weapon, they enjoy a +2 bonus to attack.

If a duelist chooses to parry instead of attack, they may roll a normal attack and use the value of the roll as their Armor Class for that round against melee attacks.

A duelist springs into combat with relish. When rolling for initiative, the duelist can roll his own d6 for initiative and act on the better of that roll or the roll for his side.

A 3rd level duelist enjoys the services of a lackey. The type of lackey should be rolled on the following table. If the duelist is Neutral, add 1 to the roll. If the duelist is Lawful, add 2 to the roll.

Roll	Lackey	Special Ability
1	Scoundrel	Backstab +1d6
2	Lack-wit	Accidentally solve riddles (2 in 6 chance)
3-4	Oaf	Break down door (4 in 6 chance)
5-6	Toady	Spy on enemies (3 in 6 chance)
7	Picaro	+1 bonus to taunt task checks
8	Valet	+1 reaction bonus

Lackeys will not fight for a duelist, though they do defend themselves if attacked. A lackey's job is to cook, clean, shop, carry and maintain gear, deliver messages and take the blame when the duelist errs. The lackey works for room, board and 1 gp to celebrate holidays.

A 6th level duelist gains the ability to riposte. When an opponent misses the duelist in combat while the duelist is parrying, the duelist scores +1d6 damage against that opponent if they hit in the next round. If the duelist is using his weapon of choice, he does +2d6 damage.

Duelist Class Advancement

Level	Experience Points	Hit Dice	Attack Bonus	Saving Throw	AC Bonus	Title
1st	0	1d8	+1	17	+1	Rascal
2nd	2,000	2d8	+2	16	+1	Rogue
3rd	4,000	3d8	+3	16	+1	Rake
4th	8,000	4d8	+4	15	+1	Romantic
5th	16,000	5d8	+5	15	+2	Swashbuckler
6th	32,000	6d8	+5	14	+2	Daredevil
7th	64,000	7d8	+6	14	+2	Swordsman
8th	120,000	8d8	+7	13	+2	Avenger
9th	240,000	9d8	+8	13	+3	Fencing Master
10th	360,000	10d8	+9	12	+3	Fencing Master
11th	480,000	+3 hp	+10	12	+3	Fencing Master
12th	600,000	+3 hp	+10	11	+3	Fencing Master
13th	720,000	+3 hp	+11	11	+4	Fencing Master
14th	840,000	+3 hp	+12	10	+4	Fencing Master
15th	960,000	+3 hp	+13	10	+4	Fencing Master
16th	1,080,000	+3 hp	+14	9	+4	Fencing Master
17th	1,200,000	+3 hp	+15	9	+5	Fencing Master
18th	1,320,000	+3 hp	+15	8	+5	Fencing Master
19th	1,440,000	+3 hp	+16	8	+5	Fencing Master
20th	1,560,000	+3 hp	+17	7	+5	Fencing Master

At 12th level, the duelist can roll with a potentially lethal blow to take less damage than he normally would. Once per day, when he would be reduced to 0 or fewer hit points by damage from a melee or ranged attack, but not a spell or special ability, the duelist can make a saving throw. If the save succeeds, he takes half damage from the blow; if it fails, he takes full damage.

Carte Blanche

A 9th level duelist can become an agent of a noble or royal personage. As an agent, he is expected to engage in dangerous or secret missions on their behalf, and carries a *carte blanche* signed by his employer, allowing him to commit any act, no matter how criminal, with impunity.

For cover, the duelist runs a fencing academy in a town or city. He attracts 1d6 x 10 students (0 HD, and often of high birth), who pay a fee of 9 sp per student per month to be taught the art of fence. In addition, the duelist attracts 1d6 first level duelists to train under him, and a 3rd level duelist to serve as his second.

Possible Variations

Marksmen replace the duelist's melee specialization with specialization with a ranged weapon. In place of a riposte, the marksman gains the ability to deal +2d6 points of damage on a successful ranged attack with his specialist weapon or +1d6 points of damage with other ranged weapons when he takes two full rounds to line up the shot before shooting.

Sea dogs replace the duelist's skills with skill at climbing walls, navigation and moving silently.



The Fighter

Fighters are conquerors. They conquer fear, they conquer foes, and if they live long enough and keep their wits about them, they conquer kingdoms. Fighters are trained in the military arts, practicing with all forms of weaponry and comfortable in heavy armor. They know the life of campaigning, of sleeping in the mud, of staring down a charging horde, of trusting in the courage of the person standing next to them.

Requirements & Restrictions

Fighters must have a strength score of at least 9. They can be of any alignment, use any armor, and employ any weapon in combat.

Fighter Skills

Fighters add their level to the following task checks:

Riding—Fighters are capable of attacking from horseback at no penalty, and can attempt task checks to remain in the saddle when suffering damage and for performing dangerous riding stunts.



Fighter Abilities

Fighters excel at leading warriors into battle. Men-at-arms under their command get a +1 bonus to moral checks.

Fighters can dominate weaker foes in combat. If faced with a group of monsters within weapon's reach, the fighter can choose to attack a number of hit dice worth of opponents equal to his level, making a single attack against each opponent.

Against a single foe, a fighter gains extra attacks per round as he advances in level, as shown on the chart below. When the chart shows a "+" after the number, it means if the fighter's last attack on the foe does damage, he may make a bonus attack.

Wondrous Mounts

All fighters are adept at riding horses into battle, but as fighters gain levels, they gain the ability to subdue other creatures and turn them into fighting mounts.

Level	Can Subdue ...
3rd	Non-traditional animal mounts and giant vermin
5th	Monsters with animal intelligence
7th	Monsters with higher than animal intelligence*
9th	Dragons

* *Subduing a Lawful or Neutral sentient monster is an evil act.*

Non-traditional animal mounts include animals not usually domesticated and ridden in the real world.

To subdue a creature, a fighter must attack to subdue, rather than to kill. Subduing attacks are made at a -2 penalty and damage is not deducted from the monster's hit points, but rather recorded separately. At the end of each round, calculate the percentage of the fighter's subduing damage to the monster's hit points. This is the chance that the monster has been intimidated and cowed into surrender, and thus subdued. Roll this chance at the end of each round.

For example, a mantichore has 20 hit points. A fighter wants to subdue it and use it as his mount. In the first round of combat, the fighter scores 6 points of damage against the mantichore. Six is 30% of the mantichore's total of 20 hit points, so at the end of the first round, there is a 30% chance that the mantichore is subdued. Two rounds later, the fighter has scored another 5 points of damage. Since 11 is 55% of 20, at the end of the third round there is a 55% chance that the mantichore is subdued.

Fighter Class Advancement Table

Level	Experience Points	Hit Dice	Attack Bonus	Saving Throw	Attacks/Round	Title
1st	0	1d8	+1	17	1	Armsman
2nd	2,000	2d8	+2	16	1	Warrior
3rd	4,000	3d8	+3	16	1	Champion
4th	8,000	4d8	+4	15	1	Gladiator
5th	16,000	5d8	+5	15	1	Swashbuckler
6th	32,000	6d8	+5	14	1	Grognard
7th	64,000	7d8	+6	14	1+	Freelance
8th	125,000	8d8	+7	13	1+	Master-of-Arms
9th	250,000	9d8	+8	13	1+	Warlord
10th	375,000	10d8	+9	12	1+	Warlord
11th	500,000	+3 hp	+10	12	1+	Warlord
12th	625,000	+3 hp	+10	11	1+	Warlord
13th	750,000	+3 hp	+11	11	2	Warlord
14th	875,000	+3 hp	+12	10	2	Warlord
15th	1,000,000	+3 hp	+13	10	2	Warlord
16th	1,125,000	+3 hp	+14	9	2	Warlord
17th	1,250,000	+3 hp	+15	9	2	Warlord
18th	1,375,000	+3 hp	+15	8	2	Warlord
19th	1,500,000	+3 hp	+16	8	2+	Warlord
20th	1,625,000	+3 hp	+17	7	2+	Warlord

Non-intelligent animals and monsters remain subdued until they are freed by the fighter. Intelligent monsters and dragons take the first opportunity to flee, and probably to take revenge at some point afterwards.

Strongholds

At 9th level, a fighter can establish a stronghold in the wilderness and take the title of baron or baroness. The fighter may declare himself a Free Baron, or he may pledge fealty to a more powerful noble. Free barons may come into conflict with the noble (or nobles) who rules the civilized territory nearest the new barony.

When a warlord becomes a baron he attracts 3d4x10 men-at-arms. Visit page 53 to determine the type of men-at-arms, rolling once for every 20 warriors. One of every 10 men-at-arms is a sergeant. The men-at-arms are led by a lieutenant fighter of level 4 to 7. These men-at-arms are mercenaries who must be paid (see Henchmen under Equipment for the going rate for sell-swords).

The new baron also attracts 1d10x40 peasants, artisans and laborers to his new barony. These people are yeomen who expect to be treated as free people.

Possible Variations

Cavaliers Replace multiple attacks with no penalty to fight from horseback, immunity to fear, and a +1 bonus to attack and damage with lances per four levels, a +1 bonus to attack and damage with longswords and curved swords per five levels, and a +1 bonus to attack and damage with horseman's axes, horseman's maces, and horseman's flails per six levels (round down).

Defenders replace multiple attacks with the ability to be "steadfast" in combat. While steadfast, defenders enjoy a +2 bonus on saving throws, a +2 bonus to AC, and they are immune to being knocked over or moved in combat. In addition, the steadfast defender can deflect missiles as a monk of equal level. While steadfast, the defender cannot move, for he must stand his ground.

Sentinels replaces multiple attacks with only being surprised on a roll of 1 on 1d6, find secret doors and hear noise as skills, a +2 bonus to save vs. sleep magic and a +1 bonus to attack and damage with pole-arms per five levels (round down).

The Magic-User

Unlike the sorcerer, those eccentric and unwholesome aristocrats of magic who are born to magic, the magic-user must study day and night to achieve his mastery of the magic arts. The magic-user is ambitious, driven and never satisfied while there are secrets yet unrevealed.

Requirements & Restrictions

Magic-users must have an intelligence of 9 or higher. They cannot use armor or shields, and fight with clubs, daggers, darts, crossbows (hand and light) and staves.

Magic-User Skills

Alchemy—A magic-user is skilled in the laboratory, and can identify chemicals and alchemical paraphernalia.

Lore—Magic-users can recall lore about magic items and monsters. A successful lore check reveals a magic item's powers and gives a clue to its command word, or reveals a monster's vulnerabilities.

Magic-User Abilities

A magic-user casts spells from the magic-user spell list. A magic-user can cast only a certain number of spells of each spell level per day. His base daily spell allotment is given on the table below.

There is no limit to the number of spells a magic-user can know. He must choose and prepare the spells he is going to cast ahead each morning by spending one hour studying his spellbook. While studying, the magic-user decides which spells to prepare. He cannot prepare any spell not recorded in his spellbook, except for *read magic*, which all magic-users can prepare from memory.

A magic-user begins play with a spellbook containing four 1st-level spells, one of them *read magic*. A magic-user learns one new spell at each level. He also can learn spells found in other spellbooks or on scrolls to his spellbook, and he can conduct research to learn or invent new spells.

Spells come in two varieties – basic and advanced. Basic spells can be learned by any magic-user and added to his spellbook without difficulty.

Advanced spells must be found on adventures or researched. To learn an advanced spell and add it to your spellbook, you must roll under your intelligence score minus the level of the spell on 1d20. If a magic-user attempts to learn a spell and fails, he may not attempt to learn it again until he gains a new level.

For example, a magic-user with a 13 intelligence trying to learn an advanced 5th level spell would have to roll under an 8 on 1d20 to do so and add it to his spellbook.

Magic-User Advancement Table

Level	Points	Dice	Bonus	Throw	Title	Spells per Day per Spell Level								
						1st	2nd	3rd	4th	5th	6th	7th	8th	9th
1st	0	1d4	+0	15	Adept	2	-	-	-	-	-	-	-	-
2nd	2,000	2d4	+0	14	Medium	3	-	-	-	-	-	-	-	-
3rd	4,000	3d4	+1	14	Invoker	3	1	-	-	-	-	-	-	-
4th	8,000	4d4	+1	14	Mage	4	2	-	-	-	-	-	-	-
5th	16,000	5d4	+1	13	Spellbinder	4	2	1	-	-	-	-	-	-
6th	32,000	6d4	+2	13	Grammarian	4	3	2	-	-	-	-	-	-
7th	64,000	7d4	+2	12	Marvel	5	3	2	1	-	-	-	-	-
8th	125,000	8d4	+3	12	Archmage	5	3	3	2	-	-	-	-	-
9th	250,000	9d4	+3	12	Wizard	5	4	3	2	1	-	-	-	-
10th	375,000	10d4	+3	11	Wizard	5	4	3	3	2	-	-	-	-
11th	500,000	+1 hp	+4	11	Wizard	5	4	4	3	2	1	-	-	-
12th	625,000	+1 hp	+4	11	Wizard	5	4	4	3	3	2	-	-	-
13th	750,000	+1 hp	+5	10	Wizard	5	4	4	4	3	2	1	-	-
14th	875,000	+1 hp	+5	10	Wizard	5	4	4	4	3	3	2	-	-
15th	1,000,000	+1 hp	+5	10	Wizard	5	4	4	4	4	3	2	1	-
16th	1,125,000	+1 hp	+6	9	Wizard	5	4	4	4	4	3	3	1	-
17th	1,250,000	+1 hp	+6	9	Wizard	5	4	4	4	4	4	3	2	1
18th	1,375,000	+1 hp	+7	9	Wizard	5	4	4	4	4	4	3	3	2
19th	1,500,000	+1 hp	+7	8	Wizard	5	4	4	4	4	4	4	3	3
20th	1,625,000	+1 hp	+7	8	Wizard	5	4	4	4	4	4	4	4	4



Magic-users can create spell scrolls, but not protection scrolls, starting at 1st level.

As they advance in level and research new spells, magic-users often come across tidbits of arcane knowledge. At every odd level beyond 1st level, roll on the table to the right to discover what they learn. If a duplicate is rolled, roll again until you get a new piece of knowledge.

Wizard Towers

An 11th level magic-user can choose to establish a tower in the wilderness where he may focus on completing an act of powerful magic that will cement his reputation for all time. This might be attaining lich-hood or the creation of powerful spells that he names after himself, or some other wonder.

The wizard seeks solitude and so builds his tower as far away from others as possible, yet he must still contend with nosy adventurers, rapacious dragons and the might of nearby kingdoms that fear what he might create.

The wizard attracts 1d6 first level magic-users who wish to train under them, one 3rd level magic-user to serve as a laboratory assistant and 1d4+1 x 10 men-at-arms to guard the tower. Lawful magic-users have a 1 in 6 chance of instead getting elves. Chaotic magic-users have a 1 in 6 chance of instead getting goblins.

d%	Arcane Knowledge
01-14	Learn algebra and geometry
15-21	Learn to make gunpowder (10 shots; 1 gp, 1 day)
22-28	Learn to make soda water (1 gal., 1 gp, 1 day)
29-35	Learn to brew acid (1 flask, 5 gp, 1 day)
36-41	Learn to make flash powder (1 pinch, 5 gp, 1 day)
42-47	Learn to make glue (1 oz., 5 gp, 1 day)
48-53	Learn distillation (1 pint, 10 gp, 1 day)
54-59	Learn to brew alchemist's fire (1 flask, 10 gp, 1 day)
60-64	Learn to make a compass (10 gp, 1 day)
65-69	Learn to produce phosphorus (1 oz., 20 gp, 1 day)
70-73	Learn to make anti-toxin (1 dose, 25 gp, 1 day)
74-77	Learn to make sneezing powder (1 pinch, 30 gp, 1 day)
78-81	Learn to make invisible ink (1 oz., 50 gp, 1 day)
82-84	Learn to brew Poison I (1 dose, 100 gp, 1 day)
85-87	Learn to make a steam engine (1 hp, 200 gp, 1 week)
88-89	Learn the secret of silver plating for weapons
90	Learn to make artificial gemstones and pearls
91	Learn to make mechanical clock (500 gp, 1 months)
92	Learn to make telescopes (500 gp, 1 week)
93	Learn to make <i>vitrum flexile</i> (1 sq. ft., 750 gp, 1 week)
94	Learn to make simple glider (1,000 gp, 1 month)
95	Learn to make a hot air balloon (5,000 gp, 1 year)
96	Learn to hypnotize using crystals hanging on chains (Intelligence task check, as spell)
97	Learn the healing skill of clerics and druids
98	Learn the secret of working adamantine
99	Learn secret of making a homunculus
00	Learn to make hybrid monsters

Specialist Mages

Magic can be divided into eight schools. Each school consists of a number of spells with a common theme. A magic-user can choose at 1st level to specialize in one school of magic if he can qualify (see below).

School	Specialist	Requirement
Abjuration	Abjurer	Wis 13 or higher
Conjuration	Conjurer	Cha 13 or higher
Divination	Diviner	Wis 13 or higher
Enchantment	Enchanter	Cha 13 or higher
Evocation	Evoker	Cha 13 or higher
Illusion	Illusionist	Dex 13 or higher
Necromancy	Necromancer	Con 13 or higher
Transmutation	Transmuter	Wis 13 or higher

Specialists are +1 to save vs. spells of their specialized school. They treat advanced spells of their specialized school as though they were basic, and thus do not need to make a roll to learn them. They also can cast one extra 1st level spell per day from their specialized school. In return, they treat advanced spells from other schools as though they were two levels higher.

Magic-User Spells

1st-Level Spells

Basic

Charm Person [E]	Comprehend Languages [D]
Daze [E]	Detect Magic [D]
Detect Poison [D]	Floating Disk [V]
Hold Portal [A]	Light [V]
Mage Hand [T]	Magic Missile [V]
Open/Close [T]	Phantasmal Force [I]
Prestidigitation [I]	Protection from Evil* [A]
Read Magic [D]	Resistance [A]
Shield [A]	Sleep [E]
Ventriloquism [I]	Wizard Mark [T]

Advanced

Acid Splash [C]	Alarm [A]
Animate Rope [T]	Audible Glamer [I]
Burning Hands [V]	Cause Fear [N]
Change Self [I]	Chill Touch [N]
Color Spray [I]	Dancing Lights [V]
Detect Secret Doors [D]	Detect Undead [D]
Disrupt Undead [N]	Elemental Weapon [T]
Endure Elements [A]	Energy Missile [V]
Enlarge Person [T]	Erase [T]
Expeditious Retreat [T]	Feather Fall [T]
Flare [V]	Fool's Gold [T]
Grease [C]	Hypnotism [E]
Identify [D]	Ill Omen [E]
Jump [T]	Mage Armor [C]
Magic Aura [I]	Magic Weapon [T]
Mending [T]	Message [T]
Mind Thrust [V]	Mount [C]
Obscuring Mist [C]	Precognition [D]
Ray of Enfeeblement [N]	Ray of Frost [V]
Reduce Person [T]	Reflect Gaze [A]
Shocking Grasp [V]	Smoke Image [T]
Summon Monster I [C]	Touch of Fatigue [N]
True Strike [D]	Unseen Servant [C]

2nd-Level Spells

Basic

Continual Light [V]	Darkvision [T]
Detect Evil* [D]	Detect Invisibility [D]
ESP [D]	Invisibility [I]
Knock [T]	Levitate [T]
Locate Object [D]	Protection from Arrows [A]
Web [C]	Wizard Lock [A]

Advanced

Acid Arrow [C]	Alter Self [T]
Blindness/Deafness [I]	Blur [I]
Brain Lock [E]	Charisma [T]
Command Undead [N]	Constitution [T]
Darkness [V]	Daze Monster [E]
Dexterity [T]	Ego Whip [E]
False Life [N]	Find Familiar
Flaming Sphere [V]	Fog Cloud [C]
Ghoul Touch [N]	Glitterdust [C]
Gust of Wind [V]	Hideous Laughter [E]
Hypnotic Pattern [I]	Intelligence [T]
Know Alignment [D]	Magic Mouth [I]
Mirror Image [I]	Misdirection [I]
Obscure Object [A]	Pass Through Element [A]
Phantasmal Force II [I]	Phantom Trap [I]
Pyrotechnics [T]	Resist Energy [A]
Rope Trick [T]	Scare [N]
Scorching Ray [V]	Shatter [V]
Spectral Hand [N]	Spider Climb [T]
Stomp [EV]	Strength [T]
Summon Monster II [C]	Summon Swarm [C]
Thought Shield [A]	Touch of Idiocy [E]
Whispering Wind [T]	Wisdom [T]

3rd-Level Spells

Basic

Clairsentience [D]	Dispel Magic [A]
Fireball [V]	Fly [T]
Gaseous Form [T]	Haste [T]
Hold Person [E]	Invisibility Sphere [I]
Lightning Bolt [V]	Protection from Evil II* [A]
Tongues [D]	Water Breathing [T]

Advanced

Blink [T]	Body Adjustment [C]
Daylight [V]	Displacement [I]
Explosive Runes [A]	Flame Arrow [T]
Gentle Repose [N]	Heroism [E]
Hold Undead [N]	Illusory Script [I]
Keen Edge [T]	Mental Barrier [A]
Nondetection [A]	Phantom Steed [C]
Protection from Energy [A]	Psionic Blast [V]
Rage [E]	Ray of Fatigue [N]
Secret Page [T]	Sepia Snake Sigil [C]
Shockwave [V]	Shrink Item [T]
Sleep II [E]	Sleet Storm [C]
Slow [T]	Spectral Force [I]
Stinking Cloud [C]	Suggestion [E]
Summon Monster III [C]	Tiny Hut [V]
Vampiric Touch [N]	Wind Wall [V]

4th-Level Spells

Basic

Animate Dead [N]
Charm Monster [E]
Dimension Door [C]
Hallucinatory Terrain [I]
Polymorph Self [T]
Wall of Ice [V]

Bestow Curse* [N]
Confusion [E]
False Forest [I]
Polymorph Other [T]
Wall of Fire [V]
Wizard Eye [D]

Advanced

Black Tentacles [C]
Choke [N]
Crushing Despair [E]
Dimensional Anchor [A]
Enervation [N]
Fire Shield [V]
Globe of Invulnerability I [A]
Illusory Wall [I]
Invisibility II [I]
Mnemonic Enhancer [T]
Rainbow Pattern [I]
Scrying [D]
Shadow Conjuration I [I]
Solid Fog [C]
Stoneskin [A]

Cause Disease [N]
Creation I [C]
Detect Scrying [D]
Dispel Wounds [I]
Fear [N]
Fire Trap [A]
Ice Storm [V]
Locate Creature [D]
Phantasmal Killer [I]
Resilient Sphere [V]
Secure Shelter [C]
Shout [V]
Stone Shape [T]
Summon Monster IV [C]

5th-Level Spells

Basic

Animal Growth [T]
Cloudkill [C]
Feeblemind [E]
Magic Jar [N]
Telekinesis [T]
Transmute Rock to Mud* [T]

Break Enchantment [A]
Contact Other Plane [D]
Hold Monster [E]
Passwall [T]
Teleport [C]
Wall of Stone [C]

Advanced

Bedlam [E]
Cone of Cold [V]
Dismissal [A]
Dream [I]
False Vision [I]
Mage's Faithful Hound [C]
Mind Fog [E]
Nightmare [I]
Permanency
Planar Binding I [C]
Psychic Crush [V]
Seeming [I]
Shadow Evocation I [I]
Symbol of Pain [N]
Telepathic Bond [D]
Wall of Force [V]

Blight [N]
Creation II [C]
Dominate Person [E]
Fabricate [T]
Interposing Hand [V]
Mage's Private Sanctum [A]
Mirage Arcana [I]
Overland Flight [T]
Persistent Illusion [I]
Prying Eyes [D]
Secret Chest [C]
Sending [V]
Summon Monster V [C]
Symbol of Sleep [E]
Tower of Iron Will [A]
Waves of Fatigue [N]

6th-Level Spells

Basic

Antimagic Field [A]
Control Water [T]
Flesh to Stone* [T]
Guards and Wards [A]
Mathemagic Principal [D]
Reincarnate [T]

Cone of Paralysis [I]
Disintegrate [T]
Geas [E]
Legend Lore [D]
Move Earth [T]
Wall of Iron [C]

Advanced

Analyze Dweomer [D]
Circle of Death [N]
Create Undead [N]
Death Fog [C]
Eyebite [N]
Freezing Sphere [V]
Mage's Lucubration [T]
Mislead [I]
Planar Binding II [C]
Programmed Illusion [I]
Shadow Walk [I]
Symbol of Fear [N]
Transformation [T]
Undeath to Death [N]

Chain Lightning [V]
Contingency [V]
Crystallize [T]
Density Control [T]
Forceful Hand [V]
Globe of Invulnerability II [A]
Mass Suggestion [E]
Permanent Illusion [I]
Probe Thoughts [D]
Repulsion [A]
Summon Monster VI [C]
Symbol of Persuasion [E]
True Seeing [D]
Veil [I]

7th-Level Spells

Basic

Control Weather [T]
Finger of Death [N]
Mass Invisibility [I]
Project Image [I]

Delayed Blast Fireball [V]
Limited Wish
Phase Door [C]
Reverse Gravity [T]

Advanced

Banishment [A]
Earthwalk [T]
Fission [T]
Grasping Hand [V]
Instant Summons [C]
Mage's Sword [V]
Power Word Blind [E]
Sequester [A]
Simulacrum [I]
Statue [T]
Symbol of Stunning [E]
Teleport Without Error [C]
Vanish [C]

Control Undead [N]
Ethereal Jaunt [T]
Forcecage [V]
Insanity [E]
Magnificent Mansion [C]
Plane Shift [C]
Prismatic Spray [V]
Shadow Conjuration II [I]
Spell Turning [A]
Summon Monster VII [C]
Symbol of Weakness [N]
Ultrablast [V]
Vision [D]

8th-Level Spells

Basic

Antipathy [E]
Incendiary Cloud [C]
Maze [C]
Sympathy [E]

Clone [N]
Mass Charm [E]
Mind Blank [A]
Two Dimensional [T]

Advanced

Binding [E]	Clenched Fist [V]
Crystal-Steel [T]	Demand [E]
Dimensional Lock [A]	Discern Location [A]
Horrid Wilting [N]	Iron Body [T]
Irresistible Dance [E]	Moment of Prescience [D]
Planar Binding III [C]	Polar Ray [V]
Polymorph Any Object [T]	Power Word Stun [E]
Prismatic Wall [A]	Protection from Spells [A]
Scintillating Pattern [I]	Screen [I]
Shadow Evocation II [I]	Summon Monster VIII [C]
Sunburst [V]	Symbol of Death [N]
Symbol of Insanity [E]	Telekinetic Sphere [V]
Temporal Stasis [T]	Trap the Soul [C]

9th-Level Spells

Basic

Astral Projection [V]	Gate [C]
Imprisonment [A]	Meteor Swarm [V]
Prismatic Sphere [A]	Shapechange [T]
Time Stop [T]	Wish

Advanced

Crushing Hand [V]	Dominate Monster [E]
Energy Drain [N]	Etherealness [T]
Foresight [D]	Freedom [A]
Fusion [T]	Mage's Disjunction [A]
Power Word Kill [E]	Refuge [C]
Shades [I]	Soul Bind [N]
Summon Monster IX [C]	Teleportation Circle [C]
Wail of the Banshee [N]	Weird [I]



The Monk

Monks are members of orders who pursue a course of exercise and study that aims for the perfection of mind, body and spirit. Because they live in a fantasy gaming world, they direct this perfection into fighting and surviving. While monks learn their art in secret monasteries dedicated to a philosophy or religious faith (i.e. an alignment), at the end of their training they are sent out into the world to gain greater experience and perfect their already skills. It is during this wandering that a monk goes on adventures.

One may note that there is a seeming overlap between clerics, druids and them. This is not the case. Where clerics and druids are very outward looking, monks are inward looking. They seek their own perfection, not the perfection of the world. While monks may council people on the benefits of doing things their way, they do not proselytize or call people to witness the power of their faith or philosophy. Rather, they guide by quiet example.

Requirements & Restrictions

To become a monk, a character must have the following minimum scores: Str 12, Wis 13 and Dex 15.

They may not use armor or shields of any kind, but can fight with any weapon.

Monk Skills

Monks add their level to the following task checks:

Acrobatics—Monks can walk tightropes, tumble past opponents and swing from chandeliers.

Climb Walls—Monks can climb walls without climbing gear at a rate of 10' per round. If a monk falls, they suffer damage as though the fall were 20' shorter.

Hear Noise—Monks can hear incredibly quiet noises through doors or from far away.

Hide in Shadows—Monks can disappear into the shadows and remain unseen, even while moving.

Move Silently—Monks can walk slowly without making a sound if they are not in metal armor.

Open Locks—Monks can use thieves' tools to open locks.

Read Languages—Monks can read languages unknown to them. After 9th level, a monk can use this ability to read a magic-user scroll and cast the spell.



Monk Abilities

As the monk advances in level, they improve their AC, number of unarmed attacks per round, unarmed damage and movement rate (see table below). Monks also inflict +1 point of damage per two levels with melee weapons.

Monks are only surprised on a roll of 1 on 1d6.

Monks gain several immunities as they advance in level: To disease and *slow* spells at 5th level, *geas* and *quest* spells at 10th level and poison at 11th level. At 6th level they are 90% resistant to mind reading and control.

When a monk beats a target's AC with her attack roll by 4 or more, that target must succeed at a saving throw or be stunned for 1d6 rounds. This does not apply against oozes, plants, constructs, undead and elementals.

A 2nd level monk learns to deflect arrows and other small missiles with their hands. The monk can attempt, once per round, to deflect a missile that would otherwise hit them by making a saving throw.

A 4th level monk can damage monsters only damaged by silver or +1 *magic weapons*. At 10th level they can damage monsters only harmed by +2 *magic weapons*. At 16th level they can damage monsters only harmed by +3 *magic weapons* or better.

4th level monks can speak with animals. This extends to plants at 8th level and all sentient creatures at 17th.

6th level monks can feign death, slowing their breathing and heartbeat to appear dead for up to 1 hour.

A 7th level monk can heal her wounds using meditation. She can heal a number of hit points of damage equal to her level each day, and can use this healing at once or spread this healing out among several uses.

A 15th level monk can set up vibrations within the body of another creature that can thereafter be fatal if and when the monk commands. She can use this "quivering palm" attack once a week and she must announce her intent to do so before making her attack roll to do so.

Constructs, oozes, plants, undead and incorporeal creatures cannot be affected. Otherwise, if the monk attacks successfully and the target takes damage from the blow, the quivering palm attack succeeds. Thereafter the monk can slay the victim at any time within one week. To do so, the monk wills the target to die. Unless the target makes a saving throw vs. death, it dies. If the saving throw is successful, the target is no longer in danger from the quivering palm.

Monasteries

A 9th level monk can choose to establish a hidden monastery in the wilderness and gain followers. At the heart of the monastery there must be a powerful magic item or artifact claimed by the monk during one of their adventures. The monks swear an oath to protect the item and keep it hidden from the outside world.

A monk who builds a monastery and drives off all of the monsters within 20 miles becomes an abess or abbot.

An abess attracts students as follows: One monk of half the abess' level, rounding up, to serve as her lieutenant, plus 1d6 second level monks, 2d6 first level monks and 3d6 0 HD humans and demi-humans.

These students all share the same basic alignment (i.e. Lawful, Neutral or Chaotic) as their master.

Each spring, each 2nd level monk of the monastery has a 1 in 6 chance of leaving to become an adventurer, and each 1st level monk has a 1 in 10 chance of advancing to 2nd level. Each 0 HD student has a 5% chance to become a 1st level monk, all others drop out, and another 3d6 0 HD students join the monastery seeking training.

Monk Advancement Table

Level	Experience Points	Hit Dice	Attack Bonus	Saving Throw	Title	AC Bonus	Unarmed Attacks	Unarmed Damage	Movement Rate
1st	0	1d6	+0	15	Postulant	+0	1	1d4	+0 ft.
2nd	2,100	2d6	+1	14	Novice	+1	1	1d4	+5 ft.
3rd	4,200	3d6	+1	14	Brother	+1	1	1d6	+5 ft.
4th	8,400	4d6	+2	13	Cenobite	+2	1	1d6	+10 ft.
5th	16,800	5d6	+3	13	Mendicant	+2	1	1d6	+10 ft.
6th	33,600	6d6	+3	12	Monk	+3	2	2d4	+15 ft.
7th	67,200	7d6	+4	12	Canon	+3	2	2d4	+15 ft.
8th	130,000	8d6	+5	12	Prior	+4	2	2d4	+20 ft.
9th	260,000	9d6	+6	11	Abbot	+4	2	2d6	+20 ft.
10th	390,000	10d6	+6	11	Abbot	+5	2	2d6	+25 ft.
11th	520,000	+2 hp	+7	10	Abbot	+5	3	2d6	+30 ft.
12th	650,000	+2 hp	+8	10	Abbot	+6	3	3d4	+35 ft.
13th	780,000	+2 hp	+8	9	Abbot	+6	3	3d4	+40 ft.
14th	910,000	+2 hp	+9	9	Abbot	+7	3	3d4	+45 ft.
15th	1,040,000	+2 hp	+10	9	Abbot	+7	4	3d6	+50 ft.
16th	1,170,000	+2 hp	+10	8	Abbot	+8	4	3d6	+55 ft.
17th	1,300,000	+2 hp	+11	8	Abbot	+8	4	3d6	+60 ft.
18th	1,430,000	+2 hp	+12	7	Abbot	+9	4	4d4	+65 ft.
19th	1,560,000	+2 hp	+12	7	Abbot	+9	4	4d4	+70 ft.
20th	1,690,000	+2 hp	+13	6	Abbot	+10	4	4d6	+80 ft.

The TK should make sure that there is a rival monastery within 50 miles of the new monastery in order to provide opportunities for role-playing an adventure. The monasteries needn't be hostile towards one another, though they probably will be if they have opposite alignments. Rather, each is dedicated to proving itself better than the other in every possible way as part of its overall goal of self-perfection.

Possible Variations

Ninjas replace the monk's immunity from disease, quivering palm attack and the ability to speak with animals, plants, etc. with the thief ability to pick pockets and find/remove traps and the assassin abilities to don disguises, use poison (though not brew their own poisons) and backstab including the assassin's death attack. High level ninjas can establish secret mountain strongholds in the manner of assassins.

Ninjas must forever keep their identity secret, even from their closest comrades. They must always appear with their face shrouded or disguised. If a ninja's identity is revealed, she may no longer advance in level as a ninja unless they kill any and all who know their true identity.

Humans so dishonored can choose to dual class into another class, but demi-human ninjas have no such luck.

Ronins replace the monk's AC bonuses, increase in movement, various immunities, ability to speak with animals, plants and later all sentient creatures, and all of their skills except read languages, but gains the ability to wear any armor (though they do not use shields), with the monk's multiple attacks, stunning attack, deflect missiles ability and quivering palm attack when wielding a sword. Ronin also gain the riding ability of fighters. High level ronin can establish a stronghold in the manner of fighters.



The Paladin

Paladins are radiant men and women, sitting high in the saddle, a look of serenity on their faces, their armor shining and their clothes impeccable.

When they ride into town the good take heart and the wicked close their doors and count the moments before they must leave, for paladins are champions of Law and crusaders against Chaos.

Unlike most adventurers, paladins are bound to a strict code of virtue and honor, making them significantly less dangerous to peasants than the average treasure hunter.

Requirements & Restrictions

To be a paladin, a character must have the following minimum scores: Str 9 and Cha 15.

Paladins must be Lawful (LG) in alignment. They can use all armors, shields and weapons.

A paladin who ceases to be Lawful (LG) or whom grossly violates the paladin's code of conduct (see below), loses all special abilities, including the services of their mount.

The fallen paladin may not progress any further in levels as a paladin until he atones by gaining enough experience to gain another level without the use of his special abilities and while acting in perfect accordance with his alignment and code of conduct.

Paladin Skills

Paladins add their level to the following task checks:

Riding—Paladins are capable of attack from horseback at no penalty, and can use this task for dangerous stunts.

Paladin Abilities

A paladin can *detect evil* within 60' (as the spell) as long as he is concentrating. They are immune to disease, and can *cure disease* once per week per 5 levels attained.

Three times per day, a paladin can smite a Chaotic creature with a melee attack. If successful, the attack deals +1d6 damage. If the attack is against a Chaotic outsider, the attack deals +2d6 damage.

Paladins are surrounded by a halo of heavenly light. If the paladin has committed no wicked acts, the halo provides the equivalent of the *daylight* spell and *protection from evil* in a 10' radius.



If the paladin has been slightly less than pure (he has told a white lie, for example), the halo provides the equivalent of the *light* spell and *protection from evil* in a 5' radius. The paladin can suppress the effects of his halo whenever he wishes.

When a paladin completes his training and becomes 1st level, he is awarded a pair of silver spurs. These spurs provide the paladin a +1 reaction bonus and grant him entry into all tournaments. A 3rd level paladin is awarded the right to wear a religious badge on his surcoat. A paladin with spurs and a badge gets a +2 reaction reaction and admission into noble courts and Lawful temples. A 6th level paladin earns the right to bear a coat-of-arms, increasing his reaction bonus to +3 and giving him access to royal courts.

A 2nd level paladin can heal wounds (his own or those of others) by touch. This is called the "laying on of hands". Each day he can heal a total number of hit points of damage equal to twice his paladin level. He may choose to divide his healing among multiple recipients and he does not have to use it all at once.

A 3rd level paladin gains the ability to turn undead as a cleric two levels lower.

Paladin Advancement Table

Level	Experience Points	Hit Dice	Attack Bonus	Saving Throw	Title	Spells per Day per Spell Level			
						1st	2nd	3rd	4th
1st	0	1d8	+1	16	Squire	-	-	-	-
2nd	2,500	2d8	+2	15	Scutifer	-	-	-	-
3rd	5,000	3d8	+3	15	Banneret	-	-	-	-
4th	10,000	4d8	+3	14	Gallant	-	-	-	-
5th	20,000	5d8	+4	14	Companion	-	-	-	-
6th	40,000	6d8	+5	13	Knight	1	-	-	-
7th	80,000	7d8	+6	13	Paragon	1	-	-	-
8th	150,000	8d8	+6	12	Peer	1	-	-	-
9th	300,000	9d8	+7	12	Paladin	1	-	-	-
10th	450,000	10d8	+8	11	Paladin	1	1	-	-
11th	600,000	+3 hp	+9	11	Paladin	1	1	-	-
12th	750,000	+3 hp	+9	10	Paladin	1	1	1	-
13th	900,000	+3 hp	+10	10	Paladin	1	1	1	-
14th	1,050,000	+3 hp	+11	9	Paladin	2	1	1	-
15th	1,200,000	+3 hp	+12	9	Paladin	2	2	1	1
16th	1,350,000	+3 hp	+12	8	Paladin	2	2	2	1
17th	1,500,000	+3 hp	+13	8	Paladin	2	2	2	1
18th	1,650,000	+3 hp	+14	7	Paladin	3	2	2	1
19th	1,800,000	+3 hp	+15	7	Paladin	3	3	3	2
20th	1,950,000	+3 hp	+15	6	Paladin	3	3	3	3

A 4th level paladin can undertake a quest guided by a divine vision to find and gain the service of an unusually intelligent, strong, and loyal steed to serve him in his crusade against evil. This mount is a heavy warhorse or, for a small-sized paladin, a pony. The mount and its location appear in a vision. The location is no more than a week's ride away, and the challenge involved in claiming it should be difficult but not impossible.

Paladin's Warhorse, Large Monster: HD 6; AC 15; ATK 2 Kicks 1d6; MV 60'; SV 14; INT Low; AL Lawful (LG); XP 600 (CL 7); Special—Empathic link.

Paladin's War Pony, Medium Monster: HD 4; AC 14; ATK 2 Kicks 1d3; MV 50'; SV 15; INT Low; AL Lawful (LG); XP 400 (CL 5); Special—Empathic link.

For every three levels the paladin gains after 4th level, his mount gains one Hit Dice.

The mount serves loyally for 10 years, at which point it is retired and the paladin must call for a new warhorse.

A 6th level paladin learns to cast divine spells as a cleric, choosing his spells from the cleric spell list. The paladin must read from his canon and pray each morning to prepare his spells for the day. He can only prepare basic cleric spells, not advanced.

A paladin wielding a *holy avenger* sword can *dispel magic* up to three times per day.

Swearing Fealty

A 9th level paladin can swear fealty to a Lawful king or queen or to a religious order. The paladin is charged to reclaim holy relics that have been lost. To aid him on his quest, the paladin gains the services of a 5th level paladin as his squire, a 3rd level fighter as his shield-bearer, and a 0 HD page to act as his servant and groom. Use the henchman table (q.v.) to determine their race.

Strongholds

A 12th level paladin may conquer an evil stronghold and sanctify it for his own use in the manner of Sir Lancelot and his *Joyous Garde*. When a paladin conquers a castle, he attracts eight questing Lawful knights (paladins or fighters, roll 1d6+1 for level) as well as 60 Lawful men-at-arms of a type determined by the paladin.

Paladin Codes

Paladins live their lives by a code of virtue, and must also abide the following strictures:

- May not own more than 10 magic items.

- May not retain more wealth than needed to support himself, his henchmen and to maintain his castle.
- Must give 10% of his treasure to a Lawful church.
- May only employ Lawful henchmen. Paladins may adventure with non-Lawful characters, but must make at least a small attempt to reform them.

Besides these rules, paladins must abide by a code of virtuous conduct without fail. You can design a code of virtue yourself (with your TK's approval), or use one of the sample codes below, the chivalric code of Medieval Europe, and the bushido code of Japan.

	Bushido Code	Chivalric Code
I	Rectitude	Courage
II	Courage	Justice
III	Benevolence	Mercy
IV	Respect	Generosity
V	Honesty	Faith
VI	Honor	Valor
VII	Loyalty	Hope
VIII	Filial piety	Diligence
IX	Wisdom	Integrity
X	Care for the aged	Humility

Possible Variation

Antipaladins replace any ability of the paladin that works against Chaos with an ability that works against Law. Their lay on hands ability deals damage and they cause disease instead of curing it. Like paladins, they may not own more than 10 magic items, must tithe to a Chaotic church and must obey a code of vices.



The Ranger

Rangers are rough-hewn warriors of the wilderness, trained from an early age to hunt and survive. Being goodly folk, they use their skills as the defenders of civilization against the depredations of barbarians and monsters. Like druids, they prefer living rough in the greenwood to sleeping in a town or city.

Requirements & Restrictions

To become a ranger, a character must have the following minimum scores: Str 9, Wis 13 and Con 15.

Rangers must be Lawful in alignment. They can use all armors, shields and weapons.

Ranger Skills

Rangers add their level to the following task checks:

Handle Animal—Rangers can calm, domesticate and train animals.

Hear Noise—Rangers can hear incredibly quiet noises through doors or from far away.

Move Silently—Rangers can walk slowly without making a sound if they are not in metal armor.

Set Snares—Rangers can set entangling snares in the wilderness and in dungeons.

Survival—Rangers are skilled at survival. A 1st level ranger should select a home environment. In this environment, the ranger can find shelter, build a fire and find enough food and water for a 1d6 + his level people per day, with a only a 10% chance of failure. In unfamiliar environments, roll a task check.

Tracking—Rangers can follow tracks in the wilderness and in the dungeon. In the wilderness, he adds +10 to his task check. Penalties can be assessed for the passage of time or the action of the elements. Rangers can leave no tracks when operating alone by making a task check.

Ranger Abilities

Rangers are only surprised on a roll of 1 on 1d6.

Rangers deal extra damage equal to his level to Chaotic humanoids and giants. They also gain a +2 bonus to track those creatures. At 4th level, a ranger extends these bonuses to one additional monster type (such as aberration or undead) chosen by the player.

Ranger Advancement Table

Level	Experience Points	Hit Dice	Attack Bonus	Saving Throw	Title	Spells per Day per Spell Level			
						1st	2nd	3rd	4th
1st	0	2d8	+1	17	Woodsmen	-	-	-	-
2nd	2,500	3d8	+2	16	Scout	-	-	-	-
3rd	5,000	4d8	+3	16	Guide	-	-	-	-
4th	10,000	5d8	+3	15	Wanderer	-	-	-	-
5th	20,000	6d8	+4	15	Voyager	-	-	-	-
6th	40,000	7d8	+5	14	Pathfinder	1	-	-	-
7th	80,000	8d8	+6	14	Warden	1	-	-	-
8th	150,000	9d8	+6	13	Hawkeye	1	-	-	-
9th	300,000	10d8	+7	13	Ranger Lord	1	-	-	-
10th	450,000	+3 hp	+8	12	Ranger Lord	1	1	-	-
11th	600,000	+3 hp	+9	12	Ranger Lord	1	1	-	-
12th	750,000	+3 hp	+9	11	Ranger Lord	1	1	1	-
13th	900,000	+3 hp	+10	11	Ranger Lord	1	1	1	-
14th	1,050,000	+3 hp	+11	10	Ranger Lord	2	1	1	-
15th	1,200,000	+3 hp	+12	10	Ranger Lord	2	2	1	1
16th	1,350,000	+3 hp	+12	9	Ranger Lord	2	2	2	1
17th	1,500,000	+3 hp	+13	9	Ranger Lord	2	2	2	1
18th	1,650,000	+3 hp	+14	8	Ranger Lord	3	2	2	1
19th	1,800,000	+3 hp	+15	8	Ranger Lord	3	3	3	2
20th	1,950,000	+3 hp	+15	7	Ranger Lord	3	3	3	3

A 4th level ranger gains the servant of a special hunting beast. If an animal, the hunting beast is sentient (roll 3d4 for the animal's intelligence) and willful.

d10 Hunting Beast

1	Badger
2	Blink dog
3	Falcon
4	Giant spider
5	Leopard
6	Monitor lizard
7	Pseudodragon
8	Raven
9	Weasels (2)
10	Wolf

This hunting beast is a boon companion to the ranger, sticking with him through thick and thin. At 7th, 10th, 13th, 16th, and 19th level the hunting beast gains one Hit Dice.

A 6th level ranger learns to cast divine spells using the same rules as a druid. The ranger draws these spells from the druid spell list.

A 7th level ranger may move through any sort of undergrowth at his normal movement rate and without taking damage or suffering any impairment.

A 9th level ranger can use *crystal balls* as though he was a magic-user.



Ranger Bands

A 10th level ranger attracts a ranger band of 2d12 followers. These followers are very loyal to the ranger, and will not leave his service unless he ceases being a ranger. Members of a band that die are not replaced.

For each follower who joins the ranger's band, roll d% to determine what they are.

d%	Follower
01-16	1d4+1 men-at-arms (archers)
17-26	Cleric (roll 1d4+1 for level)
27-31	Druid (roll 1d4+1 level)
32-61	Fighter (roll 1d4+1 level)
62-64	Fighter/magic-user (roll 1d4+1 level)
65-94	Ranger (roll 1d4+1 for level)
95-99	Thief (roll 1d4+1 for level)
00	Extraordinary follower (roll on table below)

d20	Follower	d20	Follower
1-3	Badger, giant	13	Leprechaun
4-6	Bear, black	14	Owl, giant
7	Brownie	15	Owlbear
8	Centaur	16	Pegasus
9	Eagle, giant	17	Pixie
10	Grig	18	Satyr
11	Lynx, giant	19	Sprite
12	Hippogriff	20	Werebear

Possible Variations

Mariners replace tracking with navigation, set snares with climb walls, and deals extra damage to aquatic humanoids and later to aquatic monsters of all kinds.

Wizard-hunters can only wear up to chainmail armor and prepares magic-user spells instead of druid spells. The wizard-hunter cannot cast these spells, but can use them to counter-spell. The wizard-hunter scores extra damage against magic-users and sorcerers instead of against Chaotic humanoids. His followers are all men-at-arms and his extraordinary followers are all wizard-hunters with 1d4+1 levels each.



The Sorcerer

Sorcerers are born with magic in their blood. Perhaps they have a distant ancestor that hailed from another plane, or maybe they are the reincarnation of an Atlantean wizard. Sorcerers often have strange, troubled lives. Their powers manifest themselves in childhood, in ways they may not understand and almost certainly cannot control. This might have made them outcasts, or perhaps made them drunk on their own power.

Whatever a sorcerer's history, their powers tend to make them arrogant and give them a feeling of superiority over others. The lack of structure and tutelage that mark a sorcerer's training make them less predictable than the average magic-user.

Requirements & Restrictions

Sorcerer characters must have a charisma score of 9 or higher and they may not be Lawful. They may not wear armor or use shields, and fight with clubs, daggers, darts, crossbows (hand and light) and staves.

Sorcerer Skills

Alchemy—Sorcerers have a natural ability to identify chemicals and alchemical paraphernalia.

Sorcerer Abilities

Sorcerers can brew potions at 1st level.

Their natural tie to magic gives sorcerers the ability to sense the subtle ethereal vibrations of magic. When within 60' of magic, sorcerers get a weird tingling in

their minds, though they do not know where the magic is, or what it is until they cast the necessary divinations.

A sorcerer casts spells drawn from the magic-user spell list (see above). She makes no distinction between basic and advanced spells. A sorcerer can cast any spell she knows without preparing it ahead of time. Like other spell casters, a sorcerer can cast only a certain number of spells of each spell level per day. Her base daily spell allotment is given below.

A sorcerer begins play knowing two 1st-level spells. At each new sorcerer level, she gains new spells, as indicated on the table below. The sorcerer cannot use spell research to learn spells at a faster rate than normal, although she can still use research to invent new spells.

Sorcerer Spells Known

Level	1st	2nd	3rd	4th	5th	6th	7th	8th	9th
1	3	-	-	-	-	-	-	-	-
2	4	-	-	-	-	-	-	-	-
3	5	-	-	-	-	-	-	-	-
4	6	3	-	-	-	-	-	-	-
5	6	4	-	-	-	-	-	-	-
6	6	5	3	-	-	-	-	-	-
7	6	6	4	-	-	-	-	-	-
8	6	6	5	3	-	-	-	-	-
9	6	6	6	4	-	-	-	-	-
10	6	6	6	5	3	-	-	-	-
11	6	6	6	6	4	-	-	-	-
12	6	6	6	6	5	3	-	-	-
13	6	6	6	6	6	4	-	-	-
14	6	6	6	6	6	5	3	-	-
15	6	6	6	6	6	6	4	-	-
16	6	6	6	6	6	6	5	3	-
17	6	6	6	6	6	6	6	4	-
18	6	6	6	6	6	6	6	5	3
19	6	6	6	6	6	6	6	6	4
20	6	6	6	6	6	6	6	6	6

Sorcerers can attempt a dangerous procedure called impromptu casting to cast spells they do not know. The sorcerer must use a spell per day of that level to perform an impromptu casting.

To perform an impromptu casting, the sorcerer has a target number equal to her Charisma minus the level of the spell. She must roll the target number or lower on 1d20 to succeed at her impromptu casting.

If she does roll the target number or lower, the spell is cast normally. If not, she suffers a consequence based on

how badly she failed her roll. Subtract the target number from the roll and consult the chart below.

Fail by ...	Effect
1	Spell is cast, but is delayed for 1 round per spell level
2	Spell is cast, but with all variables minimized
3	No effect
4	The spell is cast, but with the opposite effect or it strikes a random person instead of the intended target
5	A random outsider (see below) is <i>gated</i> in against its will and remains for 1d6 rounds; it may be angry
6-7	The sorcerer gains an eccentric habit or minor phobia
8-9	The sorcerer gains a grotesque physical feature
10	The sorcerer cannot cast spells for 1 turn per level of the failed impromptu spell
11	The sorcerer suffers 1 point of wisdom drain
12+	The sorcerer suffers 1 point of constitution drain

Sorcerous Retinues

Sorcerers are natural outcasts and wanderers. They rarely build towers as magic-users do, although they can if they wish. They do, however, begin gathering a coterie or cult of followers at 6th level. From 6th to 12th level, a sorcerer gains one new follower per level. These followers are rolled randomly. Followers are as loyal to the sorcerer as is possible for eccentrics. If a sorcerer's follower is lost, he or she is not replaced.

d%	Follower
01-30	3 bandits
31-50	2 cultists (adepts, level 1d3)
51-56	Assassin (1st level)
57-64	Barbarian (1st level)
65-86	Fighter (1st level)
87-94	Sorcerer (roll 1d3 for level)
95-99	Thief (1st level)
00	Extraordinary follower

d%	Extraordinary Follower
01-30	Giant rat or cat (intelligent)
31-50	Tiefling
51-70	Pixie or sprite
71-89	Familiar (see <i>find familiar</i> spell) ***
90-94	Imp or quasit
95-97	Wyrmling (metallic if Neutral, chromatic if Chaotic)
98-99	Small elemental *
00	Incubus or succubus **

Sorcerer Advancement Table

Level	Experience Points	Hit Dice	Attack Bonus	Saving Throw	Title	Spells per Day per Spells Level								
						1	2	3	4	5	6	7	8	9
1st	0	1d4	+0	15	Prodigy	2	-	-	-	-	-	-	-	-
2nd	2,000	2d4	+0	14	Curiosity	3	-	-	-	-	-	-	-	-
3rd	4,000	3d4	+1	14	Freak	4	-	-	-	-	-	-	-	-
4th	8,000	4d4	+1	14	Spectacle	4	1	-	-	-	-	-	-	-
5th	16,000	5d4	+1	13	Whiz	4	2	-	-	-	-	-	-	-
6th	32,000	6d4	+2	13	Wonder	4	2	1	-	-	-	-	-	-
7th	64,000	7d4	+2	12	Phenomenon	5	3	2	-	-	-	-	-	-
8th	128,000	8d4	+3	12	Warlock/Witch	5	3	2	1	-	-	-	-	-
9th	260,000	9d4	+3	12	Sorcerer	5	4	3	2	-	-	-	-	-
10th	380,000	10d4	+3	11	Sorcerer	5	4	3	2	1	-	-	-	-
11th	500,000	+1 hp	+4	11	Sorcerer	5	5	4	3	2	-	-	-	-
12th	620,000	+1 hp	+4	11	Sorcerer	5	5	4	3	2	1	-	-	-
13th	740,000	+1 hp	+5	10	Sorcerer	5	5	4	4	3	2	-	-	-
14th	860,000	+1 hp	+5	10	Sorcerer	5	5	4	4	3	2	1	-	-
15th	980,000	+1 hp	+5	10	Sorcerer	5	5	4	4	4	3	2	-	-
16th	1,100,000	+1 hp	+6	9	Sorcerer	5	5	4	4	4	3	2	1	-
17th	1,220,000	+1 hp	+6	9	Sorcerer	5	5	4	4	4	3	3	2	-
18th	1,340,000	+1 hp	+7	9	Sorcerer	5	5	4	4	4	3	3	2	1
19th	1,460,000	+1 hp	+7	8	Sorcerer	5	5	4	4	4	3	3	3	2
20th	1,580,000	+1 hp	+7	8	Sorcerer	5	5	4	4	4	3	3	3	3

* *Elementals are kept in a special container until needed. Fire elementals might be in lanterns, water elementals in flasks, etc.*

** *The succubus or incubus is an on-again/off-again love interest. They appear at difficult times, and the sorcerer has a 2% chance per level to summon them. They remain until bored or threatened.*

*** *A sorcerer is only allowed one familiar.*

Sorcerer Bloodlines

A player might want to emphasize the magical bloodline of her sorcerer. Sorcerers using these bloodline rules are not necessarily more powerful than those who do not.

Demon: Demonic sorcerers enjoys a +1 bonus to save vs. electricity damage. When demons are encountered, 1 in 6 is kin to the sorcerer and behaves in a friendly manner to her. The sorcerer increases the target number to cast impromptu conjuration spells by +2, but they cannot cast spells that deal fire damage or involve fire.

Devil: A diabolic sorcerers enjoys a +1 bonus to save vs. fire damage. When devils are encountered, 1 in 6 is kin to the sorcerer and behaves in a friendly manner to her. The sorcerer increases the target number to cast impromptu enchantment spells by +1, but they cannot cast electricity spells.

Elemental: Elemental sorcerers are descended from genies. They are +1 to save vs. fear. When genies are encountered, 1 in 6 is kin to the sorcerer and behaves in a friendly manner to her. The sorcerer increases the target number to cast impromptu evocation spells by +1, but they cannot cast abjuration spells.

Dragon: Sorcerers descended from dragons are +1 to save vs. sleep and charm spells. When dragons are encountered, 1 in 6 is kin to the sorcerer and behaves in a friendly manner to her. The sorcerer increases the target number to cast divination spells by +1, but they cannot learn conjuration spells.

Fey: Sorcerers descended from the fey, or children fed on nursed by fairies or fed on fairy fruits, enjoy a +1 bonus to save vs. enchantment and illusion spells. When fey are encountered, 1 in 6 is kin to the sorcerer and behaves in a friendly manner to her. The sorcerer increases the target number to cast illusion spells by +1, but they cannot cast necromancy spells.

Hag: Sorcerers descended from hags enjoy a +1 bonus to save vs. enchantment and illusion spells. When hags and giants are encountered, 1 in 6 is kin to the sorcerer and behaves in a friendly manner to her. The sorcerer

increases the target number to cast necromancy spells by +1, but they cannot cast evocations.

Possible Variations

Chaos mages use the magic-user's "spells per day" chart instead of the sorcerers, but with each spell she casts, there is a cumulative percentage chance equal to the level of the spell she casts x 5% that the spell goes haywire. When this happens, consult the Wild Magic chart on page 184. When a spell finally does go haywire, the chance of another wild magic event is reset to 0%.

Prophets learn and cast their spells from the cleric spell list instead of magic-user spell list. In place of impromptu casting, they can turn undead. As with clerics, they must be Chaotic or Lawful in alignment.

Warlocks lose one daily spell cast per day per level and one spell known per level, but gain Hit Dice of 1d6 instead of 1d4, the ability to wear up to ring mail armor and use all shields, and the ability to use all weapons.



The Thief

Always have people sought a fraction more than they earned – an extra coin, an extra portion of grain. Like water, gold seeks the lowest ground. When one amasses a fortune, the thief becomes the conduit of its distribution into the wider world. Of course, the thief must survive, and so she keeps the lion's share of that coin for herself as a lesson to others of what might be achieved with honest graft. In a fantasy realm, there is no greater source of wealth than the dungeon, and so here comes the thief, to liberate that wealth.

Requirements & Restrictions

Thieves must have a dexterity score of 9 or higher. They cannot be Lawful in alignment. Thieves can use padded and leather armor and no shields. They can fight with clubs, crossbows, daggers, darts, javelins, maces, morningstars, punching daggers, quarterstaves, rapiers, saps, short bows, short swords, sickles, slings and spears.

Thief Skills

Climb Walls—Thieves can climb walls without climbing gear at a rate of 10' per round.

Find/Remove Traps—Thieves find traps automatically when they examine an object or room. This takes 10 minutes. Once a trap is found a thief can remove it with a task check. If this roll fails, the trap is set off.

Hear Noise—Thieves can hear incredibly quiet noises through doors or from far away.

Hide in Shadows—Thieves can disappear into the shadows and remain unseen, even while moving. A thief can backstab from the shadows.

Move Silently—Thieves can walk slowly without making a sound if they are not in metal armor.

Open Locks—Thieves can use their tools to open locks.

Pick Pockets—Thieves can pick pockets and perform small acts of legerdemain.

Read Languages—Thieves can decipher languages. After 9th level, a thief can use this ability to read magic-user scrolls and cast the spells therein.

Thief Advancement Table

Level	Experience Points	Hit Dice	Attack Bonus	Saving Throw	Backstab	Title
1st	0	1d6	+0	16	1d6	Scamp
2nd	1,500	2d6	+1	16	1d6	Varlet
3rd	3,000	3d6	+1	15	1d6	Villain
4th	6,000	4d6	+2	15	1d6	Dodger
5th	12,000	5d6	+2	15	2d6	Rapscallion
6th	24,000	6d6	+3	15	2d6	Desperado
7th	48,000	7d6	+4	14	2d6	Rook
8th	100,000	8d6	+4	14	2d6	Scoundrel
9th	200,000	9d6	+5	14	3d6	Master Thief
10th	300,000	10d6	+5	14	3d6	Master Thief
11th	400,000	+2 hp	+6	14	3d6	Master Thief
12th	500,000	+2 hp	+7	13	3d6	Master Thief
13th	600,000	+2 hp	+7	13	4d6	Master Thief
14th	700,000	+2 hp	+8	13	4d6	Master Thief
15th	800,000	+2 hp	+8	13	4d6	Master Thief
16th	900,000	+2 hp	+9	12	4d6	Master Thief
17th	1,000,000	+2 hp	+10	12	4d6	Master Thief
18th	1,100,000	+2 hp	+10	12	4d6	Master Thief
19th	1,200,000	+2 hp	+11	12	4d6	Master Thief
20th	1,300,000	+2 hp	+11	12	4d6	Master Thief

Thief Abilities

Thieves are dirty fighters. If a thief can manage to backstab an opponent she deals +1d6 damage. Backstab damage increases as the thief advances in level (see table above). Ranged attacks count as backstabs if the target is within 30 feet. Backstabs do not work on non-living creatures, such as the undead, or on creatures without vital organs, such as oozes and constructs.

A 6th level thief has enough of a reputation that they can hastily assemble a team of rogues for a caper. The thief can put the word out and within 24 hours gather 1d6+3 levels worth of thieves. These thieves expect normal pay and a share of treasure for the caper, and they may not be trustworthy (25% chance + 5% per charisma bonus).

Thieves' Den

A 9th level thief can choose to establish a den in the wilderness or in a settlement and gain followers. A thief with a wilderness den attracts 1d10 x 10 bandits or brigands, with normal leader types for those scoundrels.

A thief with a den in a settlement attracts 4d6 lower level thieves to his criminal guild. Roll the race of each thief randomly (see Henchmen). Use the following table to determine each thief's level:

d%	Thief Level
01-25	1st
26-50	2nd
51-70	3rd
71-85	4th
86-95	5th
96-00	6th

Possible Variations

Acrobats replace the thief's skill at picking pockets and reading languages with skill at acrobatics and the monk's reduced falling damage.

Scouts replace the thief's skill at picking pockets and reading languages with skill at riding and survival.



The Multi-class Option

Only non-humans can multi-class. A multi-classed character pursues two or three classes at the same time. To multi-class, a character must qualify for each class in terms of ability scores and alignment. A multi-class cleric must have Wisdom of 13 or higher. A multi-class fighter must have Strength of 13 or higher. A multi-class magic-user must have Intelligence of 13 or higher. A multi-class thief must have Dexterity of 13 or higher. A multi-class sorcerer must have Charisma of 13 or higher.

A multi-class character must earn a number of XP equal to the XP requirements of both classes to advance in level. A fighter/cleric, for example, must earn 4,300 XP (fighter's 2,000 + cleric's 2,300) to achieve 2nd level.

A multi-classed character has the following benefits and limitations:

- A multi-class character rolls both of their class's hit dice at each level and averages the two results for their gained hit points, adding their Con modifier to the total.
- A multi-class character uses the best attack bonus and saving throw value of their two classes.
- A multi-class character uses the more restrictive armor list of their two classes and the less restrictive weapon list of their two classes.
- A multi-class character gets all the special abilities of both classes.

The Dual-class Option

A human, half-elf or half-orc character might decide to switch class mid-play (though not in the middle of an adventure). When a character would normally gain a new level in his original class, he can choose instead to become 1st level in a new class. When this decision is made, the character stops accumulating XP in his old class and begins applying earned XP to his new class.

- A character can only change classes after achieving at least 3rd level in his original class.
- A dual-classed character does not earn new Hit Dice until he attains more levels in his new class than his old class. For example, a character who had attained 4th level as a bard could not earn new Hit Dice as a fighter until he advanced to 5th level as a fighter.
- A dual-class character uses the more restrictive armor list of their classes and the least restrictive weapon list.

- A dual-class character keeps the special abilities of his old class at the highest level to which he advanced, and gains the special abilities of his new class as he advances in level.

- A dual-class character uses the better saving throw values of his new class.

Feats (Optional Rule)

A feat is a minor ability or bonus that allows a player to personalize their character beyond the normal racial and class features. Some Treasure Keepers do not care for feats, so check with yours to see if they want to use feats and to discover which feats are permitted.

If feats are used, it is traditional for characters to choose one feat at 1st level, and then additional feats at 4th, 8th, 12th, 16th and 20th level. Again, check with your Treasure Keeper to see at which intervals they want characters to receive feats, as they may adjust their availability in their game.

Alertness: You are only surprised on a roll of 1 on 1d6.

Bull Rush: You get a +2 bonus to make bull rush attacks.

Cleave: When you drop an opponent to 0 or fewer hit points, you may make a second attack with the same weapon at the end of the combat round against any foe that is within reach.

Disarm: You get a +2 bonus to make disarm attacks.

Dodge: You improve your Armor Class by 1.

Enlarge Spell: You may double the range of one spell that you cast each day.

Expertise: You can accept a penalty of -2 to your attack rolls to gain a +2 bonus to your AC.

Extend Spell: You can cast one spell per day with double the normal duration.

Fast: You increase your movement by 10 feet.

Grapple: You get a +2 bonus to make grapple attacks.

Great Fortitude: +1 to save vs. poison and disease.

Iron Will: +1 bonus to save vs. fear and charm.

Lightning Reflexes: +1 bonus to save vs. breath weapons, rays and traps.



Magical Aptitude: You learn to cast a single non-damage dealing 1st level magic-user spell once per day. You may choose this feat more than once, applying it to a different spell each time. Any character can take this feat.

Overrun: You get a +2 bonus to make overrun attacks.

Power Attack: You can accept a penalty of -2 to your melee attack rolls and gain a +2 bonus to melee damage.

Precision: You can accept a penalty of -2 to your melee damage rolls and gain a +2 bonus to melee attacks.

Pugilist: Your unarmed attacks deal +1 point of damage.

Silent Spell: You can cast one spell each day without having to vocalize it.

Skill Focus: You gain a +3 bonus to perform a single type of non-combat task. You can take this feat multiple times, but each time it applies to a different task.

Still Spell: You can cast one spell per day without moving your hands.

Sunder: You get a +2 bonus to make sunder attacks.

Toughness: You gain +3 hit points.

Trip: You get a +2 bonus to make trip attacks.

Two-Weapon Defense: When wielding two weapons in combat, you gain a +1 bonus to AC if you sacrifice making an attack with your secondary weapon.

Two-Weapon Fighting: When attacking with two weapons, you only suffer a -1 penalty with the primary weapon and a -3 penalty with the secondary weapon.

Weapon Finesse: When wielding a light melee weapon, you can add your dexterity bonus to your attack roll in place of adding your strength bonus.

Weapon Focus: You gain a +1 bonus to attack with a chosen weapon. You can take this feat more than once, applying it to a different weapon each time.

Weapon Proficiency: You learn to use a weapon normally unavailable to your class. For example, a magic-user might learn to wield a longsword. A cleric's restriction against using edged or piercing weapons cannot be by-passed with this feat.

Widen Spell: Once per day, you can double the area of effect of a spell.

Alignment

An alignment is a combination of philosophy and cosmic faction. Members of the three major alignments, Law, Neutrality and Chaos, are hostile to one another, although not always violently. The minor alignments can be thought of as sects within the major alignment. The members can find themselves opposed, but for the most part work with another for the higher goal.

In a TK's campaign, she can choose to use only the three major alignments, or to use all nine alignments.

LAW, or Good, stands for the creation and order of the cosmos as well as the creativity and order of human civilization. Law is equated with virtuous behavior, and is represented by the angels, archons and celestials. On the Material Plane, it is represented by civilization and its agents and defenders, like paladins and clerics.

Lawful characters may not employ poison, flaming oil or alchemist's fire in combat, as it is against their moral code of fair play. They can expect free healing at Lawful temples, but they have to pay for healing from druids at the normal rate.

In a nine-fold alignment scheme, the Lawful alignment is divided into three alignment sects.

Lawful Good (LG) seeks justice and punishes evil.

Neutral Good (NG) is charitable and protects the weak.

Chaotic Good (CG) is into freedom and love.

NEUTRAL is a middle path between Law and Chaos that acknowledges the importance of both, but thinks that either is dangerous if taken to an extreme. Some neutrals ignore the pull between Law and Chaos, while others work to maintain a balance so that neither side can become too powerful.

Neutral characters do not use poison against sentient creatures, but they do use flaming oil and alchemist's fire. They must pay for healing from Lawful clerics at the normal rate, but not from druids.

In a nine-fold alignment scheme, the Neutral alignment is divided into three alignment sects.

Lawful Neutral (LN) believes in tradition and tranquility – don't make trouble!

Neutral (N) is pragmatic – not too good, not too evil.

True Neutral (TN) believes there must be a cosmic balance between the alignments.

Chaotic Neutral (CN) loves change for its own sake.

CHAOS, or Evil, stands for entropy and disorder. Chaos existed before the cosmos was ordered and those who adhere to it believe that Chaos will still exist when the ordered cosmos finally dies. Chaos is represented by the demons and devils. On the Material Plane, Chaos is represented by such enemies of civilization as monsters, berserkers, assassins and anti-clerics.

Chaotic characters may use poison, flaming oil and alchemist's fire in combat. They must pay double the normal rate for healing from Lawful clerics and the normal rate from druids.

In a nine-fold alignment scheme, the Evil alignment is divided into three alignment sects.

Lawful Evil (LE) craves power for its own sake.

Neutral Evil (NE) is corrupted by the love of money.

Chaotic Evil (CE) kills and destroys for fun.

Alignment Languages (Optional)

Each alignment has a secret language composed of signs, signals and phrases which sentient members of that alignment understand and can speak in addition to other languages known and regardless of their intelligence.

Alignment languages can be used to identify other members of an alignment and to communicate very simple messages without members of other alignments knowing that a message is being transmitted.

For example, a Chaotic thief might make it known to a band of goblins that, unlike the rest of the party, he is also Chaotic and that he might make it worth their while if they spare his life in the fight to come.

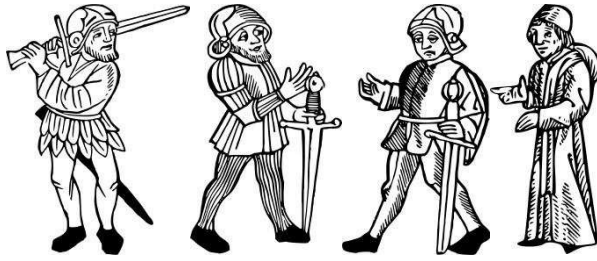

Heritage

Adventurers have one additional characteristic called heritage. This determines the situation of their birth and their starting money.

Humans, half-orcs and half-elves roll 3d6 for heritage

Dwarves, gnomes and halflings do not have slavery in their cultures, and nobility is rare among them (though dwarves do have kings and high kings), so they roll 4d4.

Elves roll 2d6+6 for heritage, as they have neither slaves nor serfs, but they do have nobility.

3d6	Heritage	Starting Money	Starting Clothes
3	Slave*	1d10 gp	Ragged
4-5	Serf	1d6 x 10 gp	Worn
6-8	Villein	2d6 x 10 gp	Utilitarian
9-12	Yeoman	3d6 x 10 gp	Simple
13-15	Burgher	4d6 x 10 gp	Fashionable
16-17	Gentry	5d6 x 10 gp	Refined
18	Noble	6d6 x 10 gp	Expensive

**You may rule that 1% of characters who roll a "3" for heritage have actually been drawn into the fantasy world from modern Earth. They will have 1d10 gp in starting money and their clothes will be modern.*

Once heritage is determined, a character can roll for a secondary skill that she might have learned from her parents. To determine a character's secondary skill, roll 1d12, add the character's heritage score, and consult the table on the next page.

Secondary skills are vague and open-ended by design. The Treasure Keeper alone rules when a task that a character is attempting comes under the influence of their secondary skill. When it does, the character gains a +1 bonus on their task check to perform that task. This bonus cannot be applied to attack rolls or saving throws.

Roll	Secondary Skill
4	Beggar
5	Poacher or rustler
6	Bandit
7	Bawd or prostitute
8	Smuggler or fence
9	Musician or poet
10	Fisherman
11	Hunter or trapper
12	Farmer or shepherd
13	Jailer or executioner
14	Tinker
15	Sailor
16	Soldier or watchman
17	Scribe or clerk
18	Trader
19	Cobbler or tailor
20	Mason or carpenter
21	Tanner or leatherworker
22	Bowyer or fletcher
23	Armorer or blacksmith
24	Jeweler or lapidary
25	Barber
26	Apothecary
27	Physician
28	Lawyer
29	Merchant
30	Courtier



Equipment

3

Once characters have been created, they must be equipped to survive the dangers of dungeons and the wilderness.

Money

The most common coin in the game is the gold piece (gp). A gold piece is worth 10 silver pieces (sp). Each silver piece is worth 10 copper pieces (cp). In addition to these coins, there are also platinum pieces (pp), which are each worth 10 gp, and electrum pieces (ep), which are worth 5 sp. The standard coin weighs about half an ounce, so there are roughly 30 coins to the pound. Coffers and chests hold roughly 10 coins per square inch.



The coin above is presented actual size. It is as thin as a modern U.S. dime.

Merchants commonly exchange trade goods without using currency. Some trade goods are detailed below.

Item	Value
1 lb. of wheat or hay	1 cp
1 lb. of flour or 1 chicken	2 cp
1 lb. of iron or 1 goose	1 sp
1 lb. of tobacco or wool	5 sp
1 lb. of cinnamon or 1 goat	1 gp
1 lb. of ginger or pepper or 1 sheep	2 gp
1 pig	3 gp
1 square yard of linen	4 gp
1 lb. of salt	5 gp
1 square yard of silk or 1 cow	10 gp
1 lb. of saffron or cloves or 1 ox	15 gp

Selling Loot

A character can sell loot for half its listed price. Trade goods are the exception to the half-price rule. A trade good is a valuable good that can be exchanged as if it

were money. Treasure Keepers might want to introduce a random element to these values, perhaps rolling 1d6 and cutting a price or value in half on a roll of "1", and doubling it on a roll of "6".

Melee Weapons

Melee weapons are designed to be used in hand-to-hand combat, or *melee*. Technically, all melee weapons can be thrown as ranged weapons, but only a few, the throwing axe and dagger in particular, do this well.

Small creatures wield light weapons one-handed and medium weapons two-handed. They cannot wield large weapons. Medium creatures wield light and medium weapons one-handed, and large weapons two-handed. Large creatures wield all weapons one-handed. Despite their small stature, dwarves are counted as medium creatures for the purpose of wielding weapons

Weapon Notes

Billhook: Billhooks were often employed by peasants, as they were adapted from farm implements.

Dagger: The basic dagger has a foot-long blade.

Dagger, Punching: These weapons are also called kataras or push daggers.

Gauntlet: Suits of platemail and plate armor come with gauntlets. Gauntlets can also be spiked.

Greatsword: Greatswords are long, two-handed swords that require significant strength and practice to use properly. One hand is usually kept on the lower portion of the blade, which is not sharp, to allow the weapon to block attacks as well as make them.

Kukri: Kukris can be used to represent any curved knife, like the khanjar and jambiya.

Mace: A mace is a club tipped with a heavy, metal head. Maces do not have spiked heads (those are morningstars), but they can be flanged. The horseman's mace has a longer haft and a smaller head so that it can be used from horseback without unbalancing a knight.

Manriki-Gusari: This weapon's name means "ten-thousand-power-chain" in Japanese. Awesome!

Morningstar: Morningstars are spiked maces. Because they are spiked, they cannot be employed by clerics.

Pike: The pike can be used to attack from the second or third rank during combat.

Light Melee Weapons

Weapon	Cost	Damage	Range	Length	Weight	Notes
Axes						
Axe, archer's	3 gp	1d6	—	20"	1.5 lb.	—
Axe, horseman's	6 gp	1d6+1	—	25"	2.5 lb.	—
Francisca	8 gp	1d6+1	20/40	19"	2.0 lb.	—
Handaxe	5 gp	1d6	15/30	21"	1.5 lb.	—
Cat-o'-nine-tails	2 gp	1d3	—	30"	0.8 lb.	+1 to disarm attacks
Clubs						
Club	2 gp	1d3	20/40	24"	3 lb.	—
Tonfa	6 sp	1d2	—	23"	1 lb.	Usually wielded in pairs
Daggers						
Curved dagger	2 gp	1d4	—	14"	1 lb.	—
Dagger	2 gp	1d4	20/40	15"	1 lb.	—
Knife	1 gp	1d3	15/30	7"	0.5 lb.	—
Kukri	3 gp	1d4+1	—	18"	1.5 lb.	—
Punching dagger	3 gp	1d6	—	21"	1.5 lb.	—
Main gauche	3 gp	1d6	—	20"	1.5 lb.	Can be used as a buckler
Stiletto	1 gp	1d3	—	14"	0.5 lb.	+1 to attack vs. mail and leather armors
Sword-breaker	5 gp	1d6	—	20"	2 lb.	+2 to sunder attacks
Wavy-bladed dagger	2 gp	1d4+1	—	12"	1 lb.	—
Gauntlets						
Gauntlet	4 sp	1d3	—	—	1.5 lb.	—
Gauntlet, spiked	6 sp	1d3+1	—	—	1.5 lb.	—
Hammer						
Hammer, horseman's	1 gp	1d3	—	23"	2.5 lb.	—
Hammer, throwing	2 gp	1d3	20/40	23"	2 lb.	—
Jitte	2 gp	1d3	—	18"	0.7 lb.	+2 to disarm attacks
Kama	6 gp	1d6+1	—	20"	2 lb.	+2 to disarm attacks
Mace, horseman's	3 gp	1d4+1	—	23"	2.5 lb.	—
Manriki-gusari	6 gp	1d4	—	48"	0.5 lb.	Ignores bucklers
Nunchaku	8 sp	1d3	—	13"	0.5 lb.	Ignores bucklers
Sai	3 gp	1d4	10/30	19"	1 lb.	+2 to disarm attacks
Sap	6 sp	+1	—	8"	0.5 lb.	—
Sickle	1 gp	1d4	—	8"	0.8 lb.	—
Staff	6 gp	1d3+1	—	70"	1.5 lb.	—
Staff, short	3 gp	1d3	—	50"	1 lb.	—
Sword, short	6 gp	1d6	—	26"	1.5 lb.	—
Backsword	6 gp	1d6	—	24"	1.5 lb.	—
Cinquedea	5 gp	1d6+1	—	24"	2.5 lb.	—
Cutlass	8 gp	1d6+1	—	25"	2 lb.	—
Falchion	9 gp	1d6+1	—	32"	2 lb.	—
Scimitar	6 gp	1d6	—	33"	1.5 lb.	—

Medium Melee Weapons

Weapon	Cost	Damage	Range	Length	Weight	Notes
Axe						
Battleaxe	11 gp	1d8	—	36"	4.5 lb.	+1 damage with two hands
Bearded axe	8 gp	1d6+1	—	24"	2.5 lb.	+1 damage with two hands
Flail						
Flail, horseman's	5 gp	1d4	—	39"	3 lb.	Ignores bucklers
Kusarigama	6 gp	1d6+1	—	18"	2.5 lb.	Ignores bucklers
Three-section-staff	9 gp	1d4	—	82"	4 lb.	Ignores bucklers and shields
Hammer, footman's	8 gp	1d4	—	60"	4 lb.	+1 to attack vs. mail armors
Lance, light	18 gp	1d8	—	108"	3.5 lb.	+1d6 damage on charge
Mace, footman's	6 gp	1d6	—	24"	3.5 lb.	+1 to attack vs. all armor
Morningstar	2 gp	1d4	—	22"	3 lb.	—
Pick, horseman's	8 gp	1d6+1	—	24"	3 lb.	+1 to attack vs. mail and leather armor
Spear †	15 gp	1d8	15/30	70"	3.5 lb.	+1 damage with two hands
Sword						
Bastard sword	12 gp	1d8	—	40"	3.5 lb.	+1 damage with two hands
Broadsword	9 gp	1d6+1	—	35"	3 lb.	+1 save against disarm
Estoc (tuck)	12 gp	1d8	—	42"	3.5 lb.	+1 to attack vs. mail and leather armor
Executioner's sword	12 gp	2d4	—	32"	4.5 lb.	+1 damage with two hands
Katar	9 gp	1d6+1	—	40"	2.5 lb.	—
Longsword	11 gp	1d8	—	42"	4 lb.	—
Rapier	9 gp	1d6+1	—	41"	2.5 lb.	—
Saber	9 gp	1d6+1	—	38"	3 lb.	—
Tulwar	8 gp	1d6	—	35"	2.5 lb.	—
Trident	12 gp	1d6+1	—	72"	4 lb.	+1 damage with two hands
Whip	1 gp	1d4+1	—	99"	3 lb.	+1 to disarm and trip, ignore bucklers

Quarterstaff: The quarterstaff is a stout, 8 foot-long wooden pole tipped with iron.

Ranseur: Also called the runkah, they are used to hold enemies at bay and to pull knights from their mounts.

Rapier: The rapier category also includes the medieval arming sword and the later side-sword and small sword.

Sap: A sap is also called a blackjack.

Scimitar: Scimitars are curved, slashing blades usually employed from horseback. The saber is a derivation. The Japanese *katana* is a slashing sword similar to the scimitar, though often a bit longer.

Scythe: Although it is not really as a combat weapon, the scythe's association with the Grim Reaper has made it a favorite of anti-clerics.

Spear: Maybe the next most ancient weapon after the club, the spear was the mainstay of armies until the introduction of muskets and bayonets.

Sword, Bastard: Also called hand-and-a-half swords, they have longer blades than longswords and can be wielded with one or two hands. When wielding one-handed, the sword inflicts 1d8 points of damage. When wielded two-handed, it inflicts 1d8+1 points of damage.

Trident: Tridents are typically used for catching fish, but they saw some use in combat by gladiators.

Warhammer: Warhammers typically have two faces, one blunt and the other spiked. If clerics promise not to use the spiked side, they can use warhammers in battle.

Melee Weapons – Heavy

Weapon	Cost	Damage	Range	Length	Weight	Notes
Club, heavy	8 gp	1d4+1	—	47"	5.5 lb.	+1 to attack vs. all armors
Flail, footman's	9 gp	1d4	—	63"	5.5 lb.	Ignores bucklers and shields
Greatsword	25 gp	1d10	—	66"	8 lb.	—
Holy water sprinkler	14 gp	1d8	—	75"	5 lb.	—
Lance, heavy	20 gp	2d4	—	134"	6 lb.	+1d6 damage on charge
Polearms						
Ahlspiess †	12 gp	2d4	—	43"	6.5 lb.	+1 to attack vs. leather and mail armors
Bardiche	12 gp	1d8	—	65"	4 lb.	—
Bec-de-corbin	8 gp	1d4+1	—	68"	5.5 lb.	+1 to attack vs. all armors
Billhook	20 gp	1d8	—	90"	4.0 lb.	+2 to trip attacks
Bohemian ear spoon †	20 gp	1d8	—	106"	5.5 lb.	—
Brandistock †	14 gp	1d8	—	67"	4 lb.	+1 to attack vs. leather and mail armors
Fauchard †	20 gp	2d4	—	84"	6.5 lb.	+2 to trip attacks
Glaive	21 gp	1d10	—	102"	7.5 lb.	—
Guisarme †	17 gp	2d4	—	70"	6.5 lb.	+2 to trip attacks
Halberd †	18 gp	2d4	—	92"	6.5 lb.	—
Lucerne Hammer	17 gp	1d6	—	114"	7.5 lb.	+1 to attack vs. all armors
Military fork †	18 gp	2d4	—	97"	6 lb.	+2 to disarm attacks
Partisan †	20 gp	2d4	—	103"	4.5 lb.	—
Pike †	30 gp	1d10	—	300"	13 lb.	+1 to attack vs. leather and mail armors
Poleaxe	14 gp	2d4	—	60"	5 lb.	—
Ranseur †	17 gp	1d10	—	66"	9 lb.	—
Scorpion †	20 gp	1d8	—	90"	6 lb.	+2 to trip attacks
Spetum †	18 gp	2d4	—	90"	5 lb.	—
Spontoon †	17 gp	1d8	—	76"	3.5 lb.	—
Voulge	15 gp	2d4	—	83"	6 lb.	—
Quarterstaff	14 gp	1d6	—	104"	3.5 lb.	—
Scythe	10 gp	2d4	—	67"	4.5 lb.	Devastating against wheat
Warhammer	12 gp	1d4+1	—	48"	5.5 lb.	+1 to attack vs. leather and mail armors

† Weapon does an extra dice of damage when set to receive a charge

Whip: Whips are melee weapons that act as ranged weapons, using the attacker's Dexterity modifier rather than Strength modifier on the attack roll.

Ranged Weapons

Range is given in two numbers. The first represents the weapons effective range, the second its maximum range. When shooting at a target within the effective range of a weapon the shooter suffers no penalty. When shooting at a target that is between effective and maximum range, the shooter suffers a -4 penalty to their attack roll. Range is in feet indoors, and in yards outdoors.

The "Attacks" column shows the maximum number of attacks that can be made with the weapon during a round, assuming its wielder can make multiple attacks.

Strength is the strength score required to use the weapon effectively.

Bows

A bow is a length of wood curved by affixing a shorter string between the ends of the wood and is differentiated by size. Small creatures can use composite and short bows, and both of those weapons can be used while

mounted. Longbows can only be used by medium and large creatures with a strength score of 13 or higher.

Crossbows

Crossbows place a traditional bow on a wooden or metal stock, allowing them to be shot in the manner of a gun. Hand crossbows resemble pistols. Siege crossbows and heavy crossbows require a windlass or cranequin to set and load, and thus have a lower rate of fire.

Repeating crossbows are an invention of the Chinese, and thus might only be available in Asian settings at the TK's discretion. They have a magazine of 10 bolts and reload as they fire. When the magazine is depleted, it takes one turn to replace it.

Hand, light and repeating crossbows can be used by small creatures. Heavy crossbows can be used by medium and large creatures. Siege crossbows can be operated by two medium or a single large creature.

Gunpowder Weapons

Gunpowder weapons appeared during the Middle Ages and began to dominate warfare during the Renaissance. They are available in the game at the Treasure Keeper's discretion. Pistols can be wielded by small creatures, arquebuses by medium creatures or small creatures using a pronged staff, and handgonnes and muskets by large creatures or medium creatures using a staff.

Ammunition

Ammunition	Cost	Weight
Arrows (for bows), quiver of 20	1 gp	3 lb.
Bolts (for crossbows), case of 10	2 gp	1 lb.
Bullets (for slings), sack of 20	1 sp	1 lb.
Shot (for guns), magazine of 10	3 gp	1 lb.

Ranged Weapons

Weapon	Cost	Damage	Attacks	Range	Strength	Weight
Blowgun	1 sp	1d4	1	60/100	-	1 lb.
Bolas	5 gp	1d4 + entangle	1	40/240	-	2 lb.
Dart	5 sp	1d6	2	30/70	-	½ lb.
Javelin	1 gp	1d8	1	70/100	-	5 lb.
Net	20 gp	0 + entangle	1	3/6	-	1 lb.
Shuriken	1 sp	1d4	3	5/10	-	½ lb.
Sling	1 cp	1d4	1	250/360	-	½ lb.
Staff sling	1 gp	1d4+1	1	80/120	-	½ lb.
Bow						
Composite	75 gp	1d6+1	3	150/580	15	1 lb.
Longbow	75 gp	1d8	3	220/400	12	2 lb.
Short bow	30 gp	1d6	3	100/250	8	1 lb.
Crossbow						
Hand	100 gp	1d4	1	30/200	-	3 lb.
Heavy	50 gp	1d10	1/2	180/980	8	15 lb.
Light	35 gp	1d6	1	200/400	-	7 lb.
Repeating	250 gp	1d4+1	2	90/140	-	7 lb.
Siege	100 gp	1d12	1/3	90/460	12	18 lb.
Firearm						
Arquebus	50 gp	2d6	1/3	160/250	12	9 lb.
Handgonne	75 gp	2d4+1	1/3	30/600	15	4 lb.
Musket	150 gp	2d4	1/3	50/200	12	17 lb.
Pistol	80 gp	1d10	1/2	10/20	8	3 lb.

Armor

Armor provides a character a base Armor Class (AC). Shields increase AC by 1, 2 or 3 points, depending on their size, and the character's Dexterity modifier is added to the base AC as well.

Leather Armors (AC 11 to 14)

Leather Armor: Soft leather armor is covered under the padded armor category. Leather armor in this game refers to leather that has been boiled in water or oil to make it harder, but also more brittle. It was often turned into leather scales and used to make lamellar or leather scale armor, but might be shaped into leather "plates". The ancient Greeks made a similar armor from layers of stiffened cloth called linothorax.

Padded Armor: Padded armor was the cheapest and lightest form of armor. It might also be called a gambeson, aketon, padded jack or arming doublet. Besides being worn as armor in its own right, it was also worn under chainmail and platemail (thus if a fighter's chainmail or platemail is destroyed by a *rusting grasp* or rust monster, it is reasonable to assume they have padded armor underneath it). Padded armor can be made of either cloth or leather. Buff coats from the 17th century might also be counted as padded armor.

Studded Leather: Studded leather armor consists of a soft leather backing in which are embedded with metal studs. It is also called bezainted armor. A jack of plates or coat of plates was quilted armor with metal plates sewn into the quilts. In India, it was known by the poetic name "coat of ten thousand nails."

Mail Armors (AC 13 to 16)

Banded Mail: Also known as laminar armor, *lorica segmentata* or "samurai armor", banded mail is composed of horizontal, overlapping rows of solid armor plates worn over padded armor. Banded mail is common in Asian cultures and settings.

Chainmail: More properly called mail, chainmail consists of metal rings linked together in a mesh. It is called a hauberk if it hangs down to the knees, a haubergeon if it hangs down to mid-thigh and a byrnie if it hangs down to the waist. Chainmail might also be turned into a form-fitting suit that covers the body from head to toe. Chainmail that is concealed between layers of fabric or leather is called jazzeraint.

Ring Mail: Ring mail is composed of rings sewn onto a backing of leather or cloth.

Scale Mail: Scale armor comes in several varieties, all of which consist of metal scales laced onto a leather backing. Lamellar is armor of scales that are lashed more thoroughly together so that they become rigid and requires no leather backing. Scale mail is common in Asian settings.

Splint Mail: Splint mail, also known as splinted mail or plated mail, is a chainmail hauberk with small metal plates embedded in it.

Plate Armors (AC 15 to 18)

Breastplate: While breastplates are part of a suit of platemail and plate armor, they were also worn separately in the 16th century and 17th century. If the armor covers both front and back, it is called a cuirass; otherwise the breastplate's AC does not count against attacks from the rear. The breastplate has guards that hang over the abdomen and thighs.

Platemail: Platemail consists of a suit of mail covered by metal plates positioned to guard vulnerable areas. The only parts of the body that are not covered by plates are the joints, which are protected by the mail. Another type of platemail from Asia is called mirror armor or disc armor. It consists of a suit of chainmail with oblong plates or discs protecting the lower torso.

Plate Armor: Plate Armor, also called jousting armor, Gothic plate or full plate, consists entirely of metal plates that are so perfectly fitted together that no joints are exposed. Padded armor is worn beneath it.

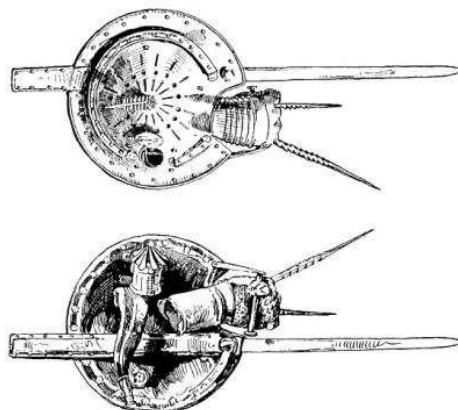

Armor

Armor	Cost	Base AC	Weight
Padded armor	5 gp	11	10 lb.
Leather armor	10 gp	12	15 lb.
Studded leather	25 gp	13	20 lb.
Ring mail	20 gp	13	25 lb.
Scale mail	50 gp	14	30 lb.
Chainmail	150 gp	15	40 lb.
Breastplate	200 gp	15	30 lb.
Splint mail	200 gp	16	45 lb.
Banded mail	250 gp	16	35 lb.
Platemail	600 gp	17	50 lb.
Plate Armor	1,500 gp	18	50 lb.

Shield	Cost	AC Bonus	Weight
Buckler	7 gp	+1	5 lb.
Shield	15 gp	+2	10 lb.
Shield, lantern	150 gp	+1	40 lb.
Shield, tower	30 gp	+3	45 lb.

Additions	Cost	AC Bonus	Weight
Armor spikes	+50 gp	—	+10 lb.
Gauntlet, locked	8 gp	—	+5 lb.
Shield spikes	+10 gp	—	+5 lb.

Shields (+1 to +3 AC)

Buckler: Bucklers, or roundels or targes, are small shields about 1 to 2 feet in diameter that are gripped with the fist. They are usually circular.

Shield: A shield is larger than a buckler, ranging from 3 to 4 feet in diameter for round shields, or of similar size for rectangular shields, kite shields, and the triangular heater shields often associated with knights.

Lantern Shield: These odd creations are composed of a metal buckler with a hook attached that can hold a lantern. A spiked gauntlet is also attached to the shield, so it cannot be disarmed, and finally a longsword is attached to the device, allowing it to be used as both a buckler and a weapon that deals 1d8 points of damage.

Tower Shield: Also called pavises, these large shields are used to protect the entire body, and were primarily used by crossbowmen and archers. They have spiked bottoms, allowing them to be affixed to the ground. The mantlet was a larger design used to protect several

men-at-arms. A tower shield cannot be wielded in melee combat except by large creatures like ogres.

Armor Spikes: You can add spikes to your armor to deal +1 point of damage on a successful grapple attack. You can also make a regular melee attack (or off-hand attack as though using two weapons) with the spikes. A magic bonus to a suit of armor (e.g. +1 *platemail*) does not make the spikes a magic weapon.

Locked Gauntlet: This armored gauntlet has small chains and braces that allow the wearer to attach a weapon to it so that it cannot be dropped easily. It provides a -5 penalty on any disarm attack made against that weapon. Removing or attaching a weapon takes an entire round.

Shield Spikes: When added to your shield, spikes turn it into a weapon that deals 1d4 damage. A spiked magic shield does not count as a magic weapon.

Other Equipment

Item	Cost	Weight
Backpack	2 gp	2 lb.
Barrel	2 gp	30 lb.
Basket	4 sp	1 lb.
Bedroll	1 sp	5 lb.
Bell	1 gp	—
Blanket, winter	5 sp	3 lb.
Block and tackle	5 gp	5 lb.
Bottle, wine, glass	2 gp	—
Bucket (empty)	5 sp	2 lb.
Caltrops	1 gp	2 lb.
Candle	1 cp	—
Canvas (sq. yd.)	1 sp	1 lb.
Case, map or scroll	1 gp	1/2 lb.
Chain (10 ft.)	30 gp	2 lb.
Chalk, 1 piece	1 cp	—
Chest (empty)	2 gp	25 lb.
Crowbar	2 gp	5 lb.
Fishhook	1 sp	—
Fishing net, 25 sq. ft.	4 gp	5 lb.
Flask (empty)	3 cp	1.5 lb.
Flint and steel	1 gp	—
Grappling hook	1 gp	4 lb.
Hammer	5 sp	2 lb.
Ink, black (1 oz. vial)	8 gp	—
Ink, colored (1 oz. vial)	16 gp	—
Ink pen	1 sp	—
Iron spike	1 sp	0.5 lb.
Jug (1 gallon)	3 cp	9 lb.
Ladder, 10-foot	5 cp	20 lb.
Lamp, common	1 sp	1 lb.
Lantern, bullseye	12 gp	3 lb.
Lantern, hooded	7 gp	2 lb.
Lock	40 gp	1 lb.
Manacles	15 gp	2 lb.
Mirror, small steel	10 gp	0.5 lb.
Mug/Tankard	2 cp	1 lb.
Oil (1-pint flask)	1 sp	1 lb.
Paper (sheet)	4 sp	—
Parchment (sheet)	2 sp	—
Pick, miner's	3 gp	10 lb.
Pitcher	2 cp	5 lb.
Pole, 10-foot	2 sp	8 lb.

Pot, iron	5 sp	10 lb.
Pouch, belt (empty)	1 gp	0.5 lb.
Rations, iron (per day)	5 sp	1 lb.
Rope, hempen (50 ft.)	1 gp	10 lb.
Rope, silk (50 ft.)	10 gp	5 lb.
Sack (empty)	1 sp	0.5 lb.
Sealing wax	1 gp	1 lb.
Sewing needle	5 sp	—
Signal whistle	8 sp	—
Signet ring	5 gp	—
Sledge	1 gp	10 lb.
Soap (per lb.)	5 sp	1 lb.
Spade or shovel	2 gp	8 lb.
Spyglass	1,000 gp	1 lb.
Tent	10 gp	20 lb.
Torch	1 cp	1 lb.
Vial, glass	1 gp	—
Waterskin (2 quart)	1 gp	4 lb.
Whetstone	2 cp	1 lb.

Alchemy	Cost	Weight
Acid (flask)	10 gp	1 lb.
Alchemist's fire (flask)	20 gp	1 lb.
Antitoxin (vial)	50 gp	—
Holy water (flask)	25 gp	1 lb.

Tools	Cost	Weight
Alchemist's lab	500 gp	40 lb.
Artisan's tools	5 gp	5 lb.
Disguise kit	50 gp	8 lb.
Healer's kit	50 gp	1 lb.
Holy symbol, wooden	1 gp	—
Holy symbol, silver	25 gp	1 lb.
Hourglass	25 gp	1 lb.
Magnifying glass	100 gp	—
Musical instrument	5 gp	3 lb.
Scale, merchant's	2 gp	1 lb.
Spellbook (blank)	15 gp	3 lb.
Thieves' tools	30 gp	1 lb.
Water clock	1,000 gp	200 lb.

Clothing	Cost	Weight	Livestock	Cost	Weight
Belt, girdle	5 gp	1 lb.	Barding (horse armor)		
Bliaut	10 gp	2 lb.	Medium creature	x2	x1
Cap, hat	1 gp	0.3 lb.	Large creature	x4	x2
Cape	2 gp	1 lb.	Bit and bridle	2 gp	1 lb.
Cloak	4 gp	1.5 lb.	Camel	15 gp	—
Codpiece	1 gp	0.2 lb.	Dog, guard	25 gp	—
Corset	50 gp	1 lb.	Donkey or mule	8 gp	—
Cote, kirtle	5 gp	1 lb.	Feed (per day)	5 cp	10 lb.
Doublet	20 gp	1 lb.	Horses		
Gloves	8 gp	0.1 lb.	Draught	50 gp	—
Gown	5 gp	2 lb.	Riding	75 gp	—
Hood	1 gp	0.2 lb.	Pony	30 gp	—
Hose	3 gp	1 lb.	Warhorse, heavy	400 gp	—
Jerkin	10 gp	2 lb.	Warhorse, light	150 gp	—
Mantle	2 gp	1 lb.	War pony	100 gp	—
Ruffle	4 gp	0.1 lb.			
Slops	6 gp	1 lb.	Transportation	Cost	Weight
Skirt	3 gp	1 lb.	Caravel	15,000 gp	—
Surcoat, tabard	3 gp	1 lb.	Carrack	30,000 gp	—
Tunic	4 gp	1 lb.	Carriage	100 gp	600 lb.
Veil	1 gp	0.1 lb.	Cart	15 gp	200 lb.
Wimple	1 gp	0.3 lb.	Cog	10,000 gp	—
Cloth			Galleass	35,000 gp	—
Cotton, hemp, jute	x2	-	Galleon	20,000 gp	—
Silk	x3	-	Galley	15,000 gp	—
Damask, velvet	x4	-	Keelboat	3,000 gp	—
Cloth of gold	x5	-	Longship	10,000 gp	—
			Oar	2 gp	10 lb.
Food and Lodging	Cost	Weight	Raft, Rowboat	50 gp	100 lb.
Ale – Gallon	2 sp	8 lb.	Sled	20 gp	300 lb.
Ale – Mug	4 cp	1 lb.	Wagon	35 gp	400 lb.
Banquet (per person)	10 gp	—			
Bread, per loaf	2 cp	0.5 lb.	Services	Cost	
Cheese, hunk of	1 sp	0.5 lb.	Coach cab		3 cp/mile
Inn stay (per day)	5 sp	—	Hireling, trained		3 sp/day
Meals (per day)	3 sp	—	Hireling, untrained		1 sp/day
Meat, chunk of	3 sp	0.5 lb.	Messenger		2 cp/mile
Wine, common, pitcher	2 sp	6 lb.	Road or gate toll		1 cp
Wine, fine, bottle	10 gp	1.5 lb.	Ship's passage		1 sp/mile

Acid: When thrown, deals 1d6 points of acid damage to all within a 5' radius of the point of impact.

Alchemist's Fire: When thrown, deals 1d6 points of fire damage to all within a 5' radius of the point of impact.

Antitoxin: If you drink a vial of antitoxin after being poisoned, you get a second save against the poison.

Caltrops: When thrown on the ground, caltrops cover a 5 square foot area and deal 1d4 damage to creatures that trod on them. Running creatures must stop if they take damage from caltrops. A creature moving at exploration speed can move through caltrops without injury.

Holy Water: When thrown, deals 1d6 points of damage to all undead and Chaotic outsiders within a 5' radius of the point of impact. Unholy water has the same effect on Lawful outsiders.

Oil: A pint of oil burns for 6 hours in a lantern or lamp. You can use a flask of oil as a weapon as well, using the rules for alchemist's fire, except that it takes a full round to prepare a flask with a fuse and there is only a 50% chance of the flask igniting successfully. You can pour a pint of oil on the ground to cover an area of 5 square feet. If lit, the oil burns for 2 rounds and deals 1d6 points of damage to any creature in the area.

Special Materials

The following special materials do not exist in the real world, but might be used in a game of *Blood & Treasure*.

Adamantine: Adamantine is the hardest non-magical metal known to exist. Adamantine weapons can re-roll failed sundering attacks (see Rules of Play: Combat). Adamantine armor (scale, chain, banded, plate) increases the base AC of the armor by +1. Adamantine armor costs an extra 10,000 gp. Adamantine weapons cost an extra 3,000 gp.

Dragon Hide: Master armorers can produce armor and shields of extraordinary quality from dragon hide. One large dragon produces enough hide for a single suit of leather type armor (see above). Dragon hide armor costs double what normal armor of that type ordinarily costs, but it takes no longer to make than ordinary armor of that type. Dragon hide increases armor's bonus by +1.

Mithral: Mithral is a rare, silvery metal that is lighter than iron but just as hard. When worked like steel, it becomes a wonderful material from which to create armor and is occasionally used for other items as well. An item made from mithral weighs half as much as the same item made from other metals. Items not primarily

made of metal are not meaningfully affected by being partially made of mithral. Armor made of mithral costs an extra 4,000 gp. Shields made from mithral cost an extra 1,000 gp. Other items cost an extra 500 gp/lb.

Silver: A complex process can bond silver to a steel weapon so that it can damage ethereal creatures and lycanthropes. The silvering process cannot be applied to non-metal items, nor on rare metals such as adamantite and mithral. Silver ammunition costs an extra 2 gp and silver weapons cost an extra 30 gp.

Henchmen and Hirelings

Henchmen and hirelings are men and women that can be hired by player characters to join their retinue or they can be hired to do a single job.

Non-player characters that enter a PC's retinue are called henchmen. Henchmen demand a wage and the PC might also be required to furnish them with the tools they require. Pay for a henchman is roughly as follows:

Daily Pay	Job Description
1 cp	Will carry torches and bags, but will not fight
1 sp	As above, plus will fight in the second rank
1 gp	As above, plus will fight in the first rank
1 pp	As above, plus check for traps and enter rooms first

Hirelings are paid to do a specific job. This job might take a few minutes or a few weeks, but the hireling does not join the PC's retinue or accompany them into the wilderness. A PC who wants a new suit of armor, for example, would hire an armorer to make the armor for him. A PC who wanted to hire an armorer to follow him around and maintain his armor and weapons would have to add that armorer to his retinue as a henchman.

PC's that have constructed a stronghold are permitted to have more followers in their retinue than their Charisma score would normally allow.

Finding Henchmen

Some TKs might find it sufficient to allow players to find any kind of henchman they desire, in essence "buying" them as easily as they would buy a piece of equipment. Others might wish to make a game of it. For those TKs, we provide the following system.

Each PC can spend a day seeking out henchmen through advertisements such as hiring a town crier or posting handbills, and buying drinks at a local tavern). For each 10 gp they devote to this activity they get a "search

point". The player then rolls 1d20 and attempt to roll beneath his number of search points + his charisma modifier. For every point below his search point total that he rolls, he gets one applicant to join his retinue. If adventurers are looking for a specific kind of henchman, the cost per search point is increased to 100 gp and the henchman found is exactly what they are looking for. Otherwise, roll on the following tables.

d20	Henchman Quality
1-4	0 HD commoner
5-6	0 HD rogue (see below)
7-12	Man-at-arms
13-15	1st level of a basic class
16-17	1st level of an advanced class
19	1d3+1 level of a basic class
20	1d3+1 level of an advanced class

d10	Basic Class	Advanced Class
1	Fighter	Assassin
2	Fighter	Barbarian
3	Fighter	Bard
4	Thief	Druid
5	Thief	Duelist
6	Thief	Monk
7	Cleric	Paladin
8	Cleric	Ranger
9	Magic-User	Sorcerer
10	Magic-User	Multi-class (Roll twice on basic column)

d4	Henchman Personality
1	Choleric (ambitious, aggressive, passionate)
2	Melancholic (introverted, thoughtful, considerate)
3	Sanguine (impulsive, sociable, boisterous)
4	Phlegmatic (relaxed, quiet, sometimes lazy)

d6	Alignment	1-2	3-4	5-6
1	Chaotic	LE	NE	CE
2-5	Neutral	LN	N	CN
6	Lawful	LG	NG	CG

The percentage of applicants who are human versus another race is up to the TK, although all multi-class henchmen are non-human.

Henchmen with class levels demand a half share of treasure and 10 gp per day per level, and they receive a half-share of earned experience points.

Zero HD henchmen have a 1 in 6 chance of being extraordinary individuals who are capable of becoming 1st level NPCs after they survive their first adventure.

The following hirelings are common to most fantasy-style game worlds.

Alchemist: Alchemists are pseudo-scientists and minor workers of wonder. They are capable of manufacturing acid, alchemist's fire and oil. Magic-users, sorcerers and bards attempting to craft magic items require the aid of alchemist. It takes an alchemist one day per 10 gp of the sales price of an alchemical item to craft that item. Alchemists demand a salary of 10 gp per week plus room and board. They can cast spells as an adept (see below).

Animal Trainer: Animal trainers are capable of taming animals and teaching them tricks. Most animal trainers can train animals for heavy labor, fighting, riding, guard duty or hunting in one month or teach them a trick in a week. Most animal trainers are only capable of training domesticated animals. One in six animal trainers is capable of training wild animals and 1 in 20 is capable of training magical beasts and dragons. Animal trainers are paid 5 gp per week plus room and board, 25 gp for wild animal trainers and 50 gp for monster trainers.

Armorer: Armorers are smiths who manufacture and repair armor and melee weapons. One armorer can maintain the armor and weapons of one hundred men-at-arms. It takes an armorer one week per 25 gp of the sales price of an item to craft that item. A magic-user manufacturing magical armor or weapons requires the services of an armorer. An armorer is paid 5 gp per week plus room and board, and the forge must be provided.

Artisan: Artisan is a term that applies to blacksmiths, carpenters, coopers (barrel-makers), chandlers (candle-makers) and other basic craftsmen. It takes an artisan one week per 5 gp of an item to finish it. An artisan is paid 2 gp per week plus room and board. A forge must be provided for a blacksmith.

Bearer: A bearer is a simple laborer hired to carry a torch or lantern, haul treasure, lead mules, etc. A bearer is paid 1 cp per day.

Bowyer: A bowyer is an expert craftsman who makes and repairs bows, crossbows, slings and other ranged weapons and their ammunition. One bowyer is required to maintain the ranged weapons of 50 men-at-arms. It takes a bowyer one week per 25 gp of the sales price of an item to craft it. Spellcasters attempting to make magic

ranged weapons or ammunition require the services of a bowyer. A bowyer is paid a wage of 5 gp per week.

Engineer: Engineers can operate and construct siege engines and gunpowder weapons and undermine walls and other defenses. Spellcasters attempting to build constructs require the services of an engineer, who must be provided with tools. It takes one engineer and two or more men-at-arms to operate siege engines like catapults and ballistae. It takes an engineer one week per 40 gp of the sales price of an item to craft that item. They are paid 10 gp per week.

Jeweler: A jeweler combines the skills of a gem cutter, silversmith and goldsmith. They are the most skilled of the smiths and the wealthiest, and most jewelers have 1d6 x 1,000 gp on hand to purchase gems and jewelry looted from dungeons. Magic-users require a jeweler to manufacture magical pieces of jewelry (amulets, rings, etc.) and other intricate little items. It takes a jeweler one week per 30 gp of the sales price of an item to craft that item. Jewelers are paid a wage of 10 gp per week.

Man-at-Arms: Men-at-arms are mercenary soldiers that can be employed to aid adventurers in their assaults on dungeons or to protect expeditions into the wilderness. Men-at-arms come in the following varieties:

d10	Man-At-Arms
1-3	Archer
4	Horse Archer
5-8	Infantry
9-10	Cavalry

Archers are armed with bows, crossbows or slings. They are paid a wage equal to 10% of the cost of their armor and primary weapon per week. Use the following table to determine their gear, rolling separately for armor and missile weapon. Archers also carry a short sword or hand axe. Halfling slingers are +1 to attack with slings, and charge double. Elven archers are +1 to attack with bows, and charge double.

d6	Armor	Missile Weapon
1	None	Javelins (5)
2	Padded	Sling, 40 bullets
3	Leather	Short bow, 40 arrows
4	Ring armor	Longbow, 40 arrows
5	Studded leather	Light crossbow, 20 bolts
6	Scale armor	Heavy crossbow, 20 bolts

Cavalry are paid a weekly wage equal to 10% of the value of their armor and horse. Cavaliers are always armed with a lance and longsword. Roll first for the

warhorse. Cavaliers on light warhorses roll 1d4 to determine armor, while cavaliers mounted on heavy warhorses roll 1d4+2 for armor.

d6	Horse	Armor
1	Light warhorse	Ring armor + shield
2	Light warhorse	Scale armor + shield
3	Light warhorse	Chainmail + shield
4	Heavy warhorse	Splint armor + shield
5	Heavy warhorse	Banded armor + shield
6	Heavy warhorse	Platemail + shield

Horse archers are usually steppe or desert nomads who can fire their short bows from horseback without any penalty. Horse archers have leather armor, short bows and short swords and ride light warhorses. They are paid 12 gp per week.

Infantry are usually armed with spears or polearms, but also carry short swords or hand axes. Infantry with spears also carry shields, while those with two-handed weapons do not. They demand a weekly wage equal to 10% of the cost of their armor and main weapon.

d8	Armor	Weapon/Shield
1	Leather	Longsword, shield
2	Studded leather	Spear, shield
3	Ring armor	Billhook
4	Scale armor	Poleaxe
5	Chainmail	Glaive
6	Breastplate	Guisarme
7	Banded or splint armor	Halberd
8	Platemail	Pike

A **sergeant** can command nine men-at-arms on his own, or assist a character in commanding 48 men-at-arms. They are equipped as their troops. Sergeants are paid three times as much as the men they command.

Priest: A priest is a non-adventuring clergyman who oversees parish churches and temples. Lesser priests are called acolytes and might be found in villages and in the fortresses of minor nobles (where they are called chaplains). Vicars oversee the temples of towns and are usually in charge of all the acolytes in their area. Prelates oversee temples in great cities and are usually in charge of all the vicars in their region.

Priests cannot be hired by the week, but they can be hired to cast spells. They do not know how to fight in armor. Lawful and Chaotic priests are barred from using edged and piercing weapons, but Neutral priests are not. They rarely carry more than a club, mace or dagger.



Priests can cast spells as an adept (see below).

Rogue: A rogue is a commoner with a 3 in 6 chance of performing any of the following tasks successfully: Climb walls, find/remove traps, hear noise, hide in shadows, listen at doors, move silently, open locks and pick pockets. They are not warriors, and typically run away from combat. A rogue demands a minimum of 40 gp for each “job” they undertake, and 10% of the take.

Sage: A sage is a scholar hired to answer questions. A guild of sages is called a “university”, and the wealthiest city-states endow universities to train their nobles and clergy. Sages specialize in a single subject, chosen by the TK. Specialties include cosmology, geography, history, magic, monsters, nature, philosophy and religion.

If a question is in a sage’s specialty, she has a 5 in 6 chance per week of answering it. If it is in any other subject, she has a 3 in 6 chance per week of answering the question. Sages are paid 50 gp per week to research the answers to questions in their specialty and 30 gp per week to answer other questions. Sages have a 15% chance of casting spells as an adept.

Adepts

Adepts are spell casters that are much less powerful than the adventuring spellcasting classes. Alchemists, sages, shamans, priests and witch doctors might all count as adepts. Adepts have the normal stats for their monster type, regardless of their adept level.

Adept Spells per Day

Level	1st	2nd	3rd	4th
1	1	—	—	—
2	2	1	—	—
3	3	2	1	—
4	3	3	2	1
5	3	3	3	2

Adepts do not prepare their spells ahead of time (since that would make extra work for the TK), but rather pluck them from the list as they go along.

Adepts choose their spells from the following list:

1st Level Spells

Cure light wounds	Dancing lights
Detect evil/good	Detect magic
Identify	Light
Protection from evil/good	Pyrotechnics
Shield	Ventriloquism

2nd Level Spells

Audible glamer	Augury
Cause fear	Chant
Detect invisibility	Energy resistance
Invisibility	Levitate
Magic Mouth	Speak with animals

3rd Level Spells

Cure blindness/deafness	Cure disease
Dispel magic	Locate object
Prayer	Remove curse

4th Level Spells

Divination	Neutralize poison
Tongues	

Rules of Play

4

In *Blood & Treasure*, play is between the players and the Treasure Keeper. The TK describes what is happening, the players act and react, and the TK then adjudicates the chances of success or failure.

The following sections present guidelines for handling many of the situations that will arise in a typical game. They do not cover

every possibly contingency, but that is why the game has a referee, the TK.

Exploration

Exploring the underworld and trekking out into wild places is an activity fraught with danger, but that's where the treasure is hidden!

The following notes will help you adjudicate a dungeon exploration:

Time

Time is divided into rounds (which equal 6 seconds), minutes, turns (which equal 10 minutes), hours, days, etc.

Some of the uses for these time period are as follows:

Rounds	Combat, spell durations and running
Minutes	Spell durations and running
Turns	Spell durations
Hours	Spell durations, wandering monster checks
Days	Spell durations, random challenge checks

Dungeon Movement

The average medium-sized humanoid walks at a speed of 3 miles per hour. In terms of distance per time period, that movement rate comes out as follows:

Per Round	Per Minute	Per Hour
30'	90 yards	3 miles

Some medium-sized creatures are slower or faster, and smaller and larger creatures also walk at other speeds:

For faster and slower speeds, use the following guide:

Per Round	Per Minute	Per Hour
10'	30 yards	1 mile
20'	60 yards	2 miles
40'	120 yards	4 ½ miles
50'	160 yards	5 ½ miles
60'	200 yards	7 miles

These figures are not precisely correct, but they are close enough for our purposes. The "feet per round" figure is termed in these rules a creature's "movement rate".

Characters can hustle at double their walking speed for 10 minutes before they are fatigued and must stop.

Characters can run at four times their walking speed for 1 minute before they are fatigued and must stop.

Most characters swim at a speed of 10' per round.

Most characters climb at a rate of 5' per round.

Encumbrance

The strength table in Chapter 2 shows a character's carrying capacity based on their strength score. If a character carries more than their carrying capacity, their movement rate is reduced by 10' and they cannot run.

If they carry double their carrying capacity, their movement rate is reduced by 15' and they cannot jog. They cannot carry more than double their carrying capacity and still move.

Carrying capacity is multiplied by 5 when dragging, and by 10 when pulling something on wheels.

Exploration Speed

Exploration speed is at 10' per round. At this speed, a character has the normal chances of surprise and they may attempt saving throws to avoid traps. Moving faster than 10' per round in a dungeon increases the chances of surprise by +1 in 6 (see Combat below) and permits no saving throws against traps.

Wilderness Movement

Movement in the wilderness assumes 6 hours of travel per day. This can be doubled by passing a saving throw.

Typical wilderness movement rates are as follows:

Elf
(40')



15 miles per day
1 lb. food/day
½ gal. water/day

Dwarf
Half-Elf, Orc
Human
(30')



12 miles per day
1 lb. food/day
½ gal. water/day

Gnome
Halfling
(20')



9 miles per day
1 lb. food/day
½ gal. water/day

Horse

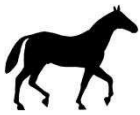

16 miles per day
15 lb. food/day
5 gal. water/day
Carry 500 lb.

Camel

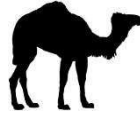

20 miles per day
10 lb. food/day
¼ gal. water/day
Carry 600 lb.

Pegasus



36 miles per day
15 lb. food/day
5 gal. water/day
Carry 400 lb.

Donkey/Mule



16 miles per day
6 lb. food/day
5 gal. water/day
Carry 90 lb.

Elephant

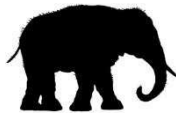

18 miles per day
200 lb. food/day
40 gal. water/day
Carry 1,200 lb.

Griffon



18 miles per day
20 lb. food/day
7 gal. water/day
Carry 600 lb.

Llama



15 miles per day
5 lb. food/day
1 gal. water/day
Carry 130 lb.

Ox



5 miles per day
30 lb. food/day
10 gal. water/day
Carry 200 lb.

Reindeer



75 miles per day
2 lb. food/day
5 gal. water/day
Carry 120 lb.

These movement rates (most of them) are derived from Col. Sir Garnet J. Wolseley's excellent *The Soldier's Pocket-Book for Field Service*, and are based upon his military service during the 19th century.

Water Movement

While movement on the water really depends on wind and current speed, the following figures should suffice for most campaign play.

Vessel	Miles per Day
Barge, Raft	6
Keelboat	12
Cog	48
Galley	36
Galleass	42
Knarr	72
Longship	60
Caravel	72
Carrack	78
Galleon	120

Light

The table below shows the radius of illumination from various sources of light, as well as their duration.

When a candle or torch runs out, it must be discarded.

When a lamp or lantern reaches its duration, it must be refilled with a pint of oil.

Candle



5' radius
1 hour

Lamp



25' radius
6 hours/pint of oil

Torch



30' radius
1 hour

Lantern, Hooded



45' radius
6 hours/pint of oil

Lantern, Bullseye



90' cone
6 hours/pint of oil

Wilderness movement is halved over rough terrain, such as wetlands and highlands, and at night.

Survival

Use the following guidelines for dangers in your game.

Conditions

Conditions are a useful short hand for dealing with ill effects. The following conditions are used in the game:

Blinded creatures treat all foes as though they were invisible. They are surprised on a roll of 1-3 on 1d6.

Comatose creatures cannot be awakened by any means.

Crippled creature's movement is reduced by half and they suffer a -2 penalty on saving throws.

Dazed creatures lose one turn, but can defend themselves.

Deafened creatures are surprised on a roll of 1-3 on 1d6.

Entangled creatures cannot move except by wriggling at 1' per round. Entangled spellcasters cannot cast spells.

Fatigued creatures move at half their movement rate and suffer a -2 penalty to hit, save, and to Armor Class.

Frightened creatures run from the source of their fright. If a frightened creature is unable to flee and must fight, their opponent has a tactical advantage (see Combat).

Mad or insane creatures are affected by the *confusion* spell, checking once per round during combat or other tense situations, or once per hour otherwise.

Paralyzed creatures cannot move or take actions, but can perform purely mental functions.

Petrified creatures are turned to stone and are considered unconscious. Damage sustained by a petrified creature (e.g. the loss of a limb or head) is carried over to the creature when it is un-petrified.

Prone creatures have been knocked to the ground. Opponents with melee weapons get a tactical advantage, while prone creatures have a tactical advantage against foes with ranged weapons.

Sickened creatures are dizzy and nauseated. They suffer a -2 penalty to attack rolls and saves.

Stunned creatures cannot move or attack and they drop any item they hold. Opponents gain a tactical advantage.

Saving Throws

A saving throw is a roll of the dice intended to save your character from a terrible fate. A saving throw (or "save") is made by rolling 1d20, adding any relevant modifiers for a character's ability scores, race or class, and trying to equal or exceed a set saving throw value determined by a character's class and level (found on the class advancement charts in Chapter 2).



A successful save against an effect negates that effect. A successful save against damage cuts that damage in half.

Saving throws against death, paralysis, disintegration, petrification and being *polymorphed* against one's will are made at a **+3 bonus** to the saving throw.

Saving throws against spells cast from magic items, such as wands, staves and wands, are made at a **+1 bonus**.

Spellcasters and magic-using monsters enjoy an extra **+1 bonus** to save against magic spells in addition to their bonus against spells from magic items.

Item Saving Throws

When an object is required to pass a saving throw, use the values below based on the weakest material in the object's construction. Magic items, no matter what they are made of, save as adamantine and magic armor and weapons add their magical bonus to their roll.

Material	Target
Paper	20
Glass	18
Cloth	17
Leather	16
Clay	15
Wood	14
Stone	10
Precious stone	12
Gold and silver	8
Copper, platinum and alchemical silver	7
Bronze	6
Iron	5
Steel and mithral	4
Adamantine	3

Evading Monsters

When evading monsters, chance of success is found by subtracting the monster's movement rate from that of the characters (or vice versa if it is the monsters that are attempting to run away from the adventurers). If the adventurers are sticking together, use the slowest member's movement rate for the entire party. If they are splitting up, roll separately for each adventurer.



Difference	Chance of Evasion
20+	1 on 1d6
10	1-2 on 1d6
0	1-3 on 1d6
10	1-4 on 1d6
20+	1-5 on 1d6

Starvation and Thirst

Characters must eat one day's rations (or at least two meals) each day or become fatigued. A character that eats nothing at all suffers one point of strength, dexterity and constitution damage each day.

Characters must drink ½ gallon each day or become fatigued. A character that drinks nothing suffers 2 points of strength, dexterity and constitution damage each day.

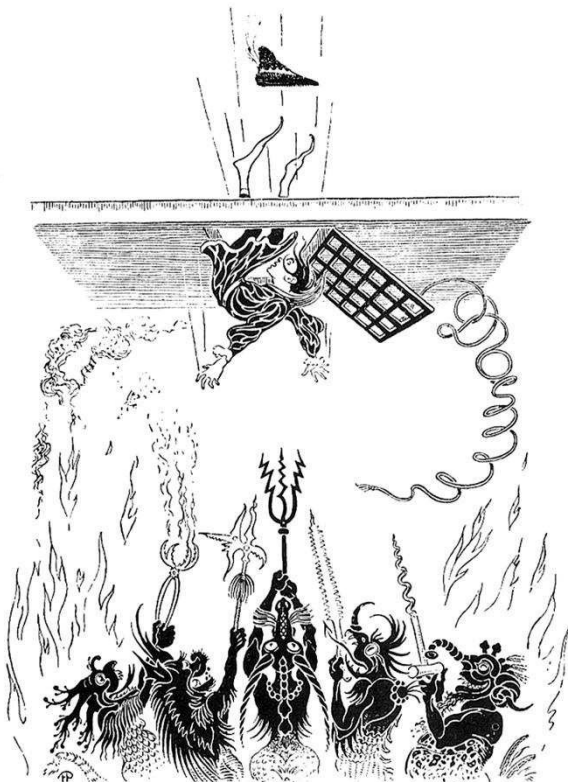

Falling

Falling damage is 1d6 per 10' of a fall. A saving throw cuts this damage in half. The maximum damage a person can suffer from a fall is 10d6.

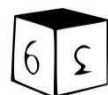

If the person falling fails their saving throw, they have a chance of being crippled. This percent chance is equal to the distance of the fall in feet and the condition lasts for 1 day per 10' of the fall.

Example: A dwarf falls 90'. This inflicts 9d6 points of damage and has a 90% chance of crippling her if she fails a saving throw.

Damage can be modified by the TK. Falling into a pile of hay could decrease the damage dice to d4 instead of d6. Falling onto spikes or jagged rocks could increase the damage dice to d8 or d10 instead of d6.

Disease

When a character is struck with disease, either by a monster attack, an infected blade or needle, or by being in an unhealthy environment, such as a sewer, use the following procedure.

First, the character should attempt to save vs. disease. If successful, they are not infected.

If the saving throw is failed, roll 1d6 plus the monster's Hit Dice, or for traps the dungeon level (use a level of 1 if in the wilderness) on the table below.

d12	Effect	Onset Time
1-4	Fatigue	1 round
5-7	Sickened (every 1d6 hours, for 1 turn)	1 turn
8-9	Ability damage (1 point/day)	2 days
10+	Constitution damage (1 point/day)	2 days

If an ability score is indicated, roll 1d10 to determine which score is affected:

d10	Ability	Explanation
1-2	Strength	Muscle degeneration
3-4	Dexterity	Loss of balance, numbness in extremities
5-6	Intelligence	Brain fever, amnesia
7-8	Wisdom	Hallucinations
9-0	Charisma	Skin rash, foul odors, pox marks

The character suffers all of the symptoms on the table up to the number rolled. Each day, the character may

attempt another saving throw vs. disease. Each success removes the worst symptom from the disease. A three symptom disease, therefore, will take at least three days to overcome. Of course, an application of *cure disease* removes all symptoms automatically.

Poison

Poison comes in four varieties. A character that consumes or is injected with poison must succeed at a saving throw or succumb to its effects. The effects of poison are suffered immediately.

Type	Effect
I	Sleep for 1d6 turns
II	Paralyzed for 1d6 turns
III	1d6 points of hit point damage
IV	1d6 points of Con damage per minute until dead

Swimming

Characters can swim at a speed of 10' for 1 turn before they become fatigued. They can swim at double this speed for 1 minute before they fatigued.

A fatigued character in the water must roll 1d20 under their constitution score each round or begin drowning. The character must hold their breath. When they can hold it no longer, they die 1 minute later if not rescued. Even if they are rescued, they suffer 1d6 points of damage to their constitution and intelligence scores.

Characters can hold their breath for 1 minute if they have an average constitution (score of 9 to 12). If their constitution is lower, they can hold their breath for 30 seconds. If higher, they add 1 minute to the time they can hold their breath per point of constitution bonus.

Rangers and barbarians can hold their breath for an additional minute, and swim at a rate of 15' for 1 turn before they become fatigued.

Non-Combat Tasks

To perform tasks outside of combat, one need only tell the TK what they wish to accomplish. If the TK thinks the task can be accomplished without much difficulty, she tells the player they are successful.



If success is in doubt, either because of the degree of difficulty of the task, or special conditions that would make success unlikely, the TK can require a task check.

To make a task check, the player rolls 1d20 and adds the character's relevant ability score modifier (see table below) and any bonuses for their race, class or other circumstances (determined by the TK).

If the roll is 18 or higher, the task check is a success. If the roll is lower than 18, it fails, with the consequences determined by the Treasure Keeper.

If the TK thinks the character is trained at the task due to their class or some other background factors, they **add their level** to the task check.

The ability scores associated with tasks are as follows, although the TK may rule that under some conditions a task is modified by a different ability score.

Ability	Associated Tasks
Int	Alchemy, Appraise, Find Secret Doors, Healing, Lore, Navigate, Read Languages, Set Snares
Wis	Hear Noise, Survival, Tracking
Dex	Acrobatics, Climbing Walls, Find/Remove Traps, Forgery, Hide in Shadows, Move Silently, Open Locks, Pick Pockets, Riding
Cha	Carouse, Conversion, Disguise, Handle Animal, Taunt

Several tasks rely on using tools. Performing these tasks without the proper equipment is done at a -4 penalty.

The key thing to remember about tasks checks is that if it seems reasonable that a character can do it, there is no need to roll the dice!

Skill Points (Optional)

If your players would like more control over their character's skills – and you want them to have that control – you can allow them to spend "skill points" on the various tasks in this chapter, each point spent giving them a +1 bonus to use those skills in play. This replaces the normal skills attached to the character classes.

When attempting a task, the player rolls 1d20, adds their skill bonus and relevant ability score modifier, and attempts to roll an '18' or higher to succeed.

The number of skill points available to a character to spend at each level depends on the class. Multi-class characters add their class' skill point totals together.

Class Skill Points

Skill Points	Classes
8	Assassin, thief
7	Monk
6	Barbarian, bard, ranger
2	Cleric, druid, duelist, magic-user
1	Fighter, paladin, sorcerer

Simple Task Checks (Optional)

If you would like task checks to be even simpler, you may use the following system:



If characters attempt something at which they are untrained, roll 1d6. On a roll of 1, they succeed.

If they are attempting something at which they excel due to their race, such as elves finding secret doors, roll 1d6. On a roll of 1 to 2, they succeed.

If they are attempting something at which they are skilled due to their character class, such as thieves climbing walls, consult the following table:

Level	Chance of Success
1-2	Roll 1-2 on 1d6
3-6	Roll 1-3 on 1d6
7-10	Roll 1-4 on 1d6
11-14	Roll 1-5 on 1d6
15-20	Roll 1-7 on 1d8

If the task is more difficult than usual, the TK can rule that it must be rolled on a larger dice.

Note that this system does not take into account ability scores, which may disappoint some players.

Encounters

When strangers meet in a dungeon or in the wilderness, roll a reaction check on 1d10.



Chaotic creatures are hostile on a roll of 1-5. They are never friendly.

Neutral creatures are hostile on a roll of 1-2 and friendly on a roll of 9-10.

Lawful creatures are friendly on a roll of 6-10.

Hostile creatures either attack or attempt to lure people into a trap. Friendly creatures are willing to render aid.

Otherwise, creatures stay on guard, and are willing to talk and help for a price.

Reaction bonuses increase a Neutral creature's chance of being friendly and reduce their chance to be hostile. They do not influence Chaotic or Lawful creatures.

Encounter Distance

When in dungeons or other close quarters like cities or thick forests, monsters are sighted 1d6 x 20 feet away. In more open spaces, monsters are 1d6 x 60 feet away.

Surprise

When two groups who were unaware of one another meet, there is a chance of surprise. Roll 1d6 for each side. Most creatures are surprised on a roll of 1 or 2.



Some monsters surprise on a roll of 1-3 (or higher) on 1d6. Likewise, characters who are on their own and hiding in shadows surprise on a roll of 1-3 on 1d6.

Some classes (barbarians, duelists, monk and rangers) and monsters are only surprised on a roll of 1. On a higher roll they are not surprised, although other members of their party are surprised.

When a creature that is only surprised on a 1 meets a creature that surprises on a 1-3, they are surprised as though they were a normal character (i.e. on a 1 or 2).

If both sides are surprised, or neither side is surprised, then surprise does not play a role in the encounter.

If one side is surprised, and the other side is not, the latter gets a free round to move and attack or to flee. After this surprise round ends, roll initiative as normal.

Combat

Combat is conducted in 6 second rounds. It begins with an initiative roll by each side, and then the different creatures involved take actions. At the end of the round, monsters and NPCs might have to make a morale check. If anyone is left standing, initiative is rolled again and combat proceeds as normal.

Initiative

Each side rolls 1d6. The side with the highest roll goes first. If the roll is a tie, then all actions happen simultaneously – i.e. no effects are imposed until after both sides have gone.

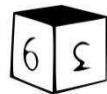

Actions

On their turn, a creature can do one of the following:

- Move their full movement rate as long as they are not within 5' of an enemy combatant
- Move half their movement rate and make an attack
- Move half their movement rate and perform a quick action like drinking a potion or drawing a weapon
- Charge at running speed and attack (see Charge below)
- Cast a spell

Morale Check

At the end of each round, monsters need to check their morale if they have lost more than half their number (for groups), if they have lost more than half their hit points (for a single monster), or if a group of monsters has lost their leader. This is a saving throw. If the morale check is failed, the monsters flee, or, if unable to flee, surrender.

If there are combatants left on both sides at the end of the round, roll initiative again and proceed as above.

Attacks

There are two forms of attack – melee and ranged.

Melee is hand-to-hand combat. Melee occurs when two combatants are within 5' of each other.

To make a melee attack, roll 1d20 and adds attack bonus (Hit Dice for monsters), strength modifier and any modifiers for tactical advantage (see below).



If the result is equal to or higher than the target's AC then they inflict damage (see below).

Ranged attacks are made with crossbows, bows, slings, throwing axes, javelins and firearms.

To make a ranged attack, roll 1d20 and add attack bonus (Hit Dice for monsters), dexterity modifier, any modifiers for tactical advantage (see below) and any range modifiers.

If the result of that roll is equal to or higher than their opponent's AC then they inflict damage.

Ranged weapons are listed in Chapter 3 and are given two ranges, Effective and Maximum. Indoors, these ranges are in feet, and outdoors they are in yards.

Shooting within the weapon's effective range carries with it no penalty to attack.

Shooting at a target beyond the weapon's effective range, and not beyond the weapon's maximum range, is at a -4 penalty to attack.

When a creature shoots into melee, they make an attack roll as normal and then the TK randomly determines which melee combatant is attacked.

In other words, don't shoot into melee.

Inflicting Damage

When an attack is successful, damage is inflicted. The attacker rolls a damage dice determined by the weapon or attack he used. You can find this information on the equipment tables. They add their strength modifier to damage on melee attacks, but not on ranged attacks. Damage from an attack is always at least 1, regardless of modifiers. Damage is deducted from the target's hit point total (see Damage and Death below).

Critical Hits (Optional)

On a natural attack roll of '20', a character may deal an extra 1d6 points of damage.

Critical Fumbles (Optional)

On a natural attack roll of '1, a character loses their next turn (i.e. takes no actions in the next combat round).

Tactical Advantage

Some battlefield conditions give an attacker or defender a tactical advantage. Each tactical advantage an attacker has grants them a +2 bonus to attack. Each tactical advantage a defender has grants them a +2 bonus to Armor Class.

The following conditions may grant a tactical advantage:

- Higher movement rate than opponent
- Higher ground than opponent
- Flyer vs. land-bound opponent
- Aquatic creature attacking a land creature in the water
- Opponent is cowering, frightened, entangled, grappled, prone or stunned
- Opponent is distracted or flanked

Backstabs

Attacking from behind is done at a +4 bonus.

Invisibility

An invisible creature gets a +4 bonus to attack in melee combat and a +4 bonus to AC.

Charging

A character can charge into combat by running at least 30 feet before attacking. The charging combatant adds +2 to any damage he inflicts, but suffers a -2 penalty to his Armor Class until the end of the next round. Some weapons, indicated on the Weapon table in the Equipment section, deal an extra 1d6 points of damage when they are set against a charge attack and hit the charger. Other weapons deal an extra 1d6 points of damage when used on a charge.

Fighting Defensively

A character can choose to fight defensively, sacrificing their attack to concentrate on avoiding damage. This grants a +2 bonus to Armor Class.

Fighting With Two Weapons

Attacks can be made with a light or medium weapon in the primary hand and a light weapon in the secondary hand. The primary weapon suffers a -2 penalty to attack, and the secondary a -4 penalty to attack.

Characters with multiple attacks, such as fighters, can use two-weapon fighting with their first attack of the round, but not the second or subsequent attacks.

Mounted Combat

Mounted combat follows the same basic rules as normal combat, with a few addendums.

- Only mounts trained for combat (e.g. warhorses) can engage in combat, and even then they may only make a single attack. Other mounts are frightened by combat and must pass saving throws or flee the combat.
- Charging on a mount with most weapons is treated like a charge on foot (see Charging above).
- Charging with a lance deals +1d6 points of damage. The horse then attacks either the initial target or, if the initial target is killed, any target behind him. The horse keeps moving to its full move after the attack is made.

- When a mounted combatant suffers damage from a melee attack, they must pass a riding task check or be unseated. A rider that has been stunned in combat must make a saving throw each round or fall from her mount. A rider that is knocked unconscious or paralyzed always falls from the saddle.

- When a mount is reduced to 0 hit points, it falls and inflicts 1d6 points of damage on the rider.

Special Maneuvers

To make a special maneuver, a character makes an attack against an Armor Class of 15. If they are successful, their target may attempt a saving throw to avoid the attack. The modifier to the saving throw depends on the special maneuver that is attempted.

Maneuver	Modifier	Success
Blind	Dex	Opponent blinded for 1 round
Bull Rush	Str*	Opponent knocked back 5'
Daze	Dex	Opponent dazed for 1 round
Disarm	Dex	Weapon knocked 2d6 feet away
Feint	Wis	Opponent loses next attack
Grapple	Str*	Target held and suffers unarmed damage
Overrun	Str*	Move past opponent
Sunder**	Dex	Targeted item must make item saving throw or be ruined for use
Trip	Dex	Opponent falls prone on ground

**For monsters, use the following modifiers based on the creature's size: Tiny -3, Small -1, Large +2, Huge +6*

***Shields can be sundered, but not armor*

Underwater Combat

Combat underwater imposes a couple of difficulties.

- Thrown weapons are ineffective underwater, even when launched from land. Only arrow-like missiles can be used underwater, and their range is reduced by half.
- Non-magical fire does not burn underwater. Fire spells create a bubble of steam but otherwise work as normal.

Turning Undead

Clerics and paladins can make a special attack in place of casting a spell or attacking with a weapon. By presenting their holy symbol, they can cause the undead to recoil in fear, flee or even be destroyed.



When a turning attempt is made, consult the turn undead table below. Find the Hit Dice of the undead to be turned and the level of the cleric doing the turning. Remember that paladins turn as clerics two levels lower. If there are multiple types of undead (for example, a vampire and her zombie minions), take note of the number needed to turn each type of undead.

The player now rolls 1d20. If the roll is equal to or greater than the target number needed to turn the undead, 2d6 Hit Dice worth (starting with the weakest) recoil from the holy symbol, shielding their eyes. Note that it is possible for one type of undead to be turned and a more powerful undead to be unaffected. Any undead that are unaffected are immune to that cleric's turn undead ability for the remainder of the encounter.

If a cleric or paladin makes a second successful turn attempt against the same undead, 2d6 Hit Dice worth (starting with the weakest) must flee from the cleric one minute. If they cannot flee, they cower helplessly.

If a cleric or paladin makes a third successful turn attempt against the same undead, 2d6 Hit Dice worth (starting with the weakest) are destroyed, or, if the cleric is an anti-cleric, placed under the anti-cleric's command for 4 hours. The anti-cleric can only have two Hit Dice of undead under their command per level.

Damage and Death

Hit Point Damage

The most common type of damage is deducted from a creature's hit point pool. Damage from weapons and falling, for example, inflict hit point damage. When a creature's hit points reach 0, they die.

Hit points do not represent anything solid or concrete in and of themselves. Rather, they are part of a complex calculation that boils down to this: "What are the chances that the next moment of mortal peril a creature has is their last!" That mortal peril might be the thrust of a sword, a jab from a poison needle, falling through a trap door, or anything that can lead to death. Most often, hit point damage is from combat.

It is important to remember that hit points are only part of the combat calculation for how likely you are to die. The complete calculation is in two parts. The first part pits your opponent's fighting skill against your armor and quickness (i.e. his or her attack roll vs. your Armor Class). The second part pits your opponent's strength and weapon type against your own fighting skill (i.e. his or her damage roll vs. your hit points). While most of the numbers in these calculations are fairly static, hit points move around quite a bit, decreasing due to peril and sometimes increasing due to healing or rest. The more danger you experience, the more likely your next dangerous act is your last.

Turn Undead Table

Undead HD	Cleric Level										
	1	2	3	4	5	6	7	8	9-13	14-18	19+
1	10	7	4	3	2	1	1	1	1	1	1
2	13	10	7	4	3	2	1	1	1	1	1
3	16	13	10	7	4	3	2	1	1	1	1
4	19	16	13	10	7	4	3	2	1	1	1
5	20	19	16	13	10	7	4	3	2	1	1
6	-	20	19	16	13	10	7	4	3	1	1
7	-	-	20	19	16	13	10	7	4	1	T
8	-	-	-	20	19	16	13	10	7	2	1
9	-	-	-	-	20	19	16	13	10	3	2
10	-	-	-	-	-	20	19	16	13	10	3
11	-	-	-	-	-	-	20	19	16	13	10
12	-	-	-	-	-	-	-	20	19	16	13
13 +	-	-	-	-	-	-	-	-	20	19	16

This is why a character can go from 100 hit points down to 1 hit point without suffering any particular physical hardship. All of those lost hit points represent narrow misses, lucky breaks and scrapes and scratches. The last hit point lost, however, represents a sword in the heart, a knife in the back, a quaff of poisoned wine or a plunge off a cliff onto the rocks below.

The alternate dying system (see below) provides an option for translating 0 hp into injury instead of death, but the baseline assumption is that your hit points are merely an abstract measure of your chances of survival. Treasure them, and know when to say when.

Alternate Death Rules

If you'd like a smaller chance of character death, you can use this alternate set of death rules.

At 0 hit points, a character is unconscious for 1 minute. While they are unconscious, they can be slain by any foe that attacks them. Any amount of healing, either from overnight rest or magic brings them to a conscious state.

If a character is driven to less than 0 hit points they must pass a saving throw vs. death or die instantly. If they survive, they are still unconscious and wounded. They remain unconscious until their hit point total is brought back to 1 or more. Moreover, they must roll on the following table to determine their wounds.

d10	Grievous Wound
1-4	Gruesome Scars—1 point of charisma drain
5	Blindness—as condition
6	Deafness—as condition
7	Mangled Limb—1 point of dexterity drain
8	Chest Trauma—1 point of constitution drain
9	Severed Limb—determine limb randomly; 2 points of strength drain and possible crippled
10	Head Injury—2 points of intelligence, wisdom or charisma drain (determine randomly)

The *heal* spell removes grievous wounds other than severed limbs, as well as healing hit point damage. *Cure* spells return lost hit points, but do not remove grievous wounds. Other spells may be able to remove grievous wounds as determined by the TK.

Ability Score Damage and Drain

Ability scores can be damaged by poison, disease, severe injuries (see above) and other special attacks. When ability points are lost, this damage is deducted from the character's current ability score. The character's new ability score now determines their ability modifier. In the case of a constitution score going down, any bonus hit points gained from the old bonus must be recalculated using the new bonus. For example, a character with an 18 constitution gets a bonus of 3 hit points per level. If that constitution were reduced to 10, the character would lose those 3 bonus hit points per level. This reduction in hit points can cause death.

If a character's new ability score does not permit them to take levels in their current class, for example a sorcerer's charisma dropping below 9, they do not lose their class abilities, but cannot advance in that class or earn XP until their ability score has been restored.

Ability drain is permanent ability damage that cannot be healed without the use of powerful magic spells like *restoration* or *wish*.

Energy Damage and Drain

Some undead can drain a character's life energy. This takes the form of losing class levels or Hit Dice. In some cases, this loss is temporary (e.g. energy damage), but in most cases it is permanent. The character is reduced by one level or Hit Dice and all benefits derived from that level/HD are lost, including additional hit points (deduct a Hit Dice worth of hit points), spells learned or prepared, special abilities, saving throw and attack bonuses.



The character's experience point total is adjusted to be just high enough to qualify the character for their new lower level. Temporary energy damage usually lasts for 1 day, the lost level returning after a night's rest.

Healing

Characters naturally heal a number of hit points equal to their level/Hit Dice each night when they sleep for 6 to 8 hours uninterrupted. This is in addition to any magical healing the character might receive.

With each night of rest, a character also regains one ability score point lost to ability damage. If the character has lost ability score points from multiple abilities, the player must choose which ability score is healed that night. For example, a character that has lost 2 points of strength and 1 point of constitution could, after a night's rest, regain 1 point of strength or 1 point of constitution, but not 1 point of each.

TKs who want to extend the "adventuring day" might also choose to allow characters to regain some of the hit points they have just lost by resting after the battle. If characters rest for 30 minutes after a battle, they can regain half of the hit points they just lost in that particular battle, but not hit points lost earlier. While resting, they cannot engage in any physically or mentally taxing tasks, and they must have water or some other liquid that they can drink.

Strongholds and Domains

When characters have advanced to a high level they are among the most accomplished people in the land. They should have access to large amounts of treasure and are beginning to find very little left to do with it. Perhaps they have created some long-term relationships with NPCs in the campaign world and have a desire to settle down. When this urge to own land strikes a player, it is time to begin the process of building a stronghold and establishing a domain. This requires the following steps:

- 1) The character must clear an area of wilderness of monsters so that it is safe for non-adventurers to move in. The wilderness area must be at least 100 miles away from the nearest settlement
- 2) A site for the stronghold must be found. The site should have access to stone that can be quarried, trees that can be cut, a relatively level area for the stronghold and access to a waterway for transportation.

- 3) Once the area is cleared and a site found, the character must design and build a stronghold.

- 4) When the stronghold is built, the character attracts followers and peasants to settle the land.

Selecting a Domain

The first step in establishing a domain is to select the location. If the TK has not developed a campaign map this really cannot take place. Campaign maps are not necessary for *Blood & Treasure* adventures, but they are required for high level play that involves settling down and building strongholds.

Assuming there is a campaign map, the prospective lord must select a piece of land at least 100 miles into the wilderness and away from existing settlements. If this land is claimed by somebody else, conflict may occur, or the new lord may petition the claimant for a piece of his domain, promising in return to serve as his loyal vassal. This NPC is the player character's liege lord.

A third option is to conquer the domain of an existing noble. Remember, though, that nobles exist in a web of alliances and obligations with other nobles, from the lowliest knight to the most powerful emperors. Unless the target is completely independent, a war of conquest carries severe repercussions.

A new domain needs to contain at least 100 acres. The domain should be fertile and should have a ready water supply in the form of a river, stream or spring.

Clearing the Domain of Monsters

The site of a new fief or independent settlement is considered to be cleared of monsters if all monster lairs within 10 miles have been sought out and destroyed, and any survivors of those lairs sent beyond the 10 mile boundary. This state of affairs must persist for an entire year before peasants are ready to settle in the new fief as tenants or before the adventurer's liege is willing to send serfs to dwell on his domain.

Seeking out these lairs and destroying them can be the basis of many adventures. The prospective lord must support his retinue in the wilderness while the campaign of monster eradication is carried out.

Designing a Stronghold

Once the land has been cleared of monsters, a temporary fort must be built to give workers some sense of security. New lords might want to start with a simple motte-and-baily construction consisting of a moat, a wooden palisade and sufficient structures and tents to house himself, his retinue and the craftsmen and workers needed to build the actual castle. This small construction is not enough to attract peasants.

Before the castle can be built, the player must design it, drawing out a plan using graph paper. The stronghold is composed of several "construction units" listed below. Each unit carries with it a cost in gold pieces. A unit takes 1 week per 20 gold pieces of the module's cost per man working on it to complete.

Thus, a 10-ft section of outer wall, which costs 500 gold pieces, would take one man 25 weeks to complete. A crew of 10 men could complete it in 2.5 weeks. Dwarves and hobgoblins are especially good at construction projects, and can complete 30 gp of work in 1 week. Goblins, halflings, gnomes and kobolds are good at excavations, and can do 30 gp worth of work in 1 week.

Excavations

An excavation unit is 5 cubic feet of earth. The excavation's price and construction time depend on the material being excavated and whether the final excavation has a ceiling and whether it is reinforced with wooden or stone pillars.

Soil or Gravel	5 gp
Soft Rock (basalt, limestone, sandstone)	20 gp
Hard Rock (granite)	50 gp
Ceiling	x2
Ceiling and Reinforced with Wood	x3
Ceiling and Reinforced with Stone	x4

Walls

Walls are put up in 10' x 10' sections. The price and construction time depend on the thickness of the wall and the materials used. The top of outer and inner walls are assumed to have crenellations.

Outer Wall (10' thick)	500 gp
Inner Wall (5' thick)	200 gp
Interior Wall, Stone (1' thick)	30 gp
Interior Wall, Wood (6" thick)	10 gp

Buildings

This category includes towers, keeps and cottages. Buildings are built one floor at a time in 50 square foot sections. The cost and construction time depend on the materials used on the exterior wall. Round buildings cost 150% as much as rectangular. All floors are assumed to be wood. Assume that stairs are included with multi-floor structures. Roofs are purchased separately.

Wattle-and-Daub	20 gp
Wood/Timber	50 gp
Stone (1' thick)	150 gp
Stone (5' thick)	1,000 gp
Thatched Roof	10 gp
Tile Roof	50 gp
Stone Roof	100 gp
Crenellations	100 gp

Portals and Windows

Door or Trapdoor, Simple Wooden	1 gp
Door or Trapdoor, Good Wooden	2 gp
Door or Trapdoor, Strong Wooden	3 gp
Door or Trapdoor, Iron	6 gp
Door or Trapdoor, Secret	10 gp
Portcullis, Wooden	20 gp
Portcullis, Iron	50 gp
Draw Bridge	200 gp
Window, Shuttered	5 sp
Window, Glass	10 gp
Window, Stained Glass	100 gp
Arrow Slit	5 sp

Accoutrements and Ornaments

Dais	50 gp
Fancy Stone	x10
Fireplace, small	20 gp
Fireplace, grand	50 gp
Fountain, Small	50 gp
Fountain, Large	500 gp
Statue, Small	50 gp
Statue, Medium	100 gp
Statue, Large	200 gp
Statue, Huge	400 gp
Trap	Varies

The TK should dice for random monster encounters during construction to keep things interesting.

Taxes

Once the stronghold is constructed, the lord can finally attract peasants to work the land and begin collecting rents. The lord attracts 1 peasant family per 20 acres of arable land that he has cleared.

Peasant rents are always in the form of a percentage of their agricultural produce. For each peasant family working the lord's lands, roll once per harvest season on the following table:

d20	Rent Collected
1-7	1d6 x 100 lb. of grain, worth 1 cp per lb.
8-10	1d4 x 100 lb. of fruit, worth 1 sp per lb.
11-13	2d6 chickens, worth 2 cp per chicken
14-15	1d4 x 100 lb. of wool, worth 5 sp per lb.
16	1d10-1 head of goat, worth 1 gp per head
17	1d8-1 head of sheep, worth 2 gp per head
18	1d6-1 head of swine, worth 3 gp per head
19	1d3-1 head of cattle, worth 10 gp per head
20	1d2-1 head of oxen, worth 15 gp per head

For each peasant family working a mine, the lord collects 1d6 x 100 lb. of base metal per year, 1d6 x 10 lb. of precious metal per year or 2d6 valuable gemstones per year in rent.

If the lord has taken on any vassals or yeomen, they pay a rent equal to 1d10 sp per acre they work per month to the lord. If he has permitted smiths, millers and other professionals to set up shop on his land, the lord collects a rent of 1d6 gp per month from them.



Domain Events

Each month, the TK should roll 1d6. On a roll of "1", a random event occurs. Determine the event on the table below by rolling d%.

d%	Event
1-10	Yeoman family arrives looking for 20 acres
11-18	Yeoman family departs. Leaves 20 acres fallow
19-24	Artisan and his family arrive looking for work
25-30	Artisan and his family depart
31-34	NPC (1d4+1 level) wishes to pledge his loyalty to the lord or lady in exchange for 40 acres of land
35-40	Vassal and his family depart
41-46	3d6 pilgrims arrive expecting hospitality
47-49	Chaotic humanoids attack
50-54	Human or demi-human lord and 2d6 followers arrive with gifts looking for hospitality for 1d4 weeks
55-60	Enemy army invades
61-63	Undead monster stalks the domain creating spawn
64-66	Powerful monster makes lair in wilderness
67	Ill weather ruins crops; no agricultural rents this year and food must be imported to keep people alive; the weather may be caused by a monster or spellcaster
68-69	Liege demands the lord and his troops march to war
70-74	Diplomat from adjacent fief offers an alliance or demands satisfaction for a real or imagined slight
75	Earthquake damages castle; maybe caused by monster or spellcaster
76	Comet brings bad fortune until a difficult pilgrimage is taken to the nearest holy site
77	A member of the family or retinue dies mysteriously
78-80	A vein of minerals is discovered in the domain* by the lord's agents or by prospectors who work it in secret
81-85	Bandits plague the domain, hiding in the wilderness
86	Pregnancy in the family
87-91	Traders bring exotic goods and news of the world
92-96	Entertainers arrive (might be spies or assassins)
97	Inhabitant of domain receives a mysterious vision
98	Assassination attempt; assassin has same level as target
99	Lord or a member of family or retinue is cursed by an evil spellcaster or monster
00	Valuable item is stolen or a member of the lord's family or retinue is kidnapped

* Roll 1d20 to determine mineral: 1-12 = base metal, 13-14 = copper, 15 = silver, 16 = gold, 17 = platinum, 18 = baubles, 19 = gems, 20 = jewels

Mass Combat

When a lord or lady finds it necessary to go to war, the normal rules for combat may become untenable. If so, you can instead use these rules for mass combat. They are based on the normal combat rules, but adjust them to take into account the larger number of combatants.

Squadrons

To keep things simple, groups of combatants are divided into squadrons of 10 figures each. The squadron is the basic unit for fighting, and in mass combat a squadron attacks as though it were a single creature. Thus, a squadron of dwarves would make a single attack on its turn, while a squadron of lizardmen could make both a weapon and a bite attack.

A squadron has as many hit points as its collective members have Hit Dice. Thus, a squadron of 10 dwarves, who have one HD each, has 10 hp. For mass combat, 0 HD troops are counted as ½ HD.

Huge monsters, some large monsters such as giants and dragons, and siege engines are treated as units.

Squadrons can be grouped into larger units, as follows: A company consists of two squadrons, a battalion of four squadrons and a regiment of eight squadrons.

Each squadron is assumed to form a single rank of troops on the battlefield. A squadron of men-at-arms therefore consists of 10 men-at-arms standing in a row. A company of men-at-arms could either consist of 20 men-at-arms standing in a row or two ranks of 10 men-at-arms. It is necessary to note the number of ranks in each unit, as this plays a role in mass combat.

Only the front rank of troops can attack unless they are armed with polearms or spears, in which case the second rank can attack. If they are armed with pikes, both the second and third ranks can attack. If they are armed with ranged weapons, every rank can attack targets that are at least 30 feet away.

Some sample units follow:

Ogres—Squadron (1 rank); HD 4 (40 hp); AC 16; ATK Heavy club 2d8 or Javelin 1d8; MV 100 yards; SV 15

Halberdiers—Company (2 ranks); HD 1 (20 hp); AC 15; ATK 2 Halberd 1d10; MV 100 yards; SV 16

Halfling Slingers—Battalion (1 rank); HD 0 (10 hp); AC 15; ATK 4 Sling 1d4 or 4 Short Sword 1d6; MV 60 yards; SV 17; Special—Halfling abilities

Orcs—Regiment (4 ranks); HD 1 (80 hp); AC 13; ATK 2 Falchion 2d4 or 8 Javelin 1d4; MV 100 yards; SV 16

Leaders

Leader-types, creatures with more HD than normal for their creature type, creatures with class levels or powerful monsters like medusas, can be used as units unto themselves, or integrated into units of lesser creatures. Any time a unit suffers damage, the leader must pass a saving throw or suffer the same amount of damage as his unit, gaining a +1 bonus to the save for every 10 figures that are in his or her unit.

Units cannot direct their attacks specifically against a leader who is integrated with a unit. Only leader-types or powerful monsters can target such a figure.

Leader-types attack separately from units in which they are included. If they target another leader or powerful monster, run this combat just as though you were handling a normal melee. If they are directing their attack against a unit, they inflict damage on that enemy unit based on their total attack bonus, including ability bonuses and bonuses due to magic weapons or spells.

Attack Bonus	Damage vs. Target Unit
+0 to +6	Half normal weapon damage
+7 or higher	Normal weapon damage

Mounted Squadrons

A mounted squadron's hit points are equal to the HD of the warriors and the mounts combined.

Both warrior and mount can attack each round.

Saving throws against spells have to be passed by both the rider and the mount to be successful. If either fails, the unit suffers the effects of the spell. Morale saves are only made by the rider.

Order of Battle

Mass combat is conducted in 1 minute rounds. It uses the following order of play:

1) Orders Phase: In this phase, each unit is given its orders. Once the orders are given for a round, they cannot be changed, although they can be disrupted by events on the battlefield. In other words, once the

command has been given for a company of orcs to march up a hill, they cannot change their mind when a company of knights gets there first. Naturally, orders are given without each commander knowing the commands of his opponent.

After orders are given, each commander rolls 1d6 for initiative order during that phase. The high roller goes first in each subsequent phase. If the rolls are a tie, roll the dice again.

2) Missile Phase: Missile-armed troops shoot their missiles if they did not move during the last movement phase.

3) Movement Phase: Units move in the direction and at the speed they have been ordered. Units within 10 yards of an enemy unit cannot move at faster than combat speed (i.e. half normal speed). Units can also change formation during this round (see below). Note that mass combat uses 1 minute rounds, so adjust movement rates of units accordingly.

4) Melee Phase: Opposing units that have come into

contact with one another fight a round of melee combat.

5) Magic Phase: Spellcasters cast spells. Spellcasters can generally cast one spell per round, unless the normal casting time is longer than one minute.

6) Morale Phase: Units check morale as needed.

After the Morale Phase, play returns to the Orders Phase.

Formation

A unit can change its number of ranks during combat by forgoing a normal move. A unit can also switch between two general formation types, tight and loose.

A unit in tight formation gets none of the benefits or penalties that a loose unit does, and is thus the default formation for all units in the game.

A unit in loose formation enjoys a +2 AC bonus against missile attacks. It suffers a -2 penalty, however, on AC vs. melee attacks and a -2 penalty on morale checks.



Attacks and Damage

As mentioned above, each squadron in a game can attack as though it were a single creature of the same type using the same attack rules used in normal combat (see above). Each successful attack by a squadron, using spells or weapons, rolls normal damage against its target.

A unit can suffer no more hit point damage from a melee attack than it exposes in its first rank. Thus, a unit with 10 normal humans (1 HD each) in its first rank can suffer no more than 10 points of damage from a melee attack. If it is being attacked by ranged weapons, there is no limit to the damage it can sustain.

Units can bull rush an opposing unit in combat, gaining a +1 bonus to their attack roll for every additional rank it has over the opposing unit. If successful, it pushes the opposing unit back 5 yards.

A unit gains a tactical advantage when attacking another unit from the flank or rear. The flanked unit cannot counterattack during that round, as it has to make a special maneuver to wheel and face its attackers.

Morale Checks

Four events can force a unit to check morale.

- 1) When a unit has lost half or more of its hit points.
- 2) When a unit that has already lost half or more of its hit points suffers additional hit point damage.
- 3) When it is subjected to a magic fear effect.
- 4) When a unit's leader is killed.

When a unit must make a morale check, it rolls a saving throw using either its own save value or its leader's.

If a unit succeeds on this save, it continues to fight. Otherwise, it immediately flees from enemy troops at running speed. If it was engaged with another unit, that unit gets a free attack with a tactical advantage.

During each movement phase, the unit commander can attempt to rally the troops with a new saving throw modified by his or her Charisma modifier. If successful, the unit spends one round reforming and can then move and attack on the next round. After two full rounds of fleeing, the unit disintegrates and ceases to exist.

Siege Engines

Siege Engine	Cost	Damage	Range	Reload	Crew	Strength*	AC	Weight
Ballista	500 gp	3d8	400 yards	½ turn	2	+3	16	1,000 lb.
Basilisk	2,000 gp	10d6	500 yards	3 turns	5	+8	22	4,000 lb.
Cannon	3,500 gp	20d6	500 yards	4 turns	6	+14	24	6,000 lb.
Cannon, siege	5000 gp	5d6 x 20	700 yards	1 hour	20	+16	30	37,000 lb.
Culverin	2,500 gp	12d6	500 yards	3 turns	5	+10	24	4,000 lb.
Falcon	900 gp	7d6	500 yards	2 turns	4	+5	20	660 lb.
Mangonel	550 gp	12d6	150 yards	1 turn	3	—	—	20,000 lb.
Minion	950 gp	8d6	500 yards	2 turns	4	+7	20	1,000 lb.
Ram	1,000 gp	3d8	—	—	—	Varies	18	4,000 lb.
Ribauldequin	1,000 gp	1d12 (10)	150 yards	4 turns	5	+1**	18	2,000 lb.
Serpentine	2,500 gp	10d8	500 yards	3 turns	5	+12	22	6,000 lb.
Siege tower	2,000 gp	—	—	—	20	—	—	—
Trebuchet	800 gp	10d8	150 yards	2 turns	5	—	—	40,000 lb.

Naval Units

Naval Weapon	Troops	Strength	Weapon AC	Range	Weight
Archers*	10	+1	16	70 yards	2,000 lb.

*Used for naval combat; includes all missile-armed troops

**Can only be used against crew

Siege Engines

Siege engines are large weapons, temporary structures, or pieces of equipment traditionally used in besieging a castle or fortress. In mass combat, each engine and its crew count as a single unit.

Siege engine attacks against land targets are made by rolling 1d20 and adding the engineer's intelligence modifier. For trained engineers add +5 to the roll. For magic-users with knowledge of geometry, add their level to the roll. If the roll is higher than '20', a hit is scored and damage may be rolled. For naval battles, use the special rules in the Naval Combat section below.

The *ribauldequin* is a wheeled platform holding 10 muskets that are fanned out and which are set off with a single match. They are useful for attacking people, rather than walls. When set off, they create a cone of bullets 150 yards long and 75 yards wide at the base. All within the area of fire must pass a save or suffer 1d6 damage.

On land, rams are heavy poles suspended from movable scaffolds that allow the crew to swing it back and forth against objects. The character closest to the front of the ram makes an attack roll against the Defense Rating of the construction. In addition to the damage given on the table above, up to nine other characters holding the ram can add their strength modifiers to the ram's damage. It takes at least one huge, two large, four medium, or eight small creatures to swing a ram. Tiny creatures cannot use a ram. A ram is typically 30 feet long. At sea, they are on the front of ships.

Siege towers are massive wooden towers on wheels or rollers that can be rolled up against a wall to allow attackers to the top of the wall with cover. The wooden walls are 1' thick. The tower takes up a space 15' wide and deep. The eight creatures inside the tower push it at a movement rate of 10'.

Ships

Type	Size (t)	Move	Dex	Crew	Arms	Armor Class			
						Hull	Sail	Oars	Crew
Caravel	400	230 yd.	+1	40	Falcon [1], Archers [1], Marines [1]	24	15	-	18
Carrack	500	160 yd.	+1	80	Falcon [2], Archers [1], Marines [2]	25	18	-	20
Cog	300	260 yd.	+0	30	Marines [1]	23	15	-	13
Galleass	400	200 yd.	+1	80	Ram +8, Falcon [1], Archers [1], Marines [1]	24	20	20	15
Galley	200	130 yd.	+2	30	Ram +6, Marines [1]	22	10	15	13
Galleon	1,000	260 yd.	+2	250	Ram +6, Marines [1]	26	10	15	13
Keelboat	25	300 yd.	+1	20	Marines [1]	18	10	10	15
Longship	50	260 yd.	+1	30	Marines [1], Archers [1]	20	10	15	18

Destroying Walls

Walls are given a Defense Rating based on their composition and thickness. When a siege weapon targets a wall, there is no need to roll to attack. Roll damage and subtract the wall's Defense Rating. The result is the percentage chance that the wall has been breached. The size of the breach is a radius equal to the damage roll in feet. There is a 2 in 6 chance that the breach is in the upper half of the wall.

Destroying Walls

Wall	DR
Earth, packed	10
Wood	15
Wood and packed earth	20
Stone (5' thick)	25
Stone (10' thick)	30
Stone (20' thick)	40

Naval Combat

Modeling battles at sea can be difficult, and is thus kept abstract. Before we get to the rules, we should examine the different ship types in the game and their combat statistics. Note that rafts, barges and keel boats are not really combat vessels, and combat between them is really between missile-armed troops on each vessel.

Naval Combat Procedure

Combat begins with each ship captain rolling to gain advantage. Each captain rolls 1d6 and adds the ship's dexterity modifier (see below).

The captain that has the advantage can choose to close or increase the distance between the two vessels by a number of feet equal to its speed. The captain with the advantage also makes the first attack in the action phase.

After the captain with advantage has moved, each captain can make one attack per weapon, beginning with the captain with the advantage and each captain then taking turns until all their weapons have been fired.

For each weapon, the captain gives an order and rolls 1d20, adding the weapon's strength. If the roll is equal to or higher than the target area's AC, the effects of the order are carried out.

The possible orders are as follows:

Clear the Deck (vs. Crew AC): Weapon targets the crew on the main deck. Success reduces the target to a skeleton crew (25% of normal), reducing the ship's dexterity modifier by 4. Crew can only be attacked at a range of 60 feet or less.

Grapple and Secure (vs. AC 10): Crew attempts to grapple the enemy ship and begin a boarding action. Normal sailors can make a grapple attack at +0, while archers and marines make the attack at their normal attack bonus. Success brings the boats together and the boarding action begins. Boarding actions are handled with normal or mass combat rules depending on how many combatants are involved.

Rake the Sails (vs. Sails AC): The weapon targets the sails. Success reduces the dexterity modifier by 2 and the ship's speed by 50%. Ships that are powered by both sails and oars cut these penalties in half.

Silence Those Guns (vs. Weapon AC): The weapon targets one weapon of the opposing vessel. The target weapon's Armor Class is used to resolve the attack. Success destroys the weapon.

Send them to the Bottom (vs. Hull AC): The weapon targets the ship's hull, attempting to hit it at the waterline or cause the power magazine to explode. With success, the target ship sinks in 1d10 turns.

Snap Those Oars (vs. Oars AC): The ship targets the other ship's oars. If successful, the target's dexterity modifier is reduced by 2, its speed is reduced by 50% and ramming attacks are made at a -2 penalty to attack.

Failed Attacks

A failed weapon attack on a hull, oars or sail that fails can still have an impact. If the attack does not fail by more than 5 points, roll on the following table.

d%	Effect
1-30	None
31-39	Flying splinters; all PC's suffer 1d10 points of damage
40-49	10-40% of cargo destroyed
50-59	Anchor hit and lost to the depths
60-69	50% of foodstuffs (and rum) lost; the rest is lost next round if somebody doesn't douse that fire!
70-79	Fire on deck! All PCs on the main deck suffer 1d6 points of fire damage each round until doused
80-84	One weapon crew confused, cannot attack next round
85-89	Random PC is thrown overboard with 1d4 crew
90-94	Important documents destroyed by shot or fire
95-99	The ammunition supply / powder magazine floods, leaving the vessel with only enough for 5 more rounds of combat
00	A random officer or PC is struck, taking 3d6 damage

Combat continues until one ship is destroyed or captured, or the distance between the two ships has been increased to 3,000 feet or more.

Spellcasters can make attacks as above with spells that deal damage, the attack bonus of the spell being equal to its spell level. Adjudicate other spells as needed.

Example of Play

The following example of play might be useful to new Treasure Keepers and players, as it shows a snippet of a typical session of *Blood & Treasure*. In this sample of play, five players are delving into a dungeon beneath an abandoned gatehouse. The players are playing first level characters: **Bardra** the Human Barbarian, **Forglum** the Human Fighter, **Knurri** the Dwarf Cleric, **Tulla** the Half-Elf Thief and **Merlyn** the Human Magic-User. Play begins with the TK explaining to the players what they see as they approach the gatehouse.

TK: The gatehouse is composed of two towers. One of those towers is completely crumbling and overgrown with vines, while the other is intact. The intact tower has four interior floors, one of them a cellar, not including the roof. Between the towers is the remains of a bridge, which leads across an empty moat to the rubble of the castle beyond. At the base of this bridge there is a small tunnel entrance. Behind the intact tower, there is an entrance into the tower.

Merlyn: We've decided to go underground first. The tower seems to be empty.

TK: The tunnel entrance is not barred. It leads into a small room, maybe 6 feet by 6 feet, with a ceiling about 5 feet in height. Everyone but Knurri feels cramped in here.

You see a bit of trash and rubble in here, and in the far right corner a wooden trapdoor.

Tulla: I'll investigate the trapdoor for traps – any thin wires attached to it – that sort of thing.

TK: What's your "find traps" target number?

Tulla: I need a 14 or better.

[There are no traps, but the TK needs to roll 1d20 in secret.]

TK: Tulla finds no traps on the door – it appears to be safe.

Knurri: Since I have darkvision, I'd better go first. You can follow with your torches. I'll open the trapdoor.

TK: You see a shaft leading down into the ground. The shaft is clad in rough-hewn stone and appears to descend about 30 feet. There is a rusty, iron ladder attached to one side of the shaft.

Knurri: Okay, with warhammer in hand, I'll slowly descend the ladder. I'll make reasonably sure it is strong before I put my full weight on it. When I get to the bottom, I'll motion the others down. We'd better just go down one at a time.

TK: At the bottom, you find yourself in a vaulted tunnel clad in bricks. The tunnel goes about 30 feet to the south and ends in a wooden door, and about 40 feet to the north, where it ends in a T-section going east and west.

[Rolls 1d6 to check for random encounters and rolls a "3" – no encounter]

The floor is damp and somewhat uneven, and it smells musty and ancient. I assume the others are now climbing down now. Could I get the order?

Forglum: I'll go first, dagger and torch in hand, two-handed sword slung on back. Merlyn will follow me, then Tulla, Bardra and finally Knurri.

TK: You all get down without trouble. What next?

[The players discuss their options, and decide that Tulla will check the door while Forglum and Bardra cover her with their crossbows. Knurri will watch their rear. Merlyn is holding their torch.]

Tulla: First, I'll check the exterior of the door as well as its frame and the ground in front of the door for traps. If it appears safe, I'll listen at the door. If I hear nothing, I'll

check the door's lock for a needle trap and then see if the door is unlocked.

[The TK now rolls to see if she is successful. He knows that there are 6 kobolds behind the door, for this is a guard post to a kobold lair. The only trap on the door is a poisoned needled in the lock. First, he makes a dummy roll for the first trap check. Then, he rolls for listening at the door and gets an "11", so Tulla hears nothing. Finally, he makes a find traps roll for Tulla's attempt to find a needle trap in the door. This is a tiny trap, so there is a -2 penalty on the roll. He gets a "17", indicating that she has found the trap.]

TK: Tulla finds no traps around the door. She presses her ear to the damp, chilly wood and waits a good two minutes, but hears nothing on the other side. Having the mage move closer with the torch, she uses her tools to check the lock for a poisoned needle, and finds one. She also finds that the door is locked.

Tulla: I'll attempt to remove the poisoned needle, and then very quietly pick the lock.

[Again, the TK makes the rolls. The roll to disable the trap is a "19", so she is successful, even though there is a difficulty in the trap being so small. The lock is not especially difficult, and he rolls a "17" for her open locks check, good enough by a large margin, so he decides she does do it quietly.]

TK: You succeed in disabling the trap and in picking the lock very quietly.

[The players now discuss tactics, and decide that Forglum, being the most heavily armored, in chainmail, should be the first one in. He'll be followed by Bardra and then Knurri. Merlyn will be next, and Tulla will lurk behind so she has a chance to hide in shadows and maybe score a backstab. The TK rolls now for the chances of surprise. He decides that the party is ready for trouble, but that the kobolds might be surprised. He rolls 1d6 and gets a 3 – indicating that the kobolds are not surprised. On a roll of 1 or 2, the kobolds would have been surprised.]

TK: Forglum steadies himself, and then throws open the door to find six kobolds occupying the room. They have shields and spears, and though they were not expecting you, they were on alert and are ready for battle.

[The TK now asks one player to roll 1d6 for initiative. He rolls 1d6 for the kobolds and gets a "4". The players roll a "5" and so have the initiative.]

TK: You guys have the initiative. What are you doing?

Bardra: Can I throw my hand axe over Forglum's shoulder at one of the kobolds?

TK: I'll allow that, but because Forglum is in the way, the kobold has a tactical advantage, so I'm increasing his AC by 2. That gives the kobold an AC of 14.

Bardra: I roll a 13, but with my strength bonus of +2 it's a 15. I hit.

TK: Hold on – for ranged attacks you add your dexterity modifier, not strength modifier.

Bardra: Sorry – dexterity modifier is a +1, so the roll is a 14. I still hit. I now roll 1d6 plus my strength bonus for damage and get a ... 5.

TK: The axe cleaves the kobold's skull and kills it.

Knurri: Well, I'm stuck behind the two giants, so I can't attack. I will, however, cast *bleed* on everyone. You all have a +1 to attack and a +1 on saving throws against fear for 1 minute ... uh, 6 rounds.

Forglum: I'll attack the kobolds. Against 0 HD monsters I can make two attacks, and I roll "19" and "22" – oh, and that was a natural '20', a critical hit. Instead of doing an extra dice of damage, I'll treat it as a disarm attack. I roll "11" and "6" for damage.

TK: Both kobolds are killed, so the disarm doesn't count.

Merlyn: We've already killed three of the kobolds, so I don't want to waste my *sleep* spell. I'll just stay out of the way for now.

Tulla: Same here – there's no room to maneuver yet.

TK: Okay. There are still five kobolds left. I'm going to rule that three of them can attack Forglum, since they're small creatures and are using spears. Since they're one size smaller than Forglum, he has a tactical advantage against them and increases his AC by 2 this round, to 17. They don't technically flank him, since he's in the doorway, or they'd cancel that advantage out. Anyhow, they roll a "19", "15" and "5" [kobolds are 0 HD monsters, so they add 0 to their attack rolls], hitting Forglum one time for [rolls 1d6] ... a big 6 points of damage. He only has 7 hit points to begin with, so he's down to 1 hit point!

Forglum: Damn. I hope Knurri can heal me next round.

TK: Let's roll initiative for the second round of combat.

[The adventurers win initiative again this round]

Knurri: I'll cast *cure light wounds* on Forglum – it's a good thing I have such a high wisdom score, or I wouldn't have an extra 1st level spell. I roll a "3". That returns 4 hit points to Forglum.

Merlyn: I don't want Bardra getting the same treatment as Forglum. I'll cast *daze* on one of the kobolds.

[The Treasure Keeper rolls 1d20 for the kobold's saving throw and gets a "6"]

TK: One of the kobolds is dazed – he gets no attack this round.

Tulla: Well, I'm still stuck in the back. I'll watch the other corridor for now, in case something tries to surprise us.

Forglum: Thanks Knurri. I'll hold my action until Bardra has gone – maybe she can force her way into the room.

Bardra: I'll try. I attempt to bull rush the kobolds. I roll a "9", plus my attack bonus of +1 and my strength bonus of +2, I get a "12". Oh – I also get a tactical advantage becomes I'm bigger – so it's a "14".

TK: Sorry, not good enough.

[Since half the kobolds have been killed, the TK rolls a morale check (saving throw) for the remaining kobolds. He rolls an "11", indicating that the kobolds have lost their will to fight and are prepared to surrender or flee.]

TK: That means it's the kobolds turn. There are three left, and one is dazed. The other two decide they've had enough and throw down their weapons, surrendering to you. You now have a better view of the room. It looks like a converted root cellar, with some sleeping pallets of straw and rags in the corners, a couple old barrels, and a second door in the opposite wall.

[At this point, the players must decide what to do with the kobolds and then whether or not they want to dare opening the other door.]



Spells

5

Magic spells are the meat and drink of many fantasy stories, and are the primary means of affecting the fantasy world for several classes and monsters.

Preparing Spells

All spellcasting classes other than the sorcerer have to prepare the spells they are going to cast before they cast them.

To prepare spells, a spellcaster must have had a full night's sleep (6 to 8 hours). Magic-users and bards must have their spellbooks, and clerics, druids, paladins and rangers must have a holy symbol or idol handy.

Total the levels of the spells the caster wishes to prepare. This is the number of minutes of time it will take them to prepare those spells.

Advanced Spells

Most of the spellcasting classes have spell lists divided into basic and advanced spells. Basic spells are easy to understand, while advanced spells take a bit more work.

When magic-users wish to add an advanced spell to their spellbook, they must roll a number equal to or lower than their intelligence score minus the level of the spell they wish to learn on 1d20.



When sorcerers wish to add an advanced spell to their list of known spells, they must roll a number equal to or lower than their charisma score minus the level of the spell they wish to learn on 1d20.

When clerics, druids, paladins and rangers wish to prepare an advanced spell, they must roll a number equal to or lower than their wisdom score minus the level of the spell they wish to learn on 1d20.

Spellbooks and Scrolls

Recording a spell in a spellbook takes 24 hours per spell level, regardless of the spell's level. A spell takes up one page per spell level. A normal spell book has 100 pages, and thus can hold about 100 levels of spells.

Captured spell books can be sold for a gold piece amount equal to half the cost of purchasing and inscribing the spells within (that is, 50 gp per page of spells). A spell book completely filled with spells is thus worth 5,000 gp.

Magic-users and bards cannot read another caster's spellbook or scrolls without casting *read magic*. Once it is deciphered thus, it is understood and can be prepared, cast (from a scroll) or recorded in a spellbook.

To record a spell in a spellbook takes one day per spell level and costs 100 gp per spell level for the special inks. Copying a spell from a scroll removes it from that scroll, leaving it a non-magical piece of parchment. Copying a spell from a spellbook does not remove it from the book.

Casters charge the same fee to copy a spell from their spellbook as they charge a customer for casting that spell, though they might instead ask for a favor in lieu of money, or offer to trade spells of similar power.

Spell Level	Cost to Copy or Cast
1st	100 gp
2nd	250 gp
3rd	500 gp
4th	1,000 gp
5th	2,500 gp
6th	5,000 gp
7th	10,000 gp
8th	25,000 gp
9th	50,000 gp

Creating and Researching Spells

All spellcasters except paladins and rangers can create new spells. Creating a new spell or researching and learning an existing takes 1 week per spell level and costs as much as it would cost to have the spell cast (see the table above). For new spells, the TK determines its level based on what it can do.

Creating and researching spells does not always succeed. The base chance of success is 10% + 1% per level of the spellcaster + 1% per point of intelligence (magic-users and bards), wisdom (clerics and druids) or Charisma (sorcerers) minus 2% per level of spell. If the researcher is aided by a sage, their chance is improved by +3%.

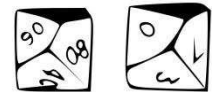

If the roll is successful, the character may add the spell to his or her spellbook (or to "spells known" in the case of a sorcerer, and assuming they have free slots open for new spells) or they may be prepared by a cleric or druid.

If the roll fails, the money and time spent are wasted. The spellcaster may not attempt to research that particular spell again until they have gained a new level.

Casting Spells

Spells can be cast and take effect in a round unless otherwise noted in description

Casting a spell requires one to be able to speak, move their arms, hands and fingers and sometimes to have a spell component that is consumed by the spell (i.e. it goes away when the spell is cast) or a focus that does not go away when the spell is cast

- A silenced caster cannot cast spells
- A paralyzed caster cannot cast spells
- A caster without the proper component or focus for the spell cannot cast the spell
- A deafened caster has a 50% chance to cast a spell; if the roll fails, the spell is lost from memory
- A bound caster cannot cast spells

If damaged in combat before a spell can be cast, a caster must pass a saving throw or the spell is lost.

Spell duration depends on the spell

Spell range depends on the spell

Saving Throws and Magic Resistance

An unwilling target of a spell always gets a saving throw to negate the effects of the spell or to cut damage from the spell in half.

Some monsters have “magic resistance”. This is the percentage chance that a spell cast has no effect on the monster. Conditions and effects caused by a spell but not actually part of the spell, such as an object dropped on a creature using *telekinesis*, are not affected by a monster’s magic resistance.

Area of Effect

The area affected by a spell is described in the spell’s description. Two areas of effect are worth explaining:

A **ray** targets a single creature within range. The target avoids the ray by making

a saving throw. No attack roll is required.

Missiles require a ranged attack roll to hit the target.

A **cone** originates from the caster. For simplicity’s sake, only the length of the cone is given in the spell descriptions. The width of the cone’s base is always equal to half the cone’s length.

Dismissing a Spell

A spell caster can always dismiss the effects of one of their own ongoing spells with a wave of their hand, snap of their fingers or wink of their eye.

Counter-Spells

If a caster has a spell prepared and notes that another caster is casting that spell (roll 1d20 equal to or below Intelligence for magic-users, bards and sorcerers or Wisdom for druids and clerics), they may counter-spell it by casting the same spell in reverse. This eliminates the counter-speller’s prepared spell, but also negates the enemy caster’s spell effect. This is done outside of the normal initiative order, but counts as the counter-speller’s action for that round.

Example: Merlyn the Magician sees an enemy caster casting a spell. Rolling 1d20 under his Intelligence score, he notes that the spell being cast is *lightning bolt*. Merlyn has this spell prepared, so he chooses casts the reverse, *tlob gninthgil*. Merlyn erases his prepared *lightning bolt* spell from his character sheet, and the enemy caster’s *lightning bolt* spell is ruined.



Spell Descriptions

Acid Arrow

Level: Magic-User 2

Range: 240'

You fire a magical arrow composed of acid at a single target. This requires a ranged attack roll to hit. The arrow deals 2d4 points of damage. The acid continues to inflict 2d4 damage per round for 1d6 additional rounds or until washed off with at least one gallon of water.

Acid Splash

Level: Magic-User 1

Range: 30'

You throw a small bit of acid at a target. This requires a ranged attack roll. If the acid orb hits, it deals 1d6 points of acid damage.

Aid

Level: Cleric 2

Range: Touch

Duration: 1 hour

Aid grants the target a +1 bonus to attack and save and 1d6 temporary hit points that disappear after one hour.

Air Walk

Level: Cleric 4, Druid 4

Range: Touch

Duration: 1 hour

The subject can walk on air. A strong wind can halt their forward movement.

Alarm

Level: Magic-User 1

Range: A 30' radius circle

Duration: 2 hours/level

Alarm sounds a mental or audible alarm (your choice) each time a creature enters the area or touches a waded object. A creature that speaks a password of your choosing does not set off the alarm. Ethereal and astral creatures do not trigger the alarm.

Alter Self

Level: Magic-User 2

Range: Personal

Duration: 1 hour

You make yourself look like a creature of a similar size and shape.

Analyze Dweomer

Level: Magic-User 6

Range: 30'

Duration: 1 minute

Each round, you can look at one creature or object. If it is a magic item, you learn its functions, how to activate it and how many charges (if any) are left. If it has spells cast on it, you learn what they are and the level of the caster who cast them. The spell does not function on artifacts.

Focus: Ruby or sapphire lens set in a gold loop (1,500 gp)

Animal Friendship

Level: Druid 1

Range: 30'

Duration: Instantaneous

The spell caster wins the loyalty of an animal, which lasts as long as it is treated well. The caster can have twice their level in Hit Dice of animal friends.

Animal Growth

Level: Druid 5, Magic-User 5

Range: 120'

Duration: 2 hours

This spell causes 1d6 animals to grow to twice their normal size. This doubles the animal's Hit Dice and adds +1d6 to its damage rolls. Additional magical effects that increase size do not affect the animal.

Animal Messenger

Level: Cleric 2, Druid 2

Range: 30'

Duration: One day/level

You compel a tiny animal to go to a place you designate to deliver a message. The animal must be able to reach its destination before the duration is over.

Animal Shapes

Level: Druid 8

Range: 30'

Duration: 1 day

As *polymorph* except that you change up to one willing creature per caster level into an animal of your choice. All must take the same animal form. The maximum Hit Dice of the animal form cannot exceed the Hit Dice of the

target or the caster's level, whichever is lower. The spell does not affect unwilling creatures.

Animal Trance

Level: Druid 2
Range: 30'
Duration: Concentration

You fascinate 2d6 HD worth of animals, who do nothing but watch you while you concentrate.

Animate Dead

Level: Anti-Cleric 3, Magic-User 4
Range: Touch
Duration: Instantaneous

You create 1d6 skeletons (from bones) or zombies (from corpses) under your command. If destroyed, they cannot be re-animated. You can only control 4 HD of undead per caster level at one time. If you are an anti-cleric, any undead you command by virtue of turn undead do not count toward this limit.

Animate Object

Level: Cleric 6
Range: 120'
Duration: 1 hour

You animate an object up to Huge in size. The object is under your command.



Animate Plant

Level: Druid 7
Range: 30'
Duration: 1 hour

You imbue an inanimate plant with mobility. It follows your commands. *Animate plants* cannot affect plant creatures, nor does it affect dead vegetable material.

Animate Stone

Level: Druid 7
Range: 120'
Duration: 1 hour

You imbue rock or stone object with "life". The stone follows your commands.

Animate Rope

Level: Magic-User 1
Range: 120'
Duration: 1 hour

You can animate a normal rope. You can give the rope one simple command each round. It can only entangle a creature or object within 1' of the rope. It cannot move like a snake, so it must be thrown near a target.

Antilife Shell

Level: Cleric 6, Druid 6
Area: 10' radius
Duration: 2 hours

An invisible bubble surrounds the caster, preventing the entrance of most living creatures. The effect does not work on constructs, elementals, outsiders or the undead. Forcing the bubble against a creature ends the spell.

Antimagic Field

Level: Magic-User 6
Area: 10' radius
Duration: 2 hours

An invisible bubble of force surrounds the caster. Spells and magical effects cannot pass through the bubble.

Antipathy

Level: Druid 9, Magic-User 8
Range: 30'
Duration: 1 day

You cause an object or location to repel either a specific kind of intelligent creature or creatures of a particular

alignment. The creatures feel an over-powering urge to leave the area or to avoid the affected item. A creature that makes a successful saving throw can stay in the area or touch the item but feels uncomfortable doing so.

Antiplant Shell

Level: Druid 4
Area: 10' radius
Duration: 2 hours

An invisible bubble surrounds the caster, preventing the entrance of animated plants and plant monsters. Forcing the bubble against creatures ends the spell.

Armor of Darkness

Level: Anti-Cleric 4
Range: Touch
Duration: 10 minutes/level

This spell envelops a creature in a shroud of shadows. The shroud can conceal the creature's features. It also grants the recipient a +4 bonus to AC, darkvision to a range of 60 feet, and a +2 bonus to save vs. holy spells and light spells. Undead creatures in armor of darkness are turned as though they have 2 additional Hit Dice.

Astral Projection

Level: Cleric 9, Magic-User 9
Range: Touch
Duration: 2 hours

The caster projects his astral form into other places. The astral form is invisible to all but other astral creatures or travelers. If the caster's physical body is moved more than 100 miles from its original location while the astral form is away, the link is sundered and the caster's soul becomes lost in the beyond. If the caster's body is underground, it need only be moved 100 yards before the connection is broken.

The astral form is capable of casting spells, but there is a 5% chance per spell level that the spell fails to work. Additionally, there is a 2% chance per spell level of the attempted spell that the *astral projection* itself falters as a result of the spell casting, and the astral form returns to the physical body. When traveling in astral form upon the earth, the astral form may travel as fast as 100 miles per hour per level above 17th. If the form is traveling underground, its movement rate is 5'.

Atonement

Level: Cleric 5, Druid 5
Range: Touch
Duration: Instantaneous

This spell removes the burden of evil acts or misdeeds from a subject that has acted unwittingly. The creature seeking atonement must be truly repentant.

Audible Glamer

Level: Magic-User 1
Range: 30'
Duration: 3 minutes/level

You create a sound that rises, recedes, approaches, or remains at a fixed place. You choose what type of sound to create when you cast the spell and cannot change it afterwards. You can produce as much noise as four normal humans per caster level.

Augury

Level: Cleric 2
Range: Personal
Duration: Instantaneous

This spell tells you whether a particular action made in the next hour brings good or bad results for you in the immediate future. The base chance for receiving a meaningful reply is 70% + 1% per caster level; this roll is made secretly by the TK. Vague questions may offer no chance of success. If the roll succeeds, you get one of four results: Weal (the action will probably bring good results), Woe (the actions will probably bring bad results), Weal and Woe or Nothing for actions that don't have especially good or bad results or if the roll fails.

Focus: Marked sticks, bones or cards (100 gp)

Awaken

Level: Druid 5
Range: Touch
Duration: Instantaneous

You awaken a tree or animal to humanlike sentience. An awakened tree has characteristics as if it were an animated object (see Monsters) with human sentience. The spell has a 35% chance of success + 1% per druid level, minus 1% per Hit Dice of animal to be awakened or the Hit Dice the tree will have when it is awakened.

The awakened animal or tree is friendly toward you and serves you in specific tasks if you communicate to it your

desires. An awakened animal gains 2 HD and it is counted as a monster. An awakened tree or animal can speak one language that you know.

Balance

Level: Druid 6
Range: 30'
Duration: 1 minute

This spell creates balance between two designated opponents, giving each of them the average of their combined Hit Dice/levels. For example, a fight between a 4th level fighter and a 10th level cleric would result in both combatants fighting as though they were 7th level in their respective classes.

The combatants temporarily gain or lose abilities as their new levels dictate, but they do not gain or lose hit points. Spell casters who are temporarily reduced in level may lose access to their higher level spells, but the preparation of the spells is not negated; when the spellcaster's level returns to normal, the spells will be waiting for him. Spellcasters who gain access to higher level spells will not, however, suddenly have those spells prepared, and thus cannot cast them.

Banishment

Level: Cleric 6, Magic-User 7
Range: 30'
Duration: Instantaneous

Banishment enables you to force up to 2 HD of extra-planar creatures per level from your home plane. You can increase the spell's power by presenting an object or substance that the target hates, fears, or opposes. For each such object or substance, you reduce the target's magic resistance by 5% and impose a -2 penalty on its save.

Barkskin

Level: Druid 2
Range: Touch
Duration: 1 hour

Barkskin grants a +2 bonus to the target's Armor Class.

Bedlam

Level: Magic-User 5
Range: 30'
Duration: 1 minute

As *confusion*, except all creatures within 30 feet of the caster are affected. Only non-magical creatures (i.e.

creatures that cannot cast spells or use spell-like abilities) are permitted a saving throw against the spell.

Bestow Curse

Level: Magic-User 4
Range: Touch
Duration: Permanent

You place a curse on the subject by touching them. The curse can impose up to a -2 penalty on all rolls, or be something more creative invented by the player. The curse cannot be dispelled, but it can be removed with *break enchantment* or *remove curse*.

Binding

Level: Magic-User 8
Range: 30'
Duration: 1 year per level

You magically bind the target if its Hit Dice are no more than half your caster level. You can be assisted by others; for each assistant who casts *suggestion* while you cast this spell, your effective level is increased by 1. For each assistant who casts *dominate* while you cast this spell your effective level is increased by 3. The binding can take many forms, from eldritch chains to a mystic slumber, being imprisoned within a bottle or gem, or even being bound within a living tree, as the Lady of the Lake did to Merlin. The spell cannot be dispelled, but it is affected by *antimagic field* and *mage's disjunction*. Bound creatures are not subject to *dismissal*, *banishment* and similar effects.

Component: Opals worth 500 gp per Hit Dice of target.

Black Tentacles

Level: Magic-User 4
Range: 120'
Duration: 1 minute

This spell conjures a field of rubbery, 10' long black tentacles that erupt from whatever surface is underfoot, including water. Every creature within a 20-ft radius of the target spot of the spell is subject to a grapple attack with an attack bonus equal to your caster level. The tentacles inflict 2d6 points of damage per round and are immune to all types of damage. Creatures not grabbed by a tentacle can only move through the area at half speed.



Blade Barrier

Level: Cleric 6
Range: 60'
Duration: 2 hours

The cleric is surrounded by a circle of cherubs wielding slashing, thrusting blades in a 15' radius. The blades inflict 7d10 points of damage to anyone pass through them.

Bless/Bane

Level: Cleric 1
Range: 50' radius burst centered on caster
Duration: 1 hour

This spell gives each of your allies a +1 bonus on attack rolls and saving throws against fear effects.

If this spell is cast on water, it turns up to 1 pint into holy water. This use requires 5 lb. of silver dust.

Bane fills your enemies with fear and doubt. Each enemy takes a -1 penalty on attack rolls and saving throws against fear. If *bane* is cast on water, it turns up to 1 pint into unholy water. This use requires 5 lb. of silver dust.

Bless Weapon

Level: Cleric 1
Range: Touch
Duration: 1 hour

This spell makes a weapon capable of damaging Chaotic foes that are only harmed by silver or +1 weapons.

Blight

Level: Druid 4, Magic-User 5
Range: Touch
Duration: Instantaneous

This spell withers a single plant you touch. A targeted plant creature takes 1d6 points of damage per level.

Blindness/Deafness

Level: Cleric 3, Magic-User 2
Range: 120'
Duration: Permanent

You render the subject blind or deaf.

Blink

Level: Magic-User 3
Range: Personal
Duration: 1 round/level

You blink back and forth between the Material and Ethereal Planes. Physical attacks against you are -4 to hit and spells cast at you have a 50% chance of failing. If the attack is capable of striking ethereal creatures or the attacker can see invisible creatures, the chance of failure is only 20% and the penalty is only -2. An attacker that can do both things has no miss chance. Your own attacks are -2 to hit and your spells have a 20% chance of failure. While blinking, you can step through but not see through objects up to 1 foot thick.

Blur

Level: Magic-User 2
Range: Touch
Duration: 1 minute/level

The subject's outline appears blurred, shifting and wavering. This distortion forces opponents to re-roll all successful attacks against them. Opponents that cannot see the subject ignore the spell's effect.

Body Adjustment

Level: Magic-User 3
Range: Personal
Duration: Instantaneous

You heal yourself of 1d12 points of damage.

Bolt of Glory

Level: Cleric 6 (Lawful only)
Range: 30'
Duration: Instantaneous

You throw a bolt of positive energy at one creature. This requires a ranged attack. Undead creatures, Chaotic outsiders and negative energy creatures suffer 1d6 damage per level. Creatures from the Material Plane, the elemental planes and Neutral outsiders suffer 1d4 damage per level. Lawful outsiders and positive energy creatures suffer no damage.

Bolts of Bedevilment

Level: Cleric 5

Range: 120'

Duration: 1d4 rounds

You make one ray attack per round. The ray dazes one living creature for 1d4 rounds.

Brain Lock

Level: Magic-User 2

Range: 120'

Duration: Concentration + 1 round

The target is dazed and cannot cast spells for the duration of the spell.

Break Enchantment

Level: Cleric 5, Magic-User 5

Range: 30'

Duration: Instantaneous

This spell frees victims from enchantments, transmutations and curses, even instantaneous effects. The chance of breaking an enchantment is the same as for dispelling magic. If the effect comes from a magic item, *break enchantment* does not remove the curse from the item, but it does free the victim from the item's effects.

Burning Hands

Level: Magic-User 1

Duration: Instantaneous

A 15' cone of searing flame shoots from your fingertips and deals 1d4 points of fire damage per caster level.

Call Lightning

Level: Druid 3

Range: 120'

Duration: 1 minute/level

Each round you may call down a bolt of lightning that deals 3d6 points of damage, or if you are outdoors and in a stormy area 3d10 points of damage. This spell does not function underwater.

Call Lightning Storm

Level: Druid 5

Range: 240'

As *call lightning* except that each bolt deals 5d6 or 5d10 points of damage.

Calm Animals

Level: Druid 1

Range: 30'

Duration: 1 hour

This spell soothes and quiets up to 2d6 HD worth of ordinary animals, rendering them docile and harmless. Giant animals and guard animals are allowed a saving throw, while other animals are not.

Calm Emotions

Level: Cleric 2

Range: 120'

Duration: Concentration, up to 10 minutes

This spell calms all agitated or excited creatures within a 20' radius area, but does not control them. Creatures affected cannot take violent actions, although they can defend themselves. Any aggressive action against a calmed creature breaks the spell on all calmed creatures.

Cause Fear

Level: Cleric 1, Magic-User 1

Range: 30'

Duration: 1d4 rounds

The affected creature is frightened. Creatures with 6 or more Hit Dice or levels are immune.

Chain Lightning

Level: Magic-User 6

Range: 240'

Duration: Instantaneous

As *lightning bolt*, except *chain lightning* strikes one object or creature initially and then arcs to other targets. The bolt deals 1d6 points of damage per caster level to the primary target. After it strikes, lightning can arc to a number of secondary targets equal to your caster level. The secondary bolts each strike one target and deal half as much damage as the first. Each target can attempt a saving throw for half damage, no target can be more than 30 feet away from the primary target, and no target can be struck more than once.

Change Self

Level: Magic-User 1

Range: Personal

Duration: 1 hour

You don a simple magical disguise to look like somebody else. A creature interacting with you can tell it is a fake.

Changestaff

Level: Druid 7

Range: Touch

Duration: 1 hour/level

When you plant the end of a staff in the ground and cast this spell, the staff turns into a creature that looks and fights like a treant, although it cannot converse with actual treants or control trees. The creature defends you and obeys you. If it is reduced to 0 hit points, it crumbles into sawdust and the staff is destroyed. Otherwise, the staff returns to normal when the spell expires.

Focus: Limb from ash, oak or yew that is carved and polished; the process requires 28 days.

Chant

Level: Cleric 2

Duration: Concentration (up to 10 minutes)

As long as you chant, you and your allies gain a +1 bonus on attack rolls, damage rolls and saving throws while your foes take a -1 penalty on the same. Any interruption in your chanting ends this spell.

Chariot of Fire

Level: Druid 8

Range: 10'

Duration: 1 hour

You summon a flaming chariot pulled by two fiery steeds. The chariot moves at a speed of 80' per round on land and 40' per round in the air. It can accommodate the druid and six passengers, who are unharmed by its fire. Others suffer 3d6 points of fire damage if touched by the chariot or 1d6 points of fire damage if within 5' of it. The chariot has AC 18 and 60 hit points. It can be damaged by +1 or better weapons, cold damage, and water, which deals 1d6 points of damage per gallon of water.

Charisma

Level: Cleric 2, Druid 2, Magic-User 2

Range: Touch

Duration: 1 hour

This spell grants the subject 18 charisma. This cannot be made permanent.

Charm Animal

Level: Druid 1

As *charm person* except that it only affects animals.

Charm Monster

Level: Magic-User 4

Duration: See below

As *charm person* except that the effect is not restricted to humanoids. Monsters can make one saving throw per week to break free.

Charm Person

Level: Druid 2, Magic-User 1

Range: 30'

Duration: Until dispelled

You make a humanoid creature regard you as its trusted friend and ally. You cannot control the person, but you can influence them as though you were a friend. Any hostile act or suggestion breaks the spell.

Chill Touch

Level: Magic-User 1

Range: Touch

Duration: Instantaneous

Your touch channels negative energy that deals 1d6 points of hit point damage and 1 point of Strength damage. You can use this melee attack up to one time per level. An undead creature takes no damage, but must make a successful saving throw or become frightened.

Choke

Level: Magic-User 4

Range: 30'

Duration: Concentration, up to 1 minute

You cause the target of this spell to choke. The victim must make saving throw to hold his breath. The save must be repeated each round with the difficulty increasing by 1 per round. When the character fails one of these saves, he begins to choke. A choking victim is stunned and suffers 1d4 points of damage per round.

Choir

Level: Cleric 1

Duration: See below

Choir allows up to five clerics to join their powers together. The clerics must stand with the highest level cleric in the front and the others behind them, all within five feet. While so assembled, the leader's effective cleric level is increased by +1 for each additional cleric in the *choir*, to a maximum of +4. This higher effective level applies to turn undead checks and spell variables. While assembled in a *choir*, the clerics' enemies get a tactical advantage against them in combat.

Circle of Death

Level: Magic-User 6
Area of Effect: 150' radius
Duration: Instantaneous

This spell slays 1d4 HD worth of living creatures per caster level in a burst centered on the spell caster. Creatures with the fewest HD are affected first. Creatures with 9 or more Hit Dice are not affected.

Circle of Doom

Level: Cleric 5
Area of Effect: 20' radius
Duration: Instantaneous

Negative energy bursts in all directions from the point of origin, dealing 1d8 points of damage +1 point per caster level to nearby living enemies. Like *inflict* spells, *circle of doom* heals undead rather than harming them.

Clairsentience

Level: Magic-User 3
Range: 60'
Duration: 2 hours

You can see and hear through solid stone (limiting range to 2') and other obstacles within a range of 60'. The spell's effect cannot pass through even a thin sheeting of lead. The spell can be cast through a *crystal ball*.

Clenched Fist

Level: Magic-User 8
Range: 120'
Duration: 1 minute

As *interposing hand*, except that the hand can interpose itself, push, or strike one opponent that you select. The floating hand can move as far as 60' and can attack in the same round. The hand attacks once per round, and its attack bonus equal to your caster level. The hand deals 2d8 points of damage on each attack, and any creature struck must pass a saving throw or be stunned for 1

round. The clenched fist can interpose itself as an *interposing hand* or can bull rush as a *forceful hand*.

Clone

Level: Magic-User 8
Duration: Instantaneous

A piece of flesh taken from a living person is grown into an exact duplicate of the person at the time the flesh was removed. This takes 2d4 months. The clone is alive but inert. If the original is slain, their soul occupies and animates the clone. The clone has the same personality, memories and abilities as the original did at the time the flesh was taken.

Focus: A vat and 1,000 gp in laboratory supplies

Cloudkill

Level: Magic-User 5
Range: 120'
Duration: 1 hour

Foul and poisonous vapors boil from the thin air, forming a cloud 15' in radius. The cloud moves directly forward at a speed of 40 feet per round unless its direction or speed is affected by winds. Unusually strong gusts of wind can dissipate and destroy it. Poison-laden, the horrid mist is heavier than air, and thus sinks down any pits or stairs in its path. Even touching the cloud (much less breathing it) requires a saving throw to avoid immediate death.

Color Spray

Level: Magic-User 1
Area: 15' cone
Duration: Instantaneous; see text

A cone of vivid, clashing colors springs from your hand. Each creature within the cone is affected according to its Hit Dice. Creatures with 2 HD or less are knocked unconscious for 2d4 rounds. Creatures with 3 or 4 HD are blinded for 1d4 rounds. Creatures with 5 or more HD are stunned for 1 round. Sightless creatures are not affected by color spray.

Command I

Level: Cleric 1
Range: 30'
Duration: 1 round

You give the subject a single, one-word command, which it obeys to the best of its ability and at its earliest

opportunity. If you command a creature to “die”, they play dead for 1 round.

Command II

Level: Cleric 5

Duration: 10 rounds

This spell functions like *command I*, except that up to one creature per level is affected and the activities continue beyond 1 round. At the start of each commanded creature’s action after the first, it gets another save to attempt to break free from the spell. Each creature must receive the same command.

Command Plants

Level: Druid 4

Range: 30’

Duration: One day/level

As *charm person*, except it only affects plant creatures.

Command Undead

Level: Magic-User 2

Range: 30’

Duration: One day/level

As *charm person*, except that it only affects undead.

Commune

Level: Cleric 5

Range: Personal

Duration: 3 questions

Higher powers grant an answer to three questions the caster poses to them. Higher powers do not like being interrogated by mere mortals, so the spell should be limited to once per week or so by the Treasure Keeper. The answers given are correct within the limits of the entity’s knowledge.

Component: Holy or unholy water and incense

Commune with Nature

Level: Druid 5

Range: Personal

Duration: Instantaneous

You instantly gain knowledge of as many as three facts from among the following subjects: The ground or terrain, plants, minerals, bodies of water, people, general animal population, presence of woodland creatures, presence of powerful unnatural creatures, or even the general state of the natural setting. In outdoor settings,

the spell operates in a radius of 1 mile per caster level. In natural underground settings—caves, caverns, and the like—the radius is limited to 100’ per caster level. The spell does not function where nature has been replaced by construction, such as in dungeons and towns.

Comprehend Languages

Level: Cleric 1, Magic-User 1

Range: Personal

Duration: 1 hour

You can understand the spoken words of creatures or read otherwise incomprehensible written messages. In either case, you must touch the creature or the writing. Magical writing cannot be read, though the spell reveals that it is magical. This spell can be foiled by the *secret page* and *illusory script* spells. It does not decipher codes or reveal messages concealed in text.

Cone of Cold

Level: Magic-User 5

Area: 60’ cone

Duration: Instantaneous

All creatures within the *cone of cold* suffer 1d6 points of cold damage per caster level.

Cone of Paralysis

Level: Magic-User 6

Area: 60’ cone

Duration: 1 minute

All creatures within the cone are paralyzed for 1 minute.



Confusion

Level: Magic-User 4, Druid 7
 Range: 120'
 Duration: 2 hours

This spell forces 2d6 creatures to act randomly. On a roll of 2d6, the creatures do the following:

2d6	Behavior
2-5	Attack caster and his allies
6-8	Stand baffled and inactive
9-12	Attack each other

The effects are re-rolled each round. A confused character that cannot carry out the action just babbles incoherently. A confused character that is attacked fights back.

Consecrate/Desecrate

Level: Cleric/Anti-Cleric 2
 Range: 30'
 Duration: 24 hours

This spell blesses a 20' radius area with positive energy. Each "turn undead" made within this area gains a +2 bonus to the roll. Every undead creature entering a consecrated area suffers a -1 penalty on attack rolls, damage rolls, and saving throws. Undead cannot be created within or summoned into a consecrated area. If the consecrated area contains an altar, shrine, or other permanent fixture dedicated to a higher power, the modifiers are doubled. You cannot consecrate an area with a similar fixture of a deity other than your own patron. If the area does contain an altar, shrine, or other permanent fixture of an alignment other than yours, the *consecrate* spell instead curses the area, cutting off its connection with the associated alignment. This secondary function does not also grant the bonuses and penalties given above.

This reverse, *desecrate*, has the opposite effect of the *consecrate* spell.

Component: Holy or unholy water and 5 lb. of silver dust

Constitution

Level: Cleric 2, Druid 2, Magic-User 2
 Range: Touch
 Duration: 1 hour

The spell grants the subject 18 constitution. It cannot be made permanent.

Contact Other Plane

Level: Magic-User 5
 Range: Personal
 Duration: Concentration

The caster creates a mental contact with higher intelligences in order to gain answers to the questions he contemplates. The spell's effects depend upon how deeply into the caster quests into the various planes of existence. The caster must decide how "far" into the planes he wishes to make contact. The number of planes deep that he chooses affects the number of yes or no questions he can ask, the chance that the knowledge is available at that level, the chance of receiving an incorrect answer, and the chance that he goes mad from the experience. Madness lasts for as many weeks as the "number" of the plane where the caster's sanity failed.

Plane of Existence	Max # Questions	Available Knowledge	Wrong Result	Chance of Madness
3rd	3	25%	70%	1%
4th	4	30%	60%	10%
5th	5	40%	50%	20%
6th	6	50%	40%	30%
7th	7	60%	30%	40%
8th	8	70%	25%	45%
9th	9	80%	20%	55%
10th	10	85%	15%	65%
11th	11	90%	10%	75%
12th	12	95%	1%	85%

Contingency

Level: Magic-User 6
 Range: Personal
 Duration: One month

After casting this spell, you can cast another spell upon your person so that it comes into effect under some condition that you dictate. The spell to be brought into effect by *contingency* must be one that affects your person and be of a spell level no higher than one-third your caster level (maximum 6th level). You can use only one *contingency* spell at a time.

Component: Vial of quicksilver, eyelash from an ogre mage or rakshasa

Focus: Ivory statuette of you and 1,500 gp worth of gems

Continual Light

Level: Cleric 3, Magic-User 2

Range: Touch

Duration: Permanent

A light equivalent to a torch springs forth from an object that you touch. A *continual light* can be covered and hidden but not smothered or quenched.

Component: 50 gp of ruby dust sprinkled on the object to carry the light

Control Plants

Level: Druid 8

Range: 30'

Duration: 10 minutes

This spell enables you to control the actions of 2 Hit Dice of plant creatures per caster level. At the end of the spell, the subjects revert to their normal behavior. They ignore self-destructive commands.

Control Undead

Level: Magic-User 7

Range: 30'

Duration: 10 minutes

This spell enables you to command 2 HD of undead creatures per caster level. At the end of the spell, the subjects revert to their normal behavior. Intelligent undead creatures remember that you controlled them.

Control Water

Level: Cleric 4, Druid 4, Magic-User 6

Range: 240'

Duration: 1 hour

This spell allows you to lower or raise water.

Lowering water causes water or a similar liquid to reduce its depth by as much as 2 feet per caster level to a minimum depth of 1 inch. The water is lowered within a square depression whose sides are up to caster level x 10 feet long. In extremely large and deep bodies of water, such as a deep ocean, the spell creates a whirlpool that sweeps ships and similar craft downward, putting them at risk and rendering them unable to leave by normal movement for the duration of the spell. When cast on water-based creatures, this spell acts as *slow*.

Raising water causes water or a similar liquid to rise in height, just as the lower water version causes it to lower. Boats that are raised in this manner slide down the sides

of the water hump created by the spell. If the area affected by the spell includes riverbanks, a beach, or other land nearby, the water can spill over onto dry land.

Control Weather

Level: Cleric 7, Druid 7, Magic-User 7

Range: 2 mile radius centered on caster

Duration: Treasure Keeper's discretion

The caster can summon or stop rainfall, create unusually high or low temperatures, summon or disperse tornados, clear the sky of clouds, or summon clouds.

Control Winds

Level: Druid 5

Range: 40' per level

Duration: Treasure Keeper's discretion

As *control weather*, but this spell only affects wind speed and direction.

Create Food and Water

Level: Cleric 3

Range: 30'

Duration: Instantaneous

This spell creates a one-day supply of food and drinking water for 24 men (or, for game purposes, horses). At 9th level, the amount of food and water doubles, and doubles again at every level thereafter.

Create Undead

Level: Anti-Cleric 6, Magic-User 6

Range: 30'

Duration: Instantaneous

This evil spell, which must be cast at night, allows you to create more powerful undead based on your caster level (see below). You may create less powerful undead than your level would allow if you choose. Created undead are not automatically under the control of their animator.

Focus: Clay pot filled with grave dirt and another filled with brackish water. The spell must be cast on a dead body. You must place a black onyx gem worth at least 50 gp per HD of the undead to be created into the mouth or eye socket of each corpse. The magic of the spell turns these gems into worthless stones.

Caster Level	Can Create ...
11th or lower	Ghouls
12th–14th	Ghasts
15th–17th	Shadows or wraiths
18th–19th	Mummies or spectres
20th or higher	Devourers or mohrgs

Create Water

Level: Cleric 1, Druid 1

Range: 30'

Duration: Instantaneous

This spell generates 2 gallons per level of wholesome, drinkable water, just like clean rain water. Water weighs 8 lb per gallon.

Creation I

Level: Magic-User 4

Range: 0'

Duration: 6 hours

You create a non-magical object of non-living, vegetable matter. The weight cannot exceed 10 pounds/level. It cannot be used as a material component or spell focus.

Creation II

Level: Magic-User 5

Range: 30'

Duration: 6 hours

As *creation I*, except that you can create mineral objects and objects weighing up to 30 pounds/level.

Creeping Doom

Level: Druid 7

Range: 30'

Duration: 10 minutes

This spell summons 2d6 centipede swarms that are under your command.

Crown of Glory

Level: Cleric 8

Range: Personal

Duration: 10 minutes

The caster inspires awe within a radius of 120' by donning a crown. All creatures with fewer than 8 HD or levels cease what they are doing and are compelled to pay attention to the caster. When the caster speaks all listeners telepathically understand her, even if they do not share a language. While the spell lasts, the caster can

make up to three suggestions to creatures in range as if she were using the *suggestion* spell.

Any such creature that wants to take hostile action against the caster must engage in a contest of wills against them. In a contest of wills, both combatants roll 1d20. The spellcaster adds his Wisdom score to the roll. The attacker adds his Charisma score to the roll. The higher roll wins the contest.

Any creature in the spell's area of effect that fails a contest of wills or does not attempt one is enthralled for the duration of the spell (as the *enthrall* spell).

Focus: Crown worth at least 200 gp

Crushing Despair

Level: Magic-User 4

Area: 30' cone

Duration: 2d6 minutes

An invisible cone of despair causes great sadness in the subjects. Each affected creature takes a -2 penalty on attack rolls, saving throws and damage rolls.

Crushing Hand

Level: Magic-User 9

Range: 120'

Duration: 1 minute

As *interposing hand*, except that the hand can interpose itself, push, or crush one opponent that you select. The *crushing hand* can grapple an opponent like *grasping hand* does. Its attack bonus equals your caster level. The hand deals 2d8 points of damage on each successful grapple attack against an opponent. The *crushing hand* can also interpose itself as *interposing hand*, or bull rush a foe as *forceful hand*.

Crystal-Steel

Level: Magic-User 8

Range: Touch

Duration: Permanent

You give up to 10 pounds of glass or crystal per level the strength and hardness of steel.

Crystallize

Level: Magic-User 6

Range: 120'

Duration: Permanent

In the blink of an eye, the subject's form seems to freeze over, as its flesh and fluids are instantly crystallized. The subject appears lifeless, and though it is not dead, no life can be detected with spells that detect such. When the spell is dispelled, crystal turns back into flesh, and the subject is in exactly the state he was prior being affected by crystallize.

Cure Blindness/Deafness

Level: Cleric 3

Range: Touch

Duration: Instantaneous

This spell cures blindness or deafness. The spell does not restore ears or eyes that have been lost, but it repairs them if they are damaged.

Cure/Cause Disease

Level: Cleric 3, Druid 3, Magic-User 4*

Range: Touch

Duration: Instantaneous

This spell cures all diseases and kills all parasites (including green slime) in a subject. Certain magical diseases might not be countered by this spell or might only be countered by a caster of a certain level or higher.

The reverse, *cause disease*, infects the target with a disease (see Rules of Play). The effects of the disease begin immediately, without an incubation period.

*Magic-users can only cast *cause disease*.

Cure/Inflict Critical Wounds

Level: Cleric 4, Druid 5

Range: Touch

Duration: Instantaneous

This spell cures 4d6+4 points of damage, or deals 4d6+4 points of damage to the undead.

The reverse, *inflict critical wounds*, does the opposite.

Cure/Inflict Light Wounds

Level: Cleric 1, Druid 2

Range: Touch

Duration: Instantaneous

This spell cures 1d6+1 points of damage, or deals 1d6+1 points of damage to the undead.

The reverse, *inflict light wounds*, does the opposite.



Cure/Inflict Moderate Wounds

Level: Cleric 2, Druid 3

Range: Touch

Duration: Instantaneous

This spell cures 2d6+2 points of damage, or deals 2d6+2 points of damage to the undead.

The reverse, *inflict moderate wounds*, does the opposite.

Cure/Inflict Serious Wounds

Level: Cleric 3, Druid 4

Range: Touch

Duration: Instantaneous

This spell cures 3d6+3 points of damage, or deals 3d6+3 points of damage to the undead.

The reverse, *inflict serious wounds*, does the opposite.

Curse of the Mummy

Level: Anti-Cleric 6

Range: Touch

Duration: Instantaneous

You infect the target of this spell with mummy rot (see Mummy description in *Treasure Keeper's Tome*).

Dancing Lights

Level: Magic-User 1

Range: 120'

Duration: 1 minute

You create up to four lights that resemble lanterns or torches, or up to four glowing spheres of light which look like will-o'-wisps, or one faintly glowing humanoid shape. The dancing lights must stay within a 10'-radius area in relation to each other but otherwise move as you desire: Forward or back, up or down, straight or turning corners, or the like. The lights can move up to 100' per round. If the distance between you and a light exceeds the spell's range, it winks out.

Darkness

Level: Cleric 2, Magic-User 2

Range: Touch

Duration: 1 hour

This spell causes complete darkness in a 15-foot radius. Creatures with darkvision cannot pierce this magical darkness. It is cancelled with *light* or *continual light*.

Darkness II

Level: Cleric 3

Duration: 1 day

Duration: 1 hour

As *darkness*, except it affects a 60' radius area.

Darkvision

Level: Magic-User 2

Range: Touch

Duration: 1 day

The subject gains darkvision to a range of 60'. *Darkvision* does not grant one the ability to see in magical darkness.

Dart of Mistletoe

Level: Druid 6

Range: Touch

Duration: 1 minute or until discharged

This spell turns a piece of mistletoe into a lethal weapon. The druid must throw the dart as a ranged attack. If it hits, the victim must make a saving throw or die instantly. However, the victim is only mostly dead – the next time the sun rises, the victim lives again.

Focus: Piece of mistletoe dipped in 10 gp of gold

Daylight

Level: Cleric 3, Druid 3, Magic-User 3

Range: Touch

Duration: 1 hour

An object touched by the caster sheds light as bright as daylight in a 90' radius. This spell is not the equivalent of sunlight for the purposes of creatures that are damaged or destroyed by sunlight.

Daze

Level: Magic-User 1

Range: 30'

Duration: 1 round

This spell clouds the mind of a humanoid creature with 4 or fewer Hit Dice so that it may take no action.

Daze Monster

Level: Magic-User 2

Range: 120'

Duration: 1 round

This spell functions like *daze*, but can affect any one living creature of any type with 6 or fewer Hit Dice.

Death Fog

Level: Magic-User 6

Range: 120'

Duration: 1 minute

Death fog creates a billowing mass of misty vapor 20' in radius and 20' high, similar to the *solid fog* spell. In addition to slowing creatures down and obscuring sight, the vapors deal 2d6 points of acid damage each round.

Death Knell

Level: Cleric 2

Range: Touch

Duration: 1 hour

You draw forth the ebbing life force of a creature and use it to fuel your own power. Upon casting this spell, you touch a living creature that has only 1 remaining hit point. If the subject fails a saving throw, it dies, and you gain 1d6 hit points that last for 1 hour.

Deathwatch

Level: Cleric 1

Range: 30'

Duration: 1 hour

You can determine the condition of creatures near death within the spell's range. You instantly know whether each creature is dead, mostly dead (3 or fewer hit points left), not dead yet (4 or more hit points), undead or

neither alive nor dead. *Deathwatch* sees through any spell or ability that allows creatures to feign death.

Delay Poison

Level: Cleric 2, Druid 2

Range: Touch

Duration: 1 hour

The subject becomes temporarily immune to poison. Any poison in its system or any poison to which it is exposed during the duration does not affect the subject until the spell's duration has expired. *Delay poison* does not cure any damage that poison has already done.

Delayed Blast Fireball

Level: Magic-User 7

Range: 240'

Duration: See description

This spell creates a *fireball* (q.v.) whose blast can be delayed for up to 10 minutes.

Demand

Level: Magic-User 8

Range: See text

Duration: 1 round; see text

As *sending*, but the message can also contain a suggestion (as the spell), which the subject does its best to carry out. If the demand is received, it is understood even if the subject's intelligence score is as low as 1 (i.e. animal intelligence). The message must be short and to the point. The creature can give a short reply immediately.

Density Control

Level: Magic-User 6

Range: Personal

Duration: 3 minutes

This spell alters the magic-user's density. At minimum density he is immune to physical weapons. At maximum density, he is AC 18 and his fists deal 1d6 damage. Items in the magic-user's possession change with him, and remain changed as long as they remain in his possession.

Destruction

Level: Cleric 7

Range: 30'

Duration: Instantaneous

This spell instantly slays the subject and consumes its remains utterly. If the target's saving throw succeeds, it

instead takes 10d6 points of damage. The only way to restore life to a character which has been destroyed by this spell is to use *true resurrection*, *wish* or *miracle*.

Focus: Silver holy or unholy symbol inscribed with verses of anathema, costs 500 gp

Detect Animals or Plants

Level: Druid 1

Range: 240'

Duration: 1 hour

You can detect a particular kind of animal or plant within the spell's range. You must think of the kind of animal or plant when using the spell, but you can change the kind of animal or plant each round.

Detect Evil/Good

Level: Cleric 1, Magic-User 2

Range: 60'

Duration: 2 turns

The caster detects any evil enchantments, intentions, thoughts or auras within the spell's range. Poison is not inherently evil, and cannot be detected by this spell.

The reverse, *detect good*, detects good enchantments, intentions, thoughts or auras within the spell's range. Candy is not inherently good, and cannot be detected by means of this spell.

Detect Invisibility

Level: Magic-User 2

Range: Personal

Duration: 1 hour

You can see any objects or beings that are invisible within your range of vision, as well as any that are ethereal, as if they were normally visible.

Detect Lie

Level: Cleric 4

Range: 30'

Duration: 1 hour

You know if a person within range is deliberately and knowingly speaking a lie. The spell does not reveal the truth, uncover unintentional inaccuracies, or necessarily reveal evasions.

Detect Magic

Level: Cleric 1, Druid 1, Magic-User 1
Range: 60'
Duration: 20 minutes

The caster can perceive in places, people, or things the presence of a spell within the spell's range. Magical items may be discovered in this fashion, as can the presence of a charm secretly laid upon a person.

Detect Poison

Level: Cleric 1, Druid 1, Magic-User 1
Range: 30'
Duration: 1 hour

You determine whether a creature or object has been poisoned or is poisonous.

Detect Scrying

Level: Magic-User 4
Area: 40' radius centered on you
Duration: 24 hours

You immediately become aware of any attempt to observe you by means of a *scrying* spell. You know the location of every magical sensor within the spell's area. If the scrying attempt originates within the area, you also know its location. Otherwise, you and the scryer immediately make opposed checks (1d20 + caster level). If you at least match the scryer's result, you get a visual image of the scryer and a sense of their location.

Detect Secret Doors

Level: Magic-User 1
Range: 60'
Duration: 20 minutes

You can detect secret doors, compartments and caches.

Detect Snares and Pits

Level: Druid 1
Range: 60'
Duration: 20 minutes

You can detect simple pits, deadfalls, and snares as well as mechanical traps constructed of natural materials and some natural hazards—quicksand (a snare), a sinkhole (a pit), or unsafe walls of natural rock (a deadfall).

Detect Undead

Level: Cleric 1, Magic-User 1
Range: 60'
Duration: 20 minutes

You can detect the presence of the undead.

Dexterity

Level: Cleric 2, Druid 2, Magic-User 2
Range: Touch
Duration: 1 hour

The spell grants the subject 18 dexterity. This cannot be made permanent.

Dimension Door

Level: Magic-User 4
Range: 240'
Duration: 1 hour

The spell caster teleports a person or object anywhere within the spell's range with perfect accuracy.

Dimensional Anchor

Level: Cleric 4, Magic-User 4
Range: 120'
Duration: 1 hour

A green ray bolts from your outstretched hand. A creature or object struck by the ray is covered with a shimmering emerald field that blocks extra-dimensional travel. Forms of movement barred by a dimensional anchor include *astral projection*, *blink*, *dimension door*, *ethereal jaunt*, *etherealness*, *gate*, *maze*, *plane shift*, *shadow walk*, *teleport* and similar abilities.

Dimensional anchor does not interfere with the movement of creatures already in ethereal or astral form when the spell is cast, nor does it block extra-dimensional perception or attack forms. *Dimensional anchor* does not prevent summoned creatures from disappearing at the end of a summoning spell.

Dimensional Lock

Level: Cleric 8, Magic-User 8
Range: 120'
Duration: 2 weeks

You create a shimmering emerald green barrier 20' in radius that blocks extra-dimensional travel. Forms of movement barred include *astral projection*, *blink*, *dimension door*, *ethereal jaunt*, *etherealness*, *gate*, *maze*,

plane shift, shadow walk, teleport and similar abilities. Once a lock is in place, extra-dimensional travel into or out of the area is impossible.

Dimensional lock does not interfere with the movement of creatures already in ethereal or astral form when the spell is cast, nor does it block extra-dimensional perception or attack forms. It does not prevent summoned creatures from disappearing at the end of a summoning spell.

Diminish Plants

Level: Druid 3
Range: See text
Duration: Instantaneous

One version of this spell causes normal vegetation to shrink to about 1/3 of its normal size, becoming untangled and easier to move through. The area of effect is a 100-foot-radius circle.

The second version of this spell targets all normal plants within a range of 1/2 mile, reducing their potential productivity over the course of the following year to one third below normal.

Neither version has an effect on plant creatures.

Discern Aura

Level: Druid 1
Range: 30'
Duration: Concentration

You can see the aura that surrounds all living beings, and can read from it the following:

Round 1: A creature's total and remaining hp.

Round 2: The creature's total HD or levels.

Round 3: If the creature has class levels, to what class or classes they come from, and if there are magic-user spells currently cast on them.

Discern Location

Level: Cleric 8, Magic-User 8
Range: Unlimited
Duration: Instantaneous

Discern location discovers the location of a creature or object. Nothing short of a *mind blank* spell or the direct intervention of a deity keeps you from learning the exact location of a single individual or object. *Discern location* circumvents normal means of protection from scrying or

location. To find a creature with the spell, you must have seen the creature or have some item that once belonged to it. To find an object, you must have touched it.

Disintegrate

Level: Magic-User 6
Range: 60'
Duration: Instantaneous

The caster defines one specific target and it disintegrates. Magical materials are not disintegrated, but objects composed of force (like *wall of force*) are affected. Living creatures are permitted a saving throw.

Dismissal

Level: Cleric 4, Magic-User 5
Range: 30'
Duration: Instantaneous

This spell forces an extra-planar creature back to its proper plane. There is a 20% chance that the subject of the spell is sent to a plane other than its own.

Dispel Evil/Good

Level: Cleric/Anti-Cleric 5
Range: 30'
Duration: 10 minutes against an item

This spell is similar to *dispel magic*, but affects only Chaotic magic. Unlike *dispel magic* it protects you temporarily from evil "sendings," including dreams or supernatural hunting-beasts. The power of an evil magic item is held in abeyance for 10 minutes. Evil spells are completely destroyed.

As with *dispel magic*, the chance of successfully dispelling evil is a percentage based on the ratio of the level of the dispelling caster over the level of original caster (or HD of the monster). Thus, a 9th level cleric attempting to dispel an evil charm cast by an 18th level cleric has a 50% chance of success ($9/18 = 1/2$, or, 50%). If the 18th level cleric were dispelling the 9th level cleric's spell, the chance is $18/9 = 2$, thus 200%.

The reverse, *dispel good*, functions like *dispel evil*, except that it works against Lawful magic.

Dispel Magic

Level: Cleric 3, Druid 4, Magic-User 3
Range: 120'
Duration: Instantaneous

This spell dispels (ends or negates) spells currently in effect, except those on magic items and the like. The success is the ratio of the dispeller's level over the level or Hit Dice of the original caster. Thus, if a 6th level magic-user attempts to dispel a spell cast by a 12th level magic-user, she has a 50% chance of success (6 divided by 12 = 50%).

Dispel Wounds

Level: Magic-User 4
Range: Touch
Duration: 1 hour

The caster can touch up to four subjects when he casts this spell. The subjects regain 50% of the hit points they have lost that day and ignore any fatigue they may be suffering. When the duration ends, they return to their real hit point total.

Displacement

Level: Magic-User 3
Range: Touch
Duration: 1 minute

The subject of this spell appears to be about 2' away from its true location, giving them a +2 bonus to AC, and a +2 bonus to save vs. spell effects that must be aimed.

Disrupt Undead

Level: Magic-User 1
Range: 30'
Duration: Instantaneous

A shimmering ray deals 1d6 points of damage to an undead creature.

Disrupting Weapon

Level: Cleric 5
Range: Touch
Duration: 1 minute

This spell makes a melee weapon deadly to undead. Any undead creature with HD equal to or less than your caster level must succeed on a save or be destroyed utterly if struck in combat with this weapon. Magic resistance does not apply against the destruction effect.

Divination

Level: Cleric 4
Range: Personal
Duration: Instantaneous

Divination can provide you with a useful piece of advice in reply to a question concerning a specific goal, event, or activity that is to occur within one week. The base chance for a correct divination is 70% + 1% per caster level, to a maximum of 90%. If the dice roll fails, you know the spell failed unless specific magic yielding false information is at work.

Component: Incense and sacrifice worth at least 25 gp

Divine Favor

Level: Cleric 1
Range: Personal
Duration: 1 minute

You gain a +1 bonus on attack and weapon damage rolls. The bonus does not apply to spell damage.

Divine Power

Level: Cleric 4
Range: Personal
Duration: 1 minute

Your attack bonus equals your character level, you gain a +2 bonus to melee damage and you gain 1d6 temporary hit points.

Dominate Animal

Level: Druid 3
Range: 30'
Duration: 1 minute

You can enchant an animal and direct it with simple commands such as "attack," "run," and "fetch." Suicidal or self-destructive commands are ignored.

Dominate Monster

Level: Magic-User 9
Range: 30'
Duration: Until dispelled

As dominate person, except that the spell is not restricted by creature type. Monsters can make one save per week to break free.

Dominate Person

Level: Magic-User 5
Range: 30'
Duration: Until dispelled

With this spell you can control the actions of any humanoid creature through a telepathic link that you establish with the subject's mind. Once you have given a

dominated creature a command, it continues to attempt to carry out that command to the exclusion of all other activities except those necessary for day-to-day survival. Subjects resist this control with a saving throw, and any subject forced to take actions against its nature receives a new save with a +2 bonus. Self-destructive orders are not carried out. Once control is established, the range at which it can be exercised is unlimited as long as you and the subject are on the same plane.

Doom

Level: Cleric 1
Range: 120'
Duration: 1 minute

This spell fills a single subject with a feeling of existential dread that imposes a -1 penalty to attack and save.

Dream

Level: Magic-User 5
Range: Unlimited
Duration: See text

You or a messenger touched by you sends a message to others in the form of a dream. You enter a trance and appear in the intended recipient's dream to deliver the message. The communication is one-way. The recipient cannot ask questions or offer information, nor can the messenger gain any information by observing the dreams of the recipient. Once the message is delivered, the messenger's mind returns instantly to its body.

Earthquake

Level: Cleric 8, Druid 8
Range: 240'
Duration: 1 round

The spell caster causes a powerful earthquake in a 60' radius around a point she chooses within 500'. The quake topples walls, causes rock-slides, and opens gaping fissures in the earth. Any creature caught in the quake has a 1 in 6 chance of falling into the depths of the earth and killed. The earthquake's tremors do not extend in any way beyond the spell's area of effect.

Earthwalk

Level: Magic-User 7
Range: Personal
Duration: 1 day

When you cast this spell, you can pass through stone, dirt or almost any other sort of earth except metal as easily

as a fish swims through water. You can breathe normally while passing through earth, and your passage does not leave behind any tunnel or hole, nor does it create any ripple or other sign of your presence. However, a *move earth* spell cast on the area where you are burrowing flings you back 30', stunning you for one round unless you succeed on a save.

Ego Whip

Level: Magic-User 2
Range: 120'
Duration: Instantaneous

Your rapid mental lashings assault the ego of your enemy, debilitating its confidence. The target takes 1d4 points of charisma damage or half that amount (minimum 1 point) on a successful save. A target that fails its save is stunned for 1 round.

Elemental Swarm

Level: Druid 9
Range: 120'
Duration: 1 hour

This spell opens a portal to the Elemental Plane of the druid's choice and summons 2d4 medium elementals from it. Ten minutes later, 1d4 large elementals appear. Ten minutes after that, one huge elemental appears. Each elemental has maximum hit points per HD. Once these creatures appear, they serve you for 1 hour.

Elemental Weapon

Level: Druid 1, Magic-User 1
Range: Touch
Duration: 1 minute

For the duration of the spell, one weapon deals an additional 1d6 points of acid, cold, electricity or fire damage, chosen when the spell is cast.

Endure Elements

Level: Cleric 1, Druid 1, Magic-User 1
Range: Touch
Duration: 24 hours

A creature protected by *endure elements* suffers no harm from being in a hot or cold environment. It can exist comfortably in conditions between -50 and 140 degrees Fahrenheit without having to make saves. The creature's equipment is likewise protected.



Energy Drain

Level: Magic-User 9
Range: 30'
Duration: Instantaneous

As *enervation*, except that the creature struck loses 2d4 levels. There is no saving throw to avoid losing the levels, but 24 hours after losing them, the subject must make a saving throw for each level lost. If the save succeeds, that level is regained. If it fails, the level loss is permanent.

Energy Missile

Level: Magic-User 1
Range: 120'
Duration: Instantaneous

A bolt of energy blasts from your fingertips. With a successful ranged attack, you deal 1d6+1 points of energy damage (acid, cold, electricity, fire, or sonic) to the target. For every two caster levels beyond 1st, you gain an additional missile: Two at 3rd level, three at 5th, four at 7th, and five bolts at 9th level or higher.

Enervation

Level: Magic-User 4
Range: 30'
Duration: Instantaneous

You point your finger and release a ray of crackling black energy that suppresses the life force of any living creature it strikes. If the subject fails a saving throw, it is

hit by the ray and loses 1d4 levels. Assuming the subject has at least 1 level left, it regains those lost levels after a number of hours equal to your caster level.

Enlarge Person

Level: Magic-User 1
Range: 30'
Duration: 1 minute

This spell causes a humanoid creature to double in size. The target gains a +2 bonus to Str and a -2 penalty to Dex (to a minimum of 1). Sufficient room must be available for the desired growth. All equipment worn or carried by a creature is also enlarged by the spell.

Entangle

Level: Druid 1
Range: 240'
Area: 40' radius spread within range
Duration: 1 minute

Normal plants wrap around creatures in the area or those that enter the area, entangling them. The creature can break free and move half its normal speed by rolling 1d20 under their Strength score.

Enthral

Level: Cleric 2
Range: 120'
Duration: 1 hour or less

If you have the attention of a group of creatures, you can use this spell to hold them spellbound. To cast the spell, you must speak or sing without interruption for a full round. Thereafter, those affected give you their undivided attention, ignoring their surroundings. They are considered to be friendly while enthralled. Any potentially affected creature of a species or alignment unfriendly to yours gets a +4 bonus on their saving throw. The effect lasts as long as you speak or sing, to a maximum of one hour. Those enthralled by your words take no action while you speak or sing and for a minute thereafter while they discuss the topic or performance. If any member of the audience is attacked, the spell ends and the formerly enthralled members become hostile.

Entropic Shield

Level: Cleric 1
Range: Personal
Duration: 1 minute

A magical field of multi-colored hues deflects incoming ranged weapons and rays, giving you AC +4 against them.

Erase

Level: Magic-User 1
Range: 30'
Duration: Instantaneous

This spell removes writings magical or mundane from any surface. The writing must be touched to be erased.

ESP

Level: Magic-User 2
Range: 60'
Duration: 2 hours

The caster can detect the thoughts of other beings at a distance of 60'. The spell cannot penetrate more than 2' of stone, and is blocked by even a thin sheet of lead.

Ethereal Jaunt

Level: Cleric 7, Magic-User 7
Range: Personal
Duration: 1 minute

You and your gear become ethereal. For the duration of the spell, you are in a place called the Ethereal Plane, which overlaps the normal, physical, Material Plane. When the spell expires, you return to material existence.

An ethereal creature is invisible, insubstantial and capable of moving in any direction (including up and down) at half their movement rate. An ethereal creature can see and hear on the Material Plane, but everything looks gray and misty and sounds muffled. Force effects and abjuration spells affect ethereal creatures normally. Their effects extend into the Ethereal Plane from the Material Plane, but not vice versa. An ethereal creature cannot attack material creatures, and spells cast while ethereal affect only other ethereal things.

Etherealness

Level: Cleric 9, Magic-User 9
Range: Touch; see text
Duration: 10 minutes

As *ethereal jaunt* except that you can bring one willing creature per three caster levels. Once ethereal, the subjects need not stay together. When the spell expires, all affected creatures return to the Material Plane.

Expeditious Retreat

Level: Magic-User 1
Range: Personal
Duration: 1 minute

This spell increases your land movement rate by 30'. There is no effect on other modes of movement, such as burrowing, climbing, flying, or swimming.

Explosive Runes

Level: Magic-User 3
Range: Touch
Duration: Permanent until discharged

These mystic runes, when inscribed on an object, explode into a 10' radius fireball when they are read. This deals 5d6 points of fire damage. Those close enough to read the runes are not allowed a saving throw, while those further away may try a saving throw. The object on which the runes were inscribed must make an item saving throw or be destroyed.

Expunge

Level: Cleric 4
Range: Personal
Duration: 1 minute

When this spell is cast, all successful turn undead attacks made in the next minute deal 1d6 points of damage in addition to the normal turn undead effect.

Eyebite

Level: Magic-User 6
Range: 30'
Duration: See text

You may target a single living creature with waves of evil power. Creature with 0 to 4 HD are struck comatose for 1 hour. Creatures with 5 to 9 HD are frightened for 4 rounds and sickened for 1 hour. Creatures with 10 or more HD are sickened for 1 hour.

Fabricate

Level: Magic-User 5
Range: 30'
Duration: Instantaneous

You convert raw materials into a finished product (non-living and non-magical). The product can be up to 100 cubic feet in size. If you work with a mineral, the size is reduced to 10 cubic feet. Casting time is one round per 10 cubic feet (1 cubic foot for minerals) of material.

Faerie Fire

Level: Druid 1
 Range: 240'
 Duration: 1 minute

A pale glow surrounds and outlines all creatures within a 5' radius. Outlined creatures shed light as candles. They do not benefit from the concealment provided by *darkness*, *blur*, *displacement*, *invisibility* and similar effects. *Faerie fire* can be blue, green, or violet, according to your choice at the time of casting. The faerie fire does not cause any harm to the things it outlines.

False Forest

Level: Magic-User 4
 Range: 120'
 Duration: See text

As *tree shape*, but affects up to 10 creatures per caster level. Creatures under the spell's power must remain within 100 feet of the spell caster.

False Life

Level: Magic-User 2
 Range: Personal
 Duration: 3 hours or until discharged; see text

You harness the power of "un-life" to grant yourself a limited ability to avoid death. While this spell is in effect, you gain 2d6 temporary hit points.

False Vision

Level: Magic-User 5
 Range: Touch
 Duration: 1 day

Any scrying spell used to view anything within a 40' radius centered on you instead receives a false image defined by you at the time of casting.

Component: Jade dust worth 250 gp

Fear

Level: Magic-User 4
 Area: 120' cone
 Duration: 1 hour

An invisible cone of terror causes 6d6 Hit Dice of living creature in the area of effect to become frightened.

Feather Fall

Level: Magic-User 1
 Range: 30'
 Duration: Until landing

You float like a feather to the ground when you fall, suffering no damage. The spell can be cast with a single utterance to stop a person who is already falling. *Feather fall* works only upon free-falling objects. It does not affect a sword blow or a charging or flying creature.

Feeblemind

Level: Druid 5, Magic-User 5
 Range: 120'
 Duration: Permanent until dispelled

If the target creature fails a saving throw, its intelligence and charisma drop to 1. The affected creature cannot cast spells or communicate coherently. A creature that can cast magic-user spells saves at -4 against this spell.

Focus: Set of thieves' tools

Find Familiar

Level: Magic-User 2
 Range: 1 mile

A familiar is a spirit in the form of an animal that is bound to the soul of a magic-user. This familiar spirit bestows several benefits upon the magic-user, as it acts as a loyal servant, increases the magic-user's hit points and conveys certain abilities on the magic-user.

Find familiar can be attempted once per year, and the familiar spirit that is conjured is determined randomly. The ritual takes 1 hour to complete.

Special familiars are determined by alignment – Chaotic spellcasters attract quasits or imps, Lawful spellcasters attract brownies, and Neutrals attract pseudodragons.

d20	Familiar (Special Ability)
1-2	Bat (skilled at listening)
3-4	Cat (skilled at moving silently)
5	Hawk (skilled at finding secret doors)
6-7	Lizard (skilled at climbing walls)
8	Owl (darkvision 30')
9-10	Rat (+2 to save vs. disease)
11	Raven (+2 to save vs. fear)
12	Snake (+2 to save vs. poison)
13-14	Toad (+3 hit points)
15	Special
16-20	No familiar in range of spell

Familiars have the normal statistics for the animal they resemble, but are considered monsters rather than animals and have high intelligence. When a familiar is within 30 feet of its master, its own hit point total is added to the master's hit point total. If the familiar is killed, the magic-user loses hit points equal to twice the familiar's normal hit point total.

Component: Incense worth 100 gp

Find the Path

Level: Cleric 6, Druid 6

Range: Touch

Duration: 3 hr. indoors or underground; 1 day outdoors

The caster perceives the fastest way out of an area, even if the area is designed to be difficult to navigate, such as with mazes and bureaucracies.

Find Traps

Level: Cleric 2

Range: 30'

Duration: 20 minutes

You detect magical and non-magical traps.

Finger of Death

Level: Druid 8, Magic-User 7

Range: 30'

Duration: Instantaneous

You slay one living creature within range.



Fire Seeds

Level: Druid 6

Range: Touch

Duration: 1 hour or until used

You either turn up to four acorns into grenade-like weapons, or you turn eight holly berries into bombs that you can detonate on command.

Acorn grenades can be thrown 100' and deals 1 point of fire damage per caster level to a target they hit.

Berry bombs can only be tossed 5' and are detonated on your command, as long as you are within 200'. Each

berry deals fire damage equal to 1d8 + 1/caster level within a 5' radius.

Fire Shield

Level: Magic-User 4

Range: Personal

Duration: 1 minute

This spell wreathes you in flames, which illuminate as a normal torch. The flames protect you from cold- or fire-based attacks, your choice. Any creature striking you in melee suffers damage equal to 1d6 + 1/caster level. This damage is cold damage if the shield protects against fire-based attacks or fire damage if the shield protects against cold-based attacks. Creatures wielding weapons more than 5' long are not subject to this damage.

Fire Storm

Level: Druid 7

Range: 120'

Duration: Instantaneous

This spell causes an area 20' in radius per caster level to be shot through with sheets of flame. The flames do not harm natural vegetation, ground cover or plant creatures in the area that you wish to exclude. Other creatures in the area take 1d6 points of fire damage per caster level.

Fire Trap

Level: Druid 2, Magic-User 4

Range: Touch

Duration: Permanent until discharged

Fire trap creates a fiery explosion when an intruder opens the item that the trap protects. A fire trap can ward any object that can be opened and closed. When someone other than you opens the object, a fiery explosion fills the area within a 5' radius. The flames deal 1d4 points of fire damage +1 point per caster level. The item protected is not harmed by this explosion.

Component: Sulfur and saltpeter

Fireball

Level: Magic-User 3

Range: 240'

Duration: Instantaneous

A bead-like missile shoots from the caster's finger, to explode at the targeted location in a furnace-like blast of fire. An early impact against a solid object results in an early detonation. The burst radius is 20' and damage is

1d6 per level of the caster. *Fireballs* cast from wands and scrolls do 6d6 points of damage, while *fireballs* cast from staves do 8d6 points of damage. The blast shapes itself to the available volume, 33,000 cubic feet.

Fission

Level: Magic-User 7

Range: Personal

Duration: 1 minute

You split into two creatures. One is you, and the other is a perfect duplicate that thinks and acts exactly as you do, and follows your orders, although it will not do anything you would not do yourself. Your duplicate has all your abilities but none of your magical equipment, though it does possess a duplicate of all your mundane equipment, as well as mundane versions of any magical equipment you have. You and your duplicate evenly split your spells, your remaining uses of pertinent special abilities for the day, and so on. Treat your duplicate as yourself with two fewer levels. Spells or other effects affecting you when you cast this spell do not transfer to your duplicate.

When the duration expires or when you dismiss the spell, you and your duplicate rejoin, no matter how far from each other you are. You gain back any spells the duplicate has not cast. At the time of rejoining, you take half of the damage your duplicate has taken since this power was manifested.

If your duplicate dies before the duration expires, no rejoining occurs and you lose one level. If you die, your duplicate remains in existence and is, for all intents and purpose, you with two fewer levels.

You can have only one duplicate in existence at one time; your duplicate cannot use this spell. This spell cannot be made permanent.

Flame Arrow

Level: Magic-User 3

Range: 30'

Duration: 1 hour

You turn up to 50 arrows, bolts, shuriken, or bullets into fiery projectiles. Each piece of ammunition deals an extra 1d6 points of fire damage to any target it hits. A flaming projectile can ignite a flammable object or structure, but it does not ignite a creature it strikes.



Flame Blade

Level: Druid 2

Range: 0'

Duration: 10 minutes

A flaming scimitar springs forth from your hand. The blade deals 1d8 points of fire damage +1 point per caster level. A flame blade can ignite combustible materials such as parchment, straw, dry sticks, and cloth.

Flame Strike

Level: Cleric 5, Druid 4

Range: 120'

Duration: Instantaneous

A *flame strike* produces a vertical column (10' radius, 40' high) of divine fire roaring downward. The spell deals 1d6 points of damage per caster level. Half the damage is fire damage, but the other half is from divine power and is not subject to fire resistance.

Flaming Sphere

Level: Druid 2, Magic-User 2

Range: 120'

Duration: 1 round/level

A burning globe of fire rolls in whichever direction you point and burns those it strikes. It moves 30 feet per round. If it contacts a creature, it stops moving for the round and deals 2d6 points of fire damage to that creature, though a successful save negates that damage.

A *flaming sphere* rolls over barriers less than 4' tall. It ignites flammable substances it touches and illuminates the same area as would a torch. The sphere moves as long as you actively direct it; otherwise, it merely stays at rest and burns. It can be extinguished by any means that would put out a normal fire of its size. The surface of the sphere has a spongy, yielding consistency and so does

not cause damage except by its flame. It cannot push aside unwilling creatures or batter down large obstacles. A *flaming sphere* winks out if it leaves the spell's range.

Flare

Level: Druid 1, Magic-User 1
Range: 30'
Duration: Instantaneous

This spell creates a burst of light. If you cause the light to burst directly in front of a single creature, that creature is blinded for 1 minute unless it makes a successful save. Sightless creatures, as well as creatures already blinded, are not affected by *flare*.

Flesh to Stone/Stone to Flesh

Level: Magic-User 6
Range: 120'
Duration: Instantaneous

The target and its gear is turned to stone. If the statue is broken or damaged, the subject has similar damage or deformities when returned to normal. The creature is neither dead nor alive in this state.

The reverse transforms stone into flesh.

Fly

Level: Magic-User 3
Range: Touch
Duration: 1d6 turns plus 1 turn per level

The subject can fly at a rate of 60' (or 40' if wearing armor heavier than ringmail, or if encumbered).

Floating Disk

Level: Magic-User 1
Range: 30'
Duration: 1 hour

You create a circular plane of force that follows you and carries things for you. It can hold 100 pounds of weight per caster level. The disk floats 3 feet above the ground at all times and always remains level.

Fog Cloud

Level: Druid 2, Magic-User 2
Range: 120'
Duration: 1 hour

A bank of fog (20' radius, 20' high) obscures all sight, including darkvision.

Forbiddance

Level: Cleric 6
Range: 120'
Duration: Permanent

Forbiddance seals an area 60' in radius and 60' high against all planar travel into or within it. This includes teleportation, plane shifting, astral and ethereal travel and summoning spells. In addition, creatures with an alignment one step away from yours take 6d6 points of damage if they enter the area. Creatures with an alignment two steps away from yours suffer 12d6 points of damage. At your option, creatures can avoid the damage by speaking the password as they enter the area.

Component: Sprinkling of holy or unholy water, rare incense worth 3,000 gp

Fool's Gold

Level: Magic-User 1
Range: Touch
Duration: 1 hour + 10 minutes/level

You can temporarily turn copper or silver pieces into gold. The spell affects 2d4 coins + 1 per caster level.

Forcecage

Level: Magic-User 7
Range: 30'
Duration: 24 hours

This spell brings into being an immobile, invisible cubical prison composed either of bars of force or solid walls of force. A barred cage is a 20' cube (half-inch bars with half-inch gaps), while a windowless cell is a 10' cube. Creatures within the area are caught and contained unless they are too big to fit inside, in which case the spell fails. Teleportation and astral travel provide a means of escape, but the force barrier extends into the Ethereal Plane, blocking ethereal travel. Like a *wall of force* spell, a *forcecage* resists *dispel magic*, but it is vulnerable to a *disintegrate* spell, and can be destroyed by a *sphere of annihilation* or a *rod of cancellation*.

Component: Ruby dust worth 1,500 gp

Forceful Hand

Level: Magic-User 6
Range: 120'
Duration: 1 minute

This spell functions like *interposing hand*, except that the *forceful hand* pursues and pushes away the opponent that you designate. Treat this attack as a bull rush attack with a +14 attack bonus. The hand always moves with the opponent to push that target back the full distance allowed and it has no speed limit.

Foresight

Level: Druid 9, Magic-User 9

Range: Personal or touch

Duration: 3 hours

When this spell is cast, you receive instant warnings of impending danger or harm to the subject of the spell. You are never surprised. In addition, you have a general idea of what action you might take to best protect yourself and thus gain a +2 bonus to AC and saving throws.

When another creature is the subject of the spell, you must communicate what you learn to the other creature for the warning to be useful. The subject does not gain the bonus to AC and saving throws.

Free Action

Level: Cleric 4, Druid 4

Range: Personal or touch

Duration: 1 hour

You or a creature you touch move and attack normally for the duration of the spell even under the influence of magic that usually impedes movement. Grapple attacks against the subject always fail and escapes by the subject always succeed. The spell also allows the subject to move and attack normally while underwater, even with weapons that usually attack at a penalty there.

Freedom

Level: Magic-User 9

Range: 30'

Duration: Instantaneous

The subject is freed from spells and effects that restrict its movement. To free a creature from *imprisonment* or *maze*, you must know its name and you must cast this spell at the spot where it was entombed or en-mazed.

Freezing Sphere

Level: Magic-User 6

Range: 240'

Duration: Instantaneous or 1 minute; see text

You create a frigid globe of cold that streaks from your fingertips to the location you select where it explodes in a 10' radius burst, dealing 1d6 points of cold damage per caster level. A water elemental creature takes 1d8 points of cold damage per caster level. If the sphere strikes a body of water or a liquid that is principally water (not including water-based creatures), it freezes the liquid to a depth of 6 inches over an area equal to 100 square feet per caster level. This ice lasts for 1 round/caster level.

Fusion

Level: Magic-User 9

Range: Touch

Duration: 1 hour

You combine yourself and another willing creature. The fused being combines hit points, spells, special abilities, attacks and feats. The fused being has the better of the two creature's ability scores, Hit Dice and saving throws.

When the spell ends, the fused being separates. Damage taken by the fused being is split evenly between the fused creatures when the spell ends. You do not leave the fusion with more hit points than you entered it with, unless you healed while combined. Ability damage and negative levels are also split between you and the other creature. (If an odd number of negative levels or ability score reductions must be split, flip a coin.)

If a fused being is killed, it separates into its constituent creatures, both of which are also dead. You cannot use fission on a fused being. This spell cannot be made permanent.

Gaseous Form

Level: Magic-User 3

Range: Touch

Duration: 10 minutes

The subject and all its gear become an invisible gas. It cannot attack or cast spells, but can fly at a rate of 10'.

Gate

Level: Cleric 9, Magic-User 9

Range: 120'

Duration: See text

You create an opening to another plane and summon a specified being from that plane. The caster must know the name of the creature he is attempting to summon. There is a 5% chance that the wrong being is summoned. Regardless of whether the summoned being is correct or

not, there is a 5% chance that it lacks interest in the situation and returns through the *gate*. The summoned being is not necessarily friendly to the caster, and may even be extremely annoyed.

Geas

Level: Magic-User 6

Range: Sound of voice

Duration: Until task is completed

The caster may set a task for the spell's target. If the target does not diligently work at performing the task, he suffers a 50% reduction in strength. Trying to ignore the *geas* causes death (2 points of constitution damage per day). A *remove curse* spell ends a *geas* spell only if its caster level is at least two higher than your caster level. *Break enchantment* does not end a *geas*; that requires *limited wish*, *miracle*, and *wish*.

Genesis

Level: Cleric 9

Range: 180'

Duration: Instantaneous

When this spell is cast, a demi-plane is formed and grows at a rate of a 1-foot-radius per day to an initial maximum radius of 180 feet. A demi-plane is an immobile, finite plane with limited access. It can only be created on the Ethereal Plane.



The character determines the environment in the demi-plane when he or she first casts *genesis*, reflecting most any desire he or she can visualize. The caster determines factors such as atmosphere, water, temperature, and the shape of the general terrain. However, the spell cannot create life, nor can it create construction. If desired, these must be brought in by some other fashion.

Once the basic demi-plane reaches its maximum size, the character can continue to cast this spell to enlarge the demi-plane if he or she is inside its boundaries. The radius of the demi-plane increases by 60 feet per casting.

If the spell is cast again while outside an existing demi-plane, the casting creates a separate bubble that does not touch or overlap any previously created demi-plane.

Gentle Repose

Level: Cleric 2, Magic-User 3

Range: Touch

Duration: 1 week

You preserve a corpse so that it does not decay. The spell also works on severed body parts and cuts of meat.

Ghoul Touch

Level: Magic-User 2

Range: Touch

Duration: 1d6+2 rounds

This spell allows you to paralyze a single humanoid. The paralyzed subject exudes a carrion stench that causes all living creatures (except you) in a 10' radius to become sickened. *Neutralize poison* removes the effect. Creatures immune to poison are unaffected.

Component: Pinch of earth from a ghoul's lair

Giant Vermin

Level: Cleric 4, Druid 4

Range: 30'

Duration: 10 minutes

You turn three normal centipedes, two normal spiders, or a single normal scorpion into the giant monster versions of those creatures. Only one type of vermin can be transmuted at a time. Your control of these creatures is limited to simple commands. Unless commanded to do otherwise, they attack whoever is near them.

Glitterdust

Level: Magic-User 2
Range: 120'
Duration: 1d6 rounds

A cloud of golden particles 10' in radius covers everything in the area, blinding creatures and visibly outlining invisible things. The dust cannot be removed and sparkles until it fades.

Globe of Invulnerability I

Level: Magic-User 4
Area: 10' radius sphere
Duration: 1 minute

An immobile, shimmering magical sphere surrounds you and excludes all spell effects of 3rd level or lower. Spell can be cast by you through the globe or within it. Spells already in effect when the globe is cast are not affected.

Globe of Invulnerability II

Level: Magic-User 6
Area: 10' radius sphere
Duration: 1 minute

As *globe of invulnerability I*, except that it also excludes 4th-level spells.

Glyph of Warding

Level: Cleric 3
Range: Touch
Duration: Permanent until discharged

This inscription harms those who enter, pass, or open the warded area (up to 5 square feet per level) or object. Any creature entering the warded area or opening the warded object without speaking a password is subject to the spell. In addition to a password trigger, glyphs can be set according to physical characteristics (such as height or weight) or creature type, kind or alignment.

Glyphs can be dispelled. *Read magic* allows you to identify a glyph. Identifying the glyph does not discharge it and allows you to know its basic nature.

A blast glyph deals 1d6 points of damage per caster level to the intruder and all within 5 feet of him. This damage is acid, cold, fire, electricity, or sonic (caster's choice).

A spell glyph stores any harmful spell of 3rd level or lower that you know. If the spell has a target, it targets the intruder. If it summons creatures, they appear as close as possible to the intruder and attack.

Components: You trace the glyph with incense, which must first be sprinkled with powdered diamond worth 200 gp

Goodberry

Level: Druid 1
Range: Touch
Duration: 24 hours

Casting this on a handful of freshly picked berries makes 2d4 of them magical. Each magic berry provides nourishment as if it was a normal meal and heals one hit point of damage, subject to a maximum of eight points of such healing in any 24-hour period.

Grasping Hand

Level: Magic-User 7
Range: 120'
Duration: 1 minute

This spell functions like *interposing hand*, except the hand can also grapple one opponent that you select. The *grasping hand* gets one grapple attack per round with an attack bonus equal to your caster level. The hand holds but does not harm creatures it grapples. The *grasping hand* can also bull rush an opponent as *forceful hand* does, or interpose itself as *interposing hand* does.

Grease

Level: Magic-User 1
Range: 30'
Duration: 1d6 rounds

This spell covers 10 square feet of a solid surface with a layer of slippery grease. Any creature in the area must make a successful saving throw or fall. This save is repeated each round that the creature remains within the area. Movement over the grease is halved. The spell can also be used to create a greasy coating on an item.

Guards and Wards

Level: Magic-User 6
Range: Anywhere within the area to be warded
Duration: 24 hours

This spell wards 200 square feet per caster level. You must be somewhere within the warded area to cast the spell. The following effects are created within the area:

Fog fills all corridors, obscuring all sight, including darkvision, beyond 5 feet.

All doors in the warded area are *wizard locked*.

Webs fill all stairs from top to bottom. These strands are identical with those created by the *web* spell, except that they regrow in 10 minutes if they are burned or torn away while the *guards and wards* spell lasts.

Where there are choices in direction it is 50% probable that intruders go the opposite way they intended to go.

One door per caster level is covered by a *phantasmal force* to appear as if it were a plain wall.

In addition, you can place your choice of one of the following magical effects.

1. *Dancing lights* in four corridors.
2. A *magic mouth* in two places.
3. A *stinking cloud* in two places. The vapors return within 10 after being dispersed while the spell lasts.
4. A *gust of wind* in one corridor or room.
5. A *suggestion* in one place. You select an area of up to 5 feet square, and any creature who enters or passes through receives the suggestion mentally.

Component: Small silver rod, incense and a small amount of monster blood

Gust of Wind

Level: Druid 2, Magic-User 2
Range: 60'
Duration: 1 round

This spell creates a severe blast of air that originates from you, affecting all creatures in its path. All tiny and small creatures must pass a saving throw or be knocked prone and backward 3d6 feet. Medium creatures cannot advance into the wind. Any creature takes a -2 penalty on ranged attacks and listening at door in the area of a *gust of wind*. The force extinguishes candles, torches, and similar unprotected flames. It causes protected flames, such as those of lanterns, to dance wildly and has a 50% chance to extinguish those lights.

Hallow/Unhallow

Level: Cleric/Anti-Cleric 5
Range: Touch
Duration: Instantaneous

Hallow makes a site, building, or structure a holy site. This has four effects:

- The site is guarded by *protection from evil*.
- Turn undead is made at a +4 bonus.
- Dead bodies interred in a hallowed site cannot be turned into an undead creature.
- You may fix a single spell effect to the hallowed site. The spell effect lasts for one year and functions throughout the entire site regardless of the normal duration and area or effect. You may designate whether the effect applies to all creatures, creatures who share your faith or alignment, or creatures that adhere to another faith or alignment. At the end of the year, the effect lapses, but it can be renewed or replaced by casting *hallow* again.

An area can receive only one *hallow* spell at a time.

The reverse, *unhallow*, guards the site with *protection from good*, imposes a penalty on turn undead checks, does not prevent dead bodies from becoming undead, and permits a single spell effect to be fixed on the site.

Component: Herbs, oil and incense worth 1,000 gp + 1,000 gp/level of the spell to be included in the hallowed area

Hallucinatory Terrain

Level: Druid 4, Magic-User 4
Range: 240'
Duration: Until touched or dispelled

You make natural terrain look, sound, and smell like some other natural terrain. Structures, equipment and creatures within the area are not hidden or changed in appearance. The spell covers 30 square feet/caster level.

Haste

Level: Magic-User 3
Range: 30'
Duration: 30 minutes

One target per caster level doubles their movement rate and makes one extra attack per round.

Heal/Harm

Level: Cleric/Anti-Cleric 6, Druid 7
Range: Touch
Duration: Instantaneous

Heal enables you to wipe away injury and afflictions. It immediately ends any and all of the following conditions affecting the target: Ability damage (not drain), blinded,

confused, deafened, diseased, fatigued, *feeble-minded*, madness, sickened, stunned and poisoned.

It also cures 10 points of damage per level of the caster, to a maximum of 150 points at 15th level. The spell acts as *harm* against an undead creature.

Harm charges a subject with negative energy that deals 10 points of damage per caster level. If the creature successfully saves, *harm* deals half this amount, but it cannot reduce the target's hit points to less than 1. The spell acts as *heal* on undead creatures.

Healing Circle

Level: Cleric 5, Druid 6

Range: 20'

Duration: Instantaneous

Positive energy spreads out in all directions from the point of origin (up to a 30' radius area), curing 1d6+1 points of damage to one ally per level. Like *cure* spells, *healing circle* damages undead in its area rather than curing them.

Heat Metal/Chill Metal

Level: Druid 2

Range: 30'

Duration: 7 rounds

Heat metal makes metal extremely hot. On the first round of the spell, the metal becomes uncomfortable to touch but deals no damage. The same effect also occurs on the last round of the spell's duration. During the second (and also the penultimate) round, scorching hotness causes 1d4 points of fire damage to anyone touching the metal. In the third, fourth, and fifth rounds, the metal is blazing hot, causing 2d4 points of fire damage. Any cold intense enough to cause damage negates fire damage from the spell (and vice versa) on a point-for-point basis. Underwater, *heat metal* deals half damage and boils the surrounding water.

Chill metal works in the same way, but deals cold damage. Underwater, it deals no damage, but ice forms around the affected metal, making it more buoyant.

Helping Hand

Level: Cleric 3

Range: 5 miles

Duration: 5 hours

You create the ghostly image of a hand, which you can send to find a creature within 5 miles. The hand then

beckons to that creature and leads it to you if it is willing to follow. The hand can travel about 1 mile per hour. If, at the end of searching, the hand has found no subject that matches the description, it returns to you, displays an outstretched palm and disappears.

Heroes' Feast

Level: Cleric 6

Range: 30'

Duration: See text

You bring forth a great feast, including a magnificent table, chairs, service, and food and drink. The feast takes 1 hour to consume and the beneficial effects do not set in until the hour is over. Every creature partaking of the feast is cured of all diseases and sickness, becomes immune to poison and fear for 12 hours, gains 1d6 temporary hit points and gains a +1 bonus on attack rolls and saving throws. If the feast is interrupted, the spell is ruined and all effects are negated.

Heroism

Level: Magic-User 3

Range: Touch

Duration: 30 minutes

This spell imbues a single creature with great bravery and morale in battle. The target gains a +2 bonus on attack rolls and saving throws.

Hide from Animals

Level: Druid 1

Range: Touch

Duration: 10 minutes

The spell caster can ward up to one creature per level. Animals cannot see, hear, or smell the warded creatures through natural or supernatural means. If a warded character touches an animal or attacks any creature, even with a spell, the spell ends for all recipients.

Hideous Laughter

Level: Magic-User 2

Range: 30'

Duration: 1d6 rounds

This spell causes the subject to collapse into gales of manic laughter, falling prone. The subject can take no actions while laughing, but can defend itself. After the spell ends, it can act normally.

Hold Animal

Level: Druid 2
 Range: 120'
 Duration: 90 minutes

This spell functions like *hold person*, except that it affects an animal instead of a humanoid.

Hold Monster

Level: Druid 5, Magic-User 5
 Range: 120'
 Duration: 1 hour

This spell functions like *hold person*, except that it affects any creature that fails its saving throw.

Hold Person

Level: Cleric 2, Magic-User 3
 Range: 120'
 Duration: 90 minutes

The caster immobilizes 1d4 humanoids. The caster can instead target a single humanoid, in which case they suffer a -2 penalty to save.

Hold Portal

Level: Magic-User 1
 Range: 120'
 Duration: 2d6 turns

This spell holds a door closed for the spell's duration or until dispelled. Creatures with magic resistance can break the spell without effort.

Hold Undead

Level: Magic-User 3
 Range: 120'
 Duration: 1 hour + 10 minutes/level

As *hold person*, but affects undead instead of humanoids.

Holy Aura/Unholy Aura

Level: Cleric/Anti-Cleric 8
 Area: 20' radius centered on you
 Duration: 1 hour

A brilliant radiance surrounds the subjects in the area, protecting them in four ways. First, each warded creature gains a +2 bonus to AC and a +2 bonus on saves. Unlike *protection from evil*, this benefit applies against all attacks, not just against attacks by Chaotic creatures. Second, each warded creature gains magic resistance

20% against evil spells and spells cast by Chaotics. Third, the abjuration blocks possession and mental influence, just as *protection from evil* does. Finally, if a Chaotic creature succeeds on a melee attack against a warded creature, the attacker is *blinded*.

Unholy aura is the reverse of *holy aura*.

Component: A tiny reliquary containing a sacred relic, such as the finger bone of a saint

Holy Word/Unholy Word

Level: Cleric/Anti-Cleric 7
 Area: 40' radius centered on you
 Duration: Instantaneous

The speaking of *holy word* affects all Chaotic creatures within range. Creatures of fewer than 5 hit dice are slain, creatures of 5 to 8 hit dice are stunned for 2d10 turns, and creatures with 9-12 hit dice are deafened for 1d6 turns. Creatures with 13 or more hit dice are unaffected.

The reverse, *unholy word*, affects Lawful creatures.

Horrid Wilting

Level: Druid 9, Magic-User 8
 Range: 240'
 Duration: Instantaneous

This spell evaporates moisture from the body of each living creature within 60', dealing 1d6 points of damage per caster level. Water elementals and plant creatures take 1d8 points of damage per caster level.

Hypnotic Pattern

Level: Magic-User 2
 Range: 120'
 Duration: Concentration + 2 rounds

This spell fascinates 4d6 Hit Dice of creatures who see it. The creatures stand still, staring at the pattern.

Hypnotism

Level: Magic-User 1
 Range: 30'
 Duration: 2d4 rounds

You fascinate nearby creatures, causing them to stop and stare blankly at you. In addition, you can use their rapt attention to make your suggestions and requests seem more plausible. Roll 2d4 to see how many total Hit Dice of creatures you affect. Creatures with fewer HD are affected before creatures with more HD. Only creatures

that can see or hear you are affected, but they do not need to understand you to be fascinated. In combat, each target gains a +2 bonus on its saving throw.

While the subject is fascinated by this spell, you may make a single request of the affected creature. The request must be brief and reasonable. A creature that fails its save does not remember that you hypnotized it.

Ice Storm

Level: Druid 4, Magic-User 4
Range: 240'
Duration: 1 round

A whirling vortex of ice, snow, and hail forms in a cube roughly 30' across. Massive hailstones inflict 3d10 hit points of damage (no saving throw) to all in the area.

Identify

Level: Magic-User 1
Range: Touch
Duration: Instantaneous

The spell determines all magic properties of a single magic item, including how to activate those functions and how many charges are left. Identify does not work on an artifact. The spell requires a pearl be crushed and stirred into wine with an owl feather. The infusion must be drunk prior to spell casting.

Component: Pearl worth 100 gp

Ill Omen

Level: Magic-User 1
Range: 30'
Duration: Until discharged

You afflict the target with bad luck. On the next d20 roll the target makes, it must roll twice and take the less favorable result. For every five caster levels you have, the target must roll an additional time.

Illusory Script

Level: Magic-User 3
Range: Touch
Duration: One week

When you write information on parchment, paper, or any suitable writing material, *illusory script* makes it appear to be some form of foreign or magical writing. Only people designated by you when the spell is cast are able to read the writing. Unauthorized creatures attempting

to read the script trigger a potent illusory effect and are subject to a *suggestion*. The suggestion lasts 30 minutes.

Component: Lead-based ink costing 50 gp

Illusory Wall

Level: Magic-User 4
Range: 30'
Duration: Permanent

This spell creates the illusion of a wall, floor, ceiling, or similar surface up to 10 feet long and 10 feet wide. It appears absolutely real when viewed, but physical objects can pass through it without difficulty.

Imbue with Spell Ability

Level: Cleric 4
Range: Touch
Duration: Permanent until discharged

You transfer some of your prepared spells and the ability to cast them to another creature. Only a creature with an intelligence score of at least 5 and a wisdom score of at least 9 can receive this bestowal. Only defensive, divinatory and healing spells can be transferred. The number and level of spells that the subject can be granted depends on its Level/Hit Dice. Multiple castings of *imbue with spell ability* cannot exceed this limit.

Subject's	
Level	Level of Spells That Can be Imbued
0-2	One 1st-level spell
3-4	One or two 1st-level spells
5 +	One or two 1st-level and one 2nd-level spell

The transferred spell's variable characteristics function according to your level, not the level of the recipient.

Immunity to Energy

Level: Cleric 9, Druid 9
Range: Touch
Duration: 24 hours

This spell grants a creature total immunity from damage of whichever of the following energy types you select: Acid, cold, electrical, fire or sonic. This spell protects the subject's equipment as well. The spell grants immunity to damage only; the subject can still suffer side effects, such as drowning or being encased in ice.

Implosion

Level: Cleric 9

Range: 30'

Duration: Concentration (up to 4 rounds)

Each round that you concentrate, you cause one creature to implode and die. You may target a particular creature once with each casting of the spell.

Imprisonment

Level: Magic-User 9

Range: Touch

Duration: Instantaneous

When you cast *imprisonment* and touch a creature, it is entombed in a state of suspended animation in a small sphere far beneath the surface of the earth. The subject remains there unless a *freedom* spell is cast at the locale where the imprisonment took place. Magical search by a *crystal ball*, a *locate object* spell or some other similar divination does not reveal the fact that a creature is imprisoned. *Discern location* reveals the location of an imprisoned creature. A *wish* or *miracle* spell does not free the recipient, but reveals where it is.

Incendiary Cloud

Level: Magic-User 8

Range: 120'

Duration: 1 minute

You create a cloud of roiling smoke shot through with white-hot embers. The cloud is 20' in radius and 20' high. The smoke obscures all sight as a *fog cloud*. In addition, the embers deal 4d6 points of fire damage to everything within the cloud on your turn each round. All targets can make saving throws each round to take only half damage. Wind disperses the smoke and the spell cannot be cast underwater.

Insanity

Level: Magic-User 7

Range: 120'

Duration: Instantaneous

The target of this spell is driven mad. Only *heal*, *limited wish*, *miracle*, or *wish* can restore the creature.

Insect Plague

Level: Cleric 5, Druid 4

Range: 240'

Duration: 1 day

This spell only works outdoors. A storm of insects gather and goes where the caster directs. The cloud is 20' in radius and 20' high. Any creature of 2 HD or less that is exposed to the cloud of insects flees in terror (no save).

Instant Summons

Level: Magic-User 7

Range: See text

Duration: Permanent until discharged

You call a non-living item from any location directly to your hand. You must place your *wizard mark* on the item to do so. You then cast this spell, which magically and invisibly inscribes the name of the item on a sapphire worth at least 1,000 gp. Thereafter, you can summon the item by speaking a password and crushing the gem. Only you can use the gem in this way. If the item is in the possession of another creature, the spell does not work, but you know who the possessor is and where they are when the summons occurs.

Component: Sapphire worth 1,000 gp

Intellect Fortress

Level: Magic-User 4

Range: 20' radius centered on caster

Duration: 1 round

You encase yourself and your allies in a fortress of pure mental will. All damage from mind-affecting effects, including those that deal charisma, intelligence or wisdom damage, is halved. If you have this spell memorized, you can cast it when it is not your turn with a single utterance, including just before you are attacked.

Intelligence

Level: Cleric 2, Magic-User 2

Range: Touch

Duration: 1 hour

The spell grants the subject 18 intelligence. This cannot be made permanent.

Interposing Hand

Level: Magic-User 5

Range: 120'

Duration: 1 minute

Interposing hand creates a large magic hand that appears between you and an opponent. This floating hand then moves to remain between the two of you, regardless of where you move or how the opponent tries to get around

it, providing a +2 AC for you against that opponent. Nothing can fool the hand—it sticks with the selected opponent in spite of darkness, *invisibility*, *polymorph* or any other attempt at hiding or disguise. The hand does not, however, pursue an opponent.

An *interposing hand* is 10 feet long and about that wide with its fingers outstretched. It has as many hit points as you do when you're undamaged, and its AC is 20. It takes damage as a normal creature, but most magical effects that do not cause damage do not affect it.

Invisibility

Level: Magic-User 2

Range: 120'

Duration: Until dispelled or attack is made

The creature (and its gear) or object touched becomes invisible, vanishing from sight. Items dropped or put down by an invisible creature become visible; items picked up disappear if tucked into the clothing or pouches worn by the creature. If the invisible creature attacks, the spell ends. The invisible creature cannot be attacked unless its approximate position is known.

Invisibility II

Level: Magic-User 4

Range: 120'

Duration: 1 minute

As *invisibility*, except that it does not end if the subject attacks another creature.

Invisibility Purge

Level: Cleric 3

Range: Personal

Duration: 5 minutes

You surround yourself with a sphere of power with a 5' radius per caster level that negates all invisibility.

Invisibility Sphere

Level: Magic-User 3

Area: 10' radius centered on you

Duration: Until dispelled or attack is made

Like *invisibility*, this spell makes the target creature or object invisible. It also throws a 10' radius of invisibility around the recipient, which moves with it. The spell ends if the invisible creature attacks.

Invisibility to Undead

Level: Cleric 1

Range: Touch

Duration: 10 minutes

As *hide from animals*, except that the spell only affects undead creatures.

Iron Body

Level: Magic-User 8

Range: Personal

Duration: 30 minutes

This spell transforms your body into living iron. You suffer half damage from non-magical or non-adamantine weapons. You are immune to blindness, critical hits, ability damage, deafness, disease, drowning, electricity, poison, stunning and all spells or attacks that affect your physiology or respiration. You take only half damage from acid and fire of all kinds. You also become vulnerable to special attacks that affect iron golems.

Your strength increases to 18 and your dexterity can be no higher than 7. Your speed is reduced to half normal. You have a spell failure chance of 50% if you are a magic-user or sorcerer. You cannot drink (and thus can't use potions) or play wind instruments. Your unarmed attacks deal 1d6 points of damage.

Your weight increases by a factor of ten, causing you to sink in water. Fortunately, you can survive the crushing pressure and lack of air at the bottom of the ocean until the spell duration expires.

Ironwood

Level: Druid 6

Range: Touched

Duration: 1 week

Ironwood is a magical substance created by druids from normal wood. While remaining natural wood in almost every way, ironwood is as strong, heavy, and resistant to fire as steel. Spells that affect metal or iron do not function on ironwood. Spells that affect wood do affect ironwood, although ironwood does not burn.



Irresistible Dance

Level: Magic-User 8
Range: Touch
Duration: 1d4+1 rounds

The subject feels an undeniable urge to dance and begins doing so, complete with foot shuffling and tapping. The spell effect makes it impossible for the subject to do anything other than caper and prance in place. The effect imposes a -2 penalty to AC and a -5 penalty on saves.

Jump

Level: Druid 1, Magic-User 1
Range: Touch
Duration: 1 minute

The subject can leap three times as far as normal.

Keen Edge

Level: Magic-User 3
Range: 30'
Duration: 1 hour

This spell makes a weapon magically keen, improving its ability to deal telling blows. The weapon deals maximum damage while the spell lasts.

Knock

Level: Magic-User 2
Range: 120'
Duration: Instantaneous; see text

This spell unlocks and unbars all doors, gates, and portals within its range, including those held or locked by normal magic.

Know Alignment

Level: Cleric 2, Druid 3, Magic-User 2
Area: 30' radius centered on you
Duration: 1 minute

You instantly know the alignment of any creature within the area of effect. The spell can penetrate barriers, but one foot of stone, one inch of common metal, a thin sheet of lead or three feet of wood or dirt blocks it.

Know Direction

Level: Druid 1
Range: Personal
Duration: Instantaneous

You instantly know which direction is north.

Legend Lore

Level: Magic-User 6
Range: Personal
Duration: Instantaneous

You learn legends about an important person, place, or thing. If the person or thing is at hand, or if you are in the place in question, the casting time is 1d4 x 10 minutes. If you have only detailed information on the person, place, or thing, the casting time is 1d10 days. If you know only rumors, the casting time is 2d6 weeks.

If the person, place, or thing is not of legendary importance, you gain no information. As a rule of thumb, characters who are 11th level and higher are "legendary," as are the sorts of creatures they contend with, the major magic items they wield, and the places where they perform their key deeds.

Component: Incense, four strips of ivory formed into a rectangle and one treasure must be sacrificed

Levitate

Level: Magic-User 2
Range: Personal or 30'
Duration: 1 turn/level

You to move yourself, another willing creature, or an unattended object up and down as you wish. You can mentally direct the recipient to move up or down as much as 20' each round. You cannot move the recipient horizontally, but the recipient could clamber along the face of a cliff, for example, or push against a ceiling to move laterally at half speed.

Light

Level: Cleric 1, Druid 1, Magic-User 1
Range: Touch
Duration: 2 hours

This spell causes an object to glow like a torch.

Lighten Burden

Level: Druid 2
Range: Touch
Duration: 1 hour

For the duration of the spell, a recipient of *lighten burden* can carry 50% more than normal for its strength.

Lightning Bolt

Level: Magic-User 3
Range: 120'
Duration: Instantaneous

A bolt of lightning extends instantly to its target. The bolt is almost 10' wide. Anyone in its path suffers 1d6 points of damage per level of the caster. The bolt always extends at least 60', even if this means that it ricochets backward from something that blocks its path.

Limited Wish

Level: Magic-User 7
Range: See text
Duration: Changes reality

This spell is a weak version of *wish*. *Limited wish* cannot create or bring treasure to the caster, and under some circumstances only a part of the limited wish might actually be fulfilled. The spell does have the power to reach for a limited period of time into the past or future as well as the present.

Liveoak

Level: Druid 6
Range: Touch
Duration: 1 week

This spell turns a single huge, healthy oak into a treant.

Locate Creature

Level: Magic-User 4

This spell functions like *locate object*, except it locates a creature. The spell is blocked by running water.

Locate Object

Level: Cleric 3, Magic-User 2
Range: 500'
Duration: Instantaneous

This spell gives the caster the correct direction (as the crow flies) toward an object the casters specifies with a description. The object cannot be something the caster has never seen, although the spell can detect an object in a general class of items known to the caster, such as stairs, gold, swords, etc.

Longstrider

Level: Druid 1
Range: Personal
Duration: 1 hour

This spell increases your land movement rate by 10'. It has no effect on other modes of movement.

Mage Armor

Level: Magic-User 1
Range: Touch
Duration: 1 hour

An invisible but tangible field of force surrounds the subject of *mage armor*, providing protection equivalent to scale mail armor (AC 14).

Mage Hand

Level: Magic-User 1
Range: 30'
Duration: Concentration

You point your finger at an object up to 5 lb. in weight and lift it and move it at will. You can propel the object as far as 15' in any direction, though it cannot be more than the spell's range in feet away from you.

Mage's Disjunction

Level: Magic-User 9
Range: 40'
Duration: Instantaneous

All magical effects and magic items within range, except for those that you carry or touch, are ended, and each character holding a magic item must make a successful saving throw or that item is turned into a normal item. You also have a 1% chance per caster level of destroying an *antimagic field*. If the *antimagic field* survives the disjunction, no items within it are affected.

Mage's Faithful Hound

Level: Magic-User 5
Range: 30'
Duration: Until discharged, then 1 round/level

You conjure up a phantom watchdog that is invisible to everyone but yourself. It guards the area where it was conjured and it does not stray far from that place. The hound barks if any dangerous creature approaches within 30' of it. It sees invisible and ethereal creatures, and does not react to illusions.

If an intruder approaches within 5' of the hound, it stops barking and delivers a bite (+10 to attack, 2d6 damage) once per round.

The spell lasts for 1 hour per caster level until the hound begins barking and 1 round per level thereafter. If you are more than 100' from the hound, the spell ends.

Mage's Lucubration

Level: Magic-User 6
Range: Personal
Duration: Instantaneous

You instantly recall any one spell of 5th level or lower that you have used during the past 24 hours. The spell must have been actually cast during that period. The recalled spell is stored in your mind as though prepared in the normal fashion.

Mage's Magnificent Mansion

Level: Magic-User 7
Range: 30'
Duration: 24 hours

You conjure an extra-dimensional dwelling that has a single entrance. The entry point looks like a faint shimmering in the air that is 4 feet wide and 8 feet high. Only those you designate may enter the mansion and the portal is shut and made invisible behind you when you enter. You may open it again from your own side at will. Once observers have passed beyond the entrance, they are in a magnificent foyer with numerous chambers beyond. The atmosphere is clean, fresh, and warm.

You can create any floor plan you desire to the limit of the spell's effect (1 room per level). The place is furnished and contains sufficient foodstuffs to serve a nine-course banquet to a dozen people per caster level. A staff of *unseen servants* (two per caster level), which are liveried and obedient, wait upon all who enter.

Since the place can be entered only through its special portal, outside conditions do not affect the mansion, nor do conditions inside it pass to the plane beyond.

Mage's Private Sanctum

Level: Magic-User 5
Range: 30'
Duration: 24 hours

Anyone looking into the protected area (30 cubic feet per level) from outside sees only a dark mass. Darkvision cannot penetrate it. No sounds, no matter how loud, can escape the area, so nobody can eavesdrop from outside. Those inside can see out normally. Divinations cannot

perceive anything within the area, and those within are immune to *ESP*.

Mage's Sword

Level: Magic-User 7
Range: 30'
Duration: 1 minute

This spell creates a shimmering sword of force. The sword strikes at any opponent within its range that you indicate starting in the round that you cast the spell. The sword attacks its designated target once each round on your turn. Its attack bonus is equal to your caster level. It deals 4d6 points of damage. The sword cannot be attacked or harmed by physical attacks, but *dispel magic*, *disintegrate*, a *sphere of annihilation*, or a *rod of cancellation* affects it.

Focus: Miniature platinum sword with a grip and pommel of copper and zinc (250 gp to construct)

Magic Aura

Level: Magic-User 1
Range: Touch
Duration: One day

You alter an item's aura so that it registers to detect spells (and spells with similar capabilities) as though it were non-magical, or a magic item of a kind or the subject of a spell you specify.

Magic Fang

Level: Druid 1
Range: Touch
Duration: 1 hour

You give one natural attack (bite, claw, sting, tail, etc.) of the subject a +1 bonus on attack and damage and the ability to harm creatures only harmed by magic weapons.

Magic Jar

Level: Magic-User 5
Range: See text
Duration: See text

This spell relocates the caster's life essence, intelligence, and soul into an object of virtually any kind. The jar must be within 30' of the caster's body for the transition to succeed. Once within the *magic jar*, the caster can possess the bodies of other creatures and people, provided that they are within 120' of the jar and fail a saving throw. The caster can return his soul to the *magic*

jar at any time, and if a body he controls is slain, his life essence returns immediately to the jar.

If the caster's body is destroyed while his soul is in the *magic jar*, the soul no longer has a home other than within the *magic jar* (although the disembodied magician can still possess other bodies as before). If the jar itself is destroyed while the magician's soul is within, the soul is lost. The magician can return from the jar to his own body whenever desired, thus ending the spell.

Magic Missile

Level: Magic-User 1

Range: 120'

Duration: Instantaneous

There are two versions of this spell, and your TK specifies which version is available in his campaign.

In the first version, the magic-user must roll to attack the target with his *magic missile*, with a +1 bonus to the roll. The missile inflicts 1d6+1 points of damage.

In the second version of the spell, the missile never misses its target and does 1d4+1 damage.

In either case, the magic user throws an additional 2 missiles for every 5 levels.

Magic Mouth

Level: Magic-User 2

Range: 30'

Duration: Permanent until discharged

This spell is cast upon an object and the magic is triggered when conditions established by the caster are met. When that happens, a mouth appears in the object and speaks the message it has been commanded to speak. The message may be 30 words long.



Magic Resistance

Level: Cleric 5

Range: Touch

Duration: 1 hour

The creature gains magic resistance equal to 5% times your caster level, to a maximum of 95%.

Magic Stone

Level: Cleric 1, Druid 1

Range: Touch (to enchant stone)

Duration: 30 minutes or until discharged

You transmute as many as three pebbles so that they strike with great force when thrown or slung. If hurled, they have an effective range of 20 feet. If slung, treat them as sling bullets for range. They are +1 to attack and they deal 1d6+1 points of damage (2d6+2 vs. undead).

Magic Vestment

Level: Cleric 3

Range: Touch

Duration: 6 hours

You imbue a suit of clothing with a base AC of 10 +1 per four caster levels.

Magic Weapon

Level: Cleric 1, Magic-User 1

Range: Touch

Duration: 1 hour

You give a weapon a +1 magic bonus on attack and damage rolls. You cannot cast this spell on a natural weapon, such as claws or a bite.

Make Whole

Level: Cleric 2

Range: 30'

Duration: Instantaneous

As *mending*, except that it completely repairs an object made of any substance, even one with multiple breaks, to be as strong as new. The spell does not restore the magical abilities of a broken magic item made whole, and it cannot mend broken magic rods, staves, or wands. The spell does not repair items that have been warped, burned, disintegrated, ground to powder, melted, or vaporized, nor does it affect creatures.

Mark of Justice

Level: Cleric 5

Range: Touch

Duration: Permanent; see text

You draw an indelible mark on the subject and state some behavior on the part of the subject that activates the mark. When activated, the mark curses the subject. Typically, you designate some sort of criminal behavior that activates the mark, but you can pick any act you please. The effect of the mark is identical with the effect of *bestow curse*. You can cast the spell only on a creature that is willing or restrained.

Mass Charm

Level: Magic-User 8
Range: 120'
Duration: Until dispelled

As *charm person*, but it affects a total of 30 HD of creatures. All saving throws are made by these creatures at a -1 penalty.

Mass Invisibility

Level: Magic-User 7
Range: 240'
Duration: See text

As *invisibility*, but it makes 1d3 x 100 man- or horse-sized creatures or objects invisible. The spell can also affect up to 6 creatures of large size.

Mass Suggestion

Level: Magic-User 6
Range: 120'
Duration: 1 day

As *suggestion*, except that it affects up to one creature per caster level.

Mathemagic Principle

Level: Magic-User 6
Range: Personal
Duration: 1 round

This spell allows the caster to optimize his next spell. The spell does not work if the next spell is not cast immediately, even before taking a step.

When this spell is cast, the caster must make a saving throw with a penalty equal to the level of the spell to be affected. Failure causes backlash that deals 1d6 points of damage per level of the affected spell and wastes the *mathemagic principle*. Success causes the next spell the spellcaster casts to be cast with all variables maximized.

Focus: Piece of slate worth 100 gp and three chalk sticks of different colors

Maze

Level: Magic-User 8
Range: 30'
Duration: See text

The targeted creature disappears into a gap in reality, where strange curving and branching passages conceal the way out. Creatures with an intelligence score lower than 8 (low or animal for monsters) require 6d4 minutes to escape. Creatures with intelligence scores of 9 to 12 (average intelligence) require 2d4 rounds and creatures with an intelligence of 13 or higher (high or super intelligence) require 1d4 rounds to puzzle the way back into normal reality. No save allowed against this spell.

Meld into Stone

Level: Cleric 3, Druid 3
Range: Personal
Duration: 1 hour

You can meld your body and gear into a block of stone. The stone must be large enough to accommodate your body. When the casting is complete, you and up to 100 pounds of non-living gear merge with the stone. While in the stone, you remain aware of the passage of time and can cast spells on yourself. You cannot see outside of the stone, but you can still hear what happens around you. The stone's destruction expels and slays you instantly unless you make a saving throw.

Any time before the end of the duration, you can step out of the stone through the surface that you entered. If the spell's duration expires or the effect is dispelled before you voluntarily exit the stone, you are violently expelled and take 5d6 points of damage.

Mending

Level: Cleric 1, Druid 1, Magic-User 1
Range: 10'
Duration: Instantaneous

You mend small breaks or tears in objects. The spell can repair a magic item, but not restore its magical abilities. The spell does not affect creatures (including constructs).

Mental Barrier

Level: Magic-User 3
Range: Personal
Duration: 1 round

You project a field of improbability around yourself. You gain a +4 bonus to Armor Class. If you have this spell memorized, you can cast it when it is not your turn with a single utterance, including just before you are attacked.

Message

Level: Magic-User 1
Range: 120'
Duration: 10 minutes

You can whisper messages and receive whispered replies with little chance of being overheard. You point your finger at each creature you want to receive the message. When you whisper, the whispered message is audible to all targeted creatures within range. Magical silence, 1' of stone, 1" of common metal (or a thin sheet of lead), or 3 feet of wood or dirt blocks the spell.

Meteor Swarm

Level: Magic-User 9
Range: 240'
Duration: Instantaneous

When you cast this spell, four 2' diameter meteors spring from your outstretched hand and streak in straight lines to the spots you select. The meteors leave a fiery trail.

If you aim a sphere at a specific creature, you make a ranged attack to hit the target for 2d6 points of damage (no save) plus 6d6 points of fire damage in a 40' radius (save for half damage). You may aim more than one meteor at the same target.

Mind Blank

Level: Magic-User 8
Range: 30'
Duration: 24 hours

This spell protects against all mind-affecting spells and effects as well as information gathering by divination spells or effects.

Mind Fog

Level: Magic-User 5
Range: 120'
Duration: 30 minutes and 2d6 rounds; see text

Mind fog produces a bank of thin mist 20' in radius and 20' high that weakens the mental resistance of those caught in it. Creatures in the mind fog take a -10 penalty on saving throws. Affected creatures suffer the penalty as long as they remain in the fog and for 2d6 rounds

thereafter. The fog is stationary and lasts for 30 minutes or until dispersed by wind.

Mind Thrust

Level: Magic-User 1
Range: 30'
Duration: Instantaneous

You instantly deliver a massive assault on the brain of any one creature, dealing 1d8 points of damage to it.

Miracle

Level: Cleric 9
Range: See text
Duration: See text

You request a miracle from a deity. You state what you want to have happen and request their intercession. In general, *miracle* is as powerful as *wish*. A request that is out of line with a deity's nature is refused.

Mirage Arcana

Level: Magic-User 5
Range: 240'
Duration: 12 hours

This spell functions like *hallucinatory terrain*, except that it enables you to make an area 20 cubic feet per level appear to be something other than it is. The illusion includes audible, visual, tactile, and olfactory elements. The spell can alter the appearance of structures (or add them where none are present). It cannot disguise, conceal or add creatures.

Mirror Image

Level: Magic-User 2
Range: Personal; see text
Duration: 1 hour or until destroyed



This spell creates 1d4 images of the caster that act in perfect synchronization with him like mirror images. Attackers cannot distinguish the images from the caster, and may attack one of the images instead of the caster himself (determined randomly). When a hit is scored upon one of the images, it disappears.

Misdirection

Level: Magic-User 2
Range: 30'
Duration: 3 hours

This spell makes divination spells malfunction so that they give their caster faulty information. The percent chance of malfunction is equal to the level of the divination's caster divided by your level.

Mislead

Level: Magic-User 6
Range: 30'
Duration: 1 minute and concentration + 3 rounds

You become invisible per *invisibility II*, and at the same time an illusory double of you appears. You are then free to go elsewhere while your double moves away. The double moves at your speed and can talk and gesture as if it was real, but it cannot actually attack or cast spells.

Mnemonic Enhancer

Level: Magic-User 4
Range: Personal
Duration: Instantaneous

When you cast this spell you can either prepare up to three additional levels worth of spells or you retain any spell of 3rd level or lower that you had cast up to 1 round before you cast this spell. The spell or spells prepared or retained fade after 24 hours if not cast.

Component: Ivory plaque worth 50 gp

Moment of Prescience

Level: Magic-User 8
Range: Personal
Duration: 24 hours

This spell grants you a powerful sixth sense in relation to yourself. Once during the spell's duration, you may choose to use its effect. This spell grants you a bonus equal to your caster level on any single attack roll or saving throw. Alternatively, you can apply the bonus to your Armor Class against a single attack.

Mount

Level: Magic-User 1
Range: 30'
Duration: 2 hours

You summon a light horse or a pony to serve you as a mount. The steed serves willingly and well. The mount comes with a bit and bridle and a riding saddle.

Move Earth

Level: Druid 6, Magic-User 6
Range: 240'
Duration: 1 hour, effect permanent

This spell can only be used above ground. It allows the caster to move hills and other raised land or stone at a rate of 6 feet per minute, or 60 feet per turn.

Negative Energy Protection

Level: Cleric 4, Druid 5
Range: Touch
Duration: 1 hour

The subject is immune to all death spells, magical death effects and energy damage and drain. This spell does not restore levels that the subject has already lost, nor does it protect from other sorts of lethal attacks.

Neutralize Poison

Level: Cleric 4, Druid 3
Range: Touch
Duration: Immediate

This spell counteracts poison if used promptly, but cannot be used to bring the dead back to life after they have perished from poisoning.

Nightmare

Level: Magic-User 5
Range: Unlimited
Duration: Instantaneous

You send an unsettling vision to a creature. The nightmare prevents restful sleep and causes 1d10 points of damage. The nightmare leaves the subject fatigued and unable to regain magic-user spells for the next 24 hours.

Dispel evil cast on the subject while you are casting the spell dispels the nightmare and causes you to be stunned for 10 minutes per caster level of the *dispel evil*.

Nondetection

Level: Magic-User 3
 Range: Touch
 Duration: 6 hours

The warded creature cannot be detected by divination spells and *crystal balls*.

Component: Diamond dust (50 gp worth)

Obscure Object

Level: Magic-User 2
 Range: Touch
 Duration: 8 hours

This spell hides an object from location by divination effects, such as *scrying* or a *crystal ball*. Such an attempt automatically fails (if the divination is targeted on the object) or fails to perceive the object (if the divination is targeted on a nearby location, object, or person).

Obscuring Mist

Level: Druid 1, Magic-User 1
 Area: 20' radius centered on caster
 Duration: 1 minute

A misty vapor surrounds you and is stationary once created. It obscures all sight, including darkvision, beyond 5'. A creature up to 5' away is -4 to be hit. Creatures farther away are -10 to be hit. This spell does not function underwater.

Open/Close

Level: Magic-User 1
 Range: 30'
 Duration: Instantaneous

You can open or close a door, chest, box, window, bag, pouch, bottle, barrel, or other container. If anything resists this activity (such as a bar on a door or a lock on a chest), the spell fails. In addition, the spell can only open and close things weighing 30 pounds or less. Thus, doors, chests, and similar objects sized for enormous creatures may be beyond this spell's ability to affect.

Overland Flight

Level: Magic-User 5
 Range: Personal
 Duration: 8 hours

As *fly* except that you travel at 8 miles per hour.

Passwall

Level: Magic-User 5
 Range: Touch
 Duration: 30 minutes

This spell creates a hole through solid rock 7' high, 10' wide and 10' deep. It closes when the spell ends.

Pass through Element

Level: Magic-User 2
 Range: Personal
 Duration: 10 minutes

When you cast this spell you select a naturally occurring substance. You can walk as far as 5' per caster level through that chosen substance without suffering any adverse effect. If the effect ends while you are immersed in a solid, you die.

Pass without Trace

Level: Druid 1
 Range: Touch
 Duration: 1 hour

Using this spell, up to one creature per level can move through any type of terrain and leave neither footprints nor scent. Tracking the subjects is impossible by non-magical means.

Permanency

Level: Magic-User 5
 Range: See text
 Duration: Permanent; see text

This spell makes the effect of another spell permanent, unless a magic-user of twice the caster's level dispels it. No more than one permanency is ordinarily possible on any one object, and no more than two upon a creature. Considerable Treasure Keeper discretion is required for the use of this spell: Many spells should not be eligible to be made permanent. No temper-tantrums are permitted if the TK does not give you permission.

Permanent Illusion

Level: Magic-User 6
 Range: 240'
 Duration: Permanent

This spell functions like *phantasmal force*, except that the figment includes visual, auditory, olfactory and thermal elements, and the spell is permanent.

Persistent Illusion

Level: Magic-User 5
Range: 240'
Duration: 10 minutes

This spell functions like *phantasmal force*, except that the figment includes visual, auditory, olfactory and thermal components, and the figment follows a script determined by you. The figment follows that script without your having to concentrate on it. The illusion can include intelligible speech if you wish.

Phantasmal Force

Level: Magic-User 1
Range: 240'
Duration: Concentration

This spell creates the visual illusion of an object, creature, or force, as visualized by you. The illusion does not create sound, smell, texture, or temperature. You can move the image within the limits of the size of the effect.

Phantasmal Force II

Level: Magic-User 2
Range: 240'
Duration: Concentration + 2 rounds

This spell functions like *phantasmal force*, except it includes minor sounds but not understandable speech.

Phantasmal Killer

Level: Magic-User 4
Range: 120'
Duration: Instantaneous

You create a phantasmal image of the most fearsome creature imaginable to the subject. Only the spell's subject can see the *phantasmal killer*. The target first gets a saving throw to recognize the image as unreal. If it fails, the phantasm touches the subject and the subject must save or die from fear. Even if the save is successful, the subject takes 3d6 points of damage. If the subject succeeds in disbelieving and is wearing a *helm of telepathy*, the phantasm is turned back upon you. You must then disbelieve or become subject to its attack.

Phantom Steed

Level: Magic-User 3
Duration: 12 hours

You conjure a quasi-real horse-like creature. The steed can be ridden only by you or by the one person for whom

you created the mount. It has a saddle, bit and bridle. It does not fight, but animals shun it and refuse to attack it. A *phantom steed* has the stats of a light warhorse.

These mounts gain additional powers according to the caster's level. A mount's abilities include those of mounts of lower caster levels.

8th Level: The mount can ride over sandy, muddy, or swampy ground without difficulty or decrease in speed.

10th Level: The mount can use *water walk* at will.

12th Level: The mount can use *air walk* at will for up to 1 round at a time, after which it falls to the ground.

14th Level: The mount can *fly* at its normal land speed.

Phantom Trap

Level: Magic-User 2
Range: Touch
Duration: Permanent

This spell makes a lock or other small mechanism appear to be trapped to anyone who can detect traps.

Phase Door

Level: Magic-User 7
Range: Touch
Duration: One use per two levels

This spell creates an ethereal passage through wooden, plaster, or stone walls, but not other materials. The *phase door* is invisible and inaccessible to all creatures except the caster, and only the caster can use the passage. The caster disappears on entering the phase door and appears when exiting it. The caster can take one other creature (human-size or smaller) through the door. This counts as two uses of the door.

The door does not allow light, sound, or spell effects through it, nor can you see through it without using it. *Gems of true seeing* and similar magic reveal the presence of a *phase door* but do not allow its use.

A phase door can be made permanent with a *permanency* spell. You can allow other creatures to use the phase door by setting some triggering condition for the door. Such conditions can be as simple or elaborate as you desire. They can be based on a creature's name, identity, or alignment, but otherwise must be based on observable actions or qualities. Intangibles such as level, class, HD, and hit points do not qualify.

Planar Ally I

Level: Cleric 4

Range: 30'

Duration: Instantaneous

By casting this spell, you request your deity to send you an elemental or outsider of 6 HD or less of the deity's choice. If you know an individual creature's name, you may request them by speaking their name during the casting of the spell, though you might get a different creature anyway if your deity so desires.

You may ask the creature to perform one task in exchange for a payment from you. The creature requires a payment for its services. This can take a variety of forms, from donating gold or magic items to an allied temple, to a gift given directly to the creature, to some other action on your part that matches the creature's alignment and goals. This payment must be made before the creature agrees to perform any services.

Planar Ally II

Level: Cleric 6

Range: 30'

Duration: Instantaneous

As *planar ally I*, except you may call a single creature of 12 HD or less or two creatures of the same kind who's Hit Dice total no more than 12. The creatures agree to help you and request your return payment together.

Planar Ally III

Level: Cleric 8

Range: 30'

Duration: Instantaneous

As *planar ally I*, except that you may call a single creature of 18 HD or less, or up to three creatures of the same kind who's Hit Dice total no more than 18. The creatures agree to help you and request your payment together.

Planar Binding I

Level: Magic-User 5

Range: 30'

Duration: Instantaneous

Casting this spell is an attempt to lure a creature from another plane into a magic trap, which must lie within the spell's range. The called creature is held in the trap until it agrees to perform one service in return for its freedom. The kind of creature to be bound must be

known and stated. If you wish to call a specific individual, you must know their proper name.

If the target's saving throw fails, the creature is drawn to the trap (magic resistance does not keep it from being called). The creature can escape from the trap with dimensional travel or with a successful saving throw (subtracting half your caster level from the roll). If it breaks loose, it can flee or attack you. A *dimensional anchor* cast on the creature prevents its escape via dimensional travel.

If the creature does not break free of the trap, you can keep it bound for as long as you dare. You can attempt to compel the creature to perform a service by describing the service and perhaps offering some sort of reward. New offers, bribes, and the like can be made or the old ones reoffered every 24 hours.

Once the requested service is completed, the creature need only inform you to be instantly sent back whence it came. The creature might later seek revenge. If you assign some open-ended task that the creature cannot complete through its own actions the spell remains in effect for a maximum of one day per caster level, and the creature gains an immediate chance to break free. Note that a clever recipient can subvert some instructions.

Planar Binding II

Level: Magic-User 6

Range: 30'

Duration: Instantaneous

As *planar binding I*, except that you may call a single creature of 12 HD or less, or up to three creatures of the same kind who's Hit Dice total no more than 12. Each creature gets a save, makes an independent attempt to escape, and must be persuaded to aid you.

Planar Binding III

Level: Magic-User 8

Range: 30'

Duration: Instantaneous

As *planar binding I*, except that you may call a single creature of 18 HD or less, or up to three creatures of the same kind who's Hit Dice total no more than 18. Each creature gets a save, makes independent attempts to escape, and must be persuaded to aid you individually.

Plane Shift

Level: Cleric 5, Magic-User 7

Range: Touch

Duration: Instantaneous

You move yourself or some other creature to another plane of existence or alternate dimension. If several willing persons link hands in a circle, as many as eight can be affected by the plane shift at the same time. Precise accuracy as to a particular arrival location on the intended plane is nigh impossible. From the Material Plane, you can reach any other plane, though you appear 1d100 x 5 miles from your intended destination.

Plant Growth

Level: Druid 3

Range: See text

Duration: Instantaneous

This spell affects up to 300 square feet of ground. Undergrowth in the area grows into an impassable forest of thorns and vines. The caster can decide the shape of the area to be enchanted. This spell has no effect on plant creatures.

Poison

Level: Anti-Cleric 4, Druid 3

Range: Touch

Duration: Instantaneous; see text

You infect the subject with a lethal poison.

Polar Ray

Level: Magic-User 8

Range: 30'

Duration: Instantaneous

A blue ray of freezing air and ice bolts from your hand. The ray deals 1d6 points of cold damage per caster level.

Polymorph Any Object

Level: Magic-User 8

Range: 30'

Duration: TK's discretion

You can turn an object into something animal, vegetable, or mineral. The degree of change affects the spell's duration. Animal-to-animal, vegetable-to-vegetable and mineral-to-mineral changes are permanent until they are dispelled. Turning one type of substance into another lasts one turn per caster level.

Polymorph Other

Level: Druid 5, Magic-User 4

Range: 30'

Duration: Permanent

This spell allows the caster to turn another being into a different type of creature (such as a dragon, a garden slug, and of course, a frog or newt). The polymorphed creature gains all the abilities of the new form, but retains its own mind and hit points.

Polymorph Self

Level: Magic-User 4

Range: Personal

Duration: 1 hour

The caster assumes the form of any object or creature, gaining the new form's attributes (the use of wings, for example), but not its hit points or combat abilities. The TK might allow the benefit of the new form's armor class, if it is due to heavily armored skin. A great deal of the spell's effect is left to the Treasure Keeper to decide.

Power Word Blind

Level: Magic-User 7

Range: 30'

Duration: 1d4 or 2d4 days

The caster speaks a word of power to a target. If that target has fewer than 40 hit points, it is instantly blinded for 2d4 days. If the creature has from 41 to 80 hit points, it is blinded for 1d4 days. If it has more than 80 hit points it is not affected by the spell. No saving throw applies.

Power Word Kill

Level: Magic-User 9

Range: 30'

Duration: Instantaneous

The caster speaks a word of power to a particular target. If that target has fewer than 50 hit points, it is slain by the word it hears. If it has more than 50 hit points it is not affected by the spell. No saving throw is permitted.

Power Word Stun

Level: Magic-User 8

Range: 30'

Duration: 1d6 or 2d6 turns

The caster speaks a word of power to a particular target. If it has fewer than 35 hit points, it is stunned for 2d6 turns. If it has from 36 to 70 hit points, it is stunned for

1d6 turns. If it has more than 70 hit points it is not affected by the spell. No saving throw is permitted.

Prayer

Level: Cleric 3

Range: 40'

Duration: 1 round

Prayer affects a 20' radius area, imposing a saving throw penalty on all creatures in that area deemed an enemy to the caster. The penalty is equal to 1 + 1 per 10 caster levels. Thus, a 10th level cleric causes a saving throw penalty of -2. The penalty actually takes effect in the melee round following the one in which it was cast.

Precognition

Level: Magic-User 1

Range: Personal

Duration: 1 hour

Precognition allows your mind to glimpse fragments of potential future events. In essence, this gives you a +2 bonus that you can apply at any time to an attack roll, a damage roll, a saving throw, or a task check. You can elect to apply the bonus to the roll after you determine that your unmodified roll is lower than desired. Once you use this edge, it is gone.

Prestidigitation

Level: Magic-User 1

Range: 10'

Duration: 1 hour

Prestidigitations are minor tricks that novice spell casters use for practice. Once cast, you can perform simple magical effects for 1 hour. The effects are minor and have severe limitations. *Prestidigitation* can slowly lift 1 pound of material. It can color, clean, or soil items in a 1-foot cube each round. It can chill, warm, or flavor 1 pound of nonliving material. It cannot deal damage or affect the concentration of spell casters. *Prestidigitation* can create small objects, but they look crude and artificial. The materials created by a *prestidigitation* spell are extremely fragile, and they cannot be used as tools, weapons, or spell components. *Prestidigitation* lacks the power to duplicate any other spell effects. Any change to an object beyond moving, cleaning, or soiling it only lasts for 1 hour.

Prismatic Sphere

Level: Magic-User 9

Range: 10' radius sphere

Duration: 1 hour

A sphere of seven colors whirls about the caster. The glowing colors form a layered spectrum. To destroy the sphere, each layer must be destroyed in turn from Red to Orange, to Yellow, to Blue, to Indigo, and then to the innermost Violet layer. Any creature of 7 or fewer HD that looks upon the sphere is blinded for 1d6 turns.

Each color has the following effect:

Red: Stops magic arrows and missiles and deals 12 points of fire damage if touched. This layer is negated by *ice storm* or *cone of cold*.

Orange: Stops non-magical missiles and deals 24 points of acid damage if touched. This layer is negated by *lightning bolt*.

Yellow: Stops all breath weapons and deals 48 points of electricity damage if touched. This layer is negated by *magic missile* and magical missiles (arrows, bolts, etc.).

Green: Stops divination spells from seeing within and causes death if touched. This layer is negated by *passwall* or the *move earth* spell.

Blue: Stops divine magic and turns flesh to stone when touched. This layer is negated by *disintegrate*.

Indigo: Stops magic-user spells and causes permanent madness. This layer is negated by *continual light*.

Violet: Destroys all objects and magic effects and sends creatures to a random plane. Negated by *dispel magic*.

Prismatic Spray

Level: Magic-User 7

Range: 60'

Duration: Instantaneous

The excellent *prismatic spray* spell causes seven shimmering, intertwined, multicolored beams of light to spray from your hand. Each beam has a different power. Creatures in the area of the spell with 8 HD or less are blinded for 2d4 rounds (no save). Every creature in the area is randomly struck by one or more beams, which have the following additional effects.

d8	Effect
1	Red: 12 points fire damage
2	Orange: 24 points acid damage
3	Yellow: 48 points electricity damage
4	Green: Poison (Kills; successful save means you only take 3d6 points of damage)
5	Blue: Turned to stone
6	Indigo: As <i>insanity</i> spell
7	Violet: Sent to another plane
8	Struck by two rays; roll twice more, ignoring any "8" results.

Prismatic Wall

Level: Magic-User 8

Range: 30'

Duration: 1 hour

You create a vertical, opaque wall of multicolored light that protects you from all forms of attack. The wall flashes with seven colors, each of which has a distinct power and purpose. The wall is immobile, and you can pass through and remain near the wall without harm. However, any other creature with less than 7 HD that is within 20 feet of the wall is blinded for 2d4 rounds by the colors if it looks at the wall. The wall's maximum proportions are 4 feet wide per caster level and 2 feet high per caster level.

Each color in the wall has a special effect as in the spell *prismatic sphere* above. The colors appear in the same order and can be disrupted in the same way.

Probe Thoughts

Level: Magic-User 6

Range: 30'

Duration: Concentration

All the subject's memories and knowledge are accessible to you. You can learn the answer to one question per round, to the best of the subject's knowledge. You and the target do not need to speak the same language, though less intelligent creatures may yield up only appropriate visual images in answer to your questions.

Produce Flame

Level: Druid 1

Range: 0'

Duration: 1 hour

A flame as bright as a torch appears in your open hand. The flames harm neither you nor your equipment. They can be hurled up to 120' or used to touch enemies, dealing 1d6 +1 point per caster level damage.

Programmed Illusion

Level: Magic-User 6

Range: 240'

Duration: Permanent until triggered, then 1 minute

This spell functions like *spectral force*, except that it activates when a specific condition occurs.

Project Image

Level: Magic-User 7

Range: 240'

Duration: 1 hour

The caster projects his image up to 240' away. The projected image not only mimics the caster's sounds and gestures, but also any spells he casts appear to originate from the image.

Protection from Energy

Level: Druid 3, Magic-User 3

Range: Touch

Duration: 1 hour or until discharged

Protection from energy grants temporary immunity to the type of energy you specify when you cast it (acid, cold, electricity, fire, or sonic). Once the spell has absorbed 10 points per caster level of damage, it ends.



Protection from Evil/Good

Level: Cleric 1, Magic-User 1

Range: Touch

Duration: 1 hour for magic-users, 2 hours for clerics

This spell creates a magical field of protection around the caster, blocking out all elementals and outsiders. Chaotic monsters suffer a -1 penalty to attack the caster, and the caster gains +1 on all saving throws against attacks and spells from such creatures. If the caster already has any magical bonuses to his saving throws or AC, the bonus

from the spell has no effect, although it still functions against elementals and outsiders.

The reverse functions like *protection from evil*, except that it works against Lawful instead of Chaotic monsters.

Protection from Evil/Good II

Level: Cleric 3, Magic-User 3

Range: Touch

Duration: 1 hour

As *protection from evil* or *protection from good*, but affecting a 10' radius around the subject of the spell.

Protection from Arrows

Level: Magic-User 2

Range: Touch

Duration: 2 hours

The subject is invulnerable to non-magical missiles, although large missiles like boulders overcome the spell.

Protection from Spells

Level: Magic-User 8

Range: Touch

Duration: 1 hour

The subject gains a +8 bonus on saving throws against spells. If a subject loses the spell focus, the spell ends.

Focus: Diamond (1,000 gp) carried by each subject for the duration of the spell

Prying Eyes

Level: Magic-User 5

Range: One mile

Duration: 12 hours

You create a number of semi-tangible, visible magical orbs (called "eyes") equal to 1d4 + your caster level. These eyes move out, scout around, and return as you direct them when casting the spell. Each eye can see 120 feet (normal vision only) in all directions. In order to report their findings, the eyes must return to your hand. Each replays in your mind all it has seen during its existence. After relaying its findings, an eye disappears.

Psionic Blast

Level: Magic-User 3

Area: 30' cone

Duration: Instantaneous

The air ripples with the force of your mental attack, which blasts the minds of all creatures in the area of effect, stunning them for 1 round.

Psychic Crush

Level: Magic-User 5

Range: 30'

Duration: Instantaneous

Your will crushes the mental essence of any one creature. The target must make a saving throw with a +4 bonus or collapse unconscious at 0 hit points. Even if the target succeeds on the save, it takes 3d6 points of damage.

Purify Food and Drink

Level: Cleric 1, Druid 1

Range: 10'

Duration: Instantaneous

Enough food and water for up to 12 people is made pure, removing spoilage and poisons.

Pyrotechnics

Level: Druid 3, Magic-User 2

Range: 240'

Duration: 1 hour

The caster creates fireworks or blinding smoke from a normal fire such as a torch or campfire. The TK decides exactly how much smoke is produced, what effect it has, and what happens to it as it's produced.

Quench

Level: Druid 3

Range: 120'

Duration: Instantaneous

You extinguish all non-magical fires in a 60' diameter area. Each fire elemental creature within the spell's area of effect takes 1d6 points of damage per caster level.

Quest

Level: Cleric 6

Range: Sound of voice

Duration: Until completed

The caster may set a task for the spell's target. If the victim does not diligently work at performing the task, he suffers weakness (a 50% reduction in strength) and an attempt to entirely abandon the quest incurs a curse set by the caster (details to be approved by the TK).

Rage

Level: Magic-User 3

Range: 120'

Duration: 1 minute

One willing creature per three levels enters a berserk fury, making one additional attack per round.

Rainbow Pattern

Level: Magic-User 4

Range: 120'

Duration: Concentration +1 round/ level

A glowing, rainbow-hued pattern of interweaving colors fascinates (as a bard) those within it. The pattern covers a 20' radius area around a point designated by the caster within 150 feet. *Rainbow pattern* fascinates a maximum of 24 Hit Dice of creatures. Creatures with the fewest HD are affected first. An affected creature that fails its saves is fascinated by the pattern. The *rainbow pattern* can be moved up to 30' per round by the caster. All fascinated creatures follow the moving rainbow of light, trying to get or remain within the effect. If the pattern leads its subjects into a dangerous area each fascinated creature gets a second save. Creatures that cannot see the pattern are no longer affected by the spell.

Raise Dead

Level: Cleric 5

Range: Touch

Duration: Instantaneous

Raise dead allows the cleric to raise a corpse from the dead, provided it has not been dead too long. The normal time limit is 5 days, but for every caster level above 8th, the time limit extends another 5 days. Characters that fail a system shock test (see below) do not survive the ordeal, and those that do must still rest for at least a week before they can function normally.

A system shock test requires the player to roll 1d20 under their character's constitution score.

Random Action

Level: Cleric 1

Range: 30'

Duration: 1 round

The enchanted creature is compelled to act randomly for 1 round. Rather than deciding its action for itself, the subject of the spell takes an action determined randomly on the following table:

d8	Action
1	Attack self (succeed on any attack roll of 2 or higher)
2	Attack nearest being
3	Flee from caster at top possible speed
4	Drop anything held
5	Stand motionless (as if stunned)
6	Do nothing but defend
7	Speak your surface thoughts or make noises
8	Attack caster

Nothing can affect this die roll in any way. It is always entirely random.

Ray of Enfeeblement

Level: Magic-User 1

Range: 30'

Duration: 1 minute

A coruscating ray springs from your hand at any target within range. The subject's strength score is reduced to 3. In the case of monsters, they fight as though they had 4 fewer Hit Dice (minimum 0 HD).

Ray of Fatigue

Level: Magic-User 3

Range: 30'

Duration: 10 minutes

A black ray projects from your pointing finger to any target within 30 feet. If struck, the subject is fatigued.

Ray of Frost

Level: Magic-User 1

Range: 30'

Duration: Instantaneous

A ray of freezing air and ice projects from your pointing finger at a target within range. The ray deals 1d6 points of cold damage.

Read Magic

Level: Magic-User 1

Range: Personal

Duration: 2 scrolls or other magical writings

This spell allows the caster to read magical writing, including on scrolls and in spellbooks.

Reduce Animal

Level: Druid 2

Range: Touch

Duration: 1 hour

This spell functions like *reduce person*, except that it affects a single willing animal. Reduce the damage dealt by the animal's natural attacks by -1.

Reduce Person

Level: Magic-User 1

Range: 30'

Duration: 1 minute

This spell causes instant diminution of a humanoid creature, halving its height, length, and width and dividing its weight by 8. This decrease changes the creature's size category to the next smaller one. The target gains a -2 penalty to strength (to a minimum of 1). All equipment worn or carried by a creature is similarly reduced by the spell. Any reduced item that leaves the reduced creature's possession (including a projectile or thrown weapon) instantly returns to its normal size.

Reflect Gaze

Level: Magic-User 1

Range: 120'

Duration: 1 round

This spell reflects gaze attacks back at monsters.

Refuge

Level: Cleric 7, Magic-User 9

Range: Touch

Duration: Permanent until discharged

You imbue a specially prepared object with magic. The object contains the power to instantly transport its possessor across any distance within the same plane to your abode. Once the item is transmuted, you must give it to a creature and at the same time inform it of a command word to be spoken when the item is used. To make use of the item, the subject speaks the command word at the same time that it rends or breaks the item. When this is done, the individual is instantly transported to your abode. No other creatures are affected. You can alter the spell when casting it so that it transports you to within 10 feet of the possessor of the item when it is broken and the command word is spoken.

Component: Specially prepared object whose construction requires gems worth at least 1,500 gp.

Regenerate

Level: Cleric 7, Druid 9

Range: Touch

Duration: Instantaneous

The subject's severed members (fingers, toes, hands, feet, arms, legs, tails, and even heads of multi-headed creatures), broken bones and ruined organs grow back. The physical regeneration is complete in 1 round if the severed members are present and touching the creature. It takes 2d10 rounds otherwise. Regenerate also cures 4d8 points of damage and rids the subject of fatigue. It has no effect on nonliving creatures, including undead.

Reincarnate

Level: Druid 6, Magic-User 6

Range: Touch

Duration: Instantaneous

This spell brings a dead character's soul back from the dead, but the soul reappears in a newly formed body. If the resulting creature is a normal character race, roll 1d6 to determine the character's new level.

Roll	Reincarnated as ...	Roll	Reincarnated as ...
1	Bugbear	11	Human
2	Centaur	12	Kobold
3	Dog or Cat	13	Lizard man
4	Dwarf	14	Lycanthrope
5	Elf	15	Minotaur
6	Gnoll	16	Ogre
7	Goblin	17	Ogre Mage
8	Half-orc	18	Orc
9	Harpy	19	Troll
10	Hobgoblin	20	Wyvern

Remove Curse

Level: Cleric 3, Magic-User 4

Range: Touch

Duration: Instantaneous

This spell removes a curse from a person or object.

Remove Fear

Level: Cleric 1

Range: 30'

Duration: 10 minutes; see text

You instill courage in the subject, granting it a +2 bonus against fear effects for 10 minutes. If the subject is under

the influence of a fear effect when receiving the spell, that effect is suppressed for the duration of the spell.

Remove Paralysis

Level: Cleric 2
Range: 30'
Duration: Instantaneous

You can free up to four creatures from paralysis.

Repel Metal or Stone

Level: Druid 8
Range: 60'
Duration: 1 hour

As *repel wood*, except that it repels metal and stone.

Repel Vermin

Level: Druid 4
Range: 10'
Duration: 1 hour

An invisible barrier 10' in radius holds back vermin. A vermin with Hit Dice equal to or less than one-third your level cannot penetrate the barrier. A vermin with Hit Dice of one-third your level or more can penetrate the barrier if it succeeds on a saving throw. Even so, crossing the barrier deals the vermin 2d6 points of damage, and pressing against the barrier causes pain.

Repel Wood

Level: Druid 6
Range: 60'
Duration: 1 hour

Waves of energy roll forth from you in a 60' line, moving in the direction that you determine, causing all wooden objects in the path of the spell to be pushed away from you to the limit of the range. Wooden objects that are fixed firmly are not affected, but loose objects are. Objects affected by the spell are repelled at the rate of 40' per round. Objects that are carried drag those carrying them along. The waves of energy continue to sweep down the set path for the spell's duration. After you cast the spell, the path is set, and you can then do other things or go elsewhere.

Repulsion

Level: Magic-User 6
Range: 120'
Duration: 1 hour

Any creature within the spell's range trying to move toward the caster finds itself moving away, instead.

Resilient Sphere

Level: Magic-User 4
Range: 30'
Duration: 10 minutes

A globe of shimmering force 1' in diameter per level encloses a creature, provided they fit within the sphere. The sphere is not subject to damage of any sort except from a *rod of cancellation*, *rod of negation*, *disintegrate* spell or *dispel magic*. These effects destroy the sphere without harm to the subject. Nothing can pass through the sphere, inside or out, though the subject can breathe normally. The subject may struggle, but the sphere cannot be physically moved.

Resistance

Level: Magic-User 1
Range: Touch
Duration: 1 hour

You imbue the subject with magical energy that protects it from harm, granting it a +1 bonus on saves.

Resist Energy

Level: Cleric 2, Druid 2, Magic-User 2
Range: Touch
Duration: 1 hour

You grant a creature limited protection from damage of an energy type you select: Acid, cold, electricity, fire, or sonic. The subject suffers half normal damage from the energy type chosen. Resist energy only absorbs damage; the subject can still suffer unfortunate side effects.

Restoration

Level: Cleric 4
Range: Touch
Duration: Instantaneous

You restore lost levels and ability points. Casting the spell is exhausting, incapacitating the caster for 2d10 days.

Resurrection

Level: Cleric 7
Range: Touch
Duration: Instantaneous

This spell raises the dead back to life. The person raised from the dead needs no time to recuperate from the experience of death and suffers no other penalties.

Component: Holy water

Reverse Gravity

Level: Druid 8, Magic-User 7

Range: 120'

Duration: 1 minute

The spell reverses gravity in an area 30' long x 30' wide x 30' high in size. Anything in the area falls upward until the spell ends, when they fall back down again.

Righteous Might

Level: Cleric 5

Range: Personal

Duration: 1 minute

Your height doubles (per *enlarge person*), you gain a +2 bonus to your AC and can only be hit by magic weapons.

Rope Trick

Level: Magic-User 2

Range: Touch

Duration: 1 hour + 1 turn/level

The caster tosses a rope into the air, and it hangs there, waiting to be climbed. The caster and up to three others can climb the rope and disappear into a small pocket dimension. The rope itself can be pulled into the pocket dimension, or left outside. If it's left outside, someone may steal it.

Rusting Grasp

Level: Druid 4

Range: Touch

Duration: 1 round/level

Any iron or iron alloy item you touch is rusted and destroyed immediately. If the item is so large that it cannot fit within 3 cubic feet, then a 3-cubic foot portion is rusted and destroyed. Magic items made of metal are immune to this spell. Against a ferrous creature, *rusting grasp* deals 3d6 points of damage per successful attack. The spell lasts for 1 round per level and you can make one *rusting grasp* attack per round.

Sanctuary

Level: Cleric 1

Range: Touch

Duration: 1 minute



Any opponent attempting to attack the warded creature, even with a targeted spell, must attempt a saving throw. If the save fails, the opponent cannot follow through with the attack and loses its turn. This spell does not prevent the warded creature from being attacked by or affected by area effect spells. The subject cannot attack without breaking the spell.

Scare

Level: Magic-User 2

Range: 120'

Duration: As *cause fear*

This spell functions like *cause fear*, except that it effects up to one creature per three caster levels that have fewer than 6 HD to become frightened.

Scintillating Pattern

Level: Magic-User 8

Range: 30'

Duration: Concentration + 2 rounds

A twisting pattern of colors weaves through the air, affecting creatures within it. The pattern covers a 20' radius area. The spell affects a total number of Hit Dice of creatures equal to your caster level. Creatures with the fewest HD are affected first. The spell affects each subject according to its Hit Dice. Creatures with 6 HD or less are knocked unconscious for 1d4 rounds. Creatures with 7 to 12 HD are stunned for 1d4 rounds. Creatures with 13 or more HD are *confused* for 1d4 rounds.

Scorching Ray

Level: Magic-User 2

Range: 30'

Duration: Instantaneous

You blast your enemies with fiery rays. You may fire one ray for every five levels you have beyond 3rd. Each ray deals 4d6 points of fire damage. The rays may be fired at the same or different targets, but all bolts must be aimed at targets within 30 feet of each other and fired simultaneously.

Scourge

Level: Cleric 7
 Range: 30 miles
 Duration: Permanent

Scourge is used to punish heretics and criminals that might otherwise escape the law. The caster must know the name of the target of the spell to target them.

When the spell is cast, pick one of the following effects:

- Age: The victim ages one year each day.
- Barren Touch: Food and drink touched by the victim spoils, plants he tills die and *cure* spells he casts have a 50% chance of becoming *inflict* spells of the same level.
- Ignominy: Anyone who comes into contact with the target forgets any valorous deeds she has done, while clearly remembering any crimes she has committed. People attribute the character’s greatest achievements to other people. If the curse is lifted, the memories return.
- Ostracism: The victim is surrounded by an aura that causes NPCs to have a hostile attitude towards him. Any sort of spell used to detect alignment always responds with the alignment most hostile to the caster, and *discern lies* always shows that the victim as lying.
- Poverty: Precious metal the victim touches turns to lead.
- Prohibition: You specify a specific action that the victim cannot take. ‘Do not lie’ or ‘Do not physically hurt humans’ works, but impossible or broad requests like ‘Do not breathe’ or ‘Never hurt anyone in any way’ do not. The target must succeed at a saving throw to perform the prohibited act. If he fails, he is sickened and

stunned for 2d4 rounds.

Remove curse ends the curse if the caster is 2 or more levels above yours. *Miracle* and *wish* also work. The caster can also apply a condition that lifts the curse.

Screen

Level: Magic-User 8
 Range: 30’
 Duration: 24 hours

When you cast *screen*, you dictate what can and cannot be observed in the spell’s area of effect of 30 cubic feet per caster level. The type of illusion that fills the area must be stated in general terms. Once the conditions are set, they cannot be changed. Attempts to scry the area detect the image stated by you with no save allowed. Sight and sound are appropriate to the illusion created.

Scrying

Level: Cleric 5, Druid 4, Magic-User 4
 Range: See text
 Duration: 10 minutes

You can see and hear a creature, which may be any distance away. If the subject succeeds on a saving throw the scrying attempt fails. The difficulty of the save depends on how well you know the subject (from -5 for knowing the subject well to +10 for having no knowledge of them at all) and what sort of physical connection you have to that creature.

Connection	Penalty
Likeness or picture	-2
Possession or garment	-4
Body part, lock of hair, bit of nail, etc.	-10

If the save fails, you can see and hear the subject and the subject’s immediate surroundings. The following spells have a 5% chance per caster level of operating through the sensor: *Detect evil*, *detect magic* and *message*.

Focus: Magic-users need a mirror worth 1,000 gp, clerics a holy water font worth 100 gp, druids a natural pool of water

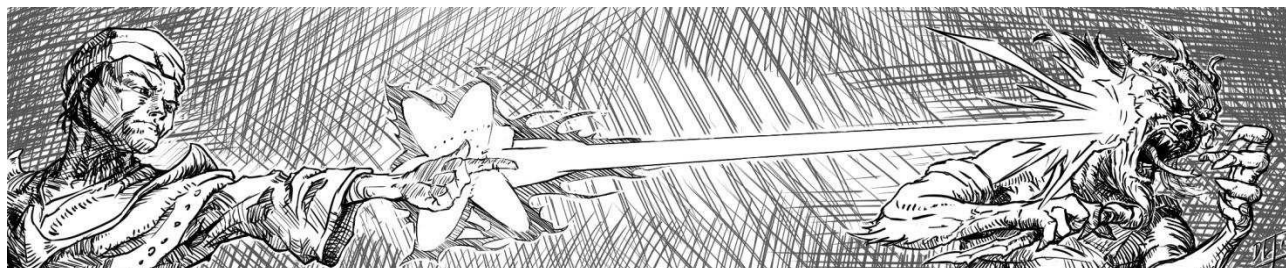

Searing Light

Level: Cleric 3

Range: 120'

Duration: Instantaneous

You project a ray of light at a single target within range. A creature struck by this ray of light takes 1d4 points of damage per caster level. An undead creature takes 1d6 points of damage per caster level and an undead creature particularly vulnerable to bright light takes 1d8 points of damage per caster level. A construct or inanimate object takes only 1d3 points of damage per two caster levels.

Secret Chest

Level: Magic-User 5

Range: See text

Duration: Sixty days or until discharged

You hide a chest on the Ethereal Plane for as long as 60 days and can retrieve it at will. If any living creatures are in the chest, there is a 75% chance that the spell fails. Once the chest is hidden, you can retrieve it by concentrating and it appears next to you.

The chest must be expensive and constructed for you by master crafters. The cost of such a chest is never less than 5,000 gp. Once it is constructed, you must make a tiny replica of the chest that costs 50 gp. You can have but one pair of these chests at any given time. The chests are non-magical and can be fitted with locks, wards, and so on, just as any normal chest can be.

After 60 days on the Ethereal Plane, there is a cumulative chance of 5% per day that the chest is irretrievably lost. If the miniature of the chest is lost or destroyed, there is absolutely no way that the large chest can be summoned back, although an extra-planar expedition might be mounted to find it.

Secret Page

Level: Magic-User 3

Range: Touch

Duration: Permanent

Secret page alters the contents of a page so that they appear to be something entirely different.

Component: Essence of will-o'-wisp

Secure Shelter

Level: Magic-User 4

Range: 30'

Duration: 2 hours/level

You conjure a sturdy cottage or lodge made of material common in the area where the spell is cast. The door, shutters, and even chimney are secure against intrusion, the former two being *wizard locked* and the latter secured by an iron grate at the top and a narrow flue. In addition, these three areas are protected by an *alarm* spell. Finally, an *unseen servant* is conjured to provide service to you for the duration of the shelter. The secure shelter contains rude furnishings: Eight bunks, a trestle table, eight stools, and a writing desk.

Seeming

Level: Magic-User 5

Range: 30'

Duration: 12 hours

As *change self*, except that you can change the appearance of up to one other person per two levels. Creatures resume their normal appearance if slain.

Sending

Level: Magic-User 5

Range: See text

Duration: Instantaneous

You contact a particular creature with which you are familiar and send them a short message of 25 words or less. The subject recognizes you if it knows you. It can answer in like manner immediately.

Sepia Snake Sigil

Level: Magic-User 3

Range: Touch

Duration: See text

When you cast *sepia snake sigil*, a small symbol appears in the text of one written work such as a book, scroll, or map. The text containing the symbol must be at least 25 words long. When anyone reads the text containing the symbol, the sepia snake springs into being and strikes the reader, provided there is line of effect between the symbol and the reader.

The target is entitled to a saving throw to evade the snake's strike. If it succeeds, the sepia snake dissipates in a flash of brown light accompanied by a puff of dun-colored smoke and a loud noise. If the target fails its save, it is engulfed in a amber field of force and immobilized until released, either at your command or when 1d4 days + one day per caster level have elapsed.

While trapped in the field of force, the subject does not age, breathe, grow hungry, sleep, or regain spells. It is preserved in a state of suspended animation, unaware of its surroundings. It can be damaged by outside forces (and perhaps even killed), since the field provides no protection against physical injury.

Component: Amber powder (500 gp)

Sequester

Level: Magic-User 7
Range: Touch
Duration: 13 days

When cast, this spell not only prevents divination spells from working to detect or locate the creature or object affected by *sequester*, it also renders the affected creature or object invisible. The spell does not prevent the subject from being discovered through the use of devices. Creatures affected by *sequester* become comatose and are effectively in a state of suspended animation until the spell wears off or is dispelled.

Component: Basilisk eyelash (basilisks have 600 lashes)

Shades

Level: Magic-User 9
Range: See text
Duration: See text

This spell functions like *shadow conjuration*, except that it mimics magic-user conjuration spells of 8th level or lower. The illusory conjurations created deal four-fifths (80%) damage to non-believers, and other effects are 80% likely to work against non-believers.

Shadow Conjuration I

Level: Magic-User 4
Range: See text
Duration: See text

This spell creates quasi-real monsters from shadows with Hit Dice no higher than the caster's level. Targets of these monsters must pass a saving throw against the illusion. If they succeed, the monsters attack with the caster's attack bonus, have 20% of a real monsters hit points, Armor Class 10, deal 1 point of damage with each hit and have none of the monster's special abilities. If the save vs. illusion is failed, the monsters attack as though they were completely real.

Shadow Conjuration II

Level: Magic-User 7
Range: See text
Duration: See text

As *shadow conjuration I*, except that the monsters are 60% real to non-believers, have AC 15 and the caster can create a monster with twice the Hit Dice as he has levels.

Shadow Evocation I

Level: Magic-User 5
Range: See text
Duration: See text

You can use this spell to create quasi-real evocation spells of 4th level or lower. Targets that fail a saving throw are affected as though the spell was completely real. Targets that pass a save vs. illusion take only 20% of normal damage from the attack. If the disbelieved attack has a special effect other than damage, that effect is one-fifth as strong (if applicable) or only 20% likely to occur.

Shadow Evocation II

Level: Magic-User 8
Range: See text
Duration: See text

As *shadow evocation I*, except that it enables you to create illusory versions of evocation spells of 7th level or lower, and those spells are three-fifths (60%) real to non-believers.

Shadow Walk

Level: Magic-User 6
Range: Touch
Duration: 12 hours

To use *shadow walk* you must be in an area of shadows. You and any creature you touch are then transported to the edge of the Material Plane where it borders the Plane of Shadow. The effect is largely illusory, but the path is quasi-real. You can take more than one creature per level along with you, but all must be touching each other.

In the region of shadow, you move at a rate of 50 miles per hour, moving normally in the Plane of Shadow but much more rapidly relative to the Material Plane. Thus, you can use this spell to travel rapidly by stepping onto the Plane of Shadow, moving the desired distance, and then stepping back onto the Material Plane. Because of the blurring of reality between the Shadow Plane and the Material Plane, you cannot make out details of the terrain

or areas you pass over during transit, nor can you predict perfectly where your travel will end.

Shadow walk can also be used to travel to other planes that border on the Plane of Shadow, but this usage requires the transit of the Plane of Shadow to arrive at a border with another plane of reality. The transit of the Plane of Shadow requires 1d4 hours and the caster and her party may be subject to wandering monsters.

Shambler

Level: Druid 9

Range: 120'

Duration: Seven days or months; see text

This spell creates 1d4+2 shambling mounds (see Monster book). The creatures aid you in combat, perform a specific mission, or serve as bodyguards. They remain with you for seven days unless you dismiss them. If the shamblers are created only for guard duty the duration of the spell is seven months. Shamblers summoned to guard duty cannot move outside the spell's range, which is measured from the point where each first appeared.

Shapechange

Level: Druid 9, Magic-User 9

Range: Personal

Duration: 1d6 + 10 turns + 1 turn per level

The caster can turn into any other creature at will. In each form, he gains the characteristics of the creature. Thus, turning into a dragon allows the caster to use the dragon's breath weapon. The caster might then choose to turn into a raven, then a frog, and whatever other creatures he might choose. It is not, of course, required that the caster use more than one shape—if he may remain in one form for the duration of the spell.

Focus: Jade circlet (1,500 gp) worn on head

Shatter

Level: Magic-User 2

Range: 30'

Duration: Instantaneous

Shatter creates a loud, ringing noise that breaks brittle, non-magical objects up to 1 lb. in weight in a 5' radius, sunders a single solid, non-magical object up to 10 lb. per caster level, or inflicts 1d6 points of damage per level to a crystalline creature.

Shield

Level: Magic-User 1

Range: Personal

Duration: 2 turns

You materialize an invisible shield that blocks attacks. It gives you AC 17 against missile attacks and AC 15 against melee attacks. If your Armor Class is already better than the spell would grant, the spell has no effect.

Shield of Faith

Level: Cleric 1

Range: Touch

Duration: 1 minute

This spell creates a shimmering, magical field around the touched creature grants the subject a +2 bonus to AC.

Shield Other

Level: Cleric 2

Range: 30'

Duration: 1 hour

This spell wards the subject and creates a mystic connection between you and the subject. The subject gains a +1 bonus to AC and to saving throws. In addition, the subject takes only half damage from attacks that deal hit point damage. The amount of damage not taken by the warded creature is taken by you.

Focus: Two platinum rings (50 gp), worn by you and subject

Shillelagh

Level: Druid 1

Range: Touch

Duration: 1 minute

Your own non-magical club or staff becomes a weapon with a +1 magic bonus on attack and damage rolls.

Shocking Grasp

Level: Magic-User 1

Range: Touch

Duration: Instantaneous

A successful melee attack, which ignores armor, deals 1d6 points of electricity damage per caster level. When delivering the jolt, you gain a +3 bonus to attack if the opponent is wearing metal armor.

Shockwave

Level: Magic-User 3
Range: 120'
Duration: Instantaneous

This spell causes a 20' radius wave of force to explode outward from a point designated by the caster. The wave deals 3d6 points of damage to all creatures within its area of effect, and knocks those who fail a saving throw back 1d6 x 3 feet. Flying creatures take only half damage from the wave and are not knocked prone, but are knocked back 1d6 x 3 feet. There is a 5 foot hole in the center of this effect's radius, so you may target yourself or an ally with this spell with no adverse effects.

Shout

Level: Magic-User 4
Area: 30' cone
Duration: Instantaneous

You emit an ear-splitting yell that deafens and damages creatures in its path. Any creature within the area is deafened for 2d6 rounds and takes 5d6 points of sonic damage. A successful saving throw negates the deafness and reduces the damage by half. Any exposed brittle or crystalline object or crystalline creature takes 1d6 points of sonic damage per level.

Shrink Item

Level: Magic-User 3
Range: Touch
Duration: One day/level; see text

You are able to shrink one non-magical item you can lift to 1/16 of its normal size in each dimension. Objects changed by *shrink item* can be returned to normal composition and size merely by tossing them onto any solid surface or by a word of command from the caster. It can even shrink a burning fire and its fuel.

Silence

Level: Cleric 2
Range: 120'
Duration: 2 hours

Magical silence is cast on a creature or object. It cancels all sound within 15' of that creature or object.

Simulacrum

Level: Magic-User 7
Range: 0'
Duration: Instantaneous

You create a duplicate of yourself or another person. The basic form is created from snow and ice, and must then be animated (*animate dead* is an acceptable means). A *limited wish* along with the *simulacrum* spell is then used to imbue the animated form with intelligence and 30–60% (1d3 x 10) of the simulated creature's knowledge and experience. The simulacrum follows its creator's orders. It is worthy of note that the simulacrum is not a perfect representation of the original. Side by side, the differences are obvious, and the simulacrum is a magical creature detectable with *detect magic*. If the original of the simulacrum dies, the simulacrum begins to gain the knowledge and experience of the dead individual at a rate of 1% per week (to a maximum of 90%).

Component: Pieces of the creature that is to be duplicated must be put into the snow or ice

Slay Living

Level: Cleric 5
Range: Touch
Duration: Instantaneous

You can slay a single living creature. You must succeed on a melee attack which ignores armor to touch the subject, and they can avoid death with a saving throw. Even if it succeeds, the target takes 3d6 damage.

Sleep

Level: Magic-User 1
Range: 120'
Duration: 1 hour

This spell puts 2d6 Hit Dice worth of enemies into an enchanted slumber (no saving throw permitted). The sleeping creatures can be awakened with vigorous shaking, but otherwise slumber for 1 hour.

Sleep II

Level: Magic-User 3
Range: 30'
Duration: 1 hour

This spell functions like *sleep* except that it affects 10 HD worth of creatures.

Sleet Storm

Level: Druid 3, Magic-User 3

Range: 240'

Duration: 1 minute

This spell creates driving sleet in a cylindrical area 40' in radius and 20' high. This sleet blocks all sight within it and causes the ground to be icy. A creature can walk within or through the area of sleet at half normal speed with a saving throw. Failure means it cannot move in that round, while failure by 5 or more means it falls. The sleet extinguishes small fires.

Slow

Level: Magic-User 3

Range: 120'

Duration: 30 minutes

In a 60' radius area around the point where the spell is targeted, as many as 24 creatures failing a saving throw move at half speed and attack every other round.

Smite

Level: Cleric 4

Range: 120'

Duration: Instantaneous (1 round); see text

You draw down divine power to smite your enemies in a 20' radius burst. The spell deals 1d8 points of damage per two caster levels to each creature of opposite alignment (i.e. Lawful cleric smite Chaotic creatures, Chaotic anti-clerics smite Lawful creatures) in the area (or 1d6 points of damage per caster level to outsiders) and causes it to become *blinded* for 1 round. A successful saving throw reduces damage to half and negates the blinded effect. The spell deals only half damage to Neutral creatures, and they are not blinded.

Smoke Image

Level: Magic-User 1

Range: 30'

Duration: Concentration

This spell shapes existing smoke into any shape the spellcaster can visualize. The image is composed entirely of smoke and, if disturbed by any force or action, dissipates back into smoke.

Snare

Level: Druid 3

Range: Touch

Duration: Until triggered or broken

You make a snare that functions as a magic trap. The snare can be made from any supple vine, thong or rope. When you cast *snare* on it, the object blends with its surroundings. One end of the snare is tied in a loop that contracts around one or more of the limbs of any creature stepping inside the circle. If a strong and supple tree is nearby, the snare can be fastened to it. The spell causes the tree to bend and then straighten when the loop is triggered, dealing 1d6 points of damage to the creature and lifting it off the ground by the trapped limb or limbs. If no such tree is available, the cordlike object tightens around the creature, dealing no damage but causing it to be entangled.

Soften Earth and Stone

Level: Druid 2

Range: 30'

Duration: Instantaneous

When this spell is cast, all natural, undressed earth or stone in the spell's area is softened. Wet earth becomes thick mud, dry earth becomes loose sand or dirt, and stone becomes soft clay that is easily molded or chopped. You affect a 10 square foot area to a depth of 1 to 4 feet, depending on the toughness or resilience of the ground at that spot. Magical, enchanted, dressed or worked stone cannot be affected. Earth elementals and creatures made of stone are not affected.

Solid Fog

Level: Magic-User 4

Range: 120'

Duration: 10 minutes

This spell functions like *fog cloud*, but in addition to obscuring sight the fog is so thick that any creature attempting to move through it progresses at a speed of 5' per round, regardless of its normal speed, and it takes a -2 penalty on all melee attack and damage rolls. The vapors prevent ranged weapon attacks except for magic rays and the like. A creature or object that falls into solid fog is slowed, so that each 10' of vapor that it passes through reduces falling damage by 1d6. Unlike normal fog, only a strong wind disperses these vapors.

Soul Bind

Level: Cleric 9, Magic-User 9

Range: 30'

Duration: Permanent

You draw the soul from a newly dead body and imprison it in a black sapphire. The subject must have been dead no more than 1 round per caster level. The soul, once trapped in the gem, cannot be returned through *clone*, *raise dead*, *reincarnate*, *resurrection*, *true resurrection*, *miracle* or *wish*. Only by destroying the gem or dispelling the spell can one free the soul.

Component: Black sapphire worth 1,000 gp per HD of creature whose soul is to be bound

Sound Burst

Level: Cleric 3

Range: 30'

Duration: Instantaneous

You blast an area with a terrible cacophony. Every creature in a 10' radius area takes 1d8 points of sonic damage and must succeed on a saving throw to avoid being stunned for 1 round.

Speak with Animals

Level: Cleric 2, Druid 1

Range: Personal

Duration: 1 hour

You can understand and speak the language of animals.

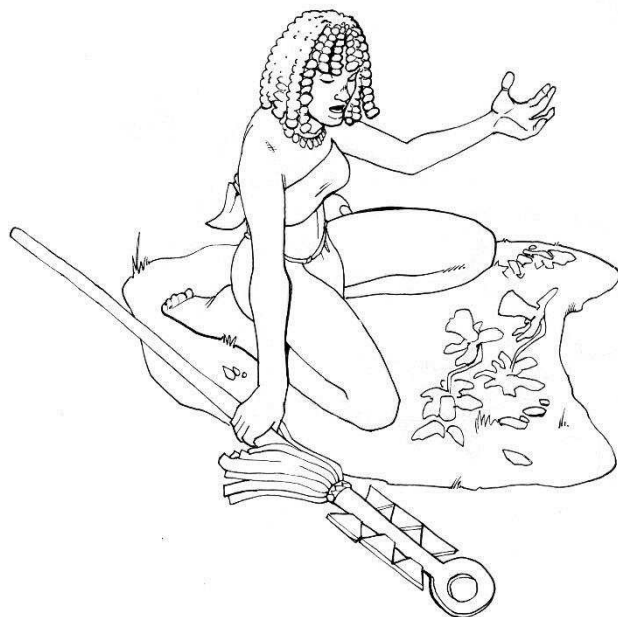

Speak with Dead

Level: Cleric 3

Range: 10'

Duration: 3 questions

The caster can ask three questions to a corpse and it answers, although the answers might be cryptic. Clerics lower than 8th level can only gain answers from bodies that have been dead 1d4 days. Clerics of 8th to 14th level can speak to corpses that have been dead 1d4 months. Clerics of 15th level or higher can gain answers from a corpse of any age as long as the body is still relatively intact. Take note that there is a dice roll involved here. A 7th level cleric attempting to speak with a 2 day old corpse, for example, might still fail. His 1d4 roll might indicate that he can only communicate with a 1 day old corpse with his attempt at the spell.

Speak with Plants

Level: Cleric 3, Druid 3

Range: Personal

Duration: 1 hour

The caster can speak with and understand the speech of plants. Plants that are smaller than trees obey the druid's commands and move aside when requested, etc.

Spectral Force

Level: Magic-User 3

Range: 240'

Duration: Concentration + 3 rounds

As *phantasmal force*, except that sound, smell, and thermal illusions are included in the spell effect. While concentrating, you can move the image within the range. The image disappears when struck by an opponent unless you cause the illusion to react to the blow.

Spectral Hand

Level: Magic-User 2

Range: 120'

Duration: 1 minute

A ghostly, glowing hand shaped from your life force materializes and moves as you desire, allowing you to deliver low-level, touch range spells at a distance. On casting the spell, you lose 1d4 hit points that return when the spell ends (even if it is dispelled), but not if the hand is destroyed. For as long as the spell lasts, any touch range spell of 4th level or lower that you cast can be delivered by the spectral hand. The hand always strikes from your direction. The hand cannot flank

targets like a creature can. After it delivers a spell, or if the hand goes beyond the spell range, goes out of your sight, the hand returns to you and hovers. The hand is incorporeal and thus cannot be harmed by normal weapons. It has your save bonuses, an AC of 20 and 1d4 hit points, the same number that you lost in creating it.

Spell Immunity I

Level: Cleric 4

Range: Touch

Duration: 1 hour

The warded creature is immune to the effects of one specified spell for every four levels you have. The spells must be of 4th level or lower. The warded creature effectively has unbeatable magic resistance regarding the specified spell or spells. It does not protect against supernatural or extraordinary abilities, such as breath weapons or gaze attacks. A creature can have only one *spell immunity* spell in effect on it at a time.

Spell Immunity II

Level: Cleric 8

Range: Touch

Duration: 1 hour

This spell functions like *spell immunity I*, except the immunity applies to spells of 8th level or lower. A creature can have only one *spell immunity* spell in effect on it at a time.

Spellstaff

Level: Druid 6

Range: Touch

Duration: Permanent until discharged

You store one spell that you can normally cast in a wooden staff. Only one such spell can be stored in a staff at a given time, and you cannot have more than one *spellstaff* at any given time. You can cast a spell stored within a staff just as though it were among those you had prepared, but it does not count against your normal allotment for a given day.

Spell Turning

Level: Magic-User 7

Range: Personal

Duration: Until expended or 1 hour

Spells targeted on you are turned back upon the original caster. The abjuration turns only spells that have you as

a target. Effect and area spells are not affected. *Spell turning* also fails to stop ray spells.

1d4+6 spell levels are affected by the turning. The exact number is rolled secretly.

If a spell rebounds between two spell casters under the effect of *spell turning*, roll d% to determine the result.

d%	Effect
01-70	Spell drains away without effect
71-80	Spell affects both of you equally at full effect
81-97	Both effects are nonfunctional for 1d4 minutes
98-00	Both of you go through a rift into another plane

Spider Climb

Level: Druid 2, Magic-User 2

Range: Touch

Duration: 30 minutes

The subject can climb and travel on vertical surfaces or even traverse ceilings as well as a spider does. The affected creature must have its hands free to climb in this manner. The subject climbs at a speed of 20' per round.

Spike Growth

Level: Druid 3

Range: 120'

Duration: 1 hour

Any ground-covering vegetation in the spell's area (3' radius per level) becomes very hard and sharply pointed without changing its appearance. In areas of bare earth, roots and rootlets act in the same way. Typically, *spike growth* can be cast in any outdoor setting except open water, ice, heavy snow, sandy desert, or bare stone. Any creature moving on foot in the spell's area takes 1d4 points of piercing damage for each 5' of movement. Any creature that is damaged by this spell must also succeed on a saving throw or be crippled for 24 hours or until the injured creature is healed.

Spike Stones

Level: Cleric 4, Druid 4

Range: 120'

Duration: 10 hours

Rocky ground, stone floors, and similar surfaces shape themselves into long, sharp points that blend into the background. *Spike stones* impede progress through an area (3' radius per level) and deal damage. Any creature moving on foot through the spell's area moves at half

speed. In addition, each creature moving through the area takes 1d8 points of piercing damage for each 5' of movement. Any creature that is damaged by this spell must also succeed on a saving throw to avoid being crippled for 24 hours or until healed.

Spiritual Hammer

Level: Cleric 2
Range: 120'
Duration: 3 rounds

A warhammer pops into existence and attacks opponents as you direct it, dealing 1d8 points of damage per hit. The attacks use your attack bonus.

Statue

Level: Magic-User 7
Range: Touch
Duration: 24 hours

You turn the target into a stone statue, along with any garments and equipment worn or carried. In statue form, the subject gains the hardness of stone. The subject retains its own hit points. It can see, hear, and smell normally, but does not need to eat or breathe. Feeling is limited to those sensations that can affect the granite-hard substance of the individual's body. Chipping is equal to a mere scratch, but breaking off one of the statue's arms constitutes serious damage. The subject of a *statue* spell can return to its normal state, act, and then return instantly to the statue state if it so desires, as long as the spell is still in effect.

Status

Level: Cleric 2
Range: Touch
Duration: 3 hours

When you need to keep track of comrades who may get separated, status allows you to mentally monitor their relative positions and general condition. The spell affects one creature per three caster levels, all of whom must be touched by the spell caster.

Sticks to Snakes

Level: Cleric 4, Druid 5
Range: 60'
Duration: 1 hour

The caster may turn as many as 2d8 normal sticks into snakes, each one having a 50% chance of being a viper.

The snakes follow his commands, but turn back into sticks at the end of the spell or when killed.

Stinking Cloud

Level: Magic-User 3
Range: 120'
Duration: 1 minute

This spell creates a bank of fog, like that created by *fog cloud*, except that the vapors are nauseating. Living creatures in the cloud are sickened. These effects last as long as the character is in the cloud and for 1d4+1 rounds after he or she leaves it. Those who succeed at a saving throw but remain in the cloud must continue to roll saving throws each round.

Stomp

Level: Magic-User 2
Area: 20' radius
Duration: Instantaneous

Your foot or staff stomp creates a shock wave, toppling creatures and loose objects. The shock wave affects only creatures standing on the ground within the spell's area. Creatures that fail a saving throw are thrown to the ground and take 1d4 points of damage.

Stone Shape

Level: Druid 3, Magic-User 4
Range: Touch
Duration: Instantaneous

You can form 1 cubic foot of stone + 1 cubic foot per level into any shape. While it's possible to make crude coffers, doors, and so forth with stone shape, fine detail isn't possible. There is a 30% chance that any shape including moving parts does not work. Druids increase this to 3 cubic feet + 1 cubic foot per level.

Stoneskin

Level: Druid 5, Magic-User 4
Range: Touch
Duration: 1 hour or until discharged

The warded creature gains immunity to one round of physical attacks from the next creature that attacks him. The spell does not protect from damage from spells.

Component: Diamond dust (250 gp)

Stone Tell

Level: Cleric 6, Druid 6

Range: Personal

Duration: 10 minutes

You gain the ability to speak with stones, which relate to you who or what has touched them as well as revealing what is covered or concealed by them.

Storm of Vengeance

Level: Druid 9

Range: 240'

Duration: Concentration (max. 10 rounds)

This spell creates a black storm cloud 360' in radius. Lightning and claps of thunder appear in the storm. Each creature beneath the cloud must succeed on a saving throw or be deafened for 1d4 turns. If you do not maintain concentration after casting it, the spell ends. If you do concentrate, the spell generates additional effects in each following round, as noted below. Each effect occurs during your turn.

Round 2: Acid rain deal 1d6 acid damage to all creatures beneath the cloud (no save).

Round 3: You call six bolts of lightning down from the cloud. You decide where they strike. No two bolts may be directed at the same target. Each bolt deals 10d6 points of electricity damage.

Round 4: Hailstones rain down in the area, dealing 5d6 points of damage (no save).

Round 5-10: Violent rain and wind obscures all sight beyond 5'. Attacking foes more than 5' away is done at a -6 penalty. Creatures farther away are -10 to attack. Speed is reduced by three-quarters. Ranged attacks within the area of the storm are impossible. Spells cast within the area are disrupted unless the caster succeeds on a saving throw.

Strength

Level: Cleric 2, Druid 2, Magic-User 2

Range: Touch

Duration: 1 hour

The spell grants the subject 18 strength. This cannot be made permanent.



Suggestion

Level: Magic-User 3

Range: 30'

Duration: 1 week

The caster speaks a hypnotic *suggestion* to his victim. If the victim fails a save he carries out the suggestion as long as it can be performed within a week. A suggestion of suicide is only 1% likely to be obeyed.

Summon Monster I

Level: Cleric 1, Magic-User 1

Range: 30'

Duration: 1 minute

The caster summons allies, who serve him until slain or until the duration of the spell expires. The caster can summon monsters of one challenge level. See the table below for the number that can be summoned. Casters cannot summon creatures of opposed alignment.

Summon Monster II

Level: Cleric 2, Magic-User 2

As *summon monster I*, but see table below for the creatures that can be summoned.

Summon Monster III

Level: Cleric 3, Magic-User 3

As *summon monster I*, but see table below for the creatures that can be summoned.

Summon Monster IV

Level: Cleric 4, Magic-User 4

As *summon monster I*, but see table below for the creatures that can be summoned.

Summon Monster V

Level: Cleric 5, Magic-User 5

As *summon monster I*, but see table below for the creatures that can be summoned.

Summon Monster VI

Level: Cleric 6, Magic-User 6

As *summon monster I*, but see table below for the creatures that can be summoned.

Summon Monster VII

Level: Cleric 7, Magic-User 7

As *summon monster I*, but see table below for the creatures that can be summoned.

Summon Monster VIII

Level: Cleric 8, Magic-User 8

As *summon monster I*, but see table below for the creatures that can be summoned.

Summon Monster IX

Level: Cleric 9, Magic-User 9

As *summon monster I*, but see table below for the creatures that can be summoned.

Summon Monster Spell									
CL	I	II	III	IV	V	VI	VII	VIII	IX
0	1d2	1d4	1d6	-	-	-	-	-	-
1	1	1d2	1d4	1d6	-	-	-	-	-
2	-	1	1d2	1d4	1d6	-	-	-	-
3	-	-	1	1d2	1d4	1d6	-	-	-
4	-	-	-	1	1d2	1d4	1d6	-	-
5	-	-	-	-	1	1d2	1d4	1d6	-
6	-	-	-	-	-	1	1d2	1d4	1d6
7	-	-	-	-	-	-	1	1d2	1d4
8	-	-	-	-	-	-	-	1	1d2
9	-	-	-	-	-	-	-	-	1

Summon Nature's Ally I

Level: Druid 1

Range: 30'

Duration: 1 minute

As *summon monster I*, save it only summons animals, elementals, fey, plants and vermin.

Summon Nature's Ally II

Level: Druid 2

As *summon monster II*, save it only summons animals, elementals, fey, plants and vermin.

Summon Nature's Ally III

Level: Druid 3

As *summon monster III*, save it only summons animals, elementals, fey, plants and vermin.

Summon Nature's Ally IV

Level: Druid 4

As *summon monster IV*, save it only summons animals, elementals, fey, plants and vermin.

Summon Nature's Ally V

Level: Druid 5

As *summon monster V*, save it only summons animals, elementals, fey, plants and vermin.

Summon Nature's Ally VI

Level: Druid 6

As *summon monster VI*, save it only summons animals, elementals, fey, plants and vermin.

Summon Nature's Ally VII

Level: Druid 7

As *summon monster VII*, save it only summons animals, elementals, fey, plants and vermin.

Summon Nature's Ally VIII

Level: Druid 8

As *summon monster VIII*, save it only summons animals, elementals, fey, plants and vermin.

Summon Nature's Ally IX

Level: Druid 9

As *summon monster IX*, save it only summons animals, elementals, fey, plants and vermin.

Summon Swarm

Level: Druid 2, Magic-User 2

Range: 30'

Duration: Concentration + 2 rounds

You summon a swarm of bats, rats, or spiders (see *Monster book*), which attacks all other creatures in the area. If no living creatures are within the swarm's area, it attacks or pursues the nearest creature as best it can. The caster has no control over it.

Sunbeam

Level: Druid 7

Range: 60' long beam

Duration: 1 minute or until all beams are fatigued

For the duration of this spell, you can evoke one dazzling beam of intense light per three levels each round. The spell ends when its duration runs out or your allotment of beams is fatigued. Each creature struck by a beam is blinded and takes 4d6 points of damage. Any creatures to which sunlight is harmful or unnatural take double damage. A successful saving throw negates the blindness and reduces the damage by half.

An undead creature caught within the beam takes 1d6 points of damage per caster level. In addition, the beam results in the destruction of any undead creature specifically harmed by bright light if it fails its save. The ultraviolet light generated by the spell deals damage to fungi, mold, oozes, and slimes as if they were undead.

Sunburst

Level: Druid 8, Magic-User 8

Range: 240'

Duration: Instantaneous

Sunburst causes an 80' radius globe of searing radiance to explode silently from a point you select. All creatures in the globe are blinded and take 6d6 points of damage. A creature to which sunlight is harmful or unnatural takes double damage. A successful saving throw negates the blindness and halves the damage.

An undead creature caught within the globe takes 1d6 points of damage per caster level. In addition, the burst

results in the destruction of any undead creature specifically harmed by bright light if it fails its save. The ultraviolet light generated by the spell deals damage to fungi, mold, oozes, and slimes just as if they were undead creatures.

Sunburst dispels darkness spells lower than 9th level.

Surelife

Level: Cleric 8

Range: Personal

Duration: 10 minutes

This spell allows the caster to protect herself against some condition that would ordinarily cause certain death. The character can only protect herself against a natural occurrence or condition, not against a spell or the action of a creature. The character must specify the condition against which he or she wishes to protect him or herself, and the spell is effective only against that condition. Should the character be subjected to that condition during the duration of the spell, he or she feels no discomfort and takes no damage from the condition. The spell does not protect any items carried on the caster's person. At the end of the spell's duration, the condition has full normal effects if the character is still subjected to it.

Symbol of Death

Level: Cleric 8, Magic-User 8

Range: 0'

Duration: Permanent until discharged

A *symbol* creates a deadly magical trap, written into the shape of a divine rune. The rune's magic is activated when any person or creature hostile to the caster reads it, or passes over, under, or past it. *Symbol of death* deals 80 points of damage. It can be *dispelled*, but not *erased*.

Component: Mercury, phosphorous, diamond and opal dust worth 2,000 gp

Symbol of Discord

Level: Cleric 7

Range: 0'

Duration: Permanent until discharged

This spell causes those within a 20' radius spread to turn on each other rather than attack their foes. Each affected creature has a 50% chance to attack the nearest target each round. (Roll to determine each creature's behavior every round at the beginning of its turn.) A creature that

does not attack its nearest neighbor is free to act normally for that round.

Component: Mercury, phosphorous, diamond and opal dust worth 1,500 gp

Symbol of Fear

Level: Cleric 6, Magic-User 6

Range: 0'

Duration: Permanent until discharged

As symbol of death, except that it acts as a fear spell.

Component: Mercury, phosphorous, diamond and opal dust worth 1,000 gp

Symbol of Insanity

Level: Cleric 8, Magic-User 8

Range: 0'

Duration: Permanent until discharged

As symbol of death, except that up to 100 HD of creatures are driven insane by a curse (per insanity).

Component: Mercury, phosphorous, diamond and opal dust worth 1,500 gp

Symbol of Pain

Level: Cleric 5, Magic-User 5

Range: 0'

Duration: Permanent until discharged

As symbol of death, except that the victim suffers wracking pain that imposes a -4 penalty on attack rolls and saves. These effects last for 1 hour after the creature moves more than 60' from the symbol.

Component: Mercury, phosphorous, diamond and opal dust worth 750 gp

Symbol of Persuasion

Level: Cleric 6, Magic-User 6

Range: 0'

Duration: Permanent until discharged

As symbol of death, except that victim is charmed by the caster (as charm monster) for 1 day.

Component: Mercury, phosphorous, diamond and opal dust worth 1,000 gp

Symbol of Sleep

Level: Cleric 5, Magic-User 5

Range: 0'

Duration: Permanent until discharged

As symbol of death, except that it casts a sleep spell affecting double the normal number of creatures and with double the normal duration.

Component: Mercury, phosphorous, diamond and opal dust worth 750 gp

Symbol of Stunning

Level: Cleric 7, Magic-User 7

Range: 0'; see text

Duration: Permanent until discharged

As symbol of death, except that 150 HD of creatures are affected as per a power word, stun.

Component: Mercury, phosphorous, diamond and opal dust worth 1,500 gp

Symbol of Weakness

Level: Cleric 7, Magic-User 7

Range: 0'; see text

Duration: Permanent until discharged

As symbol of death, except that every creature within 60 feet suffers 3d6 points of strength damage for 1 hour.

Component: Mercury, phosphorous, diamond and opal dust worth 1,500 gp

Sympathy

Level: Druid 9, Magic-User 8

Range: 30'

Duration: 1 day

You cause an object or location to emanate magical vibrations that attract either a specific kind of intelligent creature or creatures of a particular alignment. The creature to be affected must be named specifically, thus bugbears or neutral evil creatures. Creatures of the specified kind or alignment feel elated and pleased to be in the area or desire to touch or to possess the object. The compulsion to stay in the area or touch the object is overpowering. If the creature passes a saving throw, they are released from the spell, but a subsequent save must be made 1d6 x 10 minutes later. If this save fails, the affected creature attempts to return to the area or object.

Component: Pearl dust worth 1,500 gp

Telekinesis

Level: Magic-User 5

Range: 240'

Duration: Concentration (up to 1 round/ level)

You move objects or creatures by concentrating on them. Depending on the version selected, the spell can provide a gentle, sustained force, perform a variety of combat maneuvers, or exert a single violent thrust.

Sustained Force: A sustained force moves an object weighing no more than 25 pounds per caster level up to 20 feet per round. A creature can negate the effect on an object it possesses with a successful saving throw or with magic resistance. You must concentrate while using this version of the spell. The spell ends if the object is forced beyond the range. An object can also be manipulated as if with one hand. For example, a lever or rope can be pulled or a key can be turned.

Combat Maneuver: Once per round, you use *telekinesis* to perform a bull rush, disarm, grapple or trip attack. Use your caster level in place of your attack bonus and your intelligence modifier (for magic-users) or charisma modifier (for sorcerers) in place of your strength or dexterity modifier. You must concentrate the entire time you are using this version of the spell.

Violent Thrust: You can hurl one object or creature per caster level that is within range toward any target within range. You can hurl up to a total weight of 25 pounds per caster level. You must succeed on attack rolls to hit the target with the items, using your attack bonus plus your intelligence (for mages) or charisma (for sorcerers) modifier in place of your dexterity modifier. Weapons cause standard damage. Other objects cause 1d6 points of damage per 25 pounds.

Telekinetic Sphere

Level: Magic-User 8

Range: 30'

Duration: 1 minute/level

This spell functions like *resilient sphere*, with the addition that the creatures or objects inside the globe are nearly weightless. You can telekinetically lift anything in the sphere that normally weighs 5,000 pounds or less. The telekinetic control extends from you out to medium range after the sphere has succeeded in encapsulating its contents. You can move the sphere 30' in a round.

Telepathic Bond

Level: Magic-User 5

Range: 30'

Duration: 1 hour

You forge a telepathic bond among yourself and a number of willing creatures equal to 1 + 1 per 3 levels, each of which must have an intelligence score of 3 or higher and be within range when you cast the spell. Each creature included in the link is linked to all the others. The creatures can communicate telepathically through the bond regardless of language. No special power or influence is established as a result of the bond. Once the bond is formed, it works over any distance, although not from one plane to another. If desired, you may leave yourself out of the telepathic bond, but this decision must be made at the time of casting.

Teleport

Level: Magic-User 5

Range: Personal and touch

Duration: Instantaneous

This spell transports the caster or another person to a destination that the caster knows, or at least knows what it looks like from a picture or a map. Success depends on how well the caster knows the location:

1. If the caster has only seen the location in a picture or through a map (i.e. his knowledge is not based on direct experience), there is only a 25% chance of success, and failure means death, for the traveler's soul is lost in the spaces between realities.
2. If the caster has seen but not studied the location, there is a 20% chance of error. If there is an error, there is a 50% chance that the traveler arrives 1d10 x 10' below the intended location (with death resulting from arrival within a solid substance). If the error is high (over the 50% chance for a "low" arrival) the traveler arrives 1d10 x 10' over the targeted location and falls.

3. If the caster is personally familiar with the location, or has studied it carefully, there is only a 5% chance of error; a 1 in 6 chance of teleporting low, otherwise high. In either case, the arrival is 1d4 x 10' high or low.

Teleport without Error

Level: Magic-User 7

Range: Personal and touch

Duration: Instantaneous

This spell functions like *teleport*, except that there is no range limit and there is no chance you arrive off target. In addition, you need not have seen the destination, but in that case you must have at least a reliable description of the place to which you are teleporting. If you attempt to teleport with insufficient or misleading information, you disappear and reappear in your original location. Inter-planar travel is not possible.

Teleportation Circle

Level: Magic-User 9

Range: 0'

Duration: 3 hours

You create a circle on the floor or other horizontal surface that teleports, as *teleport without error*, any creature who stands on it to a designated spot. The spell fails if you attempt to set the circle to teleport creatures into a solid object, to a place with which you are not familiar and have no clear description, or to another plane. The circle itself is subtle and nearly impossible to notice. If you intend to keep creatures from activating it accidentally, you need to mark the circle in some way.

Component: Amber dust worth 1,000 gp

Temporal Stasis

Level: Magic-User 8

Range: Touch

Duration: Permanent

With a successful melee attack, you place the subject into a state of suspended animation. For the creature, time ceases to flow and its condition becomes fixed. The creature does not grow older. Its body functions virtually cease, and no force or effect can harm it. This state persists until the magic is removed such as by a successful *dispel magic* spell or a *freedom* spell.

Component: Diamond, emerald, ruby and sapphire dust worth a total of 5,000 gp

Thought Shield

Level: Magic-User 2

Range: Personal

Duration: 1 round

You fortify your mind against intrusions, gaining magic resistance 15% against all mind-affecting spells and special abilities. If you have this spell memorized, you can cast it when it is not your turn with a single utterance, including just before an opponent attacks you.

Time Stop

Level: Magic-User 9

Range: Personal

Duration: 1d4+1 rounds (see text)

The caster stops the passage of time in a radius about 15' centered on her. The time-stopped area does not thereafter move with the caster. Any creatures within this area are suspended in time, unable to act. The caster is not time-stopped while in the area or beyond.

Tiny Hut

Level: Magic-User 3

Range: 20' radius sphere centered on caster

Duration: 10 hours

You create an unmoving, opaque sphere of force of any color you desire around yourself to serve as a little sanctum. Half the sphere projects above the ground, and the lower hemisphere of the sphere passes through the ground, thus protecting you from burrowing creatures. As many as nine other characters can fit into the "hut" with you; they can freely pass into and out of the hut without harming it. However, if you remove yourself from the hut, the spell ends. The tiny hut is opaque from the outside, but transparent from within.

Tongues

Level: Cleric 4, Magic-User 3

Range: Touch

Duration: 1 hour

This spell grants the creature touched the ability to speak and understand all languages.

Touch of Fatigue

Level: Magic-User 1

Range: Touch

Duration: 1 round

Your touch leaves your target fatigued for the spell's duration.

Touch of Idiocy

Level: Magic-User 2

Range: Touch

Duration: 1 hour

Your touch applies a 1d6 penalty to the target's intelligence, wisdom and charisma scores. This penalty cannot reduce any of these scores below 1. For monsters,

reduce their intelligence by one level (e.g. average to low) and impose a -2 penalty on their saves.

Tower of Iron Will

Level: Magic-User 5

Range: 10' radius centered on you

Duration: 1 round

You generate a bastion of thought so strong that it offers protection to you and everyone around you. You and all creatures in the spell's area gain magic resistance 45% against all mind-affecting spells and special abilities. If you have this spell memorized, you can cast it when it is not your turn with a single utterance, including just before an opponent attacks you.

Transformation

Level: Magic-User 6

Range: Personal

Duration: 10 rounds

You become a virtual fighting machine. Your mind-set changes so that you relish combat and you cannot cast spells, even from magic items. You fight as a fighter of your character level. This spell requires you to drink a *potion of heroism* as you cast the spell.

Transmute Metal to Wood

Level: Druid 7

Range: 240'

Duration: Instantaneous

This spell enables you to change all metal objects within 40' of the caster into wood. A magic object can make a saving throw to resist. Artifacts cannot be so transmuted. Weapons converted from metal to wood act as clubs or staves. The base AC of any armor converted from metal to wood is reduced by 2, and armor changed by this spell loses an additional point of base AC every time it is struck with a natural attack roll of 19 or 20.

Transmute Rock to Mud/Transmute Mud to Rock

Level: Druid 5, Magic-User 5

Range: 120'

Duration: Permanent; see text

This spell transmutes rock and any other form of earth into mud. An area of roughly 300' x 300' becomes a mire, reducing movement by 90%.

The reverse transmutes mud (and only mud) into rock.



Transport via Plants

Level: Druid 6

Range: Unlimited

Duration: 1 round

You can enter any normal plant and pass any distance to a plant of the same kind in a single round, regardless of the distance separating the two. The entry plant must be alive and large enough to contain you. The destination plant need not be familiar to you, but must be alive. If you are uncertain of the location of a particular kind of destination plant, you need merely designate direction and distance and the *transport via plants* spell moves you as close as possible to the desired location. You may also bring one additional willing person per three caster levels. The destruction of an occupied plant slays you and any creatures you have brought along and ejects the bodies and carried objects from the tree.

Trap the Soul

Level: Magic-User 8

Range: 30'

Duration: Permanent; see text

You force a creature's life force and its material body into a gem. The gem holds the trapped entity indefinitely or until the gem is broken and the life force is released, which allows the material body to reform. If the trapped creature is a powerful creature from another plane it can be required to perform a service immediately upon being

freed. Otherwise, the creature can go free once the gem is broken. The spell can be triggered in one of two ways:

Spell Completion: The spell is completed by speaking its final word as if you were casting a regular spell at the subject. This allows magic resistance and a saving throw to avoid the effect. If the creature's true name is spoken as well, magic resistance is ignored and the saving throw is made at a -2 penalty. If the saving throw or magic resistance is successful, the gem shatters.

Trigger Object: The second method is more insidious, for it tricks the subject into accepting a trigger object inscribed with the final spell word, automatically placing the creature's soul in the trap. To use this method, both the creature's name and the trigger word must be inscribed on the trigger object when the gem is enspelled. As soon as the subject picks up or accepts the trigger object, its life force is transferred to the gem without the benefit of magic resistance or a save.

Focus: A gem worth 1,000 gp per Hit Dice/Level of the creature to be trapped. If the gem is not valuable enough, it shatters when the entrapment is attempted.

Tree Shape

Level: Druid 2
Range: Personal
Duration: 3 hours

You take the form of a large tree or shrub. The closest inspection cannot reveal that the tree is not just a normal tree or shrub. While in tree form, you can observe all that transpires around you just as if you were in your normal form. Your hit points and saving throw score remains the same. You gain a +5 bonus to Armor Class but have an effective 0 dexterity and a 0' movement rate.

Tree Stride

Level: Druid 5
Range: Personal
Duration: 10 hours or until expended; see text

You gain the ability to enter trees and move from one tree to another. The first tree you enter and all others you enter must be of the same kind, must be alive, and must be big enough to contain you. By moving into an oak tree, for example, you instantly know the location of all other oak trees within transport range (see below) and may choose whether you want to pass into one or step back out of the tree you moved into. You may

choose to pass to any tree of the appropriate kind within the transport range as shown on the following table.

Type of Tree	Transport Range
Oak, ash, yew	3,000'
Elm, linden	2,000'
Other deciduous	1,500'
Any coniferous	1,000'
All other trees	500'

You may move into a tree up to one time per caster level. Passing from one tree to another tree counts as moving into one tree. The spell lasts until the duration expires or you exit a tree.

You can, at your option, remain within a tree without transporting yourself, but you are forced out when the spell ends. If the tree in which you are concealed is chopped down or burned, you are slain.

True Creation

Level: Cleric 8
Range: 0'
Duration: Instantaneous

The caster creates a non-magical object of any sort of matter. Items created are permanent and cannot be negated by *dispel magic* or similar spells. The volume of the item created cannot exceed 1 cubic foot per caster level. The caster must roll 1d20 equal to or under her intelligence score to make a complex item. Unlike the items brought into being by *creation I* and *creation II*, objects created by this spell can be used as a material component or focus for spells.

True Resurrection

Level: Cleric 9
Range: Touch
Duration: Instantaneous

As *raise dead*, except that you can resurrect a creature that has been dead for as long as 10 years per caster level. This spell can even bring back creatures whose bodies have been destroyed, provided that you unambiguously identify the deceased in some fashion (reciting the deceased's time and place of birth or death is the most common method). You can revive someone killed by a death effect or someone who has been turned into an undead creature and then destroyed. This spell can also resurrect elementals or outsiders, but it cannot resurrect constructs or undead creatures. Even *true resurrection* cannot restore to life a creature that has died of old age. The creature is immediately restored to

full hit points, vigor, and health, with no loss of level or constitution points or prepared spells.

Component: Holy water

True Seeing

Level: Cleric 5, Druid 7, Magic-User 6

Range: Touch

Duration: 1 minute/level

You confer on the subject the ability to see through normal and magical darkness, invisibility, blur, displacement and illusions, to notice secret doors hidden by magic, and to see the true form of polymorphed, changed, or transmuted things. The subject can focus its vision to see into the Ethereal Plane, but not into extra-dimensional spaces.

Component: Ointment for the eyes composed of mushroom powder, saffron and fat aged for 1d6 months

True Strike

Level: Magic-User 1

Range: Personal

Duration: See text

Your next single attack roll (if it is made before the end of the next round) gains a +10 bonus to attack.

Two Dimensional

Level: Magic-User 8

Range: Personal

Duration: 10 minutes

This spell allows the spell caster to exist in only two dimensions, height and width. With no depth, the spell caster is functionally invisible to people looking at him from the side (they have a 10% chance of noticing him, or 1% chance if he is trying to avoid detection and standing still). When so turned, the magic-user enjoys a +10 bonus to Armor Class against ranged attacks and thrusting weapons. The two dimensional spellcaster can also move through narrow spaces.

Ultrablast

Level: Magic-User 7

Range: 15' radius

Duration: Instantaneous

You release a horrid psychic shriek from your subconscious that disrupts the brains of all enemies within 15', dealing 13d6 points of damage to each enemy.

Undeath to Death

Level: Cleric 6, Magic-User 6

Range: 150' radius

Duration: Instantaneous

This spell functions like *circle of death*, except that it destroys undead creatures within a 1500' radius burst.

Undetectable Alignment

Level: Cleric 2

Range: 30'

Duration: 24 hours

Undetectable alignment conceals the alignment of an object or a creature from all forms of divination.

Unseen Servant

Level: Magic-User 1

Range: 30'

Duration: 1 hour

An *unseen servant* is an invisible, mindless, shapeless force that performs simple tasks at your command. The servant can perform only one activity at a time. It has an effective strength score of 2 (so it can lift 20 pounds or drag 100 pounds). It can trigger traps and such, but it can exert only 20 pounds of force, which is not enough to activate some pressure plates and other devices. It can't perform any task that requires a saving throw. Its movement rate is 15 feet per round.

The unseen servant cannot attack in any way. It cannot be killed, but it dissipates if it takes 6 points of damage from area attacks (no save.) If you attempt to send it beyond the spell's range (measured from your current position), the servant ceases to exist.

Vampiric Touch

Level: Magic-User 3

Range: Touch

Duration: Instantaneous/1 hour; see text

Your touch deals 1d3 points of damage per caster level, and you gain temporary hit points equal to the damage you deal. However, you cannot gain more than the subject's current hit points, which is enough to kill them. The temporary hit points disappear 1 hour later.

Vanish

Level: Magic-User 7

Range: Touch

As *teleport*, except that it teleports an object that weighs no more than 50 pounds/level. Creatures and magical forces cannot be teleported. If desired, the target object can be sent to a distant location on the Ethereal Plane. In this case, the point from which the object was teleported remains faintly magical until the item is retrieved. A successful targeted *dispel magic* cast on that point brings the vanished item back from the Ethereal Plane.

Veil

Level: Magic-User 6

Range: 240'

Duration: Concentration + 10 hours

You change the appearance of the one or more subjects within a 30' radius. You can make the subjects appear to be anything you wish. They look, feel, and smell just like the creatures the spell makes them resemble. Affected creatures resume their normal appearance if they are slain. Those who interact with the subjects can attempt saving throws to see through the illusion, but magic resistance does not help.

Ventriloquism

Level: Magic-User 1

Range: 30'

Duration: 10 minutes

You can make any sound that you can make vocally seem to issue from someplace else. Those who save vs. the spell recognize it as illusory, but still hear it.

Vision

Level: Magic-User 7

Range: Personal

Duration: Instantaneous

As *legend lore*, except that it works instantly.

Wail of the Banshee

Level: Magic-User 9

Range: 30'

Duration: Instantaneous

You emit a terrible scream that kills creatures that hear it (except for yourself) within 30'. Creatures closest to the point of origin are affected first.

Wall of Fire

Level: Druid 5, Magic-User 4

Range: 120'

Duration: Concentration

A wall of fire flares into being and burns for as long as you concentrate on it. Creatures with 3 or fewer hit dice cannot pass through it, and no creature can see through it to the other side. Passing through the fire inflicts 1d6 hit points of damage (no saving throw) and undead creatures sustain twice the normal damage. The caster may choose to create a straight wall 60' long x 20' high, or a circular wall with a 15' radius and 20' high.

Wall of Force

Level: Magic-User 5

Range: 30'

Duration: 1 minute

This spell creates an invisible wall of force whose area is 10 square feet per level. The wall cannot move, it is immune to damage of all kinds and it is unaffected by most spells, including *dispel magic*. *Disintegrate* immediately destroys it, as does a *rod of cancellation*, a *sphere of annihilation*, or a *mage's disjunction* spell. Breath weapons and spells cannot pass through the wall in either direction. It blocks ethereal creatures as well as material ones (though ethereal creatures can usually get around the wall by floating under or over it through material floors and ceilings). Gaze attacks can operate through a wall of force.

Wall of Ice

Level: Magic-User 4

Range: 120'

Duration: Concentration

The caster conjures up a non-transparent wall of ice 6' thick. The caster may choose to create a straight wall 60' long and 20' high, or a circular wall with a 15' radius, also 20' high. Creatures with 3 or fewer HD cannot affect the wall, but creatures of 4 or more HD are able to smash through it, taking 1d6 points of damage in the process. Creatures with fire-based metabolisms take 2d6 instead of the normal 1d6 damage. Fire spells and magical effects are negated in the vicinity of the wall.

Wall of Iron

Level: Magic-User 6

Range: 120'

Duration: 2 hours

The caster conjures an iron wall from thin air. The wall is 3' thick, up to 50' tall and up to 50' long.

Wall of Stone

Level: Cleric 5, Druid 6, Magic-User 5
Range: 120'
Duration: Permanent until dispelled

The wall of stone conjured by this spell is 2' thick, with a surface area of up to 1,000 square feet.

Wall of Thorns

Level: Druid 5
Range: 120'
Duration: 2 hours

A *wall of thorns* spell creates a barrier of tough, tangled brush bearing needle-sharp thorns as long as a human's finger. Any creature forced into or attempting to move through a wall of thorns takes damage each round equal to 25 minus their Armor Class.

You can make the wall as little as 5' thick, which allows you to shape the wall as a number of 10' x 10' x 5' cubes equal to twice your caster level. This has no effect on the damage dealt by the thorns, but any creature attempting to break through takes that much less time to force its way through the barrier. Chopping away at the wall creates a safe passage 1' deep for every 10 minutes of work. Normal fire cannot harm the wall, but magical fire burns it away in 1 turn.

A wall of thorns is not actually a living plant, and thus is unaffected by spells that affect plants.

Warp Wood

Level: Druid 2
Range: 30'
Duration: Instantaneous

You cause wood to permanently warp. A warped door springs open or becomes stuck at your option. A boat or ship springs a leak. Warped ranged weapons are useless. A warped melee weapon has a -2 penalty on attack rolls. Alternatively, you can unwarped wood with this spell. *Make whole* cannot repair warped wood items.

Water Breathing

Level: Druid 3, Magic-User 3
Range: Touch
Duration: 2 hours

The recipient of the spell is able to breathe underwater until the spell's duration expires.

Water Walk

Level: Cleric 3
Range: Touch
Duration: 1 hour

The transmuted creatures can tread on any liquid as if it were firm ground. Creatures crossing molten lava still take damage from the heat. If the spell is cast underwater or while the subjects are partially or wholly submerged the subjects are borne toward the surface at 60 feet per round.

Waves of Fatigue

Level: Magic-User 5
Area: 30' cone
Duration: Instantaneous

All living creatures in the spell's area are fatigued (see Conditions in Rules of Play).



Web

Level: Magic-User 2

Range: 120'

Duration: 8 hours

Fibrous, sticky webs fill an area up to 10' x 10' x 20'. It is extremely difficult to get through the mass of strands, taking one turn if torch, sword or flaming sword is used, and creatures larger than a horse can break through in 2 turns. Humans take longer to break through, perhaps 3-4 turns or longer.

Weird

Level: Magic-User 9

Range: 120'

Duration: Instantaneous

As *phantasmal killer*, except it affects any number of creatures, no two of which can be more than 30' apart.

Whirlwind

Level: Druid 8

Range: 240'

Duration: 1 minute

This spell creates a powerful cyclone of raging wind 10' wide at base, 30' wide at top and 30' tall that moves through the air, along the ground, or over water at a speed of 60 feet per round. You control the cyclone's movement. If the cyclone exceeds the spell's range, it moves in a random, uncontrolled fashion for 1d3 rounds and then dissipates. (You can't regain control of the cyclone, even if comes back within range.)

Any large or smaller creature that comes in contact with the spell effect must succeed on a saving throw or take 3d6 points of damage. A medium or smaller creature that fails its save is picked up bodily by the cyclone and held suspended in its powerful winds, taking 1d8 points of damage each round on your turn with no save allowed. You may direct the cyclone to eject any carried creatures whenever you wish, depositing them souls wherever the cyclone happens to be when they are released.

Whispering Wind

Level: Magic-User 2

Range: 1 mile/level

Duration: 1 hour/level or until discharged

You send a message or sound on the wind to a designated spot. The whispering wind travels to a specific location within range that is familiar to you,

provided that it can find a way to the location. A whispering wind is as gentle and unnoticed as a zephyr until it reaches the location. It then delivers its whisper-quiet message or other sound. Note that the message is delivered regardless of whether anyone is present to hear it. The wind then dissipates.

Wind Walk

Level: Cleric 6, Druid 7

Range: Touch

Duration: 1 day or until dispelled

The caster and one other person in contact with him become incorporeal and mist-like, able to travel through walls and other obstacles. The cleric or druid can bring this companion along, traveling at a movement rate of 60' indoors and in subterranean settings, and at a rate of 120' outdoors.

Wind Wall

Level: Druid 3, Magic-User 3

Range: 120'

Duration: 1 minute

An invisible vertical curtain of wind 2' thick deflects non-magic missiles, gases and breath weapons. The wind wall is 60 feet long and 30 feet high. It is possible to create cylindrical or square *wind walls* to enclose points.

Wisdom

Level: Cleric 2, Druid 2, Magic-User 2

Range: Touch

Duration: 1 hour

The spell grants the subject an 18 wisdom. This cannot be made permanent.

Wish

Level: Magic-User 9

Range: See text

Duration: See text

This spell is not all-powerful. It grants wishes of limited scope, although more powerful than a *limited wish*. The Treasure Keeper rules what sort of wishes are within the spell's power in her campaign. After casting *wish*, the magic-user is too mentally drained to cast any spells for a period of 1d4 days.

Wizard Eye

Level: Magic-User 4
Range: 240'
Duration: 1 hour

The caster conjures up an invisible, magical "eye," that can move a maximum of 240' from its creator. It floats along as directed by the caster, at a rate of 5'. The caster can see through this eye as though he was seeing with his own eyes.

Wizard Lock

Level: Magic-User 2
Range: Touch
Duration: Permanent

Wizard lock holds a door closed, and is permanent until dispelled. Creatures with magic resistance can shatter the spell without effort. Any magic-user three levels or higher than the caster can open the portal, and *knock* opens it as well, although the spell is not permanently destroyed in these cases.

Wizard Mark

Level: Magic-User 1
Range: 0'
Duration: Permanent

This spell allows you to inscribe a personal rune or mark, which can consist of no more than six characters. The writing can be visible or invisible. *Detect magic* causes the mark to glow and be visible. If placed on a living creature, the glyph fades in a month.

Wood Shape

Level: Druid 2
Range: Touch
Duration: Instantaneous

You form one piece of wood (up to 30 pounds per level) into any shape that suits your purpose. While it is possible to make crude coffers, doors, and so forth, fine detail is not possible. There is a 30% chance that any shape that includes moving parts does not work.

Word of Recall

Level: Cleric 6, Druid 8
Range: Unlimited
Duration: Instantaneous

You *teleport without error* back to your sanctuary.

Zone of Truth

Level: Cleric 2
Range: 30'
Duration: 5 minutes

Creatures within a 20' radius area or those who enter that area while it lasts cannot speak a lie unless they succeed at a saving throw. Affected creatures are aware of this enchantment. Creatures that leave the area are free to spout falsehoods like a politician on the stump.

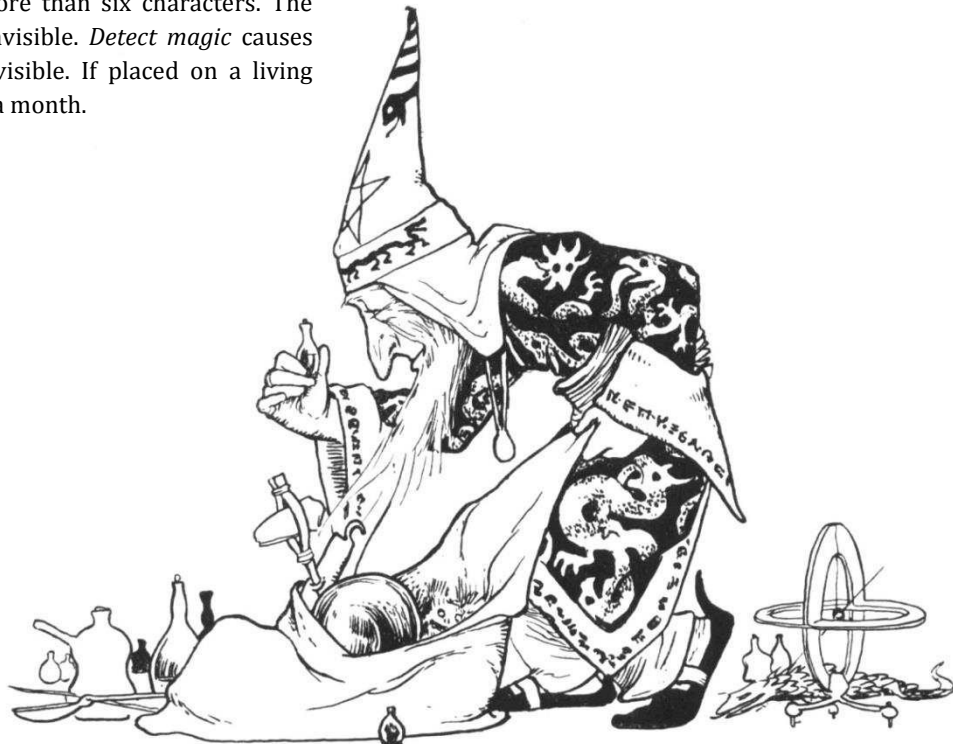

Halt Ye Varlets!

What follows is for the eyes of the Treasure Keeper only. Turn back to Chapter 2, roll up a character, and wait patiently for your game to begin. The secrets beyond this point can do nothing but ruin your sense of wonder at what is to come.

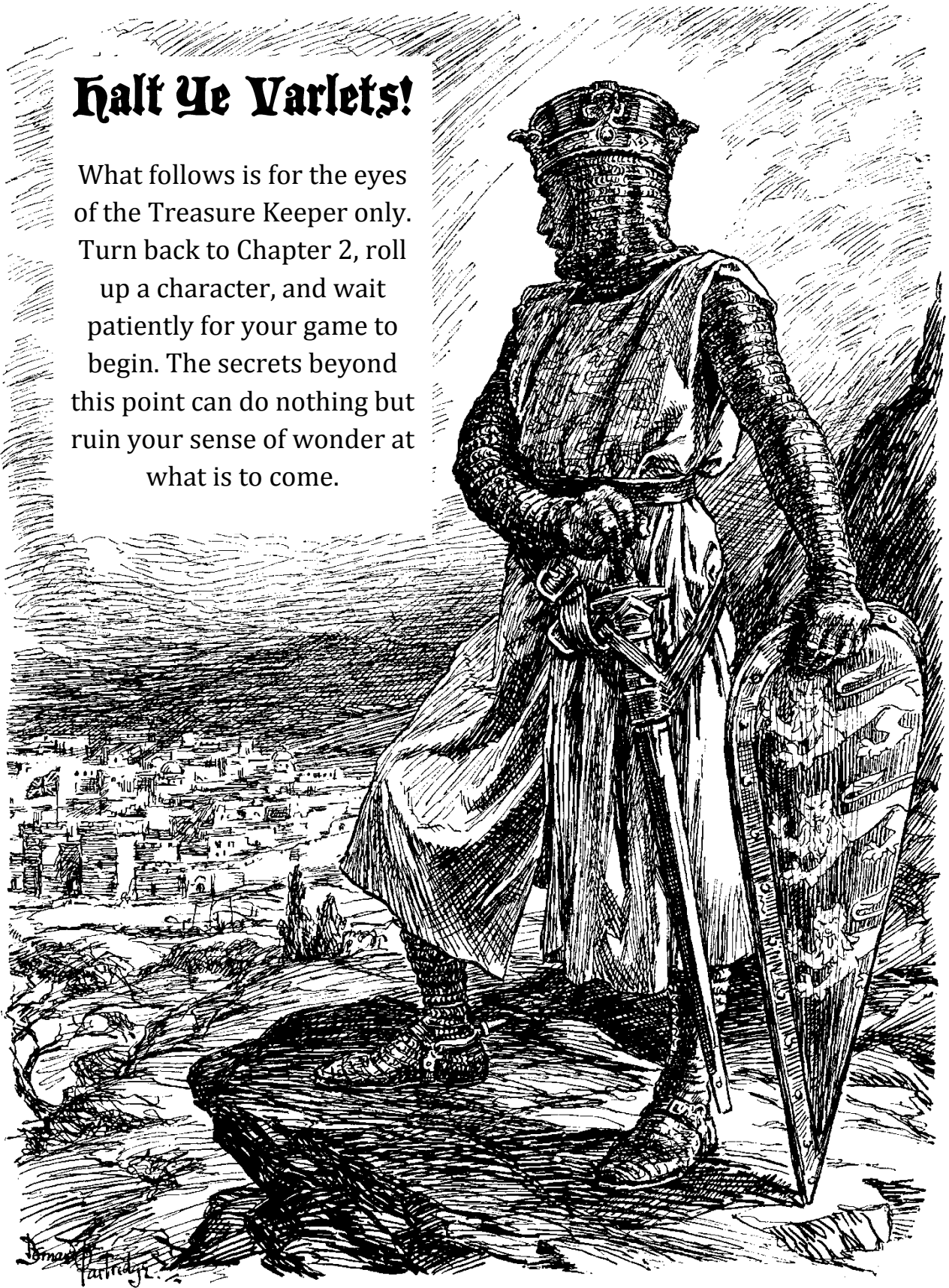

Running a Game

6

Organization and Preparation

A Treasure Keeper has no more important tasks than organization and game preparation. Preparation does not necessarily mean pre-planning every aspect of an adventure – in fact, it really shouldn't – but rather pre-planning in such a way that all of the materials you are going to need for your game are present and ready to go.

It is important to keep a game moving; every time you have to stop the game to look up a rule or figure out how much fuel is left in the fighter's lantern or how a trap or spell is supposed to work, the players' minds begin drifting elsewhere. Somebody gets up to fetch a can of pop, somebody else begins doodling on their character sheet, a couple of people begin discussing the latest and greatest movie in the theaters, and getting them back into the game can be difficult.

First and foremost, you need to understand the rules as well as possible. If you know you are going to be running magic-using NPC's or creatures, you need to make sure you understand how their spells work. You also need to have thoroughly read and understood the adventure you are running, even if you wrote it yourself. You do not want to get into a situation where you have to go back on what you just described and call for a "do-over".

Saying Yes and Saying No

As the referee of the game, the Treasure Keeper often finds it necessary to say "no" to players. Players don't like this, but saying "no" is important to keeping the game fair and keeping tempers in check.

Note that "fair" does not mean "everyone gets whatever they want". Rather, it means that no one player gets an undue advantage over another player due to cheating on their part or on the part of the Treasure Keeper.

On the other hand, a wise TK also learns to say "yes". *Blood & Treasure* is inspired by fairy tales, pulp fiction

and movies. That means it's not entirely realistic. Players have a tendency to come up with all sorts of weird plans and schemes in a game. This shows that they're thinking and are engaged in the game. So feel free to say yes to some of these ideas, provided they don't specifically break the rules or artificially alter them. In general, player invention is a good thing.

However, player invention can also lead to players finding ways to get around the rules to overcome challenges. Just because you allow player invention, it doesn't mean that you have to roll over for that invention or make it easy. Remember the old standby of role-playing games: The 1% chance of success. Yes, the players can try to plug the rift in space-time with an iron spike ... but there is only a 1% chance that the plan will work. Remember, they are called "plans that are so crazy that it just might work", not "plans that are so crazy that they will work every time the players try them".

What follows are a few tips that you may find useful, especially if you are new to refereeing.

Don't Do All the Work Yourself

Being the Treasure Keeper is a tremendous amount of work in terms of adventure prep, time tracking, playing the roles of every single man, woman, child and monster that the players come across, etc. Don't do all of the work yourself. Players absolutely must pitch in. They should understand the rules as well as you do, and they must understand the rules that apply to their character. If the spellcaster hasn't taken the time to read and understand how their spells work, you should have no qualms about disallowing them from casting them, or just making up the effects of the spell on your own in the worst possible way for the player.

Don't Do All the Work Yourself

Players need to show up to the game motivated to play it. They need to have a desire to explore and discover, willingness to deal with bad news and the final decisions of the Treasure Keeper, and most importantly they must be willing to get into the spirit of the game. When players begin seriously asking "Why would anyone delve into a dungeon anyways?" they are clearly not participating in the spirit of the game.

Game versus Story

Perhaps the most important thing to remember about a game of *Blood & Treasure* is that it is a game, not a story. People often tell stories about the games they have played, the stories evolving from the activities in the game and at the table, not from the Treasure Keeper attempting to force a story on the players.

Game versus Story

When a TK attempts to force players from one scene in a story to the next, the players often feel as though they have no active part in the game, and the TK feels pressure to let the players “win” so that his story can reach the resolution that he planned. Allow the game to be a game, with no set idea of where it is going. Let the player’s surprise you, and let them succeed or fail on the merits of their play and on the random roll of the dice.

Creating a Setting

The first thing you must determine when you sit down to construct a setting, or “campaign world”, is its scope. It is natural to be inspired by the likes of J. R. R. Tolkien’s Middle Earth or R. E. Howard’s Hyborian Age and want to sit down with pen and paper and begin drawing a map of an entire world of imaginary countries and cities, and then to take the next step and start deciding on populations, rulers and cultures. This is understandable, but not necessarily sensible. If you are planning on running a game for high-level characters, the sorts that could reasonably embark on a globe-trotting adventure, designing a whole world for them is reasonable.

On the other hand, if you’re planning a game for mid-level characters, it might make more sense to draw up a single kingdom and its neighbors, perhaps with the identities and personalities of some key NPC’s that the PC’s might interact with drawn up in advance. If the game is for first level characters, you need to focus on the elements that are important to low level adventures, namely a dungeon to explore and a home base they can return to heal up and resupply.

Being a Treasure Keeper is a busy job, and when you’re dealing with a low-level party, energy spent on designing multiple pantheons of gods, and empires and cities they may never see (after all, not every campaign proves to be a lasting one) are wasted when they could be spent on designing engaging dungeons and interesting folks for them to meet in the local village. These are the elements that help a campaign get off to a good start, and may help to ensure that your new campaign is a success, and lasts long enough for the adventurers to one day visit the magnificent ape empire beyond the mountains that you desperately want to design. Just as beginning characters need to be concerned more with surviving their next adventure than designing the stronghold that they may be able to build someday, the starting Treasure Keeper needs to earn the right to design an entire universe by first designing an engaging adventure.

Even when you are finally are to the point when designing an entire universe makes sense, always make sure your efforts are going into things that will create engaging adventure, the *raison d’etre* of the campaign. The peripherals that may be interesting to you might not be interesting to your players. This doesn’t mean you cannot design them, but you have limited time and energy and need to make sure you aren’t wasting it. Mapping out an intricate web of alliances and hatreds in the court of the Emperor Ape may be fascinating to you, but if the players aren’t interested in political intrigue that intricate web may never be used in a game, and what a waste that would be.

When you’re not sure the players are going to interact with something, keep it vague and, to some extent fake it when they begin to delve into it. Once you know they’re going to spend some time with something, you can sit down and design the heck out of it.



Designing Dungeons

7

The players have done their part and created characters. Now they need a place to explore. Enter the Treasure Keeper and his or her little world. The world you design can be as complex or simple, as large or small as you like.

If players only want a vast dungeon, then you should design a vast dungeon and very little beyond it. If you all want to recreate an epic quest that spans an entire world and winds up in the myriad alternate planes of existence, then you have lots of hard work ahead of you.

Adventuring is the point of it all, and there are four primary places that adventures are likely to take place. The dungeon was where it all started (and ended for many), and remains the heart and soul of many a fine campaign. Beyond the dungeon is the wilderness, dotted with little pockets of civilization and dangerous ruins to explore. Beyond it all are the other planes of existence, alternate dimensions that make up the multiverse.

The following sections cover all of these places. After these sections there is advice on actually running a game.

Dungeons

There is nothing more ubiquitous in fantasy gaming than the dungeon, a sinister underworld to be explored and plundered. Dungeons come in many different shapes and sizes, from single level mini-dungeons to thirteen-level mega-dungeons with hundreds of chambers to explore. Most dungeons are subterranean, although they need not be located underground.

While a mini-dungeon can be a set of very simple chambers inhabited by fairly mundane dangers – a small complex of caves inhabited by bandits, for example, or the cellars beneath a palace guarded by traps – larger dungeons are usually mythic environments that do not abide reason or logic. They are inhabited by far too many monsters, for example, than should be able to survive in such a small area, the doors close on their own and traps reset on their own, they hold nonsensical bits of architecture, etc. How realistic a dungeon is to be is determined by the Treasure Keeper who designs it. Some enjoy making a very realistic dungeon “ecosystem”, while others go for a completely fantastical setting.

Typical dungeon settings include ruins, cave complexes, magical towers, catacombs, crypts, vaults, fortresses, temples, mines, prisons and extra-planar palaces. The precise nature of the dungeon should determine the likely inhabitants, dangers and rewards to be found within.

Mapping the Dungeon

Dungeon maps are drawn on graph paper. The scale of each square on the grid is usually 10' x 10' or 5' x 5', though you can choose any scale you like.

You want to draw each wall as a thick line, so it shows up easily, and shading around those lines might also help make the dungeon clearer. A set of symbols can be devised to represent doors, stairs, trapdoors, pitfalls, statues, pools, etc.

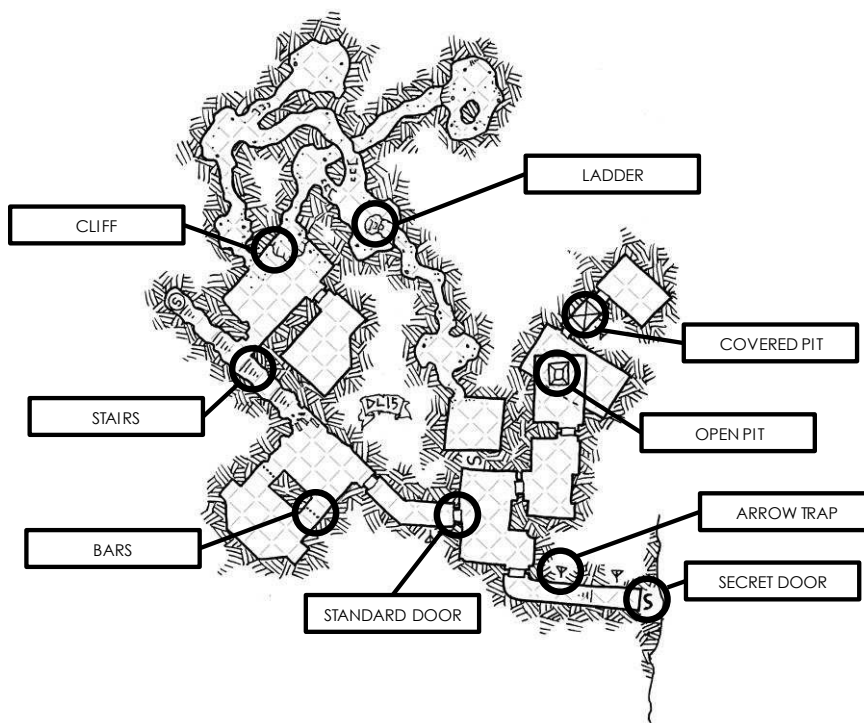

Constructed dungeon walls are drawn as straight lines, while cavern walls are drawn in a zigzag fashion. Some Treasure Keepers make notes directly on a map to help them remember the location of traps, treasures and monsters, while others just key their map, numbering important locations and then making notes on a separate piece of paper as to what those locations contain.

When designing a dungeon, remember to keep it interesting for the players. Use a variety of shapes for chambers, allow some tunnels to weave under other tunnels, etc. Give them a good reason to keep a map.

Don't design a dungeon to be completely linear, with one chamber following the next. Multiple paths to reach the same destination permits adventurers to use their brains to get around hazards they could not overcome with combat or task resolution rolls. It is also a good idea to provide multiple ways to access deeper dungeon levels, rather than a simple staircase from one level to another. Perhaps there is also a chute that can take adventurers directly from level one to level three, or a teleporter that moves people from level five to level two. This not only makes the dungeon more interesting, it also allows higher level characters to bypass levels they have already cleared or that they think might no longer offer sufficient challenges or rewards.

Dungeon Walls

Sometimes, masonry walls divide dungeons into corridors and chambers. Dungeon walls can also be hewn from solid rock, leaving them with a rough, chiseled look, or dungeon walls can be the smooth, unblemished stone of a naturally occurring cave. Dungeon walls are difficult to break down or through, but they're generally easy to climb. Assume the average dungeon wall has about 100 hit points per foot of

thickness, for those trying to tunnel through them with picks (full damage) and hammers (half damage). All other weapons are useless against walls. Naturally, walls made of wood or glass are easier to get through, and walls made of metal are much harder to get through.

Dungeon Floors

Floors may be composed of flagstones, with slime and mold in the cracks and puddles of brackish water, hewn stone covered with loose gravel, dust and other debris, or they might consist of nothing but rubble. Floors may be smooth or uneven, and when uneven present the chance of falling when running or in combat.

Floors that are covered in debris reduce normal speed by half. Slippery floors, whether due to ice, slime or blood, cut speed in half, but might also force explorers to pass save to avoid falling, especially if fighting or running.

Floors need not be confined to a single level. There might be ledges or balconies that are connected by ladders, stairs, poles, magical elevating devices or nothing at all.

In a magical dungeon, floors might be made of unlikely materials, like glass, or they can be composed of force.

Many floors in dungeons contain trapdoors, pressure plates that activate traps, or they might be traps. With the application of just the right amount of weight, or the pull of a lever somewhere nearby, spikes protrude from the floor, gouts of steam or flame shoot up from hidden holes, or the entire floor tilts. These strange floors are sometimes found in an arena, designed to make combats more exciting and deadly. Trappers are monsters that masquerade as normal dungeon floors to catch and eat unwary adventurers.

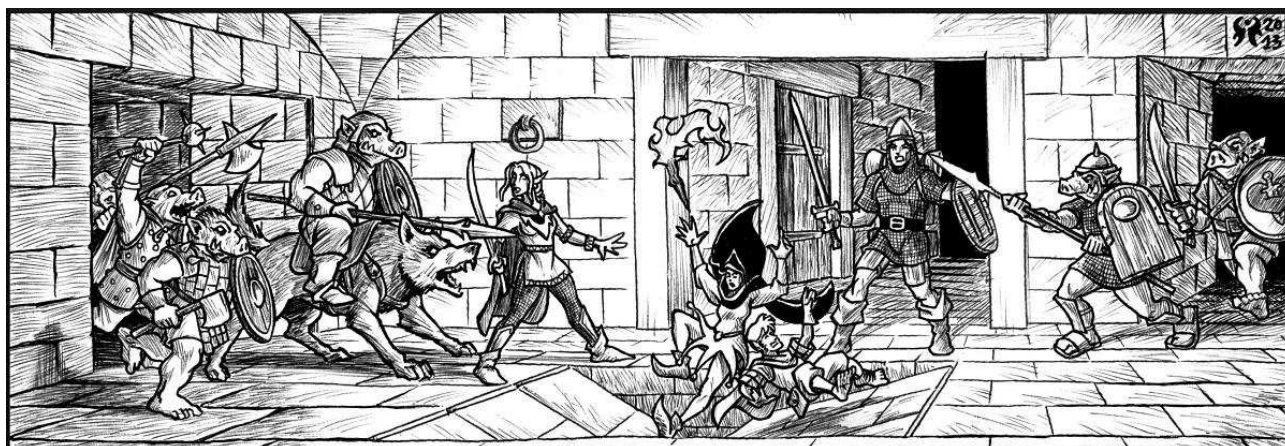

Dungeon Doors

Dungeon doors may be locked, trapped, reinforced, barred, magically sealed, or stuck. All but the weakest characters can eventually knock down a door with a heavy tool such as a sledgehammer, and a number of spells and magic items give characters an easy way around a locked door.

In magical dungeons, locks that are unlocked or picked re-lock themselves after adventurers have passed through. Locks may be simple (requiring an open locks check or key to open) or complex, requiring the players to figure out a combination or method of opening them. Spells such as *wizard lock* can also discourage passage through a door.

Special doors might have pivots instead of hinges. Doors with pivots are usually made of stone and are often quite wide since they pivot in the middle. One can also place the pivot on one side of the door and have the door be thicker at that end and thinner toward the other end so that it opens more like a normal door.

Doors that have been spiked open have a 2 in 6 chance of the spike slipping and the door closing some time after adventurers move on.

Secret Doors

Secret doors are disguised as a bare patch of wall, floor, or ceiling, or a bookcase, fireplace, or fountain. A secret door leads to a passage or room. Someone examining the area finds a secret door, if one exists, on a successful find secret doors check. Elves have a chance to detect a secret door just by casually looking at an area.

Finding a secret door does not necessarily mean finding the way to open it. Many require a special method of opening, such as a hidden button or pressure plate. Secret doors can open like normal doors, or they may pivot, slide, sink, rise, or even lower like a drawbridge to permit access. Magic-users and sorcerers have a spell called *phase door* that allows them to create a magic secret door that only they can use.

Magic Doors

A magic door might speak to explorers, warning them away. It might be protected from harm from weapons or fire or have an improved item saving throw against *disintegrate* and other spells.



A magic door might not lead into the space physically behind it, but instead be a portal to a faraway place or even another plane of existence. Other magic doors might require passwords or special keys to open.

Portcullises

These special doors consist of iron or thick, ironbound, wooden shafts that descend from a recess in the ceiling above an archway. Sometimes a portcullis has crossbars that create a grid. Typically raised by means of a winch or a capstan, a portcullis can be dropped quickly, and the shafts might end in spikes to discourage anyone from standing underneath it (or from attempting to dive under it as it drops). Once it is dropped, a portcullis locks, unless it is so large that no normal person could lift it anyway. In any event, lifting a typical portcullis requires an open doors check.

Dungeon Rooms

Rooms in dungeons vary in shape and size. While many are simple in construction and appearance, particularly interesting rooms have multiple levels joined by stairs, ramps, or ladders, as well as statuary, altars, pits, chasms, bridges, and more. Underground chambers are

prone to collapse, so many rooms, particularly large ones, have arched ceilings or pillars to support the weight of the rock overhead.

Rooms might be used as guard posts, living quarters, workrooms, shrines, temples, vaults, crypts, storage, magical laboratories, libraries, etc.

The tables below can be used to randomly determine dungeon rooms.

Random Dungeon Rooms

d8	Room Shape
1-3	Square or rectangle
4-5	Circular
6	Pentagon, hexagon
7	Cross, L-shape or T-shape
8	Irregular cavern

d6	Room Size
1-3	Small (10' x 20' or 15' x 15' or 15' radius)
4-5	Medium (20' x 40' or 30' x 30' or 30' radius)
6	Large (40' x 80' or 60' x 60' or 60' radius)

d6	Room Exits
1-2	One exit
3-4	Two exits (5% chance one is secret)
5	Three exits (10% chance one is secret)
6	Four exits (15% chance one is secret)

d10	Level Connectors
1-2	Ramps
3-5	Stairs (15% chance they are hidden)
6	Balconies (no connection)
7	Pit
8-9	Ropes or chains
10	Magic (levitation discs, air currents, teleporters)

Room Contents	Chance of Appearing
Monster	50% chance
Trap	30% chance
Trick*	10% chance
Treasure	20% chance

*Magic statue, magic fountain, puzzle, illusion, etc.

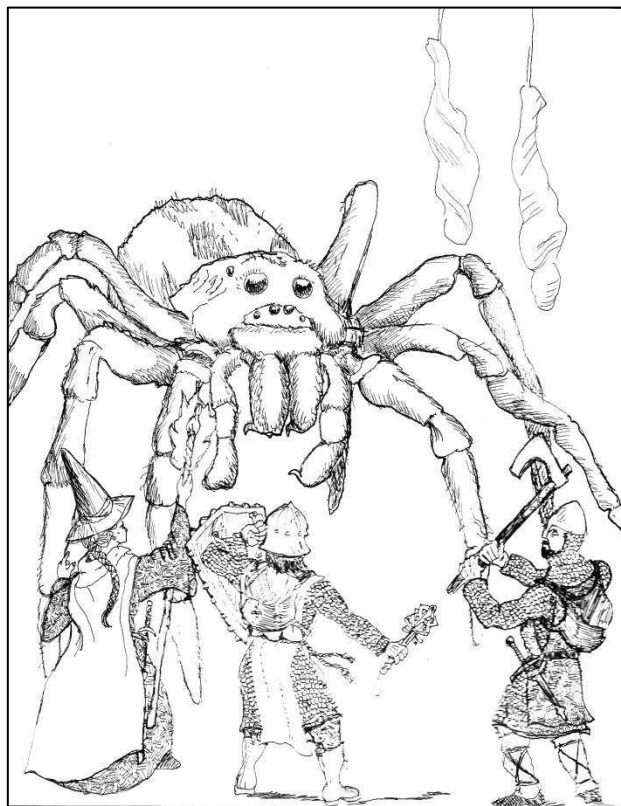

Room Purpose (or Former Purpose)

2d20	Room	2d20	Room
2	Armory	22	Infirmary or hospice
3	Animal pen or kennel	23	Kitchen
4	Bailey (courtyard)	24	Laboratory
5	Barracks or dormitory	25	Library
6	Baths or sauna	26	Monastery
7	Bedchamber	27	Oubliette or prison
8	Brewery	28	Root cellar
9	Buttery or bottlery	29	Sacristy
10	Casemate	30	Scriptorium
11	Cistern or well	31	Sewer
12	Crypt or tomb	32	Storeroom
13	Dock	33	Study
14	Forge or workshop	34	Temple or shrine
15	Foundry	35	Throne room
16	Fuel storage	36	Torture chamber
17	Furnace	37	Treasury
18	Gallery	38	Under construction
19	Garderobe or privy	39	Wardrobe
20	Gatehouse	40	Special Theme
21	Great hall		

Special Room Themes

d8	Theme
1	Fire—Ash, smoke, fire pits, burning walls, obsidian, red
2	Water—Sludge, fountains, pools, well, reservoir, damp, rain, geysers, blue
3	Ice—Freezing, snow, cold winds, white
4	Gas—Sleeping, poison, acidic, fog, clouds, yellow, green
5	Light—Multi-colored, bright, twilight, candles, witch lights
6	Crystal—Reflections, mirrors, glass, gems, facets, vibrations
7	Death—Bone, blood, mold, rot, unholy, quivering, breathing, secretions
8	Sound—Screaming, breathing, moaning, music, song, chanting

Dungeon Corridors

While most corridors just connect rooms, they can also be encounter areas in their own right because of traps, guard patrols, and wandering monsters.

Because dungeon corridors tend to be narrow, offering few movement options, dungeon builders like to place traps in them. In a cramped passageway, there's no way for intruders to move around concealed pits, falling stones, arrow traps, tilting floors, and sliding or rolling rocks that fill the entire passage. Magic traps such as *glyph of warding* are also effective in corridors.

Corridors usually connect rooms in the simplest manner possible. Some dungeon builders, however, design a maze or a labyrinth within the dungeon. This sort of construction is difficult to navigate and, when filled with monsters or traps, forms an effective barrier.

Other Dungeon Features

Stairs

The usual way to connect different levels of a dungeon is with stairs. Straight stairways, spiral staircases or stairwells with multiple landings between flights of stairs are all common in dungeons, as are ramps (sometimes with an incline so slight that it can be difficult to notice). Stairs are important access ways and may be guarded or trapped.

Traps on stairs often cause intruders to slide or fall down to the bottom, where a pit, spikes, a pool of acid, or some other danger awaits.

Bridges

Nothing focuses an adventurer like a bridge. Bridges are natural choke points and extremely dangerous when trapped. They might stretch across a simple chasm, a river, lava, acid, spiked stones or a pit.

A bridge can be a simple wooden plank, while more elaborate bridges can be made of mortared stone with iron supports and side rails. Rope bridges are made of wooden planks suspended from ropes. A rope bridge is convenient because it's portable and can be removed easily. Some bridges have mechanisms that allow them to be extended or retracted.

Chutes and Chimneys

Stairs are not the only way to move up and down in a dungeon. Sometimes a vertical shaft connects levels of a dungeon or links a dungeon with the surface. Chutes are traps that dump characters into a lower area, often a place featuring some dangerous situation with which they must contend.

Pillars and Columns

Pillars and columns supporting ceilings are a common sight in dungeons. The larger the room, the more likely it needs that support. Pillars and columns are often carved, painted, or have things inscribed on them.

Stalagmites and Stalactites

These tapering natural rock formations extend from the floor (stalagmite) or the ceiling (stalactite). Monsters called piercers and darkmantles masquerade as them.

Statue

Experienced adventurers learn to avoid statues in dungeons, for when they aren't animating to attack they are trapped or possessed of weird magical powers. Statues might be carved into columns (i.e. caryatid columns) or walls (i.e. bas-reliefs), or they might be idols and thus under the protection of the deity they are carved to represent.

Tapestry

Elaborately embroidered patterns or scenes on cloth, tapestries hang from the walls of well-appointed dungeon rooms or corridors. Crafty builders take advantage of tapestries to place alcoves, concealed doors, or secret switches behind them.



Pedestal

Anything important on display in a dungeon, from a fabulous treasure to a coffin, might rest atop a pedestal or a dais. Raising the object off the floor focuses attention on it and, in practical terms, keeps it safe from any water or other substance that might seep onto the floor. A pedestal is often trapped to protect whatever sits atop it. It can conceal a secret trapdoor beneath itself or provide a way to reach a door in the ceiling above itself.

Pool

Pools of water collect naturally in low spots in dungeons (a dry dungeon is rare). Pools can also be wells or underground springs, or they can be intentionally created basins, cisterns, and fountains. In any event, water is common in dungeons, harboring sightless fish and aquatic monsters. Pools provide water for dungeon denizens, and thus are important areas for a predator to control, as are watering holes in dry wilderness.

Through accident or by design, a pool can be enchanted. A pool or a fountain may be found that has the ability to bestow beneficial magic on those who drink from it. However, magic pools are just as likely to curse the drinker. Typically, water from a magic pool loses its potency if removed from the pool after an hour or so. Some pools have fountains. Occasionally these are merely decorative, but they often serve as the focus of a trap or the source of a pool's magic.

Most pools contain water, but dungeon pools can hold just about anything, including acid, blood, poison, oil, or magma. And even if a pool holds water, it can be holy or unholy water, salt water, or water tainted with disease.

Elevator

In place of or in addition to stairs, an elevator (really an oversized dumbwaiter) can take inhabitants from one dungeon level to the next. Such an elevator may be mechanical, using gears, pulleys, and winches, or magical, such as a *levitate* spell cast on a movable flat surface. A mechanical elevator might be as small as a platform that holds one character at a time, or as large as an entire room that raises and lowers. A clever builder might design an elevator room that moves up or down without the occupants' knowledge to catch them in a trap, or one that appears to have moved when it actually remained still.

Shifting Stone or Wall

These features can cut off access to a passage or room, trapping adventurers in a dead end or preventing escape out of the dungeon. Shifting walls can force explorers to go down a dangerous path or prevent them from entering a special area. Not all shifting walls need be traps. Stones controlled by pressure plates, counterweights, or a secret lever can shift out of a wall to become a staircase leading to a hidden upper room or secret ledge.

Teleporters

Sometimes useful, sometimes devious, teleporters transport characters to some other location in the dungeon or someplace far away. They can be traps, teleporting the unwary into dangerous situations, or they can be an easy mode of transport for those who built or live in the dungeon, good for bypassing barriers and traps or simply to get around more quickly. Devious dungeon designers might place a teleporter in a room that transports characters to another seemingly identical room so that they don't even know they've been teleported. A detect magic spell provides a clue to the presence of a teleporter, but direct experimentation is the only way to discover where the teleporter leads.

Altars & Idols

Temples, particularly to demons and weird gods, often exist underground. Usually taking the form of a stone block, an altar is the main fixture and central focus of such a temple. Sometimes all the other trappings of the

temple are long gone, lost to theft, age, and decay, but the altar survives. Some altars have traps or powerful magic within them.

Idols are statues, usually accompanied by an altar, and are as dangerous as other statues in a dungeon. Tradition holds that they sometimes made of or covered with precious metals or stones.

Cave-Ins

Cave-ins and collapsing tunnels are extremely dangerous. Characters in the area of a cave-in take 5d6 points of damage, or half that amount if they make a saving throw, and they are subsequently buried. Characters take 1d6 points of damage per minute while buried and can be dug out by friends in about 10 minutes with their bare hands, or 5 with tools.

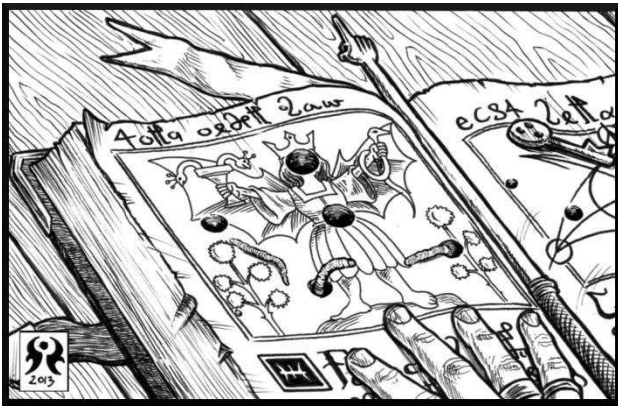

Slimes, Molds, Fungi and Creepy Crawlies

Molds and fungi thrive in a dungeon's damp, dark recesses. While some plants and fungi are monsters and other slimes, molds, and fungi are just normal, innocuous stuff, a few varieties are dangerous dungeon encounters without being actual monsters. For purposes of spells and other special effects, all slimes, molds, and fungi are treated as plants. Characters earn 100 XP for surviving dangerous slimes, molds, fungi and creepy crawlies.

Bookworm

A bookworm is a 1" long gray worm. This miniscule creature is the bane of sages, scholars and wizards, for its primary source of food is the paper that makes up books.

Bookworms cannot harm living creatures, but they burrow through plant-based materials and leather very quickly. Bookworms have a movement rate of 2" and are very hard to detect (5% chance). They can be destroyed with any attack that deals damage to an area.

Magical writings, such as scrolls and spellbooks, are a favorite target of bookworms. Scrolls are destroyed in a single round and any spells contained on it are destroyed as well. A spellbook loses one spell level per round that a bookworm swarm spends burrowing into it.

Green Slime

This dungeon peril is a dangerous variety of normal slime. Green slime devours flesh and organic materials on contact and is even capable of dissolving metal. Bright green, wet, and sticky, it clings to walls, floors, and ceilings in patches, reproducing as it consumes organic matter. It drops from walls and ceilings when it detects movement (and possible food) below. Green slime deals 1d6 points of constitution damage per round while it devours flesh. On the first round of contact, the slime can be scraped off a creature (most likely destroying the scraping device), but after that it must be frozen, burned, or cut away (dealing damage to the victim as well as the slime). Anything that deals cold or fire damage, sunlight, or a *cure disease* spell destroys a patch of green slime. Wood and metal items must pass an item saving throw against green slime. Green slime does not harm stone.

Yellow Mold

If disturbed, this mold bursts forth with a cloud of poisonous spores (Poison IV). All within 10 feet of the mold must save vs. poison. Fire destroys yellow mold, and sunlight renders it dormant.

Brown Mold

Brown mold feeds on warmth, drawing heat from anything around it. It normally comes in patches 5 feet in diameter, and the temperature is always cold in a 30-foot radius around it. Living creatures within 5 feet of it take 3d6 points of cold damage. Fire brought within 5 feet of brown mold causes it to double in size. Cold damage instantly destroys brown mold.

Phosphorescent Fungus

This strange (and non-dangerous) underground fungus grows in clumps that look almost like stunted shrubbery. Dungeon inhabitants cultivate it for food and light. It gives off a soft violet glow that illuminates underground caverns and passages as well as a candle does. Rare patches of fungus illuminate as well as a torch does.

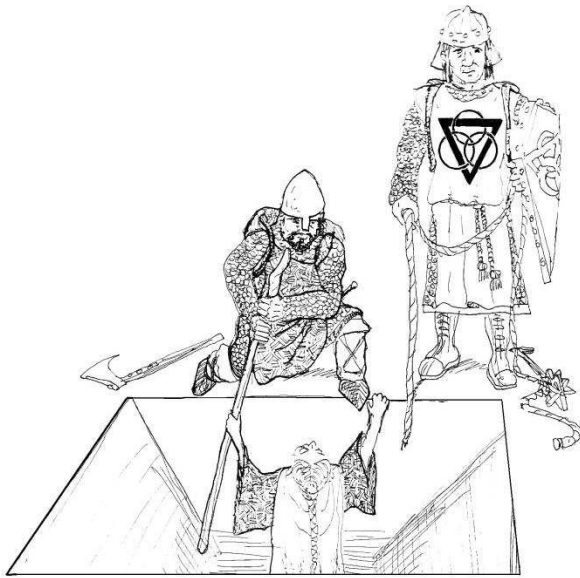

Traps

Cunning, deadly traps are an important part of any dungeon setting. Whether crude devices left by the neighborhood orcs or highly complex, ancient devices left by ancient sorcerers to protect their tombs, avoiding and foiling traps should be part of every delve.

Traps can be as simple or complicated as a Treasure Keeper likes. Simple traps are often present to harass players who forget to search for them or to hamper parties without the ability to remove them. Complex traps exist as puzzles for players, rather than their characters, to solve.

The deadliness of a trap is tied to the level of the dungeon on which it is found. Foiling a trap is worth 100 XP per dungeon level for mechanical traps and 500 XP per dungeon level for magical traps.

d20	Trap Encountered
1-3	Pit trap
4	Pit trap with spikes, monster or other added danger
5-6	Projectile trap (darts, bolts or spears)
7	Projectile trap with poison
8-9	Fusillade trap (darts or bolts)
10	Fusillade trap with poison
11-12	Blade trap (axe, scythe, spear, pendulum, swinging block)
13-14	Poison trap (sleep)
15-16	Poison trap (paralysis)
17	Poison trap (1d6 damage per dungeon level)
18	Poison trap (needle or gas; lethal)
19	Crushing trap (spiked portcullis, rolling boulder, masonry, collapsing column, crushing walls or ceiling)
20	Other trap

Pit Traps

Most pits are 10' to 60' deep. They are often covered with trapdoors that spring open when stepped on. It may take more than one person to trigger a trapdoor. The pit can be spiked or filled with acid, water or monsters. Cost 1,000 gp per 10' to construct.

Projectile Traps

Shoot arrows, bolts or spears when triggered. The poor character in front is hit if they fail a saving throw. If they succeed, characters behind them may have to save. The projectiles can be poisoned. Cost 500 gp to construct.

Fusillade Traps

Shoot masses of tiny darts. All creatures in the area must pass a saving throw to avoid damage (usually 1d4). The darts can be poisoned. Cost 1,000 gp to construct.

Blade Traps

Spring-loaded blades stab or behead. The lead character must pass a saving throw or be damaged. Cost 1,000 gp per 1d6 of damage to construct.

Poison Traps

No thief wants to be the one who shouts, "Poison!" and then keels over dead while picking a lock. Poison traps can deliver any type of poison in a number of ways, but usually from poison needles hidden in locks or other places where they can be sprung by the touch of a finger or poison gas that fills a room.

Poison I and II cost 2,000 gp, Poison III costs 4,000 gp, and Poison IV costs 6,000 gp. The cost is doubled for poison gas.

Crushing Traps

Crushing traps can be bricks or portcullises falling from above, or walls that move inward or ceilings that descend to crush everyone in a room. They can only be saved against if there is a place people can leap. Cost 500 gp per dice of damage they inflict to construct.

Spell Traps

Some spells are traps by design, such as *fire trap*. Others can be turned into traps as though one were creating a magic item. Spell traps can be triggered by such spells as *alarm*, *detect good*, *detect magic*, and *clairsentience*.

Other Traps

Some traps defy categorization, like razor sharp wire strung across a hall or threshold that deal 1d6 points of damage and might cripple adventurers (or chop off a foot or two), boxes of brown mold, spiked chains that spring up to deal damage and tear out throats and rooms that flood with water, poison gas or acid.

Material Weights

What follows are general guidelines for the weight of various substances. If an object is hollow, divide by 4.

Substance	Lb./Cu. Ft.	Substance	Lb./Cu. Ft.
Acid	75	Iron	490
Adamantine	280	Lead	710
Alabaster	170	Malachite	240
Amber	66	Marble	160
Basalt	180	Mithral	170
Brass	530	Platinum	1,300
Brick	90	Quartz	165
Bronze	550	Sandstone	140
Clay	120	Silver	655
Copper	560	Steel	485
Diamond	190	Tin	455
Gold	1,200	Wood	50
Ice	55		

Running Dungeon Adventures

Running a dungeon adventure is like running any other adventure. The TK tells people what they sense, and players tell the TK what they are going to do.

Time Management

Tracking time is especially important in a dungeon setting. Most actions outside of combat can be assumed to take about 10 minutes – progress is slow in a dungeon because they are dark and characters are doing their best not to trigger traps or make their presence known.

When running a dungeon adventure, the TK should do his or her best to keep track of the following:

- When were the torches or lanterns lit, and how much longer do they remain lit?
- The need for periodic breaks. Characters need a short break to eat, drink and do other necessities about once every three hours.



- The duration of spells or special abilities. While many spells and abilities are instant in nature, or only last a few rounds, some last longer and you must keep track of when their effects are coming to an end.
- The onset of disease and some poisons. These are quiet killers, and it is possible their effects are not noticed immediately.
- Checking for periodic wandering monsters.

The best way to keep track of these things is with a spare piece of graph paper. For exploration purposes, assume that each square represents a minute. Ten squares represent a turn, six turns an hour, and so on. You might want to decide on some symbols for when events occur and when they are bound to stop. Perhaps a little drawing of fire or a red dot to represent a torch or lantern being lit and another one further along with a line through it to represent when that object is going to burn out. Likewise, you can highlight when rest periods need to be taken or when saving throws against disease need to be attempted.

Logistics

Dungeon delving is as much about logistics as it is about fighting and exploration, so make sure you are tracking

supplies as they are used (rations, torches, oil, water in water skins, ammunition), and make sure you are tracking how much weight people are carrying and its effect on their movement. It is a good idea to have a list of each character's supplies. They might be careless about keeping track of things; in fact, it is often to their advantage to be careless.

Light

Light is a major problem in dungeons. In general, there is no light other than that brought in by the characters. Make sure you remember how far the character's torches and lanterns illuminate, and don't forget when you have non-humans who can see in darkness. It should be assumed that all natives of a dungeon, even human beings, have developed the ability to see in the dark at least up to 60 feet.

Wandering Monsters

Just as burglars in a museum at night might run into a guard on patrol, adventurers in a dungeon might run into wandering monsters. Wandering monsters are a way to keep players on their toes and to keep the action moving along. Players tend to be protective of their characters, and they have a tendency to over-analyze potentially dangerous situations. If they know that inaction carries a chance of greater danger, they'll keep on the move and keep the game from getting bogged down in planning.

In general, you want to check for wandering monsters once per hour. This is done by rolling 1d6, with a monster encounter occurring on a roll of "1". Treasure Keepers will also want to check for monsters when the players make an undue amount of noise. The sound of combat often draws wandering monsters, as dungeon dwellers are as much scavenger as hunter. A loud trap being set off could also attract wandering monsters, as could an ill-timed argument between adventurers.

The strength of the encounter is up to you. Most TKs create a table of wandering monsters for each level of the dungeon, with the number of monsters encountered keyed to that level. Thus, the first level of a dungeon has wandering monsters appropriate for a first level party. Some TK's make these encounters challenging, while others keep them weak, since they are meant to harass more than destroy. A sample 1st level wandering monster chart may look like this:

d6	Monster (number appearing)
1	Giant Rats (1d6)
2	Kobolds (1d8)
3	Darkmantles (1d4)
4	Fire Beetles (1d6)
5	Chaos Cultists (1st level chaotic clerics) (1d4)
6	Ogre (1)

These monsters may be true wanderers who have no lair or they may be monsters drawn from the lairs present in the dungeon. If you know that a tribe of 100 kobold warriors is present in a dungeon, make sure that kobold warriors killed as wandering monsters are stricken from the total number left in the lair.

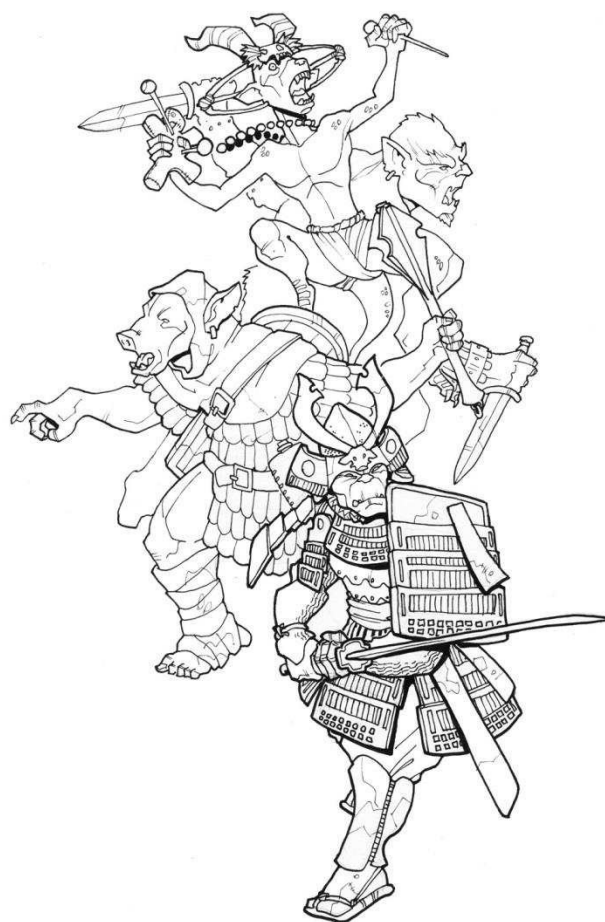

Designing Wilderness

8

Anything outside a dungeon environment or settlement and its immediate environs is classified as wilderness. Wilderness adventurers can be challenging, as the level of the dangers varies widely, and a party of adventurers can easily run into something they are ill prepared to

handle. In the wilderness, adventurers might run into a black bear one day and a green dragon the next.

Drawing a Map

The first step in designing a wilderness is drawing a map. This can be done on normal paper, graph paper or hex paper, noting the scale to help you determine travel times. Many TK's prefer hex paper as it makes running a wilderness adventure as simple as running a dungeon, with the adventurers moving into a hex, exploring it, and then moving on. The best scale of a hex map depends on what you intend to do with it. For a long journey, hexes 20 or 30 miles across might make the most sense. If the wilderness is to be explored in detail, hexes 6 miles wide are adequate. If the wilderness is being cleared to build a stronghold, hexes 1 or 2 miles in diameter are best.

When drawing a map, make note of the environments and land forms, drawing in mountains, hills, woodlands, grasslands, deserts, swamps, rivers, lakes, etc. If using hex paper, you can put a different symbol in each hex to denote the type of terrain that dominates that hex.

Once the geography is set, you can place settlements on the map. Settlements are usually located at intersections of roads, rivers and coastlines. Place the largest settlement first, and then maybe sprinkle smaller settlements in around it. Settlements tend to cluster on a map, leaving large areas of wilderness for adventurers to explore and establish their domains.

Once settlements are placed, you can place other major encounter areas on the map. These include monster lairs, non-human settlements (orc caves, dwarf holds), strongholds of high level adventurers, ancient ruins and dungeons, and natural or supernatural wonders like magic pools, caves that age people, portals into other worlds, mountains of crystal, weird plant life, etc.

Wilderness Dangers

Each time adventurers enter a new hex, or travel 6 miles, roll on the table below to see if they encounter a random danger. It will be up to the TK to work this danger into the narrative of the journey, and if one of these dangers does not make sense – for example falling off a cliff while moving across a flat prairie – just count it as “none”.

D%	Challenge	Effect	Precautions
1	Disease	Save vs. disease	Mosquito netting, boiling water
2	Fall off cliff	Fall 1d6 x 10'	50' rope per person, iron spikes, hammer or pick
3	Poison	Save vs. Type IV poison	Boots or ability to identify plants
4	Heavy snow	Half normal movement Save vs. Cold *	Warm clothing, bedrolls or blankets, flint and tinder, snowshoes or skis
5	Rainstorm	Half movement Ferrous items save vs. rust ** Paper items save vs. damage***	Armor/weapon oil, cases or oilskins for paper items
6	Heat stroke	Fatigued and sickened Save or suffer 1d6 Wis damage	Shade or night travel, double water ration, wear armor lighter than chainmail
7	Lost	Spend one day of travel going nowhere	Map, compass, ranger or wilderness guide, magic ability to tell direction
8	Vermin/ Fungus	Lose 1 day of rations	Keep food in a chest or suspended above the ground, burning incense
9-15	Monster	Roll random encounter	-
16-00	None	-	-

**1d6 points of cold damage, characters crippled for 1d6 days*

***Rusted weapons are -1 to attack; rusted armor is -1 to its base AC*

****Maps are obscured and hard to read; spells from damaged scrolls fail to work 50% of the time; each spell in a soaked spellbook has a 5% chance of being ruined (i.e. removed from the book)*

Each danger is given a list of precautions that can be taken to avoid it. If characters meet these precautionary requirements, they are unharmed by the danger.



Wilderness Encounters

Now that you have an idea of what dwells in your wilderness, you can create random encounter tables. You will want animals and humanoids to dominate the table, making the more wondrous monsters less common and therefore wondrous. One method is to use 3d6 to make a table as follows:

3d6	Monster Encountered
3	Aberration or Construct
4	Outsider or Undead
5	Monster
6	Monster
7	Plant or Monster
8	Animal or Vermin
9	Animal or Vermin
10	Animal or Vermin
11	Humanoid
12	Humanoid
13	Humanoid
14	Monster
15	Monster
16	Giant
17	Fey or Ooze
18	Dragon

It's a good idea to have a table for each region, basing the encounters on the terrain type. You might also want to designate general "challenge levels" for different areas based on their proximity to major settlements. Thus, as

characters move further away from a settlement, they'll know to expect tougher encounters.

A woodland encounter table might look like this:

3d6	Monster (No. Encountered)
3	Will-o'-Wisp (1)
4	Barghest (1)
5	Owlbear (1d4)
6	Aranea (1d6)
7	Assassin Vine (1d4)
8	Spider, Giant (1d12)
9	Wolf (1d4+8)
10	Porcupine, Giant (1d6)
11	Goblin (1d10)
12	Human – Brigand (1d20)
13	Amazon, Red (1d20)
14	Ettercap (1)
15	Bat Monster (1)
16	Ogre (1d8)
17	Dryad (1d8)
18	Dragon – Green (1)

Effect of Terrain on Combat

You can use the following as a guide to the effect of terrain on combat. It is up to the TK to determine which features and conditions apply.

Feature	Effect
Boulder fields	-2 to ranged attacks
Cliffs	Save vs. being knocked off cliff when hit
High winds	-4 to ranged attacks
Ice sheets	Full move and melee combat forces a saving throw to avoid slipping and falling prone
Rain and snow	Visibility halved, -2 to ranged attacks
Rocky ground	Full move forces saving throw to avoid slipping and falling prone
Sand	Half movement
Shallow water	Half movement, -2 to melee attacks
Slopes	When hit in melee combat, save vs. falling down slope for 1d6 points of damage
Tall grass or reeds	Half movement
Underbrush	Half movement
Woods, Light	-2 to ranged attacks
Woods, Heavy	-4 to ranged attacks

Random Wilderness Hexes

Whether you need to stock a wilderness map or the adventurers wander off of the map you already stocked, these random tables might come in handy.

Terrain (Roll 1d10)

When adventurers enter a new hex, look up the column for the terrain they are leaving and roll 1d10 to discover the terrain of the hex they are entering.

Terrain	AQ	GRS	HIL	MT	WDL	WST	WET
Aquatic*	1-5	1	1	1	1	1	1-2
Grassland	—	2-4	2	—	2	2-4	3
Highlands	6	5-6	3-5	2-3	3	5-6	4
Mountains	7	—	6-7	4-7	4	—	—
Woodland	8	7	8	8	5-8	—	5-6
Wasteland	9	8-9	9	9		7-10	—
Wetland	10	10	10	10	9-10	—	7-10

* Includes salt and fresh water

To find out what the hex contains, roll 1d20

d20	Hex Contents
1-2	Monster lair
3-4	Natural wonder (see table below)
5-6	Ruin (1 in 6 leads to a full-scale dungeon)
7	Settlement (see City Adventures below)
8	Stronghold (see table below)
9	Supernatural wonder (see table below)
10-20	Nothing of note

Natural wonders include chasms, gorges, petrified woodlands, craters, geysers, lonely mountains, natural caves, natural springs or hot springs, plateaus (perhaps with a “lost world” atop the plateau), pristine lakes, tar pits, veins of valuable ore and waterfalls.

Supernatural wonders include burial mounds of wights, elf hills (the *glamered* strongholds of the elves), crypts of vampires, pyramids of mummies, cloud islands, floating rocks, ley line nexi where the old gods speak to mankind, weird magnetic fields, mountains of crystal or glass, moving landscapes, positive or negative energy zones, goblin minds, rainbow bridges, rivers of stones or fire, druidic circles and wild magic zones. Imagination is key – not every wonder has to be something the players can explore and conquer. Some are just plain cool to discover, and stoke one’s sense of wonder.

For strongholds, roll d20 to discover the type of stronghold, the class of its ruler and their level.

d20	Type	Ruler	Level
1	Monastery	Monk	1d12+8
2	Hill fort	Barbarian	1d12+8
3	Fort	Assassin	1d12+8
4	Castle	Paladin	1d8+12
5-8	Fortress-temple	Cleric	1d12+8
9-17	Stronghold	Fighter	1d12+8
18-20	Tower	Magic-user	1d12+8

The stronghold’s ruler will have the appropriate number of troops (or really however many you would like) and treasure, and should be prepared to either send the adventurers on a quest or involve them in some wicked machination or scheme ... or if you’re nice, give them a safe place to stay for the night.



Designing Settlements

9

After delving into a dungeon and trekking across the wilderness, players are happy to get their character into a safe, civilized spot on the map. When designing a settlement, you can stick to these basic steps and then build on them as the need arises.

Vistas

The first step in creating a settlement is to describe it. This is more than just an exercise in adjectives and adverbs. To describe a settlement, you need to know a few things about it. Much of what a settlement does is wrapped up in how large it is.

Villages are concerned with fishing, farming, herding or mining. In an economy based on agriculture, villages are where most of the production of raw materials and resources takes place. Villages number 20 to 400 people. Some are free, but most are ruled by a lord.

Manor lords are aristocrats if the manorial village is near a town or city, or high level characters if not.

d6	Village Type
1	Fishermen
2	Herdsman
3	Hunters
4	Miners
5	Peasant Farmers
6	Woodsmen

Most lords demand a toll of $1d6 \times 100$ gp for adventurers to pass through their territory.

Towns are larger than villages, with populations of 500 to 6,000. Towns have markets where goods from the surrounding villages are brought to be traded or turned into manufactured goods. Towns have more artisans in them than villages, and merchants who have traveled as far as the nearest city-state, though rarely beyond. Most towns are surrounded by a wall and towers and might have a nearby keep owned by a viscount, count or a sheriff. The main industry of a town depends on the resources of the villages around it. If most of the villages produce wool, then the town is known for its wool trade.



City-states are surrounded by a web of towns and villages, and are major trading centers that accept goods from across the sea or from overland trade routes, such as the Silk Road. Ancient and medieval cities were not nearly as large as modern cities, and they tended to be much more compact. While a few cities can grow as large as one million people, most range between 7,000 to 600,000 people, averaging 10,000 for small cities and 50,000 for large cities.

Cities are less provincial than towns, and often have many demographic minorities, including populations of elves, dwarves, halflings and half-orcs, not to mention humans from foreign lands. The merchants of the cities are merchant princes, who command large caravans or fleets of cogs and caravels. City-states are commanded by dukes, archdukes, princes and kings, duchesses, archduchesses, princesses and queens.

Once you know what a city does, it should be easier to describe it. Possible interesting features of a settlement include: Walls painted a vivid color or covered with bas-reliefs, canals, tall spires, onion domes, bridges, oddly dressed people, strange mounts or conveyances, etc.

To Map or Not to Map

Given that we have already covered dungeon and wilderness maps, it seems obvious that we should make a map of our settlements. A sketch of the settlement's outline with a few notes on where various important features (king's castle, guard houses, important artisans, sages, important NPC's, the thieves' guild, etc.) are located should suffice, along with the network of major roads and lanes, with names.

A TK can draw a city building by building, either using a random table to determine what one finds in that building or describing each one. However, if a settlement is not going to be used as a major adventure site, this might be more work than it is worth.

A few notes on medieval architecture are probably useful at this point.

Walls and Gates

A typical town wall is a stone wall 5' thick and 30' high. A typical city wall is 10' thick and 40' high. A typical defensive wall on a large city is 15' thick and 50' tall. The walls are crenellated to provide protection for guards. It often has a tunnel and small rooms running through its interior. Large cities often have interior walls as well as surrounding walls, either old walls that the city has outgrown, or walls dividing individual districts from one another.

Towers

Some city walls are adorned with towers set at irregular intervals. Few cities have enough guards to keep someone constantly stationed at every tower, unless the city is expecting attack from outside.

Watch towers are usually 10' higher than the wall they adjoin and their diameter is twice the thickness of the

wall. Arrow slits pierce the upper stories of a tower, and the top is crenellated in the manner of the city walls. In a small tower a ladder connect the tower's stories and the roof. In a larger tower, stairs serve that purpose.

Heavy wooden doors reinforced with iron and bearing good locks block entry to a tower, unless the tower is in regular use. As a rule, the captain of the guard keeps the key to the tower on his or her person, and a second copy is in the city's inner fortress or barracks.

Gates

A typical city gate is a gatehouse with an inner and outer portcullis and murder holes above the space between them. In towns, the primary entry is through iron double doors set into the city wall. Gates are open during the day and locked or barred at night. One gate might let in travelers after sunset and is staffed by guards who open it for someone who seems honest, presents proper papers, or offers a large enough bribe (depending on the city and the guards).

City Streets

Typical city streets are narrow. Most average 15' wide, while alleys range from 5' to 10' wide. Cities that are planned or have suffered a major fire that allowed authorities to construct new roads through formerly crowded areas might have a few larger streets.

These main roads are 20' to 30' wide, offering room for wagons to pass each other, with additional space for pedestrians. Streets are often full of people going about their daily lives. If crowds see something dangerous, they move away at a speed of 30' per round.

Sewers

To begin with, actual ancient and medieval sewers are rare. Fantasy towns and cities, on the other hand, might have a sewer system because they make a great place for adventures. To get into these sewers, characters can open a grate and jump down about 6' to 10'. Sewers are built like dungeons, except that they always have floors that are slippery with water and filth. Sewers are also similar to dungeons in terms of creatures liable to be encountered therein. Some cities were built atop the ruins of older civilizations, so their sewers sometimes lead to treasures and dangers from a bygone age. Each day spent in a sewer should carry with it a small chance of contracting a disease.

City Buildings

Most city buildings fall into three categories. The majority of buildings in the city are two to five stories high, built side by side to form long rows that form squares separated by secondary or main streets and with courtyards or green spaces in the middle. These row houses have businesses on the ground floor, with offices or living quarters above.

Inns, successful businesses, large warehouses, millers, tanners and other businesses that require extra space are generally large, freestanding buildings with up to five stories, forming squares around courtyards.

Small residences, shops, warehouses, or storage sheds are simple one-story wooden buildings, especially if they are in poor neighborhoods.

Most city buildings are made of a combination of stone or clay brick (on the lower one or two stories) and timber (for the upper stories, interior walls, and floors). Roofs are a mixture of boards, thatch, and slates, sealed with pitch. A typical lower-story wall is 1 foot thick. Upper-story walls are 6 inches thick. Exterior doors on most buildings are wooden doors that are kept locked.

Goods for Sale

The size of a settlement should have some impact on how easy it is to find various artisans and professionals. To keep things easy, the following lists the types of hirelings commonly found in different sized settlements. Towns contain all the hirelings to be found in villages, and cities contain all the hirelings one can find in towns and villages.

There is a 10% chance that a settlement has a hireling that would normally be found in a settlement one size category larger, and a 1% chance of a hireling that would normally be found in a settlement two sizes larger.

Village	Bearers, blacksmiths, carpenters, cartwrights, men-at-arms**, millers, potters, tanners, thatchers, weavers, taverns
Town	Animal trainers, arkwrights, armorers, bakers, bowyers, brewers, chandlers, cobblers, coopers, dyers, entertainers, furriers, glassblowers, inns, leather-workers, locksmiths, masons, money-lenders, priests, rogues, rope makers, scribes, tailors, tanners, vintners, woodcarvers, NPCs*
City	Alchemists, assassins, bookbinders, cartographers, engineers, jewelers, sages, ship-wrights, thieves

**NPC refers to non-player characters with class levels. You can use the "Finding Henchmen" tables to determine the exact type found.*

***Men-at-arms in villages are employed by the local lord or form the local constabulary. In towns and cities, there are mercenaries for hire.*

Settlements are rarely home to high level adventurers, since those folk prefer the freedom and power of the strongholds they have established on the edge of civilization. Moreover, rulers have little desire for powerful rivals close to home, preferring to put them on the borderlands where they can fight monsters. Low to mid-level adventurers may settle in city-states, taking jobs with the government, opening taverns or investing in (or leading) mercantile companies. In practice, this means that one will rarely find NPC's higher than 6th level in a city-state. Consequently, spells higher than 3rd level are difficult to come by in city-states. If adventurers seek powerful spells or the creation of magic items, they must venture into the wilderness.

Most city dwellers are 0 HD humans or demi-humans. The only high-level NPC's common to city-states are its high priest (a cleric or druid) and the leader of its criminal underworld (a thief or assassin).

The rest of a city's citizens are either peasants, burghers (artisans and merchants) or aristocrats. The artisans that adventurers deal with are masters that own their shops. A master might be assisted by a journeyman and one or two apprentices. A few artisans are classed as "grand masters" capable of making items of extraordinary quality. Artisans belong to guilds that control pricing and get the word out about deadbeat or abusive adventurers, so players had best take care.

It is important for players to understand how a medieval artisan worked. Artisans did not generally produce surpluses of goods that could be purchased "off the rack". While the apprentices and journeymen might spend their day making cheap items (less than a gold piece in value) that were in constant demand, masters make more valuable items to order. This takes time.

Social Classes

There are three social classes represented in a fantasy medieval society, the aristocrats, burghers and peasants.

Aristocrats are 1 to 2 percent of the population. They include royalty, nobility, knights and dames. 1 in 100 aristocrats have class levels, typically cleric, fighter, magic-user or paladin. Aristocrats earn anywhere from 600 gp to 10,000 gp a year (1d20 gp per day).

Burghers, or townsmen, are the middle class. They make up about 10 to 20 percent of the population and include merchants, guild masters, officials, abbots, priests, lawyers, scholars, explorers, officers, inn and tavern keepers and artisans. 1 in 1,000 burghers have class levels, those folks typically being retired adventurers. Burghers earn about 30 gp to 200 gp per year (1d10 x 10 sp per day).

Peasants represent most of the rest of a population. They include servants, tutors, farmers, herdsmen, fishermen, men-at-arms and apprentices. 1 in 10,000 has class levels. They earn from 10 to 20 gp per year (1d6 cp/day).

The underclass represents 5 to 10 percent of the population. They include actors, assassins, beggars, outlaws, peddlers, prisoners, rebels, runaway serfs, strolling minstrels, thieves, tinkers and vagabonds. 1 in 1,000 have class levels, usually as assassins, bards, barbarians and thieves. Their earnings vary widely.

Rulers

Most campaigns assume a pseudo-feudal system of organization, with kings on the top and dukes, counts and barons beneath them in a somewhat loose hierarchy. Family ties mean everything in such a society, and people are loath to allow folks to do anything other than follow in their father or mother's footsteps. Adventurers and other rogues live outside such a system, and so are considered something of a menace. The townsfolk like your money, but they don't like you.

Naturally, other forms of government are possible, and offer a chance to differentiate cities from one another. A few possible forms of realistic and fantastic rulers follow:

Democracy: Rule by the majority

Despotism: Rule by one person with absolute authority

Feudalism: Rule by warrior nobility based on obligations between lords and vassals

Kleptocracy: Rule by thieves

Kritarchy: Rule by judges

Monarchy: Rule by a single person who is either absolute in power, or must govern within established laws

Monstrous: Rule by powerful monsters like angels, demons, devils, sphinxes, titans or vampires

Magocracy: Rule by magic-users and sorcerers

Oligarchy: Rule by a small group of powerful people

Plutocracy: Rule by the wealthy, either merchant princes or major land owners

Republic: Rule of law, often by elected officials

Theocracy: Rule by clerics and druids

Titles

One way to make different settlements and countries memorable is to vary the titles of their rulers. Here are a few ideas:

Imperial Titles: Emperor/empress, imperator (Rome), basileus (Byzantium), samraat (India), king of kings, shahanshah (Persia), khagan (Mongols), huang (China)

High Royal Titles: High king/queen, maharaja (India), padishah (Persia), pharaoh (Egypt), anax (Greece), ard ri (Gaelic), bretwalda (Saxon), lamane (W. Africa)

Royal Titles: King/queen, rex (Rome), raja/rani (India), ri (Gaelic), di (China), khan (Mongol), shah/shahbanu (India), sultan (Araby), malik (Araby), tuanku (Malaysia), lakan/diyan (Philippines), teigne (West Africa)

High Noble Titles: Grand prince/princess, gun (China), grand duke/duchess, viceroy/vicereine, archduke/duchess, prince/princess, princeps (Rome), morza (Mongol), despot (Greece), elector (Holy Roman Empire), duke/duchess, gong (China), emir (Araby), bey (Turks), buumi (West Africa), poobah (opera)

Religious Titles: Pope/popess, caliph, saltigue, patriarch/matriarch

Noble Titles: Marquis/marquessa, hou (China), count (earl)/countess, bo (China), viscount/viscountess, zi (China), baron/Baroness, nan (China)

Aristocrat Titles: Baronet, dominus, vidame, seigneur, knight, hidalgo, nobile, junker, esquire



The Long Arm of the Law

Villages are protected by the men-at-arms of the local lord or lady, or, if there is no local lord or lady, a militia of yeomen armed with pole-lanterns, billhooks or clubs and leather armor. Towns and cities are protected by larger armies of men-at-arms. The walls are guarded by archers or crossbowmen. Assume one man-at-arms per 150 feet of wall and another 1d10 per tower.

Watch patrols are encountered randomly in the streets, but there are always 1d6 such guards in markets and around important buildings. These guardsmen wear leather armor and carry shields, clubs (for subduing criminals) and short swords (for more serious dangers).

Medieval towns do not have modern-style police forces, these being formed in the 19th century. By the 18th century, thief-takers were being hired as private police to bring criminals to justice, and a fantasy game might use such characters. Otherwise, people either took the law into their own hands, or called on the local sheriff or constable and his watch to seize a criminal and bring them to the local lord for trial. Manorial courts often used a jury system, while royal courts preferred to establish guilt using ordeal by fire, water or combat. A settlement usually has one lawman per 200 citizens.

In a medieval milieu, clerics might be subject only to ecclesiastical law (i.e. the law of their temple), and thus are tried by high priests, abbots, bishops and the like and not secular authorities.

Criminals were rarely locked in jails or dungeons. Rather, they were chained or bound and kept wherever it was handy, possibly in a pillory. Punishments included the levying of "guilt money", whippings and lashings, being locked in a pillory, mutilation or, if the crime was dire enough, a visit to the gallows, chopping block or being burned at the stake.

The Dogs of War

A settlement's soldiery consists of one squadron of men-at-arms (10 men-at-arms) per 1,000 people, and one squadron of militia (10 commoners) per 100 people plus the appropriate leaders. Thus, a city of 10,000 has 10 squadrons of men-at-arms and 100 squadrons of militia. You can determine the armaments of these squadrons randomly using the Finding Henchmen tables in Chapter 3.

Notable Citizens

The only citizens you need to detail when designing a settlement are those that are sought out by the adventurers or that often come into contact or conflict with them. This includes alchemists for potions and spells, armorers for armor and weapons, bowyers for ranged weapons, barbers for gossip and healing, priests for healing and holy water, sages for information and spells, moneylenders for high interest loans (20% was not uncommon in the ancient world, and they always demand a security deposit), the captain of the guard for the inevitable tavern brawl, and aristocrats for their patronage. It is best to detail only one or two of each since reoccurring NPC's are more fun for the players.

Random Settlement Encounters

Random encounters should only be diced for at night, or when adventurers have left the main streets for the back alleys. There is a 1 in 6 chance per hour, under these conditions, of an encounter.

Roll	Main Streets (d10)	Back Streets (d10)	At Night (d12)
1	Building fire	Chaos cultists	Chaos cultists
2	Chamber pot	Charlatan	Ghoul
3	Clerical procession	Giant rats	Giant rats
4	Guards	Guards	Night hag
5	Mage duel	Magic-users	Press gang
6	Mob violence	Prostitute	Prostitute
7	Noble procession	Rakes	Rakes
8	Pick pockets	Thieves	Succubus
9	Runaway horses	Thugs	Thieves
10	Tax collector	Vicious dogs	Thugs
11	-	-	Vampire
12	-	-	Wererat

Building Fire: A building is engulfed in flames, causing a panic. For 1d4+1 rounds, the adventures must pass a saving throw each round or be knocked prone and trampled for 1d4 points of damage unless they flee. There is a 10% chance of a person being trapped in the building. Pick pockets work the crowd (see below).

Chamber Pot: A random adventurer is struck by effluence from a chamber pot that has been emptied from a window. If that seems a bit too nasty, make it garbage. Either way, the adventurer suffers a -1 reaction penalty until they clean themselves up.



Chaos Cultists: A gang of 1d6 chaos cultists lurks in the shadows, seeking victims to sacrifice. Most cultists are priests (see Henchmen), but there is a 1 in 6 chance of one cultist being a Chaotic cleric (level 1d6) and the group's leader. They wear ring mail under their robes and are armed with footman's maces and plenty of rope.

Charlatan: An illusionist (level 1d6+1) attempts to sell some worthless tonics or powders to the crowd. His toady is a thief or bard of half the level of the illusionist.

Clerical Procession: A procession of Lawful clerics or Neutral druids is making its way down the street. The procession consists of a high priest (cleric level 1d6+1) and 1d6+4 lesser priests. They carry a portable idol or large holy symbol on a pole and might be casting blessings, selling holy symbols, holy water or indulgences, or giving alms to the poor.

Ghoul: A pack of 1d6 ghouls ambushes the adventurers. Alternatively, the adventurers might come upon the ghouls attacking a victim.

Giant Rats: A pack of 2d6 giant rats emerges from piles of garbage to attack the adventurers.

Guards: During daytime hours, 1d6+1 men-at-arms use their official position to harass and annoy the adventurers, and maybe shake them down for a bribe. At night, 1d4+4 men-at-arms led by a fighter (level 1d6) are on patrol. There is a 1 in 6 chance they are accompanied by a cleric or magic-user (level 1d4).

Mage Duel: A crowd has gathered to witness two magic-users (roll 1d10 to determine their levels – keep them

close) have a magic duel. Pick pockets will work the crowd (see pick pockets below).

Magic-User: A powerful magic-user (level 1d4+6) and his 1d4+1 apprentices (magic-users level 1) are looking for victims for his experiments, out shopping for laboratory equipment or ingredients or are on some other weird, mystic errand.

Mob Violence: Two factions (rival families, cults or guilds) have come to blows. Each faction consists of 6d6 people armed with clubs. People within 60 feet of the epicenter of the violence must make a saving throw each round or be attacked by 1d3 combatants.

Night Hag: A night hag is on an infernal errand.

Noble Procession: A nobleman or woman (or couple) is making their way down the street. Roll 1d6 for their rank: 1-3 Knight; 4-5 Nobility; 6 Royalty. Multiply this roll by 2 to determine the number of courtiers with them, and by 4 to determine the number of men-at-arms accompanying them. Half are heavy infantry, the other half are heavy cavalry.

Pick Pocket: A gang of 1d6 rogues or a single thief (level 1d6+2) targets a random adventurer.

Press Gang: A gang of 1d4+4 sailors (treat as men-at-arms with no armor and armed with clubs) led by their first mate (fighter or duelist level 1d6) are looking for new recruits to press into service.

Prostitute: A man or woman of the evening is plying their trade here. Roll 2d6+6 for their charisma. They charge their charisma x 10 gp for a night's entertainment, and pass on an embarrassing condition if their customer fails a saving throw vs. disease.

Rakes: A gang of drunken aristocrats armed with padded armor, rapiers and daggers is looking for trouble. There is a 1 in 6 chance they are led by a duelist (level 1d6). They are drunk and hostile.

Runaway Horses: 1d4 heavy horses (or some other large domestic animal) have gone wild and bear down on the adventurers, threatening to trample them and possibly a helpless old man or woman or child. If there is more than one horse, they are hooked up to a wagon laden with goods.

Succubus: A succubus looks for prey, masquerading as a normal human.

Tax Collector: A tax collector (an aristocrat) and his 1d4+2 men-at-arms (light infantry) are shaking down the citizens for donations to the community chest. They are always looking out for wealthy adventurers.

Thieves: A gang of 1d6 rogues is plotting a caper, in the middle of robbing a building or fleeing the scene of the crime. There is a 1 in 6 chance that they are led by a thief (level 1d6).

Thugs: A pack of 1d6 thugs is either plotting violence, in the act of murdering a victim or fleeing from a scene. Most thugs are rogues (see Henchmen), but there is a 1 in 6 chance of an assassin (level 1d6) being present as their leader. They appear as figures in hooded black cloaks and are armed with poisoned daggers.

Vampire: A vampire is stalking the streets in search of prey. If the party is powerful enough, the vampire might be accompanied by 1d4 of his spawn with half as many hit dice as their master.

Vicious Dogs: A pack of 2d4 stray dogs look for food.

Wererat: A pack of 1d6 wererats are on the hunt.

Random Settlements

You can use the following tables to generate settlements.

Size

d%	Settlement	Population	Pop. Roll
01-40	Small Village	20-90	1d8+1 x 10
41-60	Large Village	100-400	2d4 x 50
61-80	Small Town	500-1,000	1d6+4 x 100
81-90	Large Town	1,000-6,000	2d6 x 500
91-95	Small City	7,000-10,000	1d4+6 x 1,000
95-99	Large City	10,000-60,000	2d6 x 5,000
00	Metropolis	60,000-600,000	10d10 x 6,000

Settlement Ruler

d%	Ruler
01-50	Normal human (usually merchant prince or noble)
51-70	Specialist human (priest, sage, etc.)
71-84	Minor NPC (class level 1d6)
85-94	Major NPC (class level 1d6+6)
95-99	Extraordinary NPC (class level 1d6+12)
00	Monster (CL 6+) (1% chance of rule by a demigod)

The locals are known for ...

Roll on this table as many times as you like.

d%	Result
01	Their domesticated monsters
02	Their dour religion
03	Their forbiddance of alcohol
04	Their forbiddance of dancing
05	Their forbiddance of fighting
06	Their frequent and boisterous festivals
07	Their hatred of magic
08	Their lack of clothing
09	Their lack of eye contact
10	Their love of a good fight
11	Their love of gambling
12	Their matriarchal society
13	Their outlandish costumes
14	Their sacred animals
15	Their separation of the sexes
16	Their superstitions
17	Their xenophobia
18	Their bravery or cowardice
19	Their deceitful or honest behavior
20	Their dedication to hard work or sloth
21	Their jovial or somber moods
22	Their lanky or stout shapes
23	Their loutish or friendly manner
24	Their militant or pacifistic attitudes
25	Their pious or licentious behavior
26	Their ragged or foppish appearance
27	Their swarthy or fair skin
28	Their barbarian hero (barbarian level 1d4+4)
29	Their charlatan (illusionist level 1d4+4)
30	Their constable (paladin level 1d4+3)
31	Their cunning man or wise woman (sorcerer level 1d4+4)
32	Their fencing master (duelist level 1d4+6)
33	Their fighting abbot (monk level 1d4+5)
34	Their fighting bishop (Lawful cleric level 1d4+4)
35	Their friendly neighborhood druid (level 1d4+4)
36	Their guard captain (fighter level 1d4+4)
37	Their local ranger (ranger level 1d4+4)
38	Their master alchemist (adept level 1d4+1)
39	Their master animal trainer
40	Their master armorer

41 Their master artisan (TK's choice)
 42 Their master bowyer
 43 Their master engineer
 44 Their master jeweler
 45 Their local mercenaries (1d6 squads led by sergeant)
 46 Their local minstrel (bard level 1d4+4)
 47 Their local prelate (adept level 1d4+1; has 2d6 acolytes)
 48 Their magic-user (level 1d4+4)
 49 Their master sage (adept level 1d4+1)
 50 Their master thieves' guild (thief level 1d4+6 plus followers)
 51 Their spy ring (assassin level 1d4+6 plus followers)
 52 Their bazaar and black market
 53 Their canals
 54 Their college (3d6 sages)
 55 Their dwarven quarter (5% of the population)
 56 Their elven quarter (5% of the population)
 57 Their fencing academy (led by duelist level 1d4+3)
 58 Their foreign quarter (5% of the population)
 59 Their fortified harbor
 60 Their gnomish quarter (5% of the population)
 61 Their goblin quarter (5% of the population)
 62 Their halfling quarter (5% of the population)
 63 Their haunted manor (spectre, wraith or ghost)
 64 Their impenetrable keep
 65 Their magnificent gardens
 66 Their monastery (led by monk level 1d4+3)
 67 Their triumphal monuments
 68 Their smuggler tunnels
 69 Their ziggurat/cathedral/grand temple
 70 Their fine beer, wine or spirits
 71 Their fine breads and pastries
 72 Their fine orchards
 73 Their fine vegetables
 74 Their iron foundries
 75 Their legendary livestock
 76 Their mercantile guild (3d6 master merchants)
 77 Their mines (base metals)
 78 Their mines (precious metals)
 79 Their mines (precious stones)
 80 Their quarries
 81 Their rare herbs
 82 Their rare spices
 83 Their skill at smithing
 84 Their skill at masonry

85 Their skill at weaving
 86 Their skill at woodworking
 87 Their slave markets
 88 Their valuable timber
 89 Their wool industry
 90 Their awful weather
 91 Their bandit problem
 92 Their chaos cult (led by cleric level 1d4+4)
 93 Their doppelganger problem (1d4+1 have infiltrated the halls of power)
 94 Their extensive monster-infested dungeons under the settlement
 95 Their ghoul problem
 96 Their local monster (challenge level 1d6+4)
 97 Their rat infestation
 98 Their vampire problem
 99 Their visitations from beyond
 00 Their werewolf problem

Urban Adventure Hooks

Settlements, especially larger settlements, can be the source of many out-of-the-ordinary adventures. Some of the following plot hooks might get the ball rolling:

- PC's are caught between rival factions vying for power
- PC's catch wind of a magic-user or alchemist building a flesh golem or conducting dangerous experiments
- A local falls in love with a character; the local might be married to a jealous spouse, or the child of a powerful person, even royalty
- The settlement is threatened by bandits, monsters or an enemy army; the characters might be the settlement's only chance for survival
- The settlement is subject to a natural disaster – this could be a chance to save people or to pull off a heist
- A plague brings the walking dead
- Characters have trouble with local thieves or assassins
- Characters are invited to participate in a tournament; the winner gets to slay a monster menacing the kingdom
- Characters are recruited by a local noble for a routine errand that turns out to be anything but routine
- Characters run afoul of the local tax collector, who wants a portion of their loot

Other Planes

10

A “plane” is a self-contained reality that is linked to other realities. The cosmos in which the adventurers dwell is such a plane, and is usually called The Material Plane. Other planes might represent such places as Hell, Heaven, Asgard, Fairyland, or anything else you can imagine. Each plane is its own universe with its own set of natural laws.

Planes can be categorized as one of the following types: Material Planes, Transitive Planes, Inner Planes, Outer Planes, and Demiplanes.

Material Plane

A Material Plane tends to be the most like our reality of all the planes and operates under the same set of natural laws (or something similar). This is the default plane for most adventures.

Transitive Planes

These three planes have one important thing in common: Each is used to get from one place to another. The Astral Plane is a conduit to all other planes, while the Ethereal Plane and the Shadow Plane both serve as means of transportation within the Material Plane to which they are connected. These planes have the strongest regular interaction with the Material Plane and are accessible by magic. They have native inhabitants.

Elemental Planes

These six planes are manifestations of the basic building blocks of the universe. Each is made up of a single type of energy or elemental substance that overwhelms all other such energies or substances. The natives of a particular Elemental Plane are composed of the same energy or element as that plane.

Outer Planes

Deities live on the Outer Planes, as do creatures such as angels, celestials, demons and devils. Each of the Outer Planes has an alignment, representing a particular moral or ethical outlook, and the natives of each plane tend to behave in agreement with that plane’s alignment. The Outer Planes are also the final resting place of souls from

the Material Plane, whether that final rest takes the form of calm introspection or eternal damnation.

Demiplanes

This category covers all extradimensional spaces that function like planes but have measurable size and limited access. Other kinds of planes are theoretically infinite in size, but a demiplane might be only a few hundred feet across.

Planar Traits

Each plane of existence has its own properties—the natural laws of its universe. Planar traits are broken down into a number of general areas. All planes have the following kinds of traits.

Physical Traits: These traits determine the physical and natural laws of the plane, including gravity and time.

Elemental and Energy Traits: These traits determine the dominance of particular elements or energies.

Alignment Traits: Just as characters may be Lawful, Neutral or Chaotic, many planes are tied to a particular alignment or philosophy.

Magic Traits: Magic works differently from plane to plane, and magic traits set the boundaries for what it can and cannot do.

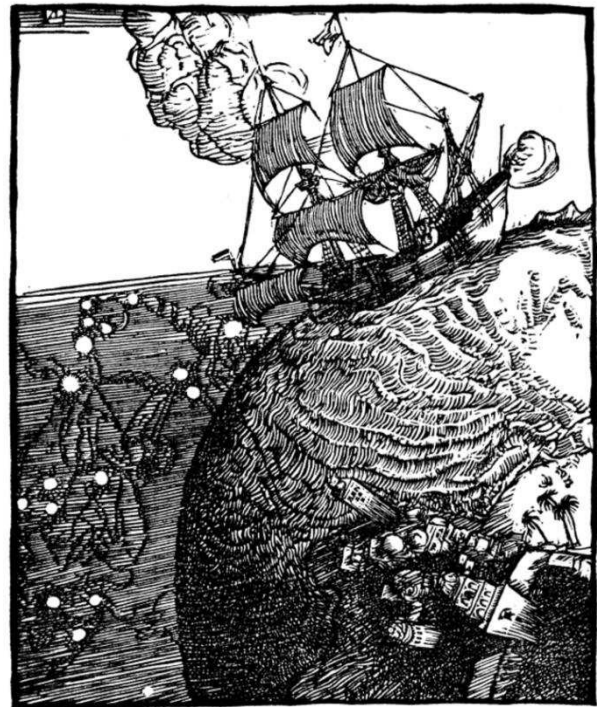

Physical Traits

The two most important natural laws set by physical traits are how gravity works and how time passes. Other physical traits pertain to the size and shape of a plane and how easily a plane's nature can be altered.

Gravity: The direction of gravity's pull on a plane may be unusual or random.

Normal: No special effects.

Heavy: Item weights doubled, weapon ranges halved, attack rolls at -2 for non-natives, falling damage doubled.

Light: Item weights halved, weapon ranges doubled, attack rolls at -2 for non-natives, falling damage halved.

None: Individuals float in space.

Objective: Normal gravity, but the direction is not the traditional "down" towards the ground.

Subjective: Normal gravity, but each individual chooses the direction of gravity's pull; unattended items exist in no gravity.

Time: The rate of time's passage can vary on different planes, though it remains constant within any particular plane. Time is always subjective for the viewer. The same subjectivity applies to various planes. Travelers may discover that they'll pick up or lose time while moving among the planes, but from their point of view, time always passes naturally. A plane in which a century passes in a Material Plane day has a major impact on a campaign, so do not use such planes lightly.

Normal: No special effects.

Timeless: Time passes, but the effects are diminished.

Flowing: Time flows more quickly or slowly on the plane than in normal time.

Erratic: Time slows down and speeds up.

d10	Time on Material Plane	Time on Erratic Plain
1	1 day	1 round
2-4	1 day	1 hour
5-6	1 day	1 day
7-9	1 hour	1 day
10	1 round	1 day

Shape and Size: Planes come in a variety of sizes and shapes. Some planes are infinite, or at least so large that they may as well be infinite. Planes can also be self-

contained, meaning the borders wrap in on themselves so that one always ends up in the same spot eventually if they walk in a single direction.

Elemental and Energy Traits

Four basic elements and two types of energy together make up everything in the fantasy cosmos. The elements are air, earth, fire and water. The energies are positive (life) and negative (entropy).

The Material Plane reflects a balancing of those elements and energies; all are found there. Each of the Elemental Planes is dominated by one element or type of energy. Other planes may show off various aspects of these elemental traits. Many planes have no elemental or energy traits; these traits are noted in a plane's description only when they are present.

Air planes are mostly open space. Planes with this trait have just a few bits of floating stone or other elements. They usually have a breathable atmosphere, though such a plane may include clouds of acidic or toxic gas. Creatures of the earth subtype are uncomfortable on air-dominant planes because they have little or no natural earth to connect with. They take no actual damage, however, from this abundance of air.

Earth planes are mostly solid matter. Travelers who arrive on such a plane run the risk of suffocation if they do not reach a cavern or other pocket within the earth. Worse yet, individuals without the ability to burrow are entombed in the earth and must dig their way out (5 feet per turn). Air elemental creatures are uncomfortable on earth dominant planes because these planes are tight and claustrophobic to them, but they suffer no inconvenience beyond having difficulty moving.

Fire planes are composed of flames that burn without consuming their fuel source. Fire-dominant planes are extremely hostile to Material Plane creatures, and those without resistance or immunity to fire are soon immolated. Unprotected flammable materials catch fire immediately, and those wearing unprotected flammable clothing catch on fire. In addition, individuals take 3d6 points of fire damage every round they spend on a fire plane. Water elemental creatures are extremely uncomfortable on these planes. Creatures that are made of water take 6d6 points of damage each round.

Water planes are mostly liquid. Visitors who cannot breathe water or who do not soon reach a pocket of air drown. Elemental fire creatures are extremely un-

comfortable on water-dominant planes. Those made of fire take 6d6 points of damage each round.

Positive planes are characterized by an abundance of positive energy, and thus life. Positive energy is the key ingredient in spells that heal damage and create life. The two kinds of positive-dominant traits are minor positive-dominant and major positive-dominant.

A minor positive-dominant plane is a riotous explosion of life in all its forms. Colors are brighter, fires are hotter, noises are louder, and sensations are more intense. All individuals heal 2 hit points per round.

Major positive-dominant planes go even further. A creature on a major positive-dominant plane must make a saving throw to avoid being blinded for 10 rounds by the brilliance of the surroundings. Simply being on the plane grants the regeneration ability. Creatures at full hit points gain 1d6 additional hit points per round. These temporary hit points fade 1d20 rounds after the creature leaves the major positive-dominant plane. However, a creature must make a saving throw each round that its temporary hit points exceed its normal hit point total. Failing this saving throw causes the creature to explode in a riot of colors, killing it.

Negative planes are vast, empty reaches that suck the life out of the travelers who cross them. They tend to be lonely, haunted planes, drained of color and filled with winds bearing the soft moans of those who died within them. Negative energy is anathema to life, and spells that inflict wounds, drain energy or inflict instant death use negative energy to do so.

Negative-dominant planes can also be either minor or major. On minor negative planes, living creatures take 1d6 points of damage per round. At 0 hit points or lower, they crumble into ash.

Major negative-dominant planes are even more severe. Each round, those within must make a saving throw or lose one level to energy drain. A creature whose level is reduced to zero is slain, becoming a wraith. *Death ward* protects a traveler from the damage and energy drain of a negative-dominant plane.

Alignment Traits

Some planes have a predisposition to a certain alignment. Most of the inhabitants of these planes also have the plane's particular alignment, even powerful creatures such as deities. In addition, creatures of

alignments contrary to the plane have a tougher time dealing with its natives and situations.

On planes that are strongly aligned, those of an opposing alignment suffer a -2 penalty to all saving throws and divine spellcasters suffer a 10% chance of spell failure.

Magic Traits

Magic can work differently on different planes. Some are magical dead zones on which no magic ever works, others make spellcasting difficult and have a percentage chance of spell failure set by the TK.

Some planes do not permit specific spells or schools of magic to work. A planet of vampires, for example, might not permit any light spells to work, or enchantment spells might not work on a planet of pure logic.

Other planes increase the power of magic on the plane, doubling or tripling the variables of spells, or maybe just one variable. Perhaps there is a plane on which all spells have a duration of "permanent".

There can also be planes of wild magic, where all spells are subject to being warped. Any spell used on a wild magic plane has a chance to go awry. The caster must make a saving throw with a penalty equal to the level of the spell or effect for the magic to function normally. Failure on this check means that something strange happens; roll d% and consult the table to the right.



Wild Magic Table

d%	Effect
01-19	Spell rebounds on caster. If the spell cannot affect the caster, it fails.
20-23	A circular pit 15 feet wide opens under the caster's feet; it is 10 feet deep per level of the spell.
24-27	The spell fails, but the target or targets of the spell are pelted with a rain of small objects (anything from flowers to rotten fruit), which disappear upon striking. The barrage continues for 1 round. During this time the targets are blinded and must make saves to cast spells.
28-31	The spell affects a random target or area. To generate a random direction, roll 1d8 and count clockwise around the compass. To generate random range, roll 3d6. Multiply the result by 5 feet for close range spells, 20 feet for medium spells, or 80 feet for long range spells.
32-35	The spell functions normally, but is not expended from the caster's mind (a sorcerer's spell slot can be used again). An item does not lose charges, and the effect does not count against an item's use limit.
36-39	The spell does not function. Instead, everyone within 30 feet of the caster receives the effect of a <i>heal</i> spell.
40-43	The spell does not function. Instead, a <i>darkness II</i> and <i>silence</i> effect cover a 30-foot radius around the caster for 2d4 rounds.
44-47	The spell does not function. Instead, a <i>reverse gravity</i> effect covers a 30' radius around the caster for 1 round.
48-51	The spell functions, but shimmering colors swirl around the caster for 1d4 rounds. Treat this as a <i>glitterdust</i> effect.
52-59	The spell does not function. Any material components are used up. The spell or spell slot is used up, and charges or uses from an item are used up.
60-71	Nothing happens. The spell does not function. Any material components are not consumed. The spell is not expended from the caster's mind (a spell slot or prepared spell can be used again). An item does not lose charges, and the effect does not count against an item's or spell-like ability's use limit.
72-98	The spell functions normally.
99-00	The spell functions strongly. Saving throws against the spell incur a -2 penalty. The spell has the maximum possible effect.

How Planes Interact

Planes may interact with each other in a variety of ways. Some planes are completely separate, like two planets in different orbits. Travel between two separate planes must be done through a third plane, usually the Astral. Other planes are connected at various points, called portals, while still others are so close to one another that travel can be accomplished at almost any point. Infinities

may be broken into smaller infinities, and planes into smaller, related planes. These "layers" are effectively separate planes of existence, and each layer can have its own planar traits. Layers are connected to each other through a variety of portals, vortices, paths, and borders.

Access to a layered plane from elsewhere usually happens on a specific layer: The first layer of the plane, which can be either the top layer or the bottom layer, depending on the specific plane. Most fixed access points (such as portals and natural vortices) reach this layer, which makes it the gateway for other layers of the plane. The plane shift spell also deposits the spellcaster on the first layer of the plane.

Planes can also take the form of "strings" that crisscross the Astral Plane. These planar strings may have any shape or size when one is actually on that plane, but on the Astral Plane, they appear to be infinite cords. Where two cords meet, there is a planar nexus that combines the traits of one or more planes. You might have a nexus that combines Elemental Fire and Negative Energy, or one that combines Chaotic Good with Elemental Water.

These nexuses can be reached via the connecting planes, appearing as weird physical geographies.

One Possible Cosmology

This cosmology is inspired by the old Ptolemaic view of the universe, viz. The Earth at the center of the universe surrounded by "crystal spheres" containing the different planets and beyond them the Empyrean Heaven of God and His angels. At the center of Earth lies Hell, which is essentially a plane within a plane.

In this cosmology, the Ethereal Plane extends beyond the Earth to the Moon, but no further. The Astral Plane extends throughout the entire universe, to the borders of the Empyrean Heaven. All of the planes in this cosmology other than the Empyrean Heaven take the form of self-contained spheres (i.e. planets). Heaven is infinite.

Travel through the Astral Plane is possible, but one must enter one plane before they can re-enter the Astral Plane and travel to the next plane.

Earth and the Moon (Material Plane)

Earth and the Moon are the Material Plane, the center of the universe. The Moon differs from Earth only in that it is mildly-chaotic. These planes define what is considered normal. The Material Plane has normal gravity, normal time, no special elemental or energy traits and normal magic.

The Moon's importance is, of course, as a jumping off point to the wider cosmos. It is a wild, rugged place, with grey deserts that sparkle with stardust and shallow seas of grey-green brackish water and "forests" of ambulatory fungus crowding the shores. The seas are home to Lovecraftian crustaceans, fish and giant frogs, while the deserts are patrolled by tribes of berserk nomads swathed in robes and riding giant woolly caterpillars that one day turn into massive moths that flock around the Moon as normal moths flock around lights. There are no settlements on the Moon's surface beyond small trading posts for the miners and planar travelers who visit the planet. These trading posts are thick with cats. Beneath the surface are the fabulous city-states of the dromites.

The Ethereal Plane

The Ethereal Plane overlaps with the Earth and Moon. The Material Plane is visible from the Ethereal Plane, but appears as a pointillist painting. Normally, creatures on the Ethereal Plane cannot attack creatures on the Material Plane, and vice versa. A traveler on the Ethereal Plane is invisible, incorporeal, and silent to someone on the Material Plane.

The Ethereal Plane has no gravity, and people can move here in any direction they wish. It is mostly devoid of structures and impediments. It does, however, have its own inhabitants. Some of these are other mere travelers, but the ghosts found here pose a particular peril to those who enter the plane.

Spells function normally on the Ethereal Plane, though they do not cross into the Material Plane. The only exceptions are spells of force and abjuration spells that affect ethereal beings. Spellcasters on the Material Plane must have some way to detect foes on the Ethereal Plane before targeting them with force spells, of course. While it's possible to hit ethereal enemies with a force spell cast on the Material Plane, the reverse isn't possible. No magical attacks cross from the Ethereal Plane to the Material Plane, including force attacks.

Shadow Plane

The Shadow Plane is a dimly lit dimension that overlaps with the Material Plane. For this reason, a planar traveler can use the Shadow Plane to cover great distances quickly. The Shadow Plane also connects to other planes, so long as they have shadows on them. With the right spell, characters can use the Shadow Plane as a way to journey to other planes of reality.

The plane is a world of black and grey. Color has been bleached from the environment. It otherwise appears similar to the Material Plane, with twilight forests, placid black oceans and rolling grey hills. Despite the lack of light sources, various plants, animals, and humanoids call the Plane of Shadow home.

Shadow spells have their variables maximized on this the Shadow Plane. For this reason, the more eccentric illusionist lords sometimes settle here, reigning over their courts of shadows.

Spells that use or generate light or fire may fizzle (50% chance) when cast on the Plane of Shadow. Spells that produce light are less effective in general, because all light sources have their ranges halved here.

The Astral Plane

The Astral Plane is the space between the planes, though which all inter-planar travelers pass. The Astral Plane is a great, endless sphere of clear silvery sky, both above and below. Occasional bits of solid matter can be found here, but most of the Astral Plane is an endless emptiness. Both planar travelers and refugees from other planes call the Astral Plane home.

The Astral Plane is plied by merchants and pirates who speed through the silvery void in strange ships propelled by the powerful emotions of their rowers. The kith-yin are the most dangerous of the plane's pirates, but they are not the only ones. The trade lanes are protected by astral paladins mounted on giant butterflies.

The bits of matter form archipelagoes in the astral sea. Some are used as bases by the astral pirates, others hold the meteoric iron monasteries of the kith-zan, temples to the weird xao or the towers of reclusive wizards.

The Astral Plane has subjective directional gravity. It is also timeless. Age, hunger, thirst, poison, and natural healing do not function in the Astral Plane, though they resume when the traveler leaves the Astral Plane.

Mercury (Elemental Plane of Earth)

Mercury is a sphere of rock and metal riddled with a multitude of tunnels and caverns. It is, in effect, a dungeon world. An unwary and unprepared traveler to Mercury may find himself entombed within this vast solidity of material and have his life crushed into nothingness, his powdered remains a warning to any foolish enough to follow. Despite its solid, unyielding nature, Mercury is varied in its consistency, ranging from soft soil to veins of heavier and more valuable metal.

One face of Mercury is ever bathed in the fires of the Sun, and is terribly hot. The other side is always dark and is terribly cold. Between these two extremes there is a temperate zone that runs completely around the planet. Much of this land is wracked by storms as hot and cold air clash overhead, and amber grasses and vines (including assassin vines) grow wild. Most of the animal life lives underground in burrows, including the highly wrinkled and ornery Mercurial gnomes.

Of particular note is the Garde, a pleasant, peaceful land located at the planet's extreme north. Surrounded by mountains which serve as defensive ramparts, it is home to a great savannah of strange animals and their strange, peaceful elan custodians. This paradisiacal garden is defended from the armies of the two shaitan pashas of the blazing east and the frigid west and their demon armies by armies of crystalline angels and aasimars. Those who run afoul of the shaitan find themselves thrown into the endless dungeons beneath Mercury's surface, there to face all manner of elemental horrors.

Mercury is an earth-dominant plane. Spells that use, manipulate, or create earth or stone have double the power, double the range and double the duration on Mercury. Spells that use or create air (including spells that summon air elementals or airy outsiders) have a 50% chance of failure on Mercury. Gravity is variable on Mercury. Each day, there is a 15% chance it is medium, and otherwise is light.

Venus (Positive Energy Plane)

Venus is a lush world of brilliant, almost blinding color and overgrown vegetation and animals. Some areas of the plane are so fertile that entering them can actually cause a person to explode with life. While the whole of Venus is minor positive-dominant, some regions are major positive-dominant trait instead, and those islands may be inhabited by various divinities of fertility and life.

Venus is a green world – green seas that rage and roil, beaches of emerald dust, green hills and woodlands and even deserts blasted with winds and marked by great pillars and crags of solid jade. This wild land is heavily populated. The beastmen are the most common danger here, but there are also hawk-man tribes in the desert lands, locathah slavers lurking along the coasts and ape-man villages fighting with the amazons for control of the hill country. Deep in the woodlands is the land of Fairy, a land of brash sidhe lords and ladies and the ancestral deities of the elves. Besides these “civilized” dangers, Venus is inhabited by prehistoric beasts.



Spells that use positive energy, including *cure wounds* spells, have all their variables maximized on Venus. A cleric's turn undead ability is also maximized. Spells that use negative energy (including *inflict wounds* spells) do not function on Venus.

Mars (Plane of Neutrality)

Mars is an Earth-like plane fought over between the factions of Lawful Neutrality and Chaotic Neutrality. It is a small sphere covered by red sandstone hills, crimson deserts, lowlands covered with of red, tuberous plants watered by vast canals and gleaming, ancient cities slowly falling into ruin. The Martians glory in warfare.

Mars has light gravity. Only mind-affecting spells and divinations work properly on Mars. All other spells fail to operate at all. Time passes more quickly on Mars than the Material Plane. A week spent on Mars corresponds to a day on the Material Plane.

Sun (Elemental Plane of Fire)

Everything is alight on the Sun. The ground is nothing more than great, ever shifting plates of compressed flame. The air ripples with the heat of continual firestorms and the most common liquid is magma. The oceans are made of flaming gasses. Fire survives here without need for fuel or air, but flammables brought onto the plane are consumed readily.

The Sun is an elemental fire plane. Spells of fire have all of their variables maximized on the Sun and their ranges and durations doubled. Spells that use or create water (including spells that summon water elementals or watery outsiders) have a 50% chance of spell failure.

Jupiter (Elemental Plane of Air)

Jupiter is a giant, spherical plane of roiling air. At the heart of Jupiter there is a core of iron and adamantite, and there are other bits of solid ground and water vapor floating amid the endless skies. Jupiter is the home of all manner of airborne creatures. Indeed, flying creatures find themselves at a great advantage on this plane. While travelers without flight can survive easily here, they are at a disadvantage.

Jupiter is an elemental air plane. Spells of air have all of their variables maximized and their ranges and durations doubled. Spells that use or manipulate earth (including spells that summon earth elementals or earthy outsiders) have a 50% chance of spell failure.

Saturn (Plane of Chaotic Neutrality)

Saturn is a plane infused with Chaos, and therefore quite alien to most folk of the Material Plane. It is covered by all manner of fascinating landscapes, including ashen plains cut by streams of mercury, swamps of sentient ooze, thickets of mineral plants like sheaves of swords and towering mountains of vapor, all under a greenish-black sky illuminated by the plane's wondrous rings, from which *ioun stones* are plucked. Saturn is inhabited by *xaoc* and aberrations.

Saturn is strongly aligned with Chaotic Neutrality. All Lawful Neutral creatures suffer a -2 penalty to saving throws on Saturn. In addition, Saturn has the wild magic trait, making the use of spells quite dangerous (though natives enjoy a +5 bonus to their saving throws against wild magic when they cast spells).

Neptune (Elemental Plane of Water)

Neptune is a sea without a floor or a surface; an entirely fluid sphere lit by a diffuse glow. It is one of the more hospitable of the elemental planets once a traveler gets past the problem of breathing.

The eternal oceans of this plane vary between ice cold and boiling hot, between saline and fresh. They are perpetually in motion, wracked by currents and tides. The plane's permanent settlements form around bits of flotsam and jetsam suspended within this endless liquid. These settlements drift on the tides of Neptune. The sea of Neptune bear witness to the great fleet battles of the Neptunian corsairs, who serve Marid rulers.

The gravity on Neptune is similar to that of the Elemental Plane of Air, but sinking or rising on the Elemental Plane of Water is slower and less dangerous than on the Elemental Plane of Air.

Neptune is a water plane. Spells of water and cold have all of their variables maximized and their ranges and durations doubled. Spells that use or create fire (including spells that summon fire elementals or fiery outsiders) have a 50% chance of spell failure.

Uranus (Plane of Lawful Neutrality)

Uranus is the opposite of Saturn, a plane of Law and perfection. Uranus has the same landscapes as the Material Plane, but they are each a perfect geometric shape. The skies and landscapes of Uranus all carry a metallic hue; warm coppers, brilliant silvers and dazzling golds. Uranus is inhabited by the polyhedroids, who maintain the order of the cosmos, and their foot-soldiers, the relentless inevitables.

Uranus is strongly aligned with Lawful Neutrality. All Chaotic Neutral creatures suffer a -2 penalty to saving throws on Uranus. Time does not flow here.

Pluto (Negative Energy Plane)

To an observer, there's little to see on Pluto. It is a dark, empty place, an eternal pit where a traveler can fall until the plane itself steals away all light and life. Pluto is the most hostile of the planets, and the most uncaring and intolerant of life. Only creatures immune to its life-draining energies can survive there.

The grey world is home to tribes and kingdoms of wights, vampires and other undead, as well as numerous terrible lich lords.

Pluto has subjective directional gravity. Some areas within the plane have only the minor negative-dominant trait, and these islands tend to be inhabited. The rest of the plane is major negative-dominant trait.

Spells and special abilities that use negative energy have all their variables maximized on Pluto. Spells that use positive energy, including *cure wounds* spells have a 50% chance of spell failure. Characters on this plane take a -5 penalty on saving throws made to regain lost levels from energy drain.

Hell (Demiplane of Evil)

Hell is a demi-plane located within the Material Plane. One can travel to Hell via the Ethereal Plane or by descending underground, beyond the deepest dungeons. Hell is inhabited by devils and evil souls, both groups being punished here for eternity by the forces of Good.

Hell has normal gravity and time. It is mildly negative-dominant, is strongly aligned with Evil and is mildly aligned with Law. One version of the nine rings of Hell can be found in issues 11 to 15 of *NOD*, my magazine of old school gaming.

The Firmament

The Firmament is the fixed sphere of stars that lies beyond Uranus. Here one finds the myriad demi-planes called "stars", as well as the elusive *ioun stones* sought after by adventurers. Beyond these strange stars lies the energy curtain that separates the cosmos from the Empyrean Heaven, guarded by the archons.

Empyrean Heaven (Plane of Good)

The Empyrean Heaven is an infinite plane that exists beyond all the other planes. It is home to the gods and goddesses of law and goodness and their servants, the Angels and Archons. The Empyrean Heaven is a major positive-dominant plane and is strongly aligned with Good and Law.

Thus ends our little tour of one possible organization of planes. There are many other ways to do this, of course, and when your players get high enough in level you can indulge in building your own little cosmos.



Treasure

11

Nobody is stupid or blood-thirsty enough to sally forth and slay monsters without expecting a reward, not even an adventurer. After all, even psychotics have to fill their bellies, and that peasant will not build your stronghold out of the goodness of his heart. Hence, treasure!

Most sentient monsters (i.e. with an intelligence of low or higher) have some amount of treasure stored away in their lair, and some might carry a small portion with them in their purses. Monsters that do not have a lair can only carry around as much treasure as their strength allows – assume a strength of 3 for tiny monsters, 7 for small monsters, 10 for medium monsters, 15 for large monsters and 20 for huge monsters.

Individual Treasure

Lone humanoids and giants carry individual treasure when they are away from their lairs.

CL	CP	SP	GP	Gems	Magic
0	4d6	-	-	-	-
1-2	-	3d6	-	1*	1*
3-4	-	-	2d6	1**	1**
5+	-	-	3d6	1***	1***

Treasure Hoards

Hoards are found in lairs of large groups of monsters. Coins on this table are given in thousands.

CL	CP	SP	GP	Gems	Art	Magic
0-2	1d4**	1d3*	-	-	-	-
3-5	1d4***	1d4**	1d2*	-	-	-
6-8	1d6***	1d4***	1d3*	1d4*	-	-
9-11	1d8**	1d6***	1d4*	1d4**	-	1*
12-14	1d8**	1d8***	1d8**	1d6**	-	2*
15-17	1d8*	1d10***	2d6**	1d8**	-	3*
18-20	1d8*	2d6***	2d6***	1d8**	-	3**
21+	1d6*	3d6***	4d6***	2d6**	1d6*	4**

* 1 in 6 chance of this being in the treasure hoard

** 2 in 6 chance of this being in the treasure hoard

*** 3 in 6 chance of this being in the treasure hoard



Dragon Hoards

Chromatic and metallic dragons have larger hoards than other monsters. Other dragons, like wyverns, use the normal treasure hoard table. Coins on this table are given in thousands.

Age	CP	SP	GP	Gems	Art	Magic
1-3	1d8*	2d6***	2d6***	1d8**	-	3**
4-5	1d6*	3d6***	4d6***	2d6**	1d6*	4**
6	-	3d6	5d6	2d6***	1d8**	4***

Coins

Coins have already been explained in the Equipment chapter. Assume that 4 coins fit into a cubic inch. A chest 24" x 16" x 20" could hold more than 30,000 coins!

Gems

Gems come in three qualities and three sizes: Small (½" diameter, 15 to the pound), medium (1" diameter, 3 to the pound) and large (3" diameter, 10 lb.). To find the type of gem found, roll 1d20 for the type, and 1d10 for the size.

Roll	Type	1-7	8-9	10
		Small	Medium	Large
1-14	Bauble	1 gp	5 gp	100 gp
15-19	Gem	20 gp	100 gp	2,000 gp
20	Jewel	100 gp	500 gp	10,000 gp

Baibles: Agate, amber, aventurine, bloodstone, carnelian, chalcedony, chrysoprase, citrine, coral, cymophane, fire opal, garnet, hawk’s eye, hematite, hyacinth, jacinth, jade, jargoon, jasper, jet, lapis lazuli, malachite, moonstone, obsidian, olivine, pearl, peridot, quartz, rock crystal, sardonyx, serpentine, star sapphire, tiger’s eye, turquoise, zircon.

Gems: Aquamarine, beryl, chrysoberyl, onyx, opal, rhodochrosite, spinel, sunstone, topaz, tourmaline.

Jewel: Amethyst, diamond, emerald, ruby, sapphire.

Art Objects

Art objects include tapestries, jewelry, paintings and other fine artwork. To keep things simple, make a D% roll to determine what the item is made of, and thus how much it is worth. Items have a 5% chance of being jeweled and worth an additional 500 gp.

d%	Material	Examples	Value
01-30	Copper*	Vessel, jewelry, sculpture	10 gp
31-35	Exotic Wood**	Vessel, sculpture	10 gp
36-45	Silk***	Clothing	50 gp
46-50	Rare Stone****	Vessel, sculpture	100 gp
51-75	Silver	Vessel, jewelry, sculpture, crown	100 gp
76-80	Cloth-of-gold	Clothing	250 gp
81-85	Electrum	Vessel, jewelry, sculpture	250 gp
86-95	Gold	Vessel, jewelry, sculpture, crown	500 gp
96-98	Ivory	Vessel, jewelry, sculpture	500 gp
99	Platinum	Jewelry, crown	1,000 gp
00	Mithral	Jewelry, crown	1,000 gp

*Also billon, bronze, brass, hepatizon (black bronze), orichalcum, potin or speculum

**Includes mahogany, ebony, cherry

***Includes velvet, damask, satin, or tapestries or paintings

****Includes alabaster, malachite, marble, porphyry, quartz

Clothing: Bodice, cap, cape, cloak, chemise, doublet, gown, hat, hose, kilt, robe, shirt, skirt, tabard, trousers, tunic, turban. Clothing has a 5% chance of being trimmed with fur and worth twice as much as normal.

Crowns: Anadems, Coronets, Circlets, Diadems, Faislum, Tiara, Wreath.

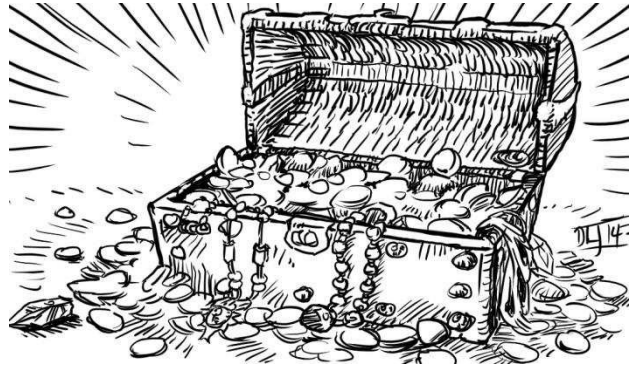

Jewelry: Anklet, band, bangle, bauble, bracelet, brooch, cameo, chain, earrings, lavalier, locket, necklace, pendant, pin, ring, torque.

Sculpture: Bas-relief, figurine, icon, idol, mask, statue, statuette. Assume that statues are 1d12 feet in height and weigh about 20 lb. per foot of height for metal, ivory and wood and 50 lb per foot for stone.

Vessels: Candelabra, candlestick, chalice, ewer, flacon, flagon, flask, flasket, goblet, phial, pricket, sconce, stein, trencher, tourine, urn, vase.

Magic Items

Magic items are divided into the following categories: Armor, weapons, potions, rings, rods, scrolls, staves, wands and wondrous items. In addition, some magic items are cursed or intelligent. A few magic items are of such rarity and power that they belong to a category called artifacts. Artifacts are classified in turn as minor (extremely rare but not one-of-a-kind items) or major (each one unique and potent).

Using Magic Items

To use a magic item, a person must activate it. Sometimes this is as easy as putting the item on. Scrolls must be read, potions drunk, and some items are activated by speaking a “command word”. If no activation method is suggested either in the magic item description or by the nature of the item, assume that a command word is needed to activate it. The spells *identify* and *analyze dweomer* both reveal command words, as can consulting a sage.

Size and Magic Items

When an article of magic clothing or jewelry is discovered, the size of that object should not be an issue.

Magic garments and magic armor adjust themselves magically to the wearer's size.

Intelligent Items

Some magic items, particularly weapons, have an intelligence all their own. Only permanent magic items (as opposed to those with a single use or those with charges) can be intelligent. This means that potions, scrolls, and wands, among other items, are never intelligent. In general, less than 1% of magic items have intelligence.

Cursed Items

Some items are cursed. Cursed items might be particularly dangerous to the user, or they might be normal items with a minor flaw, an inconvenient requirement, or an unpredictable nature. Randomly generated items are cursed 5% of the time.

Charges, Doses and Multiple Uses

Many items, such as wands and staves, are limited by the number of charges they hold. Normally, charged items have 10 charges at most. If such an item is found as a random part of a treasure, roll 1d10 to determine the number of charges left. Potions have one dose.

d20	Item Table
1	Armor and shields
2	Weapons
3-8	Potions
9	Rings
10	Rods
11-13	Scrolls
14	Staffs
15	Wands
16	Wondrous item, table 1
17	Wondrous item, table 2
18	Wondrous item, table 3
19	Treasure map
20	Scientific items (optional, see Appendix A)

Creating Magic Items

Many spell casters believe that the creation of a magic item is the height of their art. For most players, creating magic items is a heck of a lot easier than waiting for the TK to include the item they want for their character in a stupid dungeon. Because magic items are so prized (and so useful), creating them must be difficult.



Magic-users and sorcerers of 11th level or higher can create virtually any magic item. They cannot create an item that relies on a spell possessed only by clerics or druids. They cannot create magical books (not including spellbooks), manuals or librams. These items represent ancient knowledge that must be discovered, not manufactured. They also cannot create *ioun stones*, which are naturally occurring objects plucked from strange dimensions. Finally, they cannot create artifacts, as these items can only be created by deities.

Clerics and druids of 11th level or higher can create potions, scrolls, wands and staves usable by their class.

There are two steps to creating a magic item:

First, the required materials and helpers must be gathered. This can take a great deal of time, as the needed ingredients are rare.

Second, the spell caster must spend time and money creating the magic item and then roll to see if his or her efforts were successful.

Time

The time required to make a magic item is 1 day per 100 gp of the item's value. The chance of success is equal to 80% plus the level of the spell caster, with a maximum chance of success equal to 99%. A failed roll still produces a magic item, but the item is a cursed version of the intended item. This roll is made at the end of the process, and is made without the spell caster's knowledge; the spell caster should always think their work has been successful.

A day of labor on a magic item is 12 hours. The spell caster cannot rush the process by working longer each day. The days need not be consecutive, and the caster can use the rest of his time as he sees fit. A character can work on only one item at a time.

Materials

The cost to make an item is equal to half the gold piece value of the item, which can be divided up by the creator between hiring a master craftsman and alchemist to help, and the tools and props needed to enchant the item.

The item to be enchanted must be made by a master craftsman under the watchful eye of the magic item's creator using the best possible materials.

Magic weapons, armor, rings and rods must be forged from meteoric iron, mithral or adamantite or, for rings and rods, silver, gold or platinum.

Leather goods must be made from rare and expensive monster hides.

Cloth goods must be made from expensive fabrics (silk, velvet, cloth-of-gold, wool from the exceptionally fine sheep, the hair of virgins, etc.).

Wooden items like staves and wands must be carved from rare and expensive woods or from plant creatures.

Scrolls must be scribed on vellum prepared by a master parchmentier or chiseled in an expensive variety of stone (malachite, porphyry). The ink must be prepared with a base of giant octopus ink.

Potions must be brewed in vats made of precious metal (copper or better) with the assistance of an alchemist.

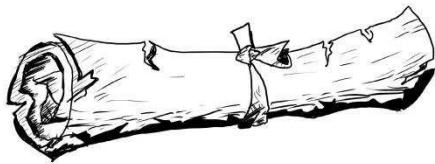

Magical Materials

All magic items are tied to an equivalent spell or spells as determined by the Treasure Keeper. The "equivalent spell" is a spell that matches, more or less, the abilities of the magic item to be created. A *flaming sword*, for example, might be tied to *fireball*. The spell caster must be able to cast this spell to create the magic item. In essence, they are binding the spell into the object.

For each level of the equivalent spell (or combined levels of the equivalent spells), the magic item requires a "magical element". The type of each magical element can be rolled randomly or chosen by the TK. If you do roll the magical element randomly, roll a d10 if creating a potion or scroll, or d12 for all other sorts of magic items.

d12	Magic Element
1-2	Herb (harvested with a silver sickle by the spell caster)
3-6	Mineral (discovered in a dungeon by the spell caster)
7-10	Monster Part (slain by the spell caster and his comrades)
11	Place
12	Time

The magical element should be tied to the overall theme of the magic item that is being created. The necessary magic elements, as determined by the Treasure Keeper, are the magic item's formula. Each magic item is tied to its creator or the person who possesses or uses it, and the magical elements usable in one creation may not be usable in the creation of a second item of the same kind. This rule is intended to keep magic item creation from becoming a simple process of mass production for high level characters.

Herbs

Herbs may be ground, steeped in essential oils, burned on a brazier during the magic item creation process, or ingested as a tea by those involved in creating the item.

Herb	Magical Correspondences
Angelica	Good and lawful spells, abjurations, summoning
Anise	Abjurations and divinations (esp. clairvoyance)
Basil	Strength, fire, evocations, necromancy, command, domination
Bamboo	Dispel magic
Caraway	Air spells, charm spells, movement
Cinnamon	Holy spells, mind-effects, communication spells, healing spells
Cloves	Negative energy protection, silence, dispel magic, charm person, astral projection, ethereal jaunt and other travel spells
Coriander	Abjurations
Foxglove	Poison, inflict wound spells
Frankincense	Exorcism, purification, protection, light
Galangal	Luck spells, blessings, remove curse
Garlic	Exorcism, protection from undead, healing, weather spells
Ginger	Fire spells, curses, evocations, spells of travel or movement
Ginseng	Restoration
Hellebore	Exorcism
Henbane	Poison, death spells
Holly	Resist electricity, protection from evil
Horehound	Plant spells, tree spells, hallow
Lavender	Bless, healing, memory spells, sleep, strength, constitution, illusions
Lovage	Charisma, enchantments
Mace	Transmutations
Mandrake	Evocations, summoning, visions

Marigold	Illusions	Emerald	Charms, enchantments, exorcism, mental abilities and vision
Marjoram	Animal spells, necromancy	Fluorite	Chaos spells, <i>cure disease</i>
Mistletoe	Love, druidic spells	Garnet	Abjurations, <i>heal</i>
Mugwort	Astral and ethereal travel	Gold	Spells of purification, positive energy spells
Mustard	Enchantments, dispel magic	Hematite	Mental and psychic spells, time spells
Myrrh	Knowledge, divination, enchantments, healing	Jade	Water spells, wisdom, healing
Myrtle	Creation, enchantments	Jasper	Abjurations, <i>cure disease</i>
Nutmeg	Dream, nightmare, divination	Lapis Lazuli	Psychic spells, <i>remove fear</i> , divinations
Onion	Contact other plane, commune	Malachite	Plant spells, <i>constitution</i> , transmutations
Oregano	Calm emotions, abjurations	Moonstone	<i>Confusion, insanity, wish, neutralize poison, sleep, illusions</i>
Parsley	Haste	Obsidian	<i>Protection from energy, detect evil, true seeing</i>
Peppermint	Animals, energy, protection, resistance, healing, necromancy	Onyx	Lawful spells, command and control, abjurations, <i>wall</i> spells
Pomegranate	Communication with the dead, necromancy	Opal	Emotion spells, memory spells, <i>astral projection, ethereal jaunt, dream, nightmare</i>
Poppy seed	Sleep, dream, nightmare, confusion, insanity, binding, curses	Platinum	Anti-transmutation effects, protection spells
Rosemary	Fear (and remove fear), exorcism, legend lore, alarm, glyphs and other spells that protect items, intelligence, wisdom, water spells	Quartz	<i>Aid, bless, prayer</i> , evocations, cold spells
Saffron	Sun and light spells, divinations, true seeing, detect invisibility, wind spells	Rhodochrosite	Fire spells, <i>legend lore, calm emotions</i>
Sage	Healing, longevity, protection from scrying	Rose Quartz	<i>Atonement, heal, cure disease, resistance</i>
Savory	Animal spells, fey spells	Ruby	Command, growth spells, <i>haste, resistance</i>
Star Anise	Lawful spells, mark of justice, detect lie, hallow, aid, bless, prayer	Sapphire	Wind and water spells, planar travel, abjurations, creation spells
Tarragon	Dragon spells, rage, remove fear	Silver	Energy spells, <i>sleep, insanity, protection spells</i>
Thyme	Fey spells, divinations, necromancy	Sunstone	Sun, light and fire spells, <i>bless, strength</i>
Turmeric	War, weapons, exorcisms, hold spells, mage armor, shield	Tiger Eye	Animal spells, <i>true seeing, divinations</i> , travel spells
Wormwood	Illusions, insanity, confusion	Topaz	Blessings, evocations, mineral detection
		Tourmaline	Heal spells, mental spells, plant spells
		Turquoise	Earth spells

Minerals

Minerals might be powdered and added to other elements of the magic item, or used in the construction of the magic item. For example, a ruby might be ground down and added to the meteoric iron used to forge a *flaming sword*, or it could be set in the pommel of that sword. The value of the mineral used goes toward the total cost of creating the item.

Mineral	Magical Correspondences
Agate	Plant spells, physical ability boosts, <i>cure</i> spells, abjurations
Amber	Sun and light spells, detect spells
Amethyst	Mind affecting, hearing and armor-enhancing spells, <i>remove curse, break enchantment</i>
Aventurine	Earth spells, <i>knock, passwall, remove curse</i>
Bloodstone	<i>Remove fear</i> , enhance physical abilities, <i>heroism, mage's transformation</i>
Carnelian	Abjurations, fire spells, spells of movement (<i>fly, jump, haste</i>)
Chrysoberyl	<i>Spell turning, locate object, awareness, mirror image</i>
Copper	<i>Remove fear, neutralize or delay poisons, communication</i>

Monster Parts

This element requires the eye, hair, feather, skin, gland, organ, claw, tooth, etc. of a magical monster. "Magic monsters" includes aberrations, dragons, fey, giants, monsters, outsiders and undead. One might substitute a legendary personage (at least 12th level) associated with the power being woven into the item, for example the hair from an archmage's beard or the finger bone of a saint. The source of the element must have twice the Hit Dice of the level of the equivalent spell to be used, and the object has a value of 100 gp per Hit Dice that is applied towards the total cost of the spell.

Place

A required place usually must be where the item is created and enchanted. Suitable locales include ruined temples, ancient palaces, places associated with the life (or death) of a god, demigod or legendary hero, places associated with magical or historic events, stone circles created by very high level druids, temples established by very high level clerics, an elemental plane or demi-plane,

atop a high mountain, on a fabled or mythic island, on the rim of an active volcano, in a cloud giant's castle or a storm giant's undersea palace or a titan's fortress, in or near the waters of a magic pool or fountain, at the bottom of a deep chasm, near the pounding surf or a rushing river or in the waters of a holy river.

Time

A special time usually represents the final moment of creation. It might be a specific phase of the Moon, a solstice or equinox, specific position of stars, anniversary of magical or historic event, during a storm, earthquake or other natural cataclysm or during a meteor shower.

Example: *Flaming Longsword*

The Treasure Keeper rules that *fireball* is the equivalent spell for a flaming longsword. *Fireball* is a 3rd level spell, so there must be three rolls on the magical elements table. The TK rolls and gets mineral, monster and time. He decides the required mineral is a carnelian worth 3,000 gp, the monster a salamander's blood and the time of the final enchantment is during a meteor shower. The magic user must also provide a sword made of meteoric iron. The magic-user must use divinations to discover when and where a meteor shower is to occur, and of course he'll have to liberate a carnelian from a dungeon and slay a salamander. The services of an alchemist are needed to prepare the carnelian powder. While the sword is finished by a master smith during a meteor shower, the magic-user mingles in the carnelian powder and salamander blood and casts *fireball*.

Example: *Cape of the Mountebank*

The sorcerer must provide 5,000 gp worth of materials for this cape, which must be woven of silk or another expensive material, probably with gold or silver thread embroidered in it. It is associated with the *dimension door* spell, a 4th level spell of movement and travel. Rolling the dice, the Treasure Keeper decides that the sorcerer needs an herb, two minerals and a place. He decides the place is the tomb of an infamous wizard. The enchantment, though not the manufacture of the cloak, must occur there. The herb is ginger, which must be brewed into ale and consumed by the magic-user while creating the item. The "minerals" are sapphire and tiger's eye, which must be powdered and mixed into a dye for the cloak. The cloak will have silver threads embroidered into it to form symbols of power.

Magic Armor

Magic armor offers better protection to the wearer than non-magical armor. Each piece of magic armor has a "bonus" that is added to the player's Armor Class in addition to the normal Armor Class bonus provided by the armor. Some armor has an additional special ability.

Magic Armor

d20	Armor Type
1	Padded
2-4	Leather
5	Ring mail
6	Studded leather
7	Scale mail
8-10	Chainmail
11	Banded mail
12	Splint mail
13-14	Platemail
15	Plate Armor
16-17	Buckler
18-19	Shield
20	Special armor or shield

d20	Armor Bonus	Shield Bonus	Value
1-9	+1	+1	1,000 gp
10-14	+2	+1	4,000 gp
15-17	+3	+2	9,000 gp
18-19	+4	+2	16,000 gp
20	+5	+3	25,000 gp

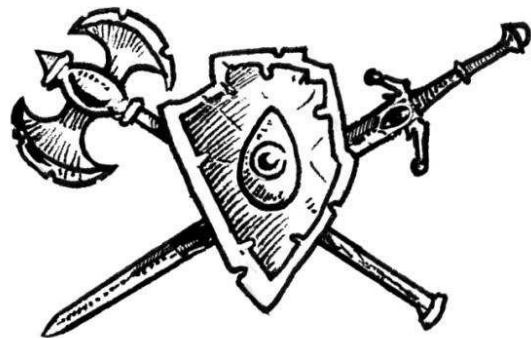

Special Magic Armor

d20	Armor	Value
1	Mithral shirt	1,000 gp
2	Elven chain	4,000 gp
3	+1 animated shield	5,000 gp
4	+1 leather armor of shadows	5,000 gp
5	+2 shield of blinding	5,000 gp
6	+1 shield, +4 vs. missiles	9,000 gp
7	+2 lion's shield	9,000 gp
8	+2 ghostly chainmail	14,000 gp
9	+3 winged shield	17,000 gp
10	+1 chainmail of cold resistance	19,000 gp
11	+1 chainmail of electricity resistance	19,000 gp
12	+1 chainmail of fire resistance	19,000 gp
13	+3 banded mail of luck	19,000 gp
14	+3 celestial chainmail	22,000 gp
15	+1 plate armor of the deep	24,000 gp
16	+2 platemail of command	25,000 gp
17	+1 platemail of speed	27,000 gp
18	+2 buckler of spell turning	29,000 gp
19	+1 platemail of etherealness	50,000 gp
20	+4 demonic plate armor	52,000 gp

+1 Animated Shield: Upon command, this shield floats within 2' of the wielder, protecting her as if she were using it herself. Only one can be used at a time.

+1 Leather Armor of Shadows: This armor grants a +3 bonus on hide in shadows task checks.

+1 Plate Armor of the Deep: This +1 *platemail* is decorated with a wave and fish motif. The wearer can breathe underwater and can converse with any creature with a language that breathes water. The armor gives the wearer a swim rate of 20' per round.

+1 Platemail of Etherealness: On command, this platemail allows the wearer to become ethereal once per day. The character can remain ethereal for as long as desired, but once he returns to normal, he cannot become ethereal again that day.

+1 Platemail of Speed: The wearer of this fine set of platemail can activate it, enabling her to act as though affected by a *haste* spell for up to 10 rounds each day. The duration of the *haste* effect need not be used in consecutive rounds. The armor only weighs 25 pounds.

+1 Shield, +4 vs. Missiles: This shield grants a +1 bonus to AC against melee weapons, and a +4 bonus to AC vs. ranged and thrown weapons, including boulders.

+2 Buckler of Spell Turning: This buckler has a mirror finish. Once per day, it can be called on to reflect a spell back at its caster exactly like the *spell turning* spell.

+2 Chainmail of Cold Resistance: This chainmail grants resistance to cold damage.

+2 Chainmail of Electricity Resistance: This chainmail grants resistance to electricity damage.

+2 Chainmail of Fire Resistance: This chainmail grants resistance to fire damage.

+2 Ghostly Chainmail: This silver chainmail provides protection against the attacks of incorporeal creatures.

+2 Lion's Shield: This +2 *shield* is fashioned to appear as a roaring lion's head. Three times per day, the lion's head can be commanded to attack, biting with the wielder's attack bonus and dealing 2d6 points of damage. This attack is in addition to the wielder's attacks.

+2 Platemail of Command: This finely crafted +2 *platemail* bestows a commanding aura upon its owner. The wearer gains a +2 bonus on reaction checks and turn undead checks. Friendly troops within 360' of the user become braver than normal. Since the effect arises in great part from the distinctiveness of the armor, the wearer cannot hide or conceal herself in any way and still have the effect function.

+2 Shield of Blinding: Once per day, this shield can flash with a brilliant light upon command of the wielder. Anyone within 20' except the wielder must make a saving throw or be blinded for 1d4 rounds.

+3 Banded Mail of Luck: Ten gems worth 100 gp each adorn this suit of +3 *banded mail*. Once per week, the armor allows its wearer to require that an attack roll made against him be rerolled. He must take whatever consequences come from the second roll.

+3 Celestial Chainmail: This bright gold +3 *chainmail* is so fine and light that it can be worn under normal clothing without betraying its presence. It weighs 20 pounds and it allows the wearer to use *fly* once per day.

+3 Winged Shield: This round +3 *shield* has small, feathered wings encircling it. Once per day it can be commanded to *fly*, carrying the wielder. The shield can carry up to 133 pounds and move at 60' per round, or up to 266 pounds and move at 40' per round.

+4 Demonic Plate Armor: This plate armor is fashioned to make the wearer appear to be a demon. The helmet is

shaped to look like a horned demon head, and its wearer looks out of the open, tooth-filled mouth. It allows the wearer to make claw attacks that deal 1d6 points of damage, strike as *+1 weapons* and afflict the target as if she had been struck by a *cause disease* spell. Any non-Chaotic creature wearing this armor loses one level (no save allowed). This level cannot be restored by any means while the armor is worn.

Elven Mail: This extremely light chainmail is fashioned by the elves and only weighs 20 lb. Elven fighter/magic-users may wear this armor and still cast spells.

Mithral Shirt: This extremely light chainmail shirt is made of very fine mithral links. It weighs only 10 pounds.

Magic Weapons

Magic weapons have enhancement bonuses ranging from +1 to +5. They apply these bonuses to both attack and damage rolls. Some magic weapons have an additional special ability, and there are also specific magic weapons that might be discovered.

Magic Weapon

d%	Weapon
01-02	Arrows (3d6)
03-07	Axe, hand
08-10	Battleaxe
11-12	Bolts (2d6)
13-15	Bow
16-18	Bullet (3d6)
19-21	Crossbow
22-31	Dagger
32-33	Darts (1d6)
34-36	Flail
37-38	Javelin
39-41	Lance
42-46	Mace
47-48	Military pick
49-50	Morningstar
51	Musket
52-54	Polearm
55-59	Scimitar
60-69	Spear
70-74	Sword, great
75-86	Sword, long
87-94	Sword, short
95-96	Trident
97-99	Warhammer
00	Special Weapon

d20	Melee Bonus	Missile Bonus	Value
1-9	+1	+1	2,000 gp
10-14	+2	+1	8,000 gp
15-17	+3	+2	18,000 gp
18-19	+4	+2	32,000 gp
20	+5	+3	50,000 gp

Special Magic Weapon

d%	Weapon	Value
01-02	<i>Arrow of sleep</i>	150 gp
03-04	<i>Bolt of screaming</i>	250 gp
05-06	<i>Silver dagger</i>	350 gp
07-08	<i>Javelin of lightning</i>	1,500 gp
09-10	<i>Arrow of slaying</i>	2,000 gp
	<i>+1 sword, triple sword</i>	4,500 gp
11-12	<i>+1 sword, shatterer</i>	5,000 gp
13-14	<i>+1 staff, growing</i>	5,000 gp
15-16	<i>+1 crossbow of distance</i>	8,000 gp
17-18	<i>Arrow of seeking</i>	8,000 gp
19-20	<i>+1 cudgel of mercy</i>	8,000 gp
21-22	<i>Club of smashing</i>	8,500 gp
23-24	<i>Dagger of venom</i>	9,000 gp
25-26	<i>Trident of warning</i>	10,000 gp
27-28	<i>+2 dagger, assassin's</i>	10,000 gp
29-30	<i>Bow of magic missiles</i>	13,000 gp
31-32	<i>Crystal sword</i>	13,000 gp
33-34	<i>Gladius</i>	16,000 gp
35-36	<i>+1 sword, +2 vs. magic-using creatures</i>	18,000 gp
37-38	<i>+2 quarterstaff, monk's</i>	18,000 gp
39-40	<i>Axe of throwing</i>	18,000 gp
41-42	<i>Hammer of thunderbolts</i>	18,000 gp
43-44	<i>Mace of disruption</i>	18,000 gp
45-46	<i>Net of entangling</i>	18,000 gp
47-48	<i>Trident of fish command</i>	19,000 gp
49-50	<i>+1 sword, +3 vs. shape changers</i>	21,000 gp
51-52	<i>Flame tongue</i>	21,000 gp
53-54	<i>+2 sword, dancing</i>	22,000 gp
55-56	<i>Dastard's dagger</i>	22,000 gp
57-58	<i>Sword of wounding</i>	22,000 gp
59-60	<i>+2 sword, nine lives stealer</i>	23,000 gp
61-62	<i>+1 sword, +2 vs. insects</i>	24,000 gp
63-64	<i>+1 sword, +3 vs. lycanthropes</i>	24,000 gp
65-66	<i>+1 sword, +4 vs. reptiles</i>	24,000 gp
67-68	<i>+2 sword, dragon slayer</i>	25,000 gp
69-70	<i>+2 sword, giant-slayer</i>	25,000 gp
71-72	<i>Sword of life stealing</i>	26,000 gp
73-74	<i>+2 longbow, oathbow</i>	26,000 gp
75-76	<i>+1 sword, luck blade</i>	30,000 gp
77-78	<i>Sword of wounding</i>	32,000 gp
79-80	<i>+2 sling of seeking</i>	39,000 gp
81-82	<i>Sword of the planes</i>	30,000 gp
83-84	<i>Sword of sharpness</i>	35,000 gp
85-86	<i>Mace of terror</i>	39,000 gp

87	+1 poleaxe, life-drinker	40,000 gp
88	Crossbow of speed	42,000 gp
89	Sylvan scimitar	45,000 gp
90	+4 sword, defending	50,000 gp
91	Crossbow of speed	50,000 gp
92	Sun blade	50,000 gp
93	+3 sword, frost brand	55,000 gp
94	+3 warhammer, dwarven thrower	60,000 gp
95	Hammer of thunderbolts	75,000 gp
96	Mace of smiting	75,000 gp
97	+4 sword, unholy avenger	100,000 gp
98	Power sword	120,000 gp
99	+5 sword, holy avenger	120,000 gp
00	Vorpal sword	300,000 gp

Special Qualities: Roll d%. If the item is a melee weapon, a 01–30 result indicates that the weapon sheds light as a torch, 31–45 indicates that something (a design, inscription, or the like) provides a clue to the weapon’s function and 46–100 indicates no special qualities.

If the item is a ranged weapon, a 01–15 result indicates that something (a design, inscription, or the like) provides a clue to the weapon’s function, and 16–100 indicates no special qualities.

+1 Crossbow of Distance: This property can only be placed on a ranged weapon. A weapon of distance has double the normal range.

+1 Cudgel of Mercy: Creatures reduced to 0 hp by this club are knocked unconscious for 1d4 hours, but never killed.

+1 Dagger of Venom: This black +1 dagger has a serrated edge. It allows the wielder to use *poison* (as the spell) upon a creature struck by the blade once per day.

+1 Poleaxe, Life-Drinker: This +1 poleaxe steals two levels from its target whenever it deals damage, just as if its target had been struck by a wight. One day after being struck, subjects must make a save for each lost level or lose it permanently. Each time a life-drinker deals damage to a foe, it also steals one level from the wielder. Any level lost by the wielder in this fashion is regained one hour later.

+1 Staff, Growing: This staff can be from 1’ to 10’ long, at the wielder’s command. Depending on the staff’s size, it strikes either as a +1 club or a +1 quarterstaff. The staff gives one a +2 bonus on task checks involving acrobatics.

+1 Sword, Triple Sword: This +1 longsword can, two times per day, launch its blade up to 30’ away as a ranged attack. The blade instantly reappears on the pommel the next round.

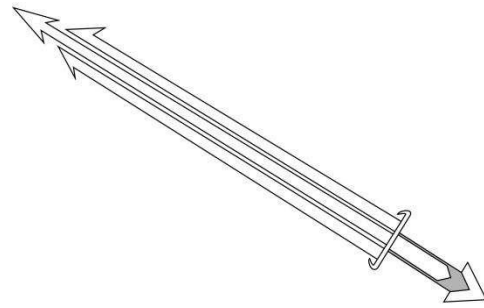

+1 Sword, Flame Tongue: This is a +1 flaming longsword. Once per day, the sword can blast forth a fiery ray at any target within 30’. The ray deals 4d6 points of fire damage on a successful hit.

+1 Sword, Shatterer: This +1 longsword acts as a +4 longsword when used to make sunder attacks. *Shatterer* can damage weapons with a magic bonus of +4 or lower.

+2 Bolt, Screaming: One of these +2 crossbow bolts screams when shot, forcing all enemies of the wielder within 20’ of the path of the bolt to succeed on a saving throw or flee for 1d4 rounds.

+2 Dancing Sword: A dancing weapon can be loosed to attack on its own. It fights for 4 rounds using the attack bonus of the one who loosed it and then drops. In all other respects, it is considered wielded or attended by the creature for all maneuvers and effects that target items. While dancing, it can attack foes adjacent to its owner. The dancing weapon accompanies the person who activated it everywhere, whether she moves by physical or magical means. If the wielder who loosed it has an unoccupied hand, she can grasp it while it is attacking on its own; when so retrieved the weapon cannot dance (don’t ask it) again for 4 rounds.

+2 Longbow, Oathbow: Of elven make, this white +2 longbow whispers “Swift defeat to my enemies” in elven when knocked and pulled. Once per day, if the firer swears aloud to slay her target, the bow’s whisper becomes the low shout “Swift death to those who have wronged me.”

Against such a sworn enemy, the bow has a +5 bonus and arrows launched from it deal an additional 2d6 points of damage. However, the bow is treated as a normal weapon against all foes other than the sworn enemy and the wielder takes a –1 penalty on attack rolls with any weapon other than the *oathbow*. These bonuses and penalties last for seven days or until the sworn enemy is

slain or destroyed by the wielder of the *oathbow*, whichever comes first.

The *oathbow* may only have one sworn enemy at a time. Once the wielder swears to slay a target, he cannot make a new oath until he has slain that target or seven days have passed. Even if the wielder slays the sworn enemy on the same day that he makes the oath, he cannot activate the *oathbow's* special power again until 24 hours have passed from the time he made the oath.

+2 Mace of Terror: On command, this *+2 footman's mace* causes the wielder to transform into an illusion of darkest horror such that living creatures facing her must pass a saving throw or flee the area. The wielder may use this ability up to three times per day.

+2 Monk's Quarterstaff: The magic weapon serves as a channel for the wielder's *ki*, allowing a monk to use her stunning attack, *ki* strike, and quivering palm abilities through the weapon.

+2 Sword, Life Stealing: This black iron *+2 longsword* steals a level when a natural '20' is rolled on an attack. The sword wielder gains 1d6 temporary hit points each time a level is stolen from another. These temporary hit points last for 24 hours. One day after being struck, subjects must make a save for each level lost or the loss is permanent.

+2 Sword, Luck Blade: This *+2 short sword* gives its possessor a +1 bonus on all saving throws. Its possessor also gains the power of good fortune, usable once per day. This allows the weapon's wielder to reroll one roll that she just made. She must take the result of the reroll, even if it's worse than the original roll.

+2 Sword, Nine Lives Stealer: This longsword always performs as a *+2 longsword*, but it also has the power to draw the life force from an opponent. It can do this nine times before the ability is lost. At that point, the sword becomes a simple *+2 longsword* (with a hint of evil about it). A natural '20' must be rolled on an attack for the sword's death-dealing ability to function. The victim is entitled to a save to avoid death. If the save is successful, the sword's death-dealing ability does not function and no use of the ability is expended. This sword is Chaotic Evil, and any Lawful character attempting to wield it loses two levels.

+2 Warhammer, Dwarven Thrower: This weapon functions as a *+2 warhammer*. In the hands of a dwarf, the warhammer gains an additional +1 bonus. It can be hurled with a 30-foot range increment. When hurled, it

deals an extra 2d8 points of damage against giants or an extra 1d8 points of damage against any other target. The warhammer returns to the thrower's hand one round later unless it is somehow barred from moving.

+3 Sword, Frost Brand: This *+3 frost greatsword* sheds light as a torch when the temperature drops below 0°F. At such times it cannot be concealed when drawn, nor can its light be shut off. Its wielder is protected from fire; the sword absorbs half of the fire damage each round that the wielder would otherwise take. A frost brand extinguishes all non-magical fires in its area. It can also dispel lasting fire spells, but not instantaneous effects.

+4 Sword, Defending: This weapon allows the wielder to transfer some or all of the sword's magical attack bonus to his Armor Class.

+4 Sword, Unholy Avenger: This *+1 bastard sword* becomes a *+4 unholy bastard sword* in the hands of an anti-paladin. It provides magic resistance 35% to the wielder. It also enables the wielder to use *dispel magic* (once per round) at the class level of the anti-paladin. It deals double damage against Lawful creatures.

+5 Sword, Holy Avenger: This *+2 longsword* becomes a *+5 holy longsword* in the hands of a paladin. It provides magic resistance 35% to the wielder and anyone within 5' of her. It also enables the wielder to use *dispel magic* (once per round) at the class level of the paladin. It deals double damage against Chaotic creatures.

Arrow of Seeking: The weapon's owner whispers the name of its target before shooting this +1 arrow, and the weapon seeks them out, turning as many corners as necessary up to its maximum range. The weapon cannot bypass doors, though it would break through a window.

Arrow of Slaying: This *+1 arrow* is keyed to a particular creature chosen by its maker. If it strikes such a creature, the target must make a saving throw or die instantly.

Arrow of Sleep: This *+1 arrow* is painted white and has white fletching. If it strikes a foe so that it would normally deal damage, it instead forces the target to make a saving throw or fall asleep.

Assassin's Dagger: This wicked-looking, curved *+2 dagger* provides a -1 penalty to the saving throw against the backstab death attacks of an assassin.

Axe of Throwing: This *+2 handaxe* has double the normal range of a normal hand axe.

Bow of Magic Missiles: This +2 *longbow* is unstrung. Rather than fire arrows, it fires *magic missiles* that appear when makes the motion of pulling back an arrow. These *magic missiles* require a ranged attack roll to hit, and deal 1d6+1 points of damage. This is arcane energy damage to which nothing has resistance or immunity. In addition, the eldritch darts can be used to perform combat maneuvers at a range of up to 30'.

Club of Smashing: This +2 *club* deals and extra 2d6 points of damage to structures, including doors, walls, and portcullises. It creates the equivalent of a *stomp* spell once per day when struck on the ground.



Crossbow of Distance: This +1 *light crossbow's* range is double that of a normal light crossbow.

Crossbow of Speed: The wielder of this +1 *light crossbow* can attack twice per round with it.

Crystal Sword: Crystal swords come in four colors, blue, red, green and purple. A *crystal sword* is cut from a single piece of crystal. It gives off a brilliant glow (double torch illumination) when drawn and strikes as a +2 *short sword*. Two times per day it can cast a spell based on its color, *calm emotion* if blue, *rage* if red and *crushing despair* if purple. All creatures within 10' of the wielder must save vs. spell. The first time this spell is cast, the sword loses some enchantment, becoming a +1 *short sword* and giving off a glow no brighter than a torch. The second time the spell is cast the sword loses its +1 enchantment and no longer glows. This sword's magic bonus returns to normal (+2) after the wielder has had a full night's sleep.

Dastard's Dagger: This +1 *dagger*, in the hands of a thief, increases backstab damage by 1d6.

Glavius: A *glavius* is a three-bladed throwing weapon. It strikes as a +2 *dart* than can be mentally commanded to attack on its own once per day for 3 rounds using your attack bonus. It always returns to its thrower if possible. Outsiders killed by a *glavius* do not return to their home plane after death to regenerate as long as the blade is left stuck in their corpse.

Hammer of Thunderbolts: This +2 *warhammer* creates a cacophonous roar like thunder upon striking on a natural attack roll of '20'. A *hammer of thunderbolts* deals

an extra 1d8 points of sonic damage and the victim must pass a saving throw or be deafened permanently.

Javelin of Lightning: This +1 *javelin* becomes a 5d6 *lightning bolt* when thrown. It is consumed in the attack.

Mace of Disruption: This +1 *footman's mace* is the bane of all undead. Any undead creature struck by the mace in combat must succeed on a saving throw or be destroyed.

Mace of Smiting: This +3 *footman's mace* has a +5 bonus to attack and damage constructs, and any natural '20' attack roll against a construct destroys it.

Net of Entangling: This +1 *net* expands to entangle even huge monsters, though nothing larger than 30' tall or long. Once inside a *net of entangling*, creatures suffer a -2 penalty to escape.

Power Sword: This +2 *longsword* can, upon speaking the command phrase "The power is mine!" bestows the spell *transformation* on the wielder. The sword can do this up to two times per day.

Silver Dagger: This silver dagger is non-magical.

Spell Storing Dagger: This +1 *dagger* allows a spell caster to store a single spell of up to 3rd level in the weapon. Any time the weapon strikes a creature and the creature takes damage from it, the weapon can immediately cast the spell on that creature if the wielder desires. Once the spell has been cast from the weapon, a spell caster can cast any other spell of up to 3rd level into it. The weapon magically imparts to the wielder the name of the spell currently stored within it.

Sun Blade: This sword is the size of a bastard sword. However, a *sun blade* is wielded as if it were a short sword with respect to weight and ease of use. In normal combat, the glowing golden blade of the weapon is equal to a +2 *bastard sword*. Against Chaotic creatures, its bonus is +4. Against undead creatures, the sword deals an extra dice points of damage.

Once per day, the wielder can swing the blade vigorously above her head while speaking a command word. The *sun blade* then sheds a bright yellow radiance that is like full daylight. The radiance begins shining in a 10-foot radius around the sword wielder and extends outward at 5' per round for 10 rounds thereafter, to create a globe of light with a 60-foot radius. When the wielder stops swinging, the radiance fades to a dim glow that persists for another minute before disappearing entirely. All sun blades are of Lawful (NG) alignment, and any Chaotic creature attempting to wield one loses one level.

Sword of the Planes: This longsword has a magic bonus of +1 on the Material Plane, but on any Elemental Plane its bonus increases to +2. It operates as +3 on the Astral or the Ethereal Plane or when used against opponents native to either of those planes. On any other plane or against any outsider it functions as a +4 longsword.

Sword of Wounding: This +2 longsword deals an extra 1 point of damage from blood loss when it hits a creature. Creatures continue to lose 1 hit point each round until they are healed with magic, or have their wounds bound.

Sylvan Scimitar: This +3 scimitar deals an extra 1d6 points of damage when used outdoors.

Trident of Fish Command: The magical properties of this +1 trident enable its wielder to charm up to 14 HD of aquatic animals within 30'. The wielder can use this effect three times per day. The wielder can communicate with the animals as if using *Speak with Animals*. Animals making a saving throw are free of control, but they will not approach within 10' of the trident. The trident can be used up to three times per day.

Trident of Warning: This +2 trident enables its wielder to determine the location, depth, kind and number of aquatic predators within 680'. A *trident of warning* must be grasped and pointed in order for the character using it to gain such information, and it requires 1 round to scan a hemisphere with a radius of 680'.

Vorpal Sword: This +1 longsword allows the weapon to sever the heads of those it strikes. Upon a roll of natural '20', the weapon severs the opponent's head (if it has one) from its body. When taking a head, it makes a sound like snicker-snack.

Intelligent Weapons

1% of magic weapons possess sentience, and thus intelligence, alignment and ego. Intelligent items cannot be created on purpose by spellcasters. Rather, when a magic weapon is created, there is a 1% chance that it possesses an innate intelligence.

Unlike most magic items, intelligent weapons can activate their own powers without waiting for a command word from their owner. Intelligent items act during their owner's turn in the initiative order.



Intelligent Item Alignment

Intelligent weapons have an alignment.

d6	Alignment	1-2	3-4	5-6
1-3	Lawful	LG	NG	CG
4-5	Neutral	LN	N	CN
6	Chaotic	LE	NE	CE

Any character whose alignment does not correspond to that of the item (except as noted) loses one level to energy drain if he or she so picks up the item. If the alignment is opposite to the character, they lose 2 levels.

How Intelligent

The weapon's intelligence determines its extra abilities as well as its means of communication.

Int.	Communication	Powers
1-6	None	None
7	Empathy	1 lesser
8	Empathy	2 lesser
9	Empathy	3 lesser
10	Speech	3 lesser
11	Speech	3 lesser + <i>read magic</i>
12	Telepathy	3 lesser + 1 greater + <i>read magic</i>

Intelligent Item Powers

The table above determines how many lesser and greater powers an intelligent item has. To find the item's specific powers, roll on the appropriate tables below.

d20	Lesser Power
1-3	Note shifting walls & rooms as dwarf
4-6	Detect sloping passages as dwarf
7-8	Find secret doors as elf
9-10	Detect traps
11-12	Detect invisibility
13-14	Detect evil and gold
15-16	Detect food and water
17	Detect magic
18	Detect gems
19	Take two rolls ignoring this result
20	Roll a greater ability

d20	Greater Power
1-4	<i>Clairsentience</i> 3/day
5-6	<i>ESP</i> 3/day
7-8	<i>Message</i> 3/day
9-10	<i>Telekinesis</i> 1/day
11-12	<i>Teleport</i> 1/day
13	X-ray vision (as ring) 1/day
14	<i>Phantasmal force II</i> 1/day
15	<i>Levitate</i> 3/day
16	<i>Fly</i> 1/day
17	<i>Cure light wounds</i> 1/day
18	<i>Strength</i> 1/day
19	Roll twice, ignoring rolls of 19 or higher
20	Roll thrice, ignoring rolls of 20 or higher

If the same power is rolled twice, roll again.

Special Purpose Items

10% of intelligent items have a special purpose. Use the following table to determine an item's special purpose.

d10	Special Purpose
1	Slay diametrically opposed alignment*
2	Slay magic-users, sorcerers and magic-using monsters
3	Slay clerics, druids and outsiders
4	Slay non-spell casters
5	Slay a particular creature type (e.g. dragons, giants, etc.)
6	Slay a particular race (e.g. dwarves, hobgoblins, etc.)
7	Defend a particular race
8	Slay the servants of a specific deity
9	Defend the servants and interests of a specific deity
10	Slay all living things (other than the wielder)

* The purpose of the Neutral version of this item is to preserve the balance by defeating/slaying powerful beings of the other alignments.

An item's purpose must suit the type and alignment of the item and should always be treated reasonably. A purpose of "defeat/slay spell casters" doesn't mean that the sword forces the wielder to kill every magic-user she sees. Nor does it mean that the sword believes it is possible to kill every magic-user, sorcerer, and bard in the world. It does mean that the item hates spell casters and wants to bring the local wizard's cabal to ruin, as well as end the rule of a sorceress-queen in a nearby land. Likewise, a purpose of "defend elves" doesn't mean that if the wielder is an elf, he only wants to help himself. It means that the item wants to be used in furthering the cause of elves, stamping out their enemies and aiding their leaders.

Intelligent Item Ego

Ego is a measure of the total power and force of personality that an intelligent weapon possesses. An intelligent weapon's ego is equal to its intelligence + 1d12 + 1 per greater power.

When the sword's goals and the wielder's goals do not coincide, there is a power struggle. Compare the sword's Ego to the wielder's Ego, which is equal to her Intelligence + Wisdom. If the character is healthy, add 1d6 to their Ego. If they have lost more than half of their hit points or are diseased or poisoned, deduct 1d6 from their Ego.

If the difference between the scores is 6 or more, the higher score is in control.

If the difference between the scores is 2 to 5, there is a 75% chance the higher score prevails.

If the difference between the scores is 0 to 1, there is a 50% chance the wielder prevails.

An intelligent item that is not controlled will not function for the owner.

Potions and Oils

A potion is a magic liquid that produces its effect when imbibed. Magic oils are similar to potions, except that oils are applied externally rather than imbibed. A potion or oil can be used only once.

A typical potion or oil consists of 1 ounce of liquid held in a ceramic or glass vial fitted with a tight stopper. The container is usually no more than 1 inch wide and 2 inches high. In addition to the magical methods of identification, adventurers can sample from each container they find to attempt to determine the nature of the liquid inside. An experienced character learns to identify potions by memory.

There is a 1% chance that a potion actually does the reverse of what it is supposed to do. Likewise, there is a 1% chance that the potion appears to be magical, but actually has no magical effects



Potions and Oils

d%	Potion
01-03	<i>Charm animal</i>
04-05	<i>Charm monster (dragons)</i>
06-07	<i>Charm monster (monsters)</i>
08-09	<i>Charm monster (plants)</i>
10-11	<i>Charm monster (undead)</i>
12-14	<i>Charm person</i>
15-17	<i>Clairsentience</i>
18-20	<i>Darkvision</i>
21-23	<i>Enlarge (self)</i>
24-26	<i>ESP</i>
27-29	<i>Etherealness (oil)</i>
30-32	<i>Extra-healing (cure serious wounds)</i>
33-35	<i>Fly</i>
36-38	<i>Gaseous form</i>
39-41	<i>Grease (oil)</i>
42-44	<i>Haste</i>
45-47	<i>Healing (cure light wounds)</i>
48-50	<i>Heroism</i>
51-53	<i>Jump</i>
54-56	<i>Levitation</i>
57-59	<i>Locate object</i>
60-61	<i>Longevity</i>
62-63	<i>Poison</i>
64-66	<i>Polymorph self</i>
67-69	<i>Purify food and drink</i>
70-72	<i>Reduce (self)</i>
73-75	<i>Resistance to energy (acid)</i>
76-78	<i>Resistance to energy (cold)</i>
79-81	<i>Resistance to energy (electricity)</i>
82-84	<i>Resistance to energy (fire)</i>
85-87	<i>Resistance to energy (sonic)</i>
88-90	<i>Spider climb</i>
91-93	<i>Stoneskin</i>
94-96	<i>Strength</i>
97-00	<i>Water breathing</i>

Potion of Longevity: A drink of this potion reduces one's age by 10 years.

Rings of Power

Rings bestow magical powers upon their wearers. Only a rare few have charges. Anyone can use a ring. A character can only effectively wear one magic ring. A second magic ring does not work if the wearer is already wearing a magic ring.

Although exceptions exist that are crafted from glass or bone, the vast majority of rings are forged from metal, usually precious metals.

A ring's ability is usually activated by a command word or it works continually. Some rings have exceptional activation methods (see below).

d%	Ring	Value
01-03	<i>Protection +1</i>	2,000 gp
04-06	<i>Feather falling</i>	2,200 gp
07-09	<i>Sustenance</i>	2,500 gp
10-12	<i>Climbing</i>	2,500 gp
13-15	<i>Jumping</i>	2,500 gp
16-18	<i>Swimming</i>	2,500 gp
19-21	<i>Counterspells</i>	4,000 gp
22-24	<i>Mind shielding</i>	8,000 gp
25-27	<i>Protection +2</i>	8,000 gp
28-30	<i>Force shield</i>	8,500 gp
31-33	<i>Ram</i>	8,600 gp
34-36	<i>Animal friendship</i>	10,800 gp
37-39	<i>Energy resistance</i>	12,000 gp
40-42	<i>Chameleon power</i>	12,700 gp
43-45	<i>Water walking</i>	15,000 gp
46-48	<i>Protection +3</i>	18,000 gp
49-51	<i>Spell storing I</i>	18,000 gp
52-54	<i>Invisibility</i>	20,000 gp
55-57	<i>Wizardry I</i>	20,000 gp
58-60	<i>X-ray vision</i>	25,000 gp
61-63	<i>Blinking</i>	27,000 gp
64-66	<i>Meld into Stone</i>	27,000 gp
67-69	<i>Protection +4</i>	32,000 gp
70-72	<i>Wizardry II</i>	40,000 gp
73-75	<i>Free action</i>	40,000 gp
76-78	<i>Friend shield (pair)</i>	50,000 gp
79-81	<i>Protection +5</i>	50,000 gp
82-84	<i>Shooting stars</i>	50,000 gp
85-87	<i>Spell storing II</i>	50,000 gp
88-89	<i>Wizardry III</i>	70,000 gp
90	<i>Telekinesis</i>	75,000 gp
91	<i>Regeneration</i>	90,000 gp
92	<i>Three wishes</i>	97,950 gp
93	<i>Spell turning</i>	98,280 gp
94	<i>Wizardry IV</i>	100,000 gp
95	<i>Djinni calling</i>	125,000 gp
96	<i>Elemental command (air)</i>	200,000 gp
97	<i>Elemental command (earth)</i>	200,000 gp
98	<i>Elemental command (fire)</i>	200,000 gp
99	<i>Elemental command (water)</i>	200,000 gp
00	<i>Spell storing III</i>	200,000 gp

Animal Friendship: On command, this ring affects an animal as if the wearer had cast *charm animal*.

Blinking: On command, this ring makes the wearer *blink* as the spell.

Chameleon Power: The wearer of this ring gains the ability to magically blend in with her surroundings. This provides a +5 bonus on her hide in shadows checks. She can also command the ring to utilize the spell *change self* as often as she wants.

Climbing: This ring is actually a magic leather cord that ties around a finger. The wearer can climb at a speed of 20' per round and only has a 1 in 6 chance of falling when climbing sheer surfaces.

Counterspells: This ring might seem to be a *ring of spell storing* upon first examination. However, while it allows a single spell of 1st through 6th level to be cast into it, that spell cannot be cast out of the ring again. Instead, should that spell ever be cast upon the wearer, the spell is immediately negated. Once so used, the spell cast within the ring is gone and can be replaced.

Djinni Calling: One of the many rings of fable, this "genie" ring is most useful indeed. It serves as a special gate by means of which a specific djinni can be called from the Elemental Plane of Air. When the ring is rubbed, the call goes out and the djinni appears on the next round. The djinni faithfully obeys and serves the wearer of the ring, but never for more than 1 hour per day. If the djinni of the ring is ever killed, the ring becomes non-magical and worthless.

Elemental Command: All four kinds of elemental command rings are very powerful. Each appears to be nothing more than a lesser magic ring until fully activated (by meeting a special condition, such as single-handedly slaying an elemental of the appropriate type or exposure to a sacred material of the ring's element), but each has certain other powers as well as the following common properties.

Elementals of the plane to which the ring is attuned cannot attack the wearer or even approach within 5' of him. If the wearer desires, he may forego this protection and instead attempt to charm the elemental (as *charm monster*). If the charm attempt fails, however, absolute protection is lost and no further attempt at charming can be made.

Creatures from the plane to which the ring is attuned who attack the wearer take a -1 penalty on their attacks. The ring wearer makes saving throws from the creature's attacks with a +2 bonus. He gains a +4 bonus on all attack rolls against such creatures. Any weapon he uses bypasses the weapon resistance of such creatures.

The wearer of the ring is able to converse with creatures from the plane to which his ring is attuned. These creatures recognize that he wears the ring. They show a healthy respect for the wearer if alignments are similar. If alignments are opposed, creatures fear the wearer if he is strong. If he is weak, they hate and desire to slay him.

The possessor of a ring of elemental command takes a saving throw penalty as follows:

Element	Saving Throw Penalty
Air	-2 against earth-based effects
Earth	-2 against air- or electricity-based effects
Fire	-2 against water- or cold-based effects
Water	-2 against fire-based effects

In addition to the powers described above, each ring gives its wearer special abilities according to its kind.

Ring of Air Elemental Command: *Feather fall* (at will), resistance to electricity, *gust of wind* (2/day), *wind wall* (at will), *air walk* (1/day), *chain lightning* (1/week). The ring appears to be a *ring of feather falling* until a certain condition set by the Treasure Keeper is met to activate its full potential.

Ring of Earth Elemental Command: *Meld into stone* (at will), *soften earth or stone* (at will), *stone shape* (2/day), *stoneskin* (1/week), *passwall* (2/week), *wall of stone* (1/day). The ring appears to be a *ring of meld into stone* until a special condition is met.

Ring of Fire Elemental Command: Resistance to fire, *burning hands* (at will), *flaming sphere* (2/day), *pyrotechnics* (2/day), *wall of fire* (1/day), *flame strike* (2/week). The ring appears to be a *ring of fire resistance* until an established condition is met.

Ring of Water Elemental Command: *Water walk* (at will), *create water* (at will), *water breathing* (at will), *wall of ice* (1/day), *ice storm* (2/week), *control water* (2/week). The ring appears to be a *ring of water walking* until an established condition is met.

Energy Resistance: This reddish iron ring continually protects the wearer from damage from one type of energy, acid, cold, electricity, fire or sonic, cutting such damage in half when suffered.

Feather Falling: This ring is crafted with a feather pattern all around its edge. It acts like a *feather fall* spell, activated if the wearer falls more than 5'.

Force Shield: An iron band, this ring generates a shield-sized and shaped *wall of force* that stays with the ring and can be wielded by the wearer as if it were a shield.

Free Action: This gold ring allows the wearer to act as if under the effect of a *free action* spell.

Friend Shield: These curious rings always come in pairs. A *friend shield ring* without its mate is useless. Either wearer of one of a pair of the rings can, at any time, command his or her ring to cast a *shield other* spell with the wearer of the mated ring as the recipient.

Invisibility: By activating this simple silver ring, the wearer can benefit from *invisibility*, as the spell.

Jumping: This ring allows the wearer to jump 30' forward, 10' backward or straight up.

Meld into Stone: This ring allows the wearer to use the spell *meld into stone* on command.

Mind Shielding: This ring is of fine workmanship and wrought from heavy gold. The wearer is continually immune to *ESP*, *detect lie* and any attempt to magically discern her alignment.

Protection: This ring offers continual magical protection in the form of a bonus of +1 to +5 to Armor Class.

Ram: The *ring of the ram* is an ornate ring forged of hard metal, usually iron or an iron alloy. It has the head of a ram as its device. The wearer can command the ring to project a force manifested as a vaguely discernible shape that resembles the head of a ram or a goat. This force strikes a single target, dealing 1d6 points of damage if 1 charge is expended, 2d6 points if 2 charges are used, or 3d6 points if 3 charges (the maximum) are used. Treat this as a ranged attack with a 50-foot maximum range and no penalties for distance.

Those struck by the ring are subject to a bull rush attack if within 30' of the ring-wearer. The ram is +7 to attack. The ram gains a +1 bonus on the attack if 2 charges are used or +2 if 3 charges are expended.

In addition to its attack mode, the ring of the ram also has the power to open doors on a roll of 1-5 on 1d6. If 2 charges are expended, doors are opened on a roll of 1-7 on 1d8. If 3 charges are expended, doors are opened on a roll of 1-9 on 1d10.

A newly created ring has 10 charges. When the charges are expended, the ring becomes a non-magical item.

Regeneration: This white gold ring allows a living wearer to heal 1 point of damage every hour. If the wearer loses a limb, an organ, or any other body part while wearing this ring, the ring regenerates it (as the *regenerate* spell). In either case, only damage taken while wearing the ring is regenerated.

Shooting Stars: This ring has two modes of operation, one in shadowy darkness or outdoors at night and a second when underground or indoors at night.

During the night under the open sky or in areas of shadow or darkness, the *ring of shooting stars* can perform the following functions: *Dancing lights* (1/hour), *light* (2/night), *ball lightning* (1/night, see below) and *shooting stars* (3/week, see below).

The first special function, ball lightning, releases one to four balls of lightning (ring wearer's choice). These glowing globes resemble dancing lights and the ring wearer controls them in the same fashion. The spheres have a 120-foot range and last for four rounds. They can be moved at 120' per round. Each sphere is about 3' in diameter and any creature that comes within 5' of one causes its charge to dissipate, taking electricity damage in the process.

Number of Balls	Damage per Ball
4 lightning balls	1d6 points of damage each
3 lightning balls	2d6 points of damage each
2 lightning balls	3d6 points of damage each
1 lightning ball	4d6 points of damage

Once the ball lightning function is activated, the balls can be released at any time before the sun rises.

The second special function produces three shooting stars that can be released from the ring each week, simultaneously or one at a time. They impact for 12 points of damage and explode in a 5' radius sphere for 24 points of fire damage.

Any creature struck by a shooting star takes full damage from impact plus full fire damage from the explosion unless it makes a saving throw. Creatures not struck but within the explosion ignore the impact damage and take only half damage from the explosion on a successful save. Range is 70', at the end of which the shooting star explodes unless it strikes a creature or object before that. A shooting star always follows a straight line and any creature in its path must make a save or be hit by it.

Indoors at night, or underground, the *ring of shooting stars* has the following properties: *Faerie fire* (2/day) and spark shower (1/day, special).

The spark shower is a flying cloud of sizzling purple sparks that fan out from the ring for a distance of 20' in an arc 10' wide. Creatures within this area take 2d8 points of damage each if not wearing metal armor or carrying a metal weapon. Those wearing metal armor and/or carrying a metal weapon take 4d8 points of damage.

Spell Storing I: A *minor ring of spell storing* contains up to three levels of spells that the wearer can cast. The user need not provide any material components or focus to cast the spell and they can cast them in armor. For a randomly generated ring, treat it as a scroll to determine what spells are stored in it. The ring imparts to the wearer the names of all spells currently stored within it.

Spell Storing II: As the *minor ring of spell storing* except it holds up to five levels of spells.

Spell Storing III: As the *minor ring of spell storing* except it holds up to ten levels of spells.

Spell Turning: Up to three times per day on command, this simple platinum band automatically reflects the next nine levels of spells cast at the wearer, exactly as if *spell turning* had been cast upon the wearer.

Sustenance: This ring provides its wearer life-sustaining nourishment. The ring also refreshes the body and mind, so that its wearer needs only sleep 2 hours per day to gain the benefit of 8 hours of sleep. The ring must be worn for a full week before it begins to work. If removed, the owner must wear it for another week to re-attune.

Swimming: This silver ring has a wave pattern etched into the band. It allows the wearer to swim at a speed of 50' per round.

Telekinesis: This ring allows the caster to use the spell *telekinesis* on command.

Three Wishes: This ring is set with three rubies. Each ruby stores a wish spell, activated by the ring. When a wish is used, that ruby disappears. For a randomly generated ring, roll 1d3 to determine the remaining number of rubies. When all the wishes are used, the ring becomes non-magical.

Water Walking: This opal ring allows the wearer to utilize the effects of the spell *water walk*.

Wizardry: This special ring comes in four varieties (*ring of wizardry I*, *ring of wizardry II*, *ring of wizardry III*, and *ring of wizardry IV*), all of them useful only to casters of magic-user spells. The wearer's magic spells per day are doubled for one specific spell level. A *ring of wizardry I* doubles 1st-level spells, a *ring of wizardry II* doubles 2nd-level spells, a *ring of wizardry III* doubles 3rd-level spells, and a *ring of wizardry IV* doubles 4th-level spells.

X-Ray Vision: On command, this ring gives its possessor the ability to see into and through solid matter. Vision range is 20', with the viewer seeing as if he were looking at something in normal light even if there is no illumination. X-ray vision can penetrate 1 foot of stone, 1 inch of common metal, or up to 3' of wood or dirt. Thicker substances or a thin sheet of lead blocks the vision. Using the ring is physically exhausting, causing fatigue after the first 10 minutes of use in a single day.



Rods

Rods are scepter-like devices that have unique magical powers. They do not usually have charges. Any class can employ a rod. Rods weigh about 5 pounds. They are 2' to 3' long and are made of metal. Many can strike as horseman's maces due to their sturdy construction.

d20	Rod	Value
1-2	<i>Immovable</i>	5,000 gp
3-4	<i>Metal and mineral detection</i>	10,500 gp
5	<i>Cancellation</i>	11,000 gp
6	<i>Wonder</i>	12,000 gp
7	<i>Python</i>	13,000 gp
8	<i>Flame extinguishing</i>	15,000 gp
9	<i>Viper</i>	19,000 gp
10	<i>Enemy detection</i>	23,500 gp
11	<i>Splendor</i>	25,000 gp
12	<i>Withering</i>	25,000 gp
13	<i>Thunder and lightning</i>	33,000 gp
14	<i>Negation</i>	37,000 gp
15	<i>Absorption</i>	50,000 gp
16	<i>Flailing</i>	50,000 gp
17	<i>Rulership</i>	60,000 gp
18	<i>Security</i>	61,000 gp
19	<i>Lordly might</i>	70,000 gp
20	<i>Alertness</i>	85,000 gp

Absorption: This rod acts as a magnet, drawing spells or spell-like abilities into itself. The magic absorbed must be a single-target spell or a ray directed at the character. The rod then nullifies the spell's effect and stores its potential until the wielder releases this energy in the form of her own spells. She can instantly detect a spell's level as the rod absorbs that spell's energy.

The wielder of the rod can use captured spell energy to cast any spell she has prepared of the same level, without expending the prepared spell itself.

A *rod of absorption* absorbs a maximum of fifty spell levels and can thereafter only discharge any remaining potential it might have. The rod cannot be recharged. The wielder knows the rod's remaining absorbing potential and current amount of stored energy.

Alertness: This rod is indistinguishable from a *+1 horseman's mace*. The bearer of a rod is only surprised on a roll of 1 on 1d6. If grasped firmly, the rod enables the holder to use *detect evil*, *detect good*, *detect magic*, *detect lie*, *light*, or *detect invisibility*.

If the head of a *rod of alertness* is planted in the ground and the possessor wills it to alertness, the rod senses any creature within 120' who intend to harm the rod's owner. At the same time, the rod creates the effect of a *prayer* spell upon all creatures friendly to the possessor in a 20' radius. Immediately thereafter, the rod sends forth a mental alert to these friendly creatures, warning them of possible danger from the unfriendly creature or creatures. These effects last for 10 minutes, and the rod can perform this function once per day.

Finally, the rod can be used to simulate the casting of an *animate objects* spell, utilizing 11 or fewer small objects located roughly around the perimeter of a 5-foot-radius circle centered on the rod when planted in the ground. Objects remain animated for 11 rounds. The rod can perform this function once per day.

Cancellation: This dreaded rod is a bane to magic items, for its touch drains an item of all magical properties. In such cases, contact is made by making a sunder attack. Upon draining an item, the rod itself becomes brittle and cannot be used again. Drained items are only restorable by *wish* or *miracle*. If a *sphere of annihilation* and a *rod of cancellation* negate each other, nothing can restore either of them.

Enemy Detection: This device pulses in the wielder's hand and points in the direction of any creature or creatures hostile to the bearer of the device (nearest

ones first). These creatures can be invisible, ethereal, hidden, disguised or in plain sight. Detection range is 60'. The rod can be used three times each day, each use lasting up to 10 minutes.

Flailing: Upon the command of its possessor, the rod activates, changing from a normal-seeming rod to a *+3 footman's flail*. Once per day the wielder can cause the rod to grant her a +4 bonus to Armor Class and a +4 bonus on saving throws for 10 minutes. The rod need not be in weapon form to grant this benefit.

Flame Extinguishing: This rod can extinguish medium or smaller non-magical fires with a touch. For the rod to be effective against other sorts of fires, the wielder must expend 1 or more of the rod's charges. Extinguishing a large or larger non-magical fire or a magic fire of medium or smaller size, expends 1 charge. Continual magic flames, such as those of a weapon or a fire creature, are suppressed for 6 rounds and flare up again after that time. To extinguish an instantaneous fire spell, the rod must be within the area of the effect. When applied to large or larger magic fires, extinguishing the flames expends 2 charges from the rod. If the device is used upon a fire creature, it deals 6d6 points of damage to the creature. This use requires 3 charges. A *rod of flame extinguishing* has 10 charges when found. Spent charges are renewed every day, so that a wielder can expend up to 10 charges in any 24-hour period.

Immovable Rod: This rod is a flat iron bar with a small button on one end. When the button is pushed, the rod does not move from where it is, even if this means defying gravity. Thus, the owner can lift or place the rod wherever he wishes, push the button, and let go. Two *immovable rods* can make a ladder when used together. An immovable rod can support up to 8,000 pounds before falling to the ground. If a creature pushes against an *immovable rod*, it must make a bend bars check at -10 to move the rod up to 10' in a single round.

Lordly Might: This rod has functions that are spell-like, and it can also be used as a magic weapon of various sorts. It also has several more mundane uses. The *rod of lordly might* is metal, thicker than other rods, with a flanged ball at one end and six stud-like buttons along its length. The following spell-like functions can each be used once per day.

- *Hold person.* The wielder must choose to use this power and then succeed on a melee attack to activate the power. If the attack fails, the effect is lost.

- *Fear* upon all enemies viewing it, if the wielder so desires (10-foot maximum range, save negates).

- Deal 2d4 hit points of damage to an opponent on a successful attack (save for half) and cure the wielder of a like amount of damage.

The following weapon functions of the rod have no limit on the number of times they can be employed.

- In its normal form, the rod is a *+2 horseman's mace*.
- When button 1 is pushed, the rod becomes a *+1 flaming longsword*, the blade springing from the ball.
- When button 2 is pushed, the rod becomes a *+4 battleaxe*. A wide blade springs forth at the ball, and the rod lengthens to 4'.
- When button 3 is pushed, the rod becomes a *+3 spear*. The spear blade springs from the ball, and the handle lengthens up to 12'. At its 15' length, the rod is suitable for use as a lance.

The following other functions of the rod also have no limit on the number of times they can be employed.

- Climbing pole/ladder. When button 4 is pushed, a spike that can anchor in granite is extruded from the ball, while the other end sprouts three sharp hooks. The rod lengthens to anywhere between 5' and 50' in a single round, stopping when button 4 is pushed again. Bars three inches long fold out from the sides, 1 foot apart, in staggered progression. The rod is firmly held by the spike and hooks and can bear up to 4,000 pounds. The wielder can retract the pole by pushing button 5.
- The ladder function can be used to force open doors. The wielder plants the rod's base 30' or less from the portal to be forced and in line with it, then pushes button 4. The force exerted has a strength bonus of +12.
- When button 6 is pushed, the rod indicates magnetic north and approximate depth beneath the surface or height above it.

Metal and Mineral Detection: This rod pulses in the wielder's hand and points to the largest mass of metal within 30'. However, the wielder can concentrate on a specific metal or mineral. If the specific mineral is within 30', the rod points to any places it is located, and the rod wielder knows the approximate quantity as well. If more than one deposit of the specified metal or mineral is within range, the rod points to the largest cache first. Each operation requires a full-round action.

Negation: This device negates the spell or spell-like function or functions of magic items. The wielder points the rod at the magic item, and a pale gray beam shoots forth to touch the target device, attacking as a ray. The ray functions as *dispel magic*, except it only affects magic items. The target item gets no saving throw, although the rod cannot negate artifacts. The rod can function three times per day.

Python: This rod is longer than normal rods. It is about 4' long and weighs 10 pounds. It strikes as a *+1 quarterstaff*. If the user throws the rod to the ground, it becomes a giant constrictor snake. The python obeys all commands of the owner. In animal form, it retains the +1 bonus on attacks and damage possessed by the rod form. The serpent returns to rod form whenever the wielder desires, or whenever it moves farther than 100' from the owner. If the snake form is slain, it returns to rod form and cannot be activated again for three days. A *python rod* only functions for Lawful creatures.

Rulership: This rod looks like a royal scepter worth at least 5,000 gp in materials and workmanship alone. The wielder can command the obedience and fealty of creatures within 120' when she activates the device. Creatures totaling up to 300 Hit Dice can be ruled, but creatures with intelligence scores of 12 or higher are entitled to a saving throw against the effect. The rod can be used for 500 total minutes before crumbling to dust. This duration need not be continuous.

Security: This item creates a non-dimensional space, a pocket paradise. There, the rod's possessor and 199 other creatures can stay in complete safety for up to 200 days divided by the number of creatures included. In this pocket paradise, creatures do not age and natural healing takes place at twice the normal rate. Fresh water and food (fruits and vegetables only) are in abundance. The climate is comfortable for all creatures involved.

When the rod's effect expires or is dispelled, all the affected creatures instantly reappear in the location they occupied when the rod was activated. The rod's possessor can dismiss the effect whenever he wishes before the maximum time period expires, but the rod can only be activated once per week.

Splendor: The possessor of this rod gains a +4 bonus to her charisma score for as long as she holds or carries the item. Once per day, the rod creates and garbs her in clothing of the finest fabrics, plus adornments of furs and jewels. Apparel created by the magic of the rod remains in existence for 12 hours. However, if the possessor

attempts to sell or give away any part of it, to use it for a spell component, or the like, all the apparel immediately disappears. The same applies if any of it is forcibly taken from her. The value of clothing created by this rod ranges from 7,000 to 10,000 gp (1d4+6 x 1,000 gp).

The *rod of splendor* has a second special power, usable once per week. Upon command, it creates a huge pavilion of silk 60' across. Inside the tent are temporary furnishings and food suitable to the splendor of the pavilion and sufficient to entertain as many as one hundred persons. The tent and its trappings last for one day. At the end of that time, the tent and all objects associated with it (including any items that were taken out of the tent) disappear.

Thunder and Lightning: Constructed of iron set with silver rivets, this rod has the properties of a +2 *horseman's mace*. Its other powers are as follows.

- **Thunder:** Once per day, the rod can strike as a +3 *horseman's mace* and the foe struck is stunned from the noise of the impact (save negates).
- **Lightning:** Once per day, when the wielder desires, electricity can leap forth when the rod strikes to deal an extra 2d6 points of electricity damage.
- **Thunderclap:** Once per day, the wielder can cause the rod to give out a deafening noise, as the *shout* spell.
- **Lightning Stroke:** Once per day, the wielder can cause the rod to shoot out a 5-foot-wide lightning bolt (9d6 points of electricity damage) to a range of 200'.
- **Thunder and Lightning:** Once per week, the wielder of the rod can combine the thunderclap described above with a lightning bolt, as in the lightning stroke. The thunderclap affects all within 10' of the bolt. The lightning strike deals 9d6 points of electricity damage, and the thunderclap deals 2d6 points of sonic damage. A single saving throw applies for both effects.

Viper: This rod strikes as a +2 *footman's mace*. Once per day, upon command, the head of the rod becomes that of an actual serpent for 10 minutes. During this period, any successful strike with the rod deals its usual damage and also poisons the creature hit. The poison deals 1d6 points of constitution damage per round (save negates). The rod only functions if its user is Chaotic.

Withering: A *rod of withering* acts as a +1 *horseman's mace* that does not deal hit point damage. Instead, the wielder deals 1d4 points of strength damage and 1d4 points of constitution damage to any creature she hits

with the rod. If she rolls a natural '20', the damage from that hit is ability drain. In either case, the defender negates the effect with a saving throw.

Wonder: A *rod of wonder* is a strange and unpredictable device that randomly generates any number of weird effects each time it is used.

d%	Wondrous Effect
01-05	<i>Slow</i> creature pointed at for 10 rounds
06-10	<i>Faerie fire</i> surrounds the target
11-15	Deludes wielder for 1 round into believing the rod functions as indicated by a second die roll (no save)
16-20	<i>Gust of wind</i> , but at windstorm force
21-25	Wielder learns target's surface thoughts (as with <i>ESP</i>) for 1d4 rounds (no save)
26-30	<i>Stinking cloud</i> at 30' range
31-33	Heavy rain falls for 1 round in 60' radius centered on rod wielder
34-36	Summon an animal—a rhinoceros (01-25 on d%), elephant (26-50), or mouse (51-100)
37-46	<i>Lightning bolt</i> (70' long, 5' wide), 6d6 damage
47-49	Stream of 600 large butterflies pours forth and flutters around for 2 rounds, blinding everyone (including wielder) within 25'.
50-53	<i>Enlarge person</i> if within 60' of rod
54-58	<i>Darkness</i> , 30' diameter hemisphere, centered 30' away from rod
59-62	Grass grows in 160-sq. ft. area before the rod, or grass existing there grows to ten times normal size
63-65	Turn ethereal any nonliving object of up to 1,000 lb. mass and up to 30 cu. ft. in size
66-69	Reduce wielder to one-twelfth height
70-79	<i>Fireball</i> at target or 100' straight ahead, 6d6 damage
80-84	<i>Invisibility</i> hides rod wielder
85-87	Leaves grow from target if within 60' of rod and last for 24 hours
88-90	10-40 gems, value 1 gp each, shoot forth in a 30' long stream. Each gem deals 1 point of damage to any creature in its path: Roll 5d4 for the number of hits and divide them among the available targets
91-95	Shimmering colors dance and play over a 40' by 30' area in front of rod. Creatures therein are blinded for 1d6 rounds
96-97	Wielder (50% chance) or target (50% chance) turns permanently blue, green, or purple (no save)
98-00	<i>Flesh to stone</i> (or stone to flesh if target is stone already) if target is within 60'

Scrolls

A scroll is a spell that has been stored in written form. A spell on a scroll can be used only once. The writing vanishes from the scroll when the spell is activated. Using a scroll is basically like casting a spell.

A scroll is a heavy sheet of fine vellum or high-quality paper. An area about 8 1/2 inches wide and 11 inches long is sufficient to hold one spell. The sheet is reinforced at the top and bottom with strips of leather slightly longer than the sheet is wide.

To protect it from wrinkling or tearing, a scroll is rolled up from both ends to form a double cylinder. (This also helps the user unroll the scroll quickly.) The scroll is placed in a tube of ivory, jade, leather, metal, or wood. Most scroll cases are inscribed with magic symbols which often identify the owner or the spells stored on the scrolls inside. The symbols often hide magic traps.

To activate a magic-user scroll, a spell caster must first decipher it with *read magic*, and then read it. Clerics and druids can use scrolls without deciphering them. If the spell is of a higher level than the reader can normally cast, they must pass a saving throw to avoid a scroll mishap. When a mishap occurs, the spell is reversed or has a harmful effect. Possible mishaps are given below.

- A surge of uncontrolled magical energy deals 1d6 points of damage per spell level to the scroll user.
- Spell strikes the scroll user or an ally instead of the intended target, or a random target nearby if the scroll user was the intended recipient.
- Spell takes effect at a random location within range.
- Spell's effect on the target is contrary to the spell's normal effect.
- The scroll user suffers some minor but bizarre effect related to the spell in some way. Most such effects should last only as long as the original spell's duration, or 2d10 minutes for instantaneous spells.
- Some innocuous item(s) appear in the spell's area.
- Spell has delayed effect. Sometime within the next 1d12 hours it activates. If the scroll reader was the intended recipient, the spell takes effect normally. If the reader was not the intended recipient, the spell goes off in the general direction of the original recipient or target, up to the spell's maximum range.

d%	Type
01-30	Magic-User
31-40	Cleric
41-50	Druid
51-75	Protection
76-00	Treasure Map

d20	Spell Level
1-8	1st
9-10	2nd
11-12	3rd
13-14	4th
15-16	5th
17	6th
18	7th
19	8th
20	9th

d10	Protection from ...
1	Drowning
2	Poison
3	Metal
4	Magic
5	Undead
6	Lycanthropes
7	Fey
8	Elementals
9	Aberrations
10	Outsiders

Protection scrolls can be read by any character, regardless of class. Once read, the scroll protects the reader and possibly others from a specific kind of threat.

Aberration: Everyone within a 10' radius around the reader is protected from the attacks of one aberration for a period of 40 minutes.

Drowning: Everyone within a 10' radius of the reader gains the ability to breathe underwater for 1 full day.

Elementals: Everyone within a 10' radius around the reader is protected from the attacks of one elemental for a period of 40 minutes.

Fey: Everyone within a 10' radius around the reader is protected from the attacks of one fey creature for a period of 40 minutes.

Lycanthropes: Everyone within a 10' radius around the reader is protected from the attacks of one lycanthrope for a period of 40 minutes.

Magic: An *anti-magic field* surrounds and moves with the reader for 1 hour, having a radius of 10’.

Metal: The reader is immune to damage from metal (but not from being crushed by a ton of metal) for one hour.

Outsiders: Everyone within a 10’ radius around the reader is protected from the attacks of one outsider for a period of 40 minutes.

Poison: Poison cannot harm the reader for a period of 6 hours, and any poison in his system is removed.

Undead: All within a 10’ radius of the reader are protected against undead, but only to a limited degree. In any given round, 2d12 undead with HD fewer than 4, and 2d6 undead with 4 to 5 hit dice, and 1d6 undead with 6 or more hit dice are foiled by the protection of the scroll.

Staves

A staff is a long shaft of wood that stores multiple spells. Unlike wands, which can contain a wide variety of spells, each staff is of a certain kind and holds specific spells. A staff has 10 charges when created. A typical staff is 4’ to 7’ long and 2 to 3 inches thick, weighing about 5 lb.

In the descriptions below, the number in parentheses after the name of a spell is the number of charges it takes to cast that spell.

d%	Staff	Value
01-16	<i>Charming</i>	16,500 gp
17-26	<i>Fire</i>	17,750 gp
27-36	<i>Swarming insects</i>	24,750 gp
37-46	<i>Healing</i>	27,750 gp
47-56	<i>Size alteration</i>	29,000 gp
57-61	<i>Illumination</i>	48,250 gp
62-66	<i>Frost</i>	56,250 gp
67-71	<i>Defense</i>	58,250 gp
72-74	<i>Abjuration</i>	65,000 gp
75-77	<i>Conjuration</i>	65,000 gp
78-80	<i>Enchantment</i>	65,000 gp
81-83	<i>Evocation</i>	65,000 gp
84-86	<i>Illusion</i>	65,000 gp
87-89	<i>Necromancy</i>	65,000 gp
90-92	<i>Transmutation</i>	65,000 gp
93-94	<i>Divination</i>	73,500 gp
95-96	<i>Earth and stone</i>	80,500 gp
97	<i>Woodlands</i>	101,250 gp
98	<i>Life</i>	155,750 gp
99	<i>Passage</i>	170,500 gp
00	<i>Power</i>	211,000 gp

Abjuration: Carved from the heartwood of an ancient oak or other large tree, this staff allows use of the following spells: *Shield* (1), *resist energy* (1), *dispel magic* (1), *globe of invulnerability I* (2), *dismissal* (2) and *repulsion* (3).

Charming: Made of twisting wood ornately shaped and carved, this staff allows use of the following spells: *Charm person* (1) and *charm monster* (2).

Conjuration: This staff is made of ash or walnut and bears ornate carvings of many different kinds of creatures. It allows use of the following spells: *Unseen servant* (1), *summon swarm* (1), *stinking cloud* (1), *creation I* (2), *cloudkill* (2) and *summon monster VI* (3).

Defense: The staff of defense is a simple-looking staff that throbs with power when held defensively. It allows use of the following spells: *Shield* (1), *shield of faith* (1) and *shield other* (1).

Divination: Made from a supple length of willow, often with a forked tip. A *staff of divination* allows use of the following spells: *Detect secret doors* (1), *locate object* (1), *tongues* (1), *locate creature* (2), *prying eyes* (2) and *true seeing* (3).

Earth and Stone: This staff is topped with an emerald that gleams with smoldering power. It allows the use of the following spells: *Passwall* (1) and *move earth* (1).

Enchantment: Often made from apple wood and topped with a clear crystal, this staff allows use of the following spells: *Sleep* (1), *hideous laughter* (1), *suggestion* (1), *crushing despair* (2) and *mind fog* (2).

Evocation: Very smooth and carved from hickory, willow, or yew, this staff allows use of the following spells: *Magic missile* (1), *shatter* (1), *fireball* (1), *ice storm* (2), *wall of force* (2) and *chain lightning* (3).

Fire: Crafted from bronzedwood with brass bindings, this staff allows use of the following spells: *Burning hands* (1), *fireball* (1) and *wall of fire* (2).

Frost: Tipped on either end with a glistening diamond, this rune-covered staff allows use of the following spells: *Ice storm* (1), *wall of ice* (1) and *cone of cold* (2).

Healing: This white ash staff, with inlaid silver runes, allows use of the following spells: *Cure serious wounds* (1), *cure blindness/deafness* (2) and *cure disease* (3).

Illusion: This staff is made from ebony or other dark wood and carved into an intricately twisted, fluted, or spiral shape. It allows use of the following spells: *Change self* (1), *mirror image* (1), *spectral force* (1), *rainbow pattern* (2), *persistent image* (2) and *mislead* (3).

Illumination: This staff is sheathed in silver and decorated with sunbursts. It allows use of the following spells: *Dancing lights* (1), *flare* (1), *daylight* (2) and *sunburst* (3).

Life: Made of oak shod in gold, this staff allows use of the following: *Heal* (1) and *raise dead* (5).

Necromancy: This staff is made from ebony and carved with images of skulls. It allows use of the following: *Cause fear* (1), *ghoul touch* (1), *hold undead* (1), *enervation* (2), *waves of fatigue* (2) and *circle of death* (3).

Passage: This potent item allows use of the following spells: *Dimension door* (1), *passwall* (1), *phase door* (2), *teleport without error* (2) and *astral projection* (3).

Power: The *staff of power* is a very potent magic item, with both offensive and defensive abilities. It is topped with a glistening gem, its shaft straight and smooth. It has the following powers: *Magic missile* (1), *ray of enfeeblement* (1), *continual light* (1), *levitate* (1), *lightning bolt* (2), *fireball* (2), *cone of cold* (2), *hold monster* (2), *wall of force* (2; hemisphere only) and *globe of invulnerability II* (2).

The wielder of a *staff of power* gains a +2 bonus to AC and saving throws. The staff is also a +2 *quarterstaff*, and its wielder may use it to smite opponents. If 1 charge is expended, the staff causes double damage.

A *staff of power* can be used for a retributive strike, requiring it to be broken by its wielder. All charges currently in the staff are instantly released in a 30-foot radius. All within 10' of the broken staff take points of damage equal to 8 x the number of charges in the staff, those 15 to 20' away take 6 x the number of charges in damage and those 25' to 30' distant take 4 x the number of charges in damage. All those affected can make a saving throw to reduce the damage by half.

The character breaking the staff has a 50% chance of traveling to another plane of existence, but if he does not, the explosive release of spell energy destroys him. After



all charges are used up from the staff, it remains a +2 *quarterstaff*.

Size Alteration: Stout and sturdy, this staff allows use of the following spells: *Enlarge person* (1), *reduce person* (1), and *shrink item* (1).

Swarming Insects: Made of twisted dark wood with dark spots resembling crawling insects (which some-times seem to move), this staff allows use of the following: *Summon swarm* (1) and *insect plague* (3).

Transmutation: This staff is generally carved from petrified wood and allows use of the following spells: *Expeditious retreat* (1 charge), *alter self* (1 charge), *blink* (1 charge), *polymorph* (2 charges), *polymorph other* (2 charges) and *disintegrate* (3 charges).

Woodlands: Appearing to have grown naturally into its shape, this oak, ash, or yew staff allows use of the following spells: *Charm animal* (1 charge), *speak with animals* (1 charge), *barkskin* (2 charges), *wall of thorns* (3 charges), *wall of thorns* (3 charges), *summon nature's ally VI* (3 charges) and *animate plants* (4 charges).

The staff may be used as a weapon, functioning as a +2 *quarterstaff*. The *staff of the woodlands* also allows its wielder to *pass without trace* at will, with no charge cost. These two attributes continue to function after all the charges are expended.

Wands

A wand is a thin baton about 6 to 12 inches in length. Each wand holds a single spell. A wand has 10 charges when created and each charge expended allows the user to use the wand's spell one time. A wand that runs out of charges is just a stick.

d%	Spell Level & Charges
01-45	One first level spell, 1d10 charges
46-70	One second level spell, 1d8 charges
71-90	One third level spell, 1d6 charges
91-00	One fourth level spell, 1d4 charges

d%	Spell List
01-30	Cleric
31-50	Druid
51-00	Magic-User



Wondrous Items

Wondrous Items is a catch-all category for any sort of magic item that does not fall easily into the groups above. Any character class can use a wondrous item unless specified otherwise.

Table 1

d%	Wondrous Item	Value
01	<i>Feather token, anchor</i>	50 gp
02	<i>Universal solvent</i>	50 gp
03	<i>Elixir of love</i>	150 gp
04	<i>Unguent of timelessness</i>	150 gp
05	<i>Feather token, fan</i>	200 gp
06	<i>Dust of tracelessness</i>	250 gp
07	<i>Elixir of hiding</i>	250 gp
08	<i>Elixir of sneaking</i>	250 gp
09	<i>Elixir of swimming</i>	250 gp
10	<i>Elixir of vision</i>	250 gp
11	<i>Silversheen</i>	250 gp
12	<i>Feather token, bird</i>	300 gp
13	<i>Feather token, tree</i>	400 gp
14	<i>Feather token, swan boat</i>	450 gp
15	<i>Elixir of truth</i>	500 gp
16	<i>Feather token, whip</i>	500 gp
17	<i>Dust of dryness</i>	850 gp
18	<i>Bag of tricks, gray</i>	900 gp
19	<i>Hand of the mage</i>	900 gp
20	<i>Bracers of armor +1</i>	1,000 gp
21	<i>Cloak of resistance +1</i>	1,000 gp
22	<i>Pearl of power, 1st-level spell</i>	1,000 gp
23	<i>Phylactery of faithfulness</i>	1,000 gp
24	<i>Salve of slipperiness</i>	1,000 gp
25	<i>Elixir of fire breath</i>	1,100 gp
26	<i>Pipes of the sewers</i>	1,150 gp
27	<i>Dust of illusion</i>	1,200 gp
28	<i>Lenses of minute seeing</i>	1,250 gp
29	<i>Brooch of shielding</i>	1,500 gp
30	<i>Necklace of fireballs type I</i>	1,650 gp
31	<i>Dust of appearance</i>	1,800 gp
32	<i>Hat of disguise</i>	1,800 gp

33	<i>Pipes of sounding</i>	1,800 gp
34	<i>Efficient quiver</i>	1,800 gp
35	<i>Amulet of natural armor +1</i>	2,000 gp
36	<i>Handy haversack</i>	2,000 gp
37	<i>Horn of fog</i>	2,000 gp
38	<i>Elemental gem</i>	2,250 gp
39	<i>Robe of bones</i>	2,400 gp
40	<i>Sovereign glue</i>	2,400 gp
41	<i>Bag of holding type I</i>	2,500 gp
42	<i>Boots of elvenkind</i>	2,500 gp
43	<i>Boots of the winterlands</i>	2,500 gp
44	<i>Candle of truth</i>	2,500 gp
45	<i>Cloak of elvenkind</i>	2,500 gp
46	<i>Eyes of the eagle</i>	2,500 gp
47	<i>Scarab, golembane</i>	2,500 gp
48	<i>Necklace of fireballs type II</i>	2,700 gp
49	<i>Stone of alarm</i>	2,700 gp
50	<i>Bag of tricks, rust</i>	3,000 gp
51	<i>Bead of force</i>	3,000 gp
52	<i>Chime of opening</i>	3,000 gp
53	<i>Horseshoes of speed</i>	3,000 gp
54	<i>Rope of climbing</i>	3,000 gp
55	<i>Dust of disappearance</i>	3,500 gp
56	<i>Lens of detection</i>	3,500 gp
57	<i>Vestment, druid's</i>	3,750 gp
58	<i>Figurine of wondrous power, silver raven</i>	3,800 gp
59	<i>Amulet of health 20</i>	4,000 gp
60	<i>Bracers of armor +2</i>	4,000 gp
61	<i>Cloak of charisma 20</i>	4,000 gp
62	<i>Cloak of resistance +2</i>	4,000 gp
63	<i>Gauntlets of ogre power</i>	4,000 gp
64	<i>Gloves of arrow snaring</i>	4,000 gp
65	<i>Gloves of dexterity 20</i>	4,000 gp
66	<i>Headband of intellect 20</i>	4,000 gp
67	<i>Ioun stone, clear spindle</i>	4,000 gp
68	<i>Restorative ointment</i>	4,000 gp
69	<i>Marvelous pigments</i>	4,000 gp
70	<i>Pearl of power, 2nd-level spell</i>	4,000 gp
71	<i>Periapt of wisdom 20</i>	4,000 gp
72	<i>Stone salve</i>	4,000 gp
73	<i>Necklace of fireballs type III</i>	4,350 gp
74	<i>Circlet of persuasion</i>	4,500 gp
75	<i>Slippers of spider climbing</i>	4,800 gp
76	<i>Incense of meditation</i>	4,900 gp
77	<i>Bag of holding type II</i>	5,000 gp
78	<i>Bracers of archery I</i>	5,000 gp
79	<i>Ioun stone, dusty rose prism</i>	5,000 gp
80	<i>Helm of comprehend languages</i>	5,200 gp
81	<i>Vest of escape</i>	5,200 gp
82	<i>Eversmoking bottle</i>	5,400 gp
83	<i>Sustaining spoon</i>	5,400 gp
84	<i>Necklace of fireballs type IV</i>	5,400 gp
85	<i>Boots of striding and springing</i>	5,500 gp

86	<i>Wind fan</i>	5,500 gp	35	<i>Golem manual, bone or flesh</i>	12,000 gp
87	<i>Amulet of mighty fists +1</i>	6,000 gp	36	<i>Medallion of ESP</i>	12,000 gp
88	<i>Horseshoes of a zephyr</i>	6,000 gp	37	<i>Pipes of pain</i>	12,000 gp
89	<i>Pipes of haunting</i>	6,000 gp	38	<i>Blessed book</i>	12,500 gp
90	<i>Necklace of fireballs type V</i>	6,150 gp	39	<i>Belt, monk's</i>	13,000 gp
91	<i>Gloves of swimming and climbing</i>	6,250 gp	40	<i>Gem of brightness</i>	13,000 gp
92	<i>Bag of tricks, tan</i>	6,300 gp	41	<i>Lyre of building</i>	13,000 gp
93	<i>Circlet of blasting I</i>	6,480 gp	42	<i>Cloak of arachnida</i>	14,000 gp
94	<i>Horn of goodness/evil</i>	6,500 gp	43	<i>Stone horse, destrier</i>	14,800 gp
95	<i>Robe of useful items</i>	7,000 gp	44	<i>Belt of dwarvenkind</i>	14,900 gp
96	<i>Boat, folding</i>	7,200 gp	45	<i>Periapt of wound closure</i>	15,000 gp
97	<i>Cloak of the manta ray</i>	7,200 gp	46	<i>Horn of the tritons</i>	15,100 gp
98	<i>Bottle of air</i>	7,250 gp	47	<i>Pearl of the sirens</i>	15,300 gp
99	<i>Bag of holding type III</i>	7,400 gp	48	<i>Figurine of wondrous power, onyx dog</i>	15,500 gp
00	<i>Periapt of health</i>	7,400 gp	49	<i>Amulet of health 22</i>	16,000 gp

Table 2

d%	Wondrous Item	Value			
01	<i>Boots of levitation</i>	7,500 gp	53	<i>Cloak of charisma 22</i>	16,000 gp
02	<i>Harp of charming</i>	7,500 gp	54	<i>Cloak of resistance +4</i>	16,000 gp
03	<i>Amulet of natural armor +2</i>	8,000 gp	55	<i>Gloves of dexterity 22</i>	16,000 gp
04	<i>Golem manual, wood</i>	8,000 gp	56	<i>Headband of intellect 22</i>	16,000 gp
05	<i>Hand of glory</i>	8,000 gp	57	<i>Pearl of power, 4th-level spell</i>	16,000 gp
06	<i>Ioun stone, deep red sphere</i>	8,000 gp	58	<i>Periapt of wisdom 22</i>	16,000 gp
07	<i>Ioun stone, incandescent blue sphere</i>	8,000 gp	59	<i>Scabbard of keen edges</i>	16,000 gp
08	<i>Ioun stone, pale blue rhomboid</i>	8,000 gp	60	<i>Figurine of wondrous power, golden lions</i>	16,500 gp
09	<i>Ioun stone, pink and green sphere</i>	8,000 gp	61	<i>Chime of interruption</i>	16,800 gp
10	<i>Ioun stone, pink rhomboid</i>	8,000 gp	62	<i>Broom of flying</i>	17,000 gp
11	<i>Ioun stone, scarlet and blue sphere</i>	8,000 gp	63	<i>Figurine of wondrous power, marble elephant</i>	17,000 gp
12	<i>Deck of illusions</i>	8,100 gp	64	<i>Amulet of natural armor +3</i>	18,000 gp
13	<i>Necklace of fireballs type VI</i>	8,100 gp	65	<i>Ioun stone, iridescent spindle</i>	18,000 gp
14	<i>Candle of invocation</i>	8,400 gp	66	<i>Bracelet of friends</i>	19,000 gp
15	<i>Bracers of armor +3</i>	9,000 gp	67	<i>Carpet of flying, 5' x 5'</i>	20,000 gp
16	<i>Cloak of resistance +3</i>	9,000 gp	68	<i>Horn of blasting</i>	20,000 gp
17	<i>Decanter of endless water</i>	9,000 gp	69	<i>Ioun stone, pale lavender ellipsoid</i>	20,000 gp
18	<i>Necklace of adaptation</i>	9,000 gp	70	<i>Ioun stone, pearly white spindle</i>	20,000 gp
19	<i>Pearl of power, 3rd-level spell</i>	9,000 gp	71	<i>Portable hole</i>	20,000 gp
20	<i>Talisman of the sphere</i>	9,000 gp	72	<i>Stone of good luck (luckstone)</i>	20,000 gp
21	<i>Figurine of wondrous power, serpentine owl</i>	9,100 gp	73	<i>Figurine of wondrous power, ivory goats</i>	21,000 gp
22	<i>Necklace of fireballs type VII</i>	9,150 gp	74	<i>Rope of entanglement</i>	21,000 gp
23	<i>Strand of prayer beads, lesser</i>	9,600 gp	75	<i>Golem manual, amber, clay or stone</i>	22,000 gp
24	<i>Bag of holding type IV</i>	10,000 gp	76	<i>Mask of the skull</i>	22,000 gp
25	<i>Figurine of wondrous power, bronze griffon</i>	10,000 gp	77	<i>Mattock of the titans</i>	23,348 gp
26	<i>Figurine of wondrous power, ebony fly</i>	10,000 gp	78	<i>Circlet of blasting II</i>	23,760 gp
27	<i>Glove of storing</i>	10,000 gp	79	<i>Amulet of mighty fists +2</i>	24,000 gp
28	<i>Ioun stone, dark blue rhomboid</i>	10,000 gp	80	<i>Cloak of displacement, minor</i>	24,000 gp
29	<i>Stone horse, courser</i>	10,000 gp	81	<i>Helm of underwater action</i>	24,000 gp
30	<i>Cape of the mountebank</i>	10,080 gp	82	<i>Bracers of archery II</i>	25,000 gp
31	<i>Phylactery of undead turning</i>	11,000 gp	83	<i>Bracers of armor +5</i>	25,000 gp
32	<i>Gauntlet of rust</i>	11,500 gp	84	<i>Cloak of resistance +5</i>	25,000 gp
33	<i>Boots of speed</i>	12,000 gp	85	<i>Eyes of doom</i>	25,000 gp
34	<i>Lenses of night</i>	12,000 gp	86	<i>Pearl of power, 5th-level spell</i>	25,000 gp
			87	<i>Maul of the titans</i>	25,305 gp

88	<i>Strand of prayer beads</i>	25,800 gp	36	<i>Amulet of mighty fists +3</i>	54,000 gp
89	<i>Cloak of the bat</i>	26,000 gp	37	<i>Wings of flying</i>	54,000 gp
90	<i>Iron bands of binding</i>	26,000 gp	38	<i>Cloak of etherealness</i>	55,000 gp
91	<i>Cube of frost resistance</i>	27,000 gp	39	<i>Instant fortress</i>	55,000 gp
92	<i>Helm of telepathy</i>	27,000 gp	40	<i>Manual of bodily health +2</i>	55,000 gp
93	<i>Periapt of proof against poison</i>	27,000 gp	41	<i>Manual of gainful exercise +2</i>	55,000 gp
94	<i>Robe of scintillating colors</i>	27,000 gp	42	<i>Manual of quickness in action +2</i>	55,000 gp
95	<i>Manual of bodily health +1</i>	27,500 gp	43	<i>Tome of clear thought +2</i>	55,000 gp
96	<i>Manual of gainful exercise +1</i>	27,500 gp	44	<i>Tome of leadership and influence +2</i>	55,000 gp
97	<i>Manual of quickness in action +1</i>	27,500 gp	45	<i>Tome of understanding +2</i>	55,000 gp
98	<i>Tome of clear thought +1</i>	27,500 gp	46	<i>Eyes of charming</i>	56,000 gp
99	<i>Tome of leadership and influence +1</i>	27,500 gp	47	<i>Robe of stars</i>	58,000 gp
00	<i>Tome of understanding +1</i>	27,500 gp	48	<i>Carpet of flying, 10' by 10'</i>	60,000 gp

Table 3

d%	Wondrous Item	Value			
01	<i>Dimensional shackles</i>	28,000 gp	52	<i>Hat of conjuring</i>	66,000 gp
02	<i>Figurine of wondrous power, obsidian steed</i>	28,500 gp	53	<i>Crystal ball with telepathy</i>	70,000 gp
03	<i>Drums of panic</i>	30,000 gp	54	<i>Horn of blasting, greater</i>	70,000 gp
04	<i>Ioun stone, orange</i>	30,000 gp	55	<i>Pearl of power, two spells</i>	70,000 gp
05	<i>Ioun stone, pale green prism</i>	30,000 gp	56	<i>Helm of teleportation</i>	73,500 gp
06	<i>Lantern of revealing</i>	30,000 gp	57	<i>Gem of seeing</i>	75,000 gp
07	<i>Robe of blending</i>	30,000 gp	58	<i>Robe of the archmagi</i>	75,000 gp
08	<i>Amulet of natural armor +4</i>	32,000 gp	59	<i>Mantle of faith</i>	76,000 gp
09	<i>Amulet of proof against detection and location</i>	35,000 gp	60	<i>Crystal ball with true seeing</i>	80,000 gp
10	<i>Carpet of flying, 5' x 10'</i>	35,000 gp	61	<i>Pearl of power, 9th-level spell</i>	81,000 gp
11	<i>Golem manual, iron or bronze</i>	35,000 gp	62	<i>Well of many worlds</i>	82,000 gp
12	<i>Amulet of health 24</i>	36,000 gp	63	<i>Manual of bodily health +3</i>	82,500 gp
13	<i>Belt of giant strength, major</i>	36,000 gp	64	<i>Manual of gainful exercise +3</i>	82,500 gp
14	<i>Bracers of armor +6</i>	36,000 gp	65	<i>Manual of quickness in action +3</i>	82,500 gp
15	<i>Cloak of charisma 24</i>	36,000 gp	66	<i>Tome of clear thought +3</i>	82,500 gp
16	<i>Gloves of dexterity 24</i>	36,000 gp	67	<i>Tome of leadership and influence +3</i>	82,500 gp
17	<i>Headband of intellect 24</i>	36,000 gp	68	<i>Tome of understanding +3</i>	82,500 gp
18	<i>Ioun stone, vibrant purple prism</i>	36,000 gp	69	<i>Apparatus of the crab</i>	90,000 gp
19	<i>Pearl of power, 6th-level spell</i>	36,000 gp	70	<i>Mantle of magic resistance</i>	90,000 gp
20	<i>Periapt of wisdom 24</i>	36,000 gp	71	<i>Mirror of opposition</i>	92,000 gp
21	<i>Scarab of protection</i>	38,000 gp	72	<i>Strand of prayer beads, greater</i>	95,800 gp
22	<i>Ioun stone, lavender and green ellipsoid</i>	40,000 gp	73	<i>Amulet of mighty fists +4</i>	96,000 gp
23	<i>Ring gates</i>	40,000 gp	74	<i>Eyes of petrification</i>	98,000 gp
24	<i>Crystal ball</i>	42,000 gp	75	<i>Bowl of commanding water elementals</i>	100,000 gp
25	<i>Golem manual, dragolem</i>	44,000 gp	76	<i>Brazier of commanding fire elementals</i>	100,000 gp
26	<i>Orb of storms</i>	48,000 gp	77	<i>Censer of controlling air elementals</i>	100,000 gp
27	<i>Boots of teleportation</i>	49,000 gp	78	<i>Stone of controlling earth elementals</i>	100,000 gp
28	<i>Bracers of armor +7</i>	49,000 gp	79	<i>Manual of bodily health +4</i>	110,000 gp
29	<i>Pearl of power, 7th-level spell</i>	49,000 gp	80	<i>Manual of gainful exercise +4</i>	110,000 gp
30	<i>Amulet of natural armor +5</i>	50,000 gp	81	<i>Manual of quickness in action +4</i>	110,000 gp
31	<i>Cloak of displacement, major</i>	50,000 gp	82	<i>Tome of clear thought +4</i>	110,000 gp
32	<i>Crystal ball with detect invisibility</i>	50,000 gp	83	<i>Tome of leadership and influence +4</i>	110,000 gp
33	<i>Horn of Valhalla</i>	50,000 gp	84	<i>Tome of understanding +4</i>	110,000 gp
34	<i>Crystal ball with ESP</i>	51,000 gp	85	<i>Amulet of the planes</i>	120,000 gp
35	<i>Carpet of flying, 6' x 9'</i>	53,000 gp	86	<i>Robe of eyes</i>	120,000 gp
			87	<i>Helm of brilliance</i>	125,000 gp
			88	<i>Manual of bodily health +5</i>	137,500 gp

89	<i>Manual of gainful exercise +5</i>	137,500 gp
90	<i>Manual of quickness in action +5</i>	137,500 gp
91	<i>Tome of clear thought +5</i>	137,500 gp
92	<i>Tome of leadership and influence +5</i>	137,500 gp
93	<i>Tome of understanding +5</i>	137,500 gp
94	<i>Efreeti bottle</i>	145,000 gp
95	<i>Amulet of mighty fists +5</i>	150,000 gp
96	<i>Chaos diamond</i>	160,000 gp
97	<i>Cubic gate</i>	164,000 gp
98	<i>Iron flask</i>	170,000 gp
99	<i>Mirror of mental prowess</i>	175,000 gp
00	<i>Mirror of life trapping</i>	200,000 gp

Amulet of Health: This amulet is a golden disk on a chain. It bears the image of a lion or other powerful animal. It grants the wearer a constitution of 20 (+5 modifier), 22 (+7 modifier) or 24 (+9 modifier).

Amulet of Mighty Fists: This amulet grants a bonus of +1 to +5 on attack and damage rolls with unarmed attacks and natural weapons.

Amulet of Natural Armor: This amulet, crafted from bone or beast scales, toughens the wearer's body and flesh, giving him an armor bonus of from +1 to +5.

Amulet of the Planes: This device appears to be a black circular amulet, although any character looking closely at it sees a dark, moving swirl of color. The amulet allows its wearer to utilize the *plane shift* spell. However, this is a difficult item to master. The user must roll 1d20 below their intelligence score in order to get the amulet to take her to the plane (and the specific location on that plane) that she wants. If she fails, the amulet transports her and all those traveling with her to a random location on that plane (01–60) or to a random plane (61–100).

Amulet of Proof against Detection and Location: This silver amulet protects the wearer from scrying and magical detection just as a *non-detection* spell does.

Apparatus of the Crab: This item appears to be a large, sealed iron barrel, but it has a secret catch that opens a hatch in one end. Anyone who crawls inside finds ten unlabeled levers: The device has the following stats: Large Construct; HD 12 (200 hp); AC 20; ATK 2 Pincers 2d8; MV 20' (S20').

Lever	Lever Function
1	Extend/retract legs and tail
2	Uncover/cover forward porthole
3	Uncover/cover side portholes
4	Extend/retract pincers and feelers
5	Snap pincers
6	Move forward/backward
7	Turn left/right
8	Open or close "eyes" with <i>continual light</i> inside
9	Rise/sink in water
10	Open/close hatch

A person can pull one lever per round. Since two people can fit inside, the apparatus can move and attack in the same round. The device can function in water up to 900' deep. It holds enough air for a crew of two to survive 1d4+1 hours (twice as long for a single occupant).

Bag of Holding: This appears to be a common cloth sack about 2' by 4' in size. The *bag of holding* opens into a non-dimensional space: Its inside is larger than its outside dimensions. Regardless of what is put into the bag, the bag weighs a fixed amount. This weight and the limits in weight and volume of the bag's contents depend on the bag's type, as shown on the table below.

Bag	Wt.	Wt. Limit	Vol. Limit	Value
Type I	15 lb.	250 lb.	30 cu. ft.	2,500 gp
Type II	25 lb.	500 lb.	70 cu. ft.	5,000 gp
Type III	35 lb.	1,000 lb.	150 cu. ft.	7,400 gp
Type IV	60 lb.	1,500 lb.	250 cu. ft.	10,000 gp

If the bag is overloaded or if sharp objects pierce it (from inside or outside), the bag ruptures and is ruined and all contents are lost forever. If a bag of holding is turned inside out, its contents spill out, unharmed, but the bag must be put right before it can be used again. If living creatures are placed within the bag, they can survive for up to 10 minutes, after which time they suffocate. Retrieving a specific item from a bag of holding takes a full round.

If a *bag of holding* is placed within a *portable hole* a rift to the Astral Plane is torn in the space: Bag and hole alike are sucked into the void and forever lost. If a *portable hole* is placed within a *bag of holding*, it opens a gate to the Astral Plane: The hole, the bag, and any creatures within a 10' radius are drawn there, destroying the *portable hole* and bag of holding in the process.

Bag of Tricks: This small sack appears normal and empty. However, anyone reaching into the bag feels a small, fuzzy ball. If the ball is removed and tossed up to

20' away, it turns into an animal. The animal serves the character who drew it from the bag for 10 minutes (or until slain or ordered back into the bag), at which point it disappears. It can follow any basic commands.

Each of the three kinds of *bags of tricks* produces a different set of animals. Use the following tables to determine what animals can be drawn out of each. The heavy warhorse appears with harness and tack and accepts the character that drew it as a rider.

Animals produced are always random, and only one may exist at a time. Up to ten animals can be drawn from the bag each week.

Grey Bag		Rust Bag		Tan Bag	
d10	Animal	d10	Animal	d10	Animal
1-2	Bat	1-3	Wolverine	1-2	Brown bear
3-4	Rat	4-6	Wolf	3-4	Lion
5-6	Cat	7-8	Boar	5-6	Warhorse
7-8	Weasel	9-10	Black bear	7-8	Tiger
9-10	Badger			9-10	Rhinoceros

Bead of Force: This small black sphere appears to be a lusterless pearl. You can throw it up to 60'. Upon sharp impact, the bead explodes, sending forth a burst that deals 5d6 points of force damage to all creatures within a 10' radius. It then creates a *resilient sphere* with a duration of 10 minutes that traps all creatures in a 10' radius. The explosion consumes the bead.

Belt, Monk's: When this rope belt is wrapped around a character's waist it confers great skill in unarmed combat. The wearer's AC and unarmed damage is treated as though a monk of five levels higher (or a 5th level monk if the character is not already a monk).

Belt of Dwarvenkind: This belt gives the wearer a +3 reaction bonus with dwarves, a +1 reaction bonus with gnomes and halflings, and a -2 reaction penalty when dealing with anyone else. The wearer can understand, speak, and read dwarven. If the wearer is not a dwarf, he gains 60' darkvision, the dwarf's special underground senses, a +2 bonus to constitution (max. 18 for non-dwarves, max. 20 for dwarves) and a +2 bonus on saving throws against poison and magic.

Belt of Giant Strength: This wide belt is made of thick leather and studded with iron. The belt changes the wearer's strength score depending on the type of belt:

d10	Belt	Strength	Modifier
1-4	Hill Giant	20	+5
5-6	Stone Giant	21	+6
7	Fire Giant	22	+7
8	Frost Giant	23	+8
9	Cloud Giant	24	+9
10	Storm Giant	25	+10

Blessed Book: This well-made tome is no more than 12 inches tall, 8 inches wide and 1 inch thick. All such books are durable, waterproof, bound with iron overlaid with silver, and locked. A magic-user can fill the 1,000 pages of a *blessed book* with spells without paying the normal cost. This book is never found as randomly generated treasure with spells already inscribed in it.

Boat, Folding: A folding boat looks like a small wooden box, about 12 inches long, 6 inches wide, and 6 inches deep. It can be used to store items like any other box. If a command word is given, however, the box unfolds itself to form a boat 10' long, 4' wide, and 2' deep. A second command word causes it to unfold to a ship 24' long, 8' wide, and 6' deep. Any objects formerly stored in the box now rest inside the boat or ship.

In its smaller form, the boat has one pair of oars, an anchor, a mast, and a lateen sail. In its larger form, the boat has a deck, single rowing seats, five sets of oars, a steering oar, an anchor, a deck cabin, and a mast with a square sail. The boat can hold four people comfortably, while the ship carries fifteen with ease.

A third word of command causes the boat or ship to fold itself into a box once again.

Boots of Elvenkind: These soft boots enable the wearer to move quietly in virtually any surroundings, granting a +3 bonus on move silently checks.

Boots of Levitation: On command, these leather boots allow the wearer to *levitate*.

Boots of Speed: The wearer can click her boot heels together, enabling her to act as though affected by a *haste* spell for up to 10 rounds each day. The duration of the *haste* effect need not be consecutive rounds.

Boots of Striding and Springing: These boots increase the wearer's land movement rate by 10' per round. In addition to this striding ability, they allow the wearer to jump 30' horizontally or 10' vertically.

Boots of Teleportation: Any character wearing this footwear may *teleport* three times per day.

Boots of the Winterlands: This footwear bestows many powers upon the wearer. First, he is able to travel across snow at his normal speed, leaving no tracks. The boots also enable him to travel at normal speed across the most slippery ice (horizontal surfaces only, not vertical or sharply slanted ones) without falling or slipping. Finally, *boots of the winterlands* warm the wearer as if he were affected by an *endure elements* spell.

Boots, Winged: On command, these boots sprout wings at the heel and let the wearer fly, without having to maintain concentration, as if affected by a *fly* spell. He can fly three times day for up to 5 minutes per flight.

Bottle of Air: This item appears to be a normal glass bottle stoppered with a cork. When taken to any airless environment it retains air within it at all times, continually renewing its contents. This means that a character can draw air out of the bottle to breathe. The bottle can even be shared by multiple characters that pass it around.

Bowl of Commanding Water Elementals: This large container is fashioned from blue or green jade. It is about 1' in diameter, 6 inches deep, and relatively fragile. When the bowl is filled with fresh water and certain words are spoken a large water elemental appears. If salt water is used, the elemental is huge. In all ways the bowl functions as the *summon monster* spell. Only one elemental can be called at a time. A new elemental requires the bowl to be filled with new water, which cannot happen until after the first elemental is dispelled, dismissed, or slain.

Bracelet of Friends: This silver charm bracelet has four charms upon it when created. The owner may designate one person known to him to be keyed to one charm. When a charm is grasped and the name of the keyed individual is spoken, that person is called to the spot along with his or her gear, as long as the owner and the called person are on the same plane. The keyed individual knows who is calling and the *bracelet of friends* only functions on willing travelers. Once a charm is activated, it disappears. Charms separated from the bracelet are worthless. A bracelet found with fewer than four charms is worth 25% less for each missing charm.

Bracers of Archery I: These wristbands look like normal protective wear. The bracers empower the wearer to use any bow (not including crossbows) as if their class allowed it. If their class already allows it, she gains a +1

bonus on attack rolls whenever using that type of bow. Both bracers must be worn for the magic to be effective.

Bracers of Archery II: As the *bracers of archery I*, except the bonus is +2 to attack and +1 to damage.

Bracers of Armor: These items appear to be wrist or arm guards. They surround the wearer with an invisible but tangible field of force, granting him an armor bonus of +1 to +8, just as though he were wearing armor. Both bracers must be worn for the magic to be effective.

Brazier of Commanding Fire Elementals: This device appears to be a normal container for holding burning coals. When a fire is lit in the brazier and the proper summoning words are spoken, a large fire elemental appears. In all ways the brazier functions as the *summon monster* spell. If brimstone is added, the elemental is huge. Only one elemental can be summoned at a time. A new elemental requires a new fire which cannot be lit until first elemental is dispelled, dismissed, or slain.

Brooch of Shielding: This appears to be a piece of silver or gold jewelry used to fasten a cloak or cape. In addition to this mundane task, it can absorb *magic missiles*. A brooch can absorb up to 101 points of damage from *magic missiles* before it melts and becomes useless.

Broom of Flying: This broom is able to fly through the air for up to 9 hours per day split up as its owner desires. The broom can carry 200 pounds and fly at a speed of 40' per round, or up to 400 pounds at a speed at 30' per round. In addition, the broom can travel alone to any destination named by the owner as long as she has a good idea of the location and layout of that destination. It comes to its owner from as far away as 300 yards when she speaks the command word.

Candle of Invocation: Each of these special tapers is dedicated to one of the three main alignments. Burning the candle generates a favorable aura for the individual who lit it if the candle's alignment matches theirs. Characters of the same alignment as the burning candle add a +2 bonus on attack rolls, saving throws and task checks while within 30' of the flame.

A cleric whose alignment matches the candle's operates as if two levels higher for purposes of determining spells per day if he burns the candle during or just prior to his spell preparation time. He can even cast spells normally unavailable to him, as if he were of that higher level, but only so long as the candle continues to burn. A candle burns for 4 hours.



In addition, burning a candle also allows the owner to cast a *gate* spell, the respondent being of the same alignment as the candle, but the taper is immediately consumed in the process.

It is possible to extinguish the candle by blowing it out, so users often place it in a lantern to protect it from drafts and the like. Doing this does not interfere with its magical properties.

Candle of Truth: This white tallow candle, when burned, calls into place a *zone of truth* spell in a 5-foot radius centered on the candle. The zone lasts as long as the candle burns. It takes one hour for the candle to burn down. If the candle is snuffed before that time, the effect is canceled and the candle ruined.

Cape of the Mountebank: On command, this bright red and gold cape allows the wearer to use *dimension door* once per day. When he disappears, he leaves behind a cloud of smoke, appearing in a similar fashion at his destination.

Carpet of Flying: This rug is able to fly through the air as if affected by an *overland flight* spell of unlimited duration. The size, carrying capacity, and speed of the different *carpets of flying* are shown on the table below. Beautifully and intricately made, each carpet has its own command word to activate it. If the device is within voice range, the command word activates it, whether the speaker is on the rug or not. The carpet is then controlled by spoken directions.

Size	Capacity	Movement Rate	Weight	Value
5' x 5'	200 lb.	40'	8 lb.	20,000 gp
5' x 10'	400 lb.	40'	15 lb.	35,000 gp
10' x 10'	800 lb.	40'	10 lb.	60,000 gp

Censer of Controlling Air Elementals: This 6-inch-wide, 1-inch-high perforated golden vessel resembles a thurible found in a place of worship. If it is filled with incense and lit, summoning words spoken over it summon forth a large air elemental. If *incense of meditation* is burned within the censer, the air elemental is huge. In all ways the censer functions as the *summon monster* spell. Only one elemental can be summoned at a time. A new elemental requires a new piece of incense, which cannot be lit until after the first elemental is dispelled, dismissed, or slain.

Chaos Diamond: This lustrous gemstone is uncut and about the size of a human fist. The gem grants its possessor the following powers: *Confusion*, *protection from evil II*, *unholy word* and *unholy aura*. Each power is usable 1d3 times per day. A Lawful or Neutral character that possesses a *chaos diamond* loses one level until he is shed of it.

Chime of Interruption: This instrument can be struck once every 10 minutes and its resonant tone lasts for 3 full minutes. While the chime is resonating, no spell requiring a verbal component can be cast within a 30' radius of it unless the caster can make a saving throw with a penalty equal to the spell's level.

Chime of Opening: A chime of opening is a hollow mithral tube 1 foot long. When struck, it sends forth magical vibrations that cause locks, lids, doors, valves and portals to open. The device functions against normal bars, shackles, chains, bolts and so on. A *chime of opening* also automatically dispels a *hold portal* spell or even a *wizard lock* cast by a magic-user or sorcerer of lower than 15th level. Each sounding only opens one form of locking, so if a chest is chained, padlocked, locked and *wizard locked*, it takes four uses of a *chime of opening* to get it open. A *silence* spell negates the power of the device. A chime can be used a total of ten times before it cracks and becomes useless.

Circlet of Blasting I: On command, this gold headband projects a beam of searing light (3d8 points of damage) once per day.

Circlet of Blasting II: On command, this elaborate gold headband projects a beam of searing light (6d8 points of damage) once per day.

Circlet of Persuasion: This silver headband grants you a +2 reaction bonus.

Cloak of Arachnida: This black garment, embroidered with a web pattern in silver thread, gives the wearer the ability to climb as if a *spider climb* spell had been placed upon her. In addition, the cloak grants her immunity to entrapment by *web* spells and natural webs. She can actually move across webs at half her normal speed. Once per day, the wearer of this cloak can cast *web*. She also gains a +1 bonus to save vs. spider poison.

Cloak of the Bat: Fashioned of black cloth, this cloak bestows a +3 bonus on hide in shadows checks. The wearer is also able to hang upside down from the ceiling, like a bat. By holding the edges of the garment, the wearer is able to *fly* per the spell. If he desires, the wearer can actually *polymorph* into an ordinary bat and fly accordingly. Flying, either with the cloak or in bat form, can be accomplished only in darkness (either under the night sky or in a lightless or near-lightless environment underground). Either of the flying powers is usable for up to 7 minutes at a time, but after a flight of any duration the cloak cannot bestow any flying power for a like period of time.

Cloak of Charisma: This lightweight and fashionable cloak has a highly decorative silver trim. When in a character's possession, it grants them a charisma of 20 (+5 modifier), 22 (+7 modifier) or 24 (+9 modifier).

Cloak of Displacement, Minor: This item appears to be a normal cloak, but when worn it distorts and warps light waves. This it grants a +1 bonus to Armor Class and +1 save vs. aimed spell effects for a total of 15 rounds per day, divided up as the wearer sees fit.

Cloak of Displacement, Major: As the *minor cloak of displacement* except that it grants a +2 bonus to Armor Class and +2 save vs. aimed spell effects for a total of 15 rounds per day, divided up as the wearer sees fit.

Cloak of Elvenkind: This cloak of gray cloth looks unimpressive. However, when worn with the hood drawn up around the head, it gives the wearer a +3 bonus on hide in shadows checks.

Cloak of Etherealness: This silvery-gray cloak seems to absorb light rather than be illuminated by it. On command, the cloak makes its wearer ethereal. The effect is dismissible. The cloak works for a total of up to 10 minutes per day. This duration need not be continuous.

Cloak of the Manta Ray: This cloak appears to be made of leather until the wearer enters salt water. At that time the *cloak of the manta ray* adheres to the individual, and he appears nearly identical to a manta ray. He gains a +3 AC bonus, the ability to breathe underwater, and a swim speed of 60' per round like a real manta ray.

Although the cloak does not enable the wearer to bite opponents as a manta ray does, it does have a tail-spine that can be used to strike at opponents behind the wearer, dealing 1d6 points of damage. This attack can be used in addition to any other attack the character has. The wearer can release his arms from the cloak without sacrificing underwater movement.

Cloak of Resistance: These garments offer magic protection in the form of a +1 to +5 bonus on all saves.

Crystal Ball: This is the most common form of scrying device, a crystal sphere about 6 inches in diameter. A character can use the device to see over virtually any distance or into other planes of existence, as with the spell scrying. Certain *crystal balls* have additional powers that can be used through the *crystal ball* on any subject being viewed.

Crystal Ball Type	Value
Crystal ball	42,000 gp
Crystal ball with <i>detect invisibility</i>	50,000 gp
Crystal ball with <i>ESP</i>	51,000 gp
Crystal ball with <i>telepathy</i> *	70,000 gp
Crystal ball with <i>true seeing</i>	80,000 gp

*The viewer is able to send and receive silent mental messages with the person appearing in the crystal ball. Once per day the character may attempt to implant a suggestion as well.

Cube of Force: This device is $\frac{3}{4}$ " across and can be made of ivory, bone, or any hard mineral. It enables its possessor to put up a *wall of force* 10' on a side around her. This cubic screen moves with the character and is impervious to the attack forms mentioned on the table below. The cube has 36 charges, which are renewed each day. The possessor presses one face of the cube to activate a particular type of screen or to deactivate the device. Each effect costs a certain number of charges to maintain for every minute (or portion of a minute) in operation. Also, when an effect is active, the possessor's speed is limited to the maximum value given on the table.

When the *cube of force* is active, attacks dealing more than 30 points of damage drain 1 charge for every 10 points of damage beyond 30 that they deal. Spells that

affect the integrity of the screen also drain extra charges. These spells cannot be cast into or out of the cube:

Face	Charges/ Minute	Movement Rate	Effect
1	1	30'	Keeps out gases, wind, etc.
2	2	20'	Keeps out nonliving matter
3	3	15'	Keeps out living matter
4	4	10'	Keeps out magic
5	6	10'	Keeps out all things
6	0	As normal	Deactivates

Attack Form	Extra Charges
<i>Horn of blasting</i>	6
<i>Wall of fire</i>	2
<i>Passwall</i>	3
<i>Disintegrate</i>	6
<i>Phase door</i>	5
<i>Prismatic spray</i>	7

Cube of Frost Resistance: This cube is activated or deactivated by pressing one side. When activated, it creates a cube-shaped area 10' on a side centered on the cube. The temperature within this area is always at least 65°F. The field absorbs all cold attacks. If the field is subjected to more than 50 points of cold damage in 1 round, it collapses into its portable form and cannot be reactivated for 1 hour. If it absorbs more than 100 points of cold damage in a 10-round period, it is destroyed.

Cubic Gate: This item is fashioned from carnelian. Each of the six sides of the cube is keyed to a plane, one of which is the Material Plane. The character creating the item should choose the planes to which the other five sides are keyed. If a side of the cubic gate is pressed once, it opens a *gate* to a random point on the plane keyed to that side. There is a 10% chance per minute that an inhabitant of that plane comes through it looking for food, fun, or trouble. Pressing the side a second time closes the gate. It is impossible to open more than one gate at a time.

If a side is pressed twice in quick succession, the character so doing is transported to a random point on the other plane, along with all creatures within 10'. The other creatures may avoid this fate by passing a saving throw.

Decanter of Endless Water: If the stopper is removed from this ordinary-looking flask and a command word spoken, an amount of fresh or salt water pours out. Separate command words determine the type as well as the volume and velocity.

- "Stream" pours out 1 gallon per round

- "Fountain" produces a 5'-long stream at 5 gallons/round
- "Geyser" produces a 20'-long stream at 30 gallons/round

The geyser effect causes considerable back pressure, requiring the holder have a strength of 13 or more to avoid being knocked down. The force of the geyser deals 1d4 points of damage but can only affect one target per round. The command word must be spoken to stop it.

Deck of Illusions: This set of parchment cards is found in an ivory, leather, or wooden box. A full deck consists of thirty-four cards. When a card is drawn at random and thrown to the ground, a *spectral force* of a creature is formed. The figment lasts until dispelled. The illusory creature cannot move more than 30' away from where the card landed, but otherwise moves and acts as if it were real. At all times it obeys the desires of the character that drew the card. When the illusion is dispelled, the card becomes blank and cannot be used again. If the card is picked up, the illusion is dispelled. The cards in a deck and the illusions they bring forth are summarized on the following table.

Playing Card	Creature
Ace of hearts	Red dragon
King of hearts	Male human fighter and four guards
Queen of hearts	Female human wizard
Jack of hearts	Male human druid
Ten of hearts	Cloud giant
Nine of hearts	Ettin
Eight of hearts	Bugbear
Two of hearts	Goblin
Ace of diamonds	Glabrezu (demon)
King of diamonds	Male elf wizard and female apprentice
Queen of diamonds	Half-elf ranger (female)
Jack of diamonds	Harpy
Ten of diamonds	Male half-orc barbarian
Nine of diamonds	Ogre mage
Eight of diamonds	Gnoll
Two of diamonds	Kobold
Ace of spades	Lich
King of spades	Three male human clerics
Queen of spades	Medusa
Jack of spades	Male dwarf paladin
Ten of spades	Frost giant
Nine of spades	Troll
Eight of spades	Hobgoblin
Two of spades	Goblin
Ace of clubs	Iron golem
King of clubs	Three male halfling thieves
Queen of clubs	Pixies
Jack of clubs	Female half-elf bard
Ten of clubs	Hill giant

Nine of clubs	Ogre
Eight of clubs	Orc
Two of clubs	Kobold
Playing Card	Creature
Joker	Illusion of deck's owner
Joker	Illusion of deck's owner (sex reversed)

Dimensional Shackles: These shackles have gold runes traced across their iron surface. Any creature bound within them is affected as if *dimensional anchor* were cast on her (no save). They fit any small to large creature.

Drums of Panic: These kettle drums come in pairs and are unremarkable in appearance. If the pair of drums is played, all creatures within 120' (except in a 20' radius safe zone around the drums) are affected as by a fear spell. *Drums of panic* can be used once per day.

Dust of Appearance: This fine powder appears to be a very fine, very light metallic dust. A single handful of this substance flung into the air coats objects within a 10' radius, making them visible even if they are invisible. It likewise negates the effects of *blur* and *displacement*. In this, it works just like the *faerie fire* spell. The dust also reveals illusions and *mirror images* for what they are. A creature coated with the dust cannot hide in shadows. The dust's effect lasts for 5 minutes. *Dust of appearance* is typically stored in small silk packets or bone tubes.

Dust of Disappearance: This dust looks like *dust of appearance* and is stored in the same manner. A creature or object touched by it becomes invisible (per *invisibility II*). Normal vision cannot see dusted creatures or objects, nor can they be detected by magical means, including *detect invisibility* or *invisibility purge*. *Dust of appearance*, however, does reveal people and objects made invisible by *dust of disappearance*. Other factors, such as sound and smell, allow possible detection. The *invisibility II* bestowed by the dust lasts for 2d6 rounds. The invisible creature does not know when the effect will end.

Dust of Dryness: This special dust has many uses. If it is thrown into water, a volume of as much as 100 gallons is instantly transformed to nothingness and the dust becomes a marble-sized pellet, floating or resting where it was thrown. If this pellet is hurled down, it breaks and releases the same volume of water. The dust only affects water (fresh, salt, alkaline).

If the dust is employed against a water elemental, the creature must make a saving throw or be destroyed. The dust deals 5d6 points of damage to the creature even if its saving throw succeeds.

Dust of Illusion: This powder resembles chalk dust or powdered graphite. Stare at it, however, and the dust changes color and form. Put *dust of illusion* on a creature, and that creature is affected as if by *change self*, with the individual who sprinkles the dust envisioning the illusion desired. An unwilling target is allowed a saving throw to avoid the dust. The illusion lasts for 2 hours.

Dust of Tracelessness: This dust is actually a magic powder that can conceal the passage of its possessor and his companions. Tossing a handful of this dust into the air causes a chamber of up to 100 square feet of floor space to become as dusty, dirty, and cobweb-laden as if it had been abandoned and disused for a decade.

A handful of dust sprinkled along a trail causes evidence of the passage of as many as a dozen men and horses to be obliterated for 250' back into the distance. The results of the dust are instantaneous, and no magical aura lingers afterward from this use of the dust.

Efficient Quiver: This quiver has three distinct portions, each with a non-dimensional space allowing it to store far more than would normally be possible. The first and smallest one can contain up to 60 objects of the same general size and shape as an arrow. The second slightly longer compartment holds up to 18 objects of the same general size and shape as a javelin. The third and longest portion of the case contains as many as six objects of the same general size and shape as a bow (spears, staffs or the like). Once the owner has filled it, the quiver can produce any item she wishes, as if from a regular quiver or scabbard. The efficient quiver weighs the same no matter what's placed inside it.

Efreeti Bottle: This item is typically fashioned of brass or bronze, with a lead stopper bearing special seals. A thin stream of smoke is often seen issuing from it. The bottle can be opened once per day. When opened, the efreeti imprisoned within billows from the bottle instantly. There is a 10% chance that the efreeti is insane and attacks immediately upon being released. There is also a 10% chance that the efreeti of the bottle grants three wishes. In either case, the efreeti afterward disappears forever. The other 80% of the time, the inhabitant of the bottle loyally serves the character for up to 10 minutes per day (or until the efreeti's death), doing as she commands. Roll each day the bottle is opened for that day's effect.

Elemental Gem: This gem contains a conjuration spell attuned to a specific Elemental Plane. When the gem is crushed, smashed, or broken, a large elemental appears.

The elemental is under the control of the creature that broke the gem. The coloration of the gem varies with the type of elemental it summons. Air gems are transparent, earth gems are light brown, fire gems are reddish orange and water gems are blue-green. The elemental returns to its home plane after one minute.

Elixir of Fire Breath: This strange elixir bestows upon the drinker the ability to spit gouts of flame. He can breathe fire up to three times, each time dealing 4d6 points of fire damage to a single target up to 25' away. The victim can attempt a saving throw for half damage. Unused blasts dissipate 1 hour after consumed.

Elixir of Hiding: A character drinking this liquid gains a +5 bonus on hide in shadows checks for 1 hour.

Elixir of Love: This sweet-tasting liquid causes the character drinking it to become charmed with the first creature she sees after consuming the draft. The charm effects wear off in 1d4 hours.

Elixir of Sneaking: This draught of liquid grants the drinker the ability to walk softly and dampens sound around her, granting a +5 bonus on move silently checks for 1 hour.

Elixir of Swimming: This elixir bestows swimming ability. An almost imperceptible magic sheath surrounds the drinker, allowing him to glide through the water easily at a speed of 50' per round.

Elixir of Truth: This elixir forces the drinker to speak nothing but the truth for 10 minutes (save negates).

Elixir of Vision: Drinking this elixir grants the imbiber a 4 in 6 chance to find secret doors for 1 hour.

Eversmoking Bottle: This metal urn looks like an *efreeti bottle* except that it does nothing but smoke. The amount of smoke is large if the stopper is pulled out, pouring from the bottle and totally obscuring vision across a 50' spread in 1 round. If the bottle is left un-stoppered, the smoke billows out another 10' per round until it has covered a 100' radius. This area remains smoke-filled until the bottle is stoppered. It must be resealed by a command word, after which the smoke dissipates.

Eyes of Charming: These two crystal lenses fit over the user's eyes. The wearer is able to use *charm person* merely by meeting a target's gaze.

Eyes of Doom: These crystal lenses fit over the user's eyes, enabling him to cast *doom* upon those around him (one target per round) as a gaze attack. The wearer also

gains the power of a continual *deathwatch* effect and can use *fear* as a normal gaze attack once per week.

Eyes of the Eagle: These items are made of special crystal and fit over the eyes of the wearer. These lenses grant a 3 in 6 chance to find secret doors and they can see 10 times as far as a normal human.

Eyes of Petrification: These items are made of special crystal and fit over the eyes of the wearer. They allow her to use a petrification gaze attack as a medusa for up to 10 rounds per day. Both lenses must be worn for the magic to be effective.

Figurines of Wondrous Power: Each of the several kinds of *figurines of wondrous power* appears to be a statuette an inch or so high (with one exception). When the figurine is tossed down and the correct command word spoken, it becomes a living creature of normal size (except when noted otherwise below). The creature obeys and serves its owner. Unless noted otherwise, the creature understands common but does not speak.

If a figurine is broken or destroyed in its statuette form, it is forever ruined. All magic is lost, its power departed. If slain in animal form, the figurine reverts to a statuette that can be used again at a later time.

Bronze Griffon: When animated, a bronze griffon acts in all ways like a normal griffon under the command of its possessor. The item can be used twice per week for up to 6 hours per use. When 6 hours have passed or when the command word is spoken, the bronze griffon once again becomes a tiny statuette.

Ebony Fly: When animated, an ebony fly is the size of a pony and has all the statistics of a hippogriff but can make no attacks. The item can be used three times per week for up to 12 hours per use. When 12 hours have passed or when the command word is spoken, the ebony fly again becomes a tiny statuette.

Golden Lions: These figurines come in pairs. They become normal adult male lions. If slain in combat, the lions cannot be brought back from statuette form for one full week. Otherwise, they can be used once per day for up to 1 hour.

Ivory Goats: These figurines come in threes. Each goat of this trio looks slightly different from the others, and each has a different function:

- The Goat of Traveling provides a speedy and enduring mount equal to that of a heavy horse in every way except appearance. The goat can travel for a maximum of one

day each week, continuously or in any combination of periods totaling 24 hours. At this point, or when the command word is uttered, it returns to its statuette form for not less than one day before it can again be used.

- The Goat of Travail becomes an enormous creature, larger than a bull, with the statistics of a nightmare except for the addition of a pair of wicked horns (damage 1d8 for each horn). If it is charging to attack, it may only use its horns. It can be called to life just once per month for up to 12 hours at a time.
- The Goat of Terror becomes a destrier-like mount, with the statistics of a light warhorse. However, its rider can employ the goat's horns as weapons (one horn as a +3 *heavy lance*, the other as a +5 *longsword*). When ridden in an attack against an opponent, the goat of terror radiates fear as the spell in a 30-foot radius. It can be used once every two weeks for up to 3 hours per use.

Marble Elephant: This is the largest of the figurines, the statuette being about the size of a human hand. Upon utterance of the command word, a marble elephant grows to the size and specifications of a true elephant. The animal created from the statuette is fully obedient to the figurine's owner, serving as a beast of burden, a mount, or a combatant. The statuette can be used four times per month for up to 24 hours at a time.

Obsidian Steed: This figurine appears to be a small, shapeless lump of black stone. Only careful inspection reveals that it vaguely resembles some form of quadruped. On command, the near-formless piece of obsidian becomes a fantastic mount. Treat it as a heavy warhorse with the following additional powers usable once per round at will: *Overland flight*, *plane shift* and *ethereal jaunt*. The steed allows itself to be ridden, but if the rider is of Lawful alignment, the steed is 10% likely per use to carry him to the lower planes and then return to its statuette form. The statuette can be used once per week for one continuous period of up to 24 hours. Note that when an obsidian steed becomes ethereal or plane shifts, its rider and his gear follow suit.

Onyx Dog: When commanded, this statuette changes into a creature with the same properties as a dog except that it is endowed with low intelligence, can communicate in common and has exceptional olfactory and visual abilities. It has 60-foot darkvision, and it can *detect invisibility*. An onyx dog can be used once per week for up to 6 hours.

Serpentine Owl: This figurine becomes either a normal-sized horned owl or a giant owl according to the

command word used. The transformation can take place once per day, with a maximum duration of 8 continuous hours. However, after three transformations into giant owl form, the statuette loses all its magical properties. The owl communicates with its owner by telepathic means, informing her of all it sees and hears.

Silver Raven: This silver figurine turns into a raven on command (but it retains its metallic consistency, which gives it AC 20). Another command sends it off into the air, bearing a message just like a creature affected by an *animal messenger* spell. If not commanded to carry a message, the raven obeys the commands of its owner, although it has no special powers or telepathic abilities. It can maintain its non-figurine status for only 24 hours per week, but the duration need not be continuous.

Feather Token: Each of these items is a small feather that has a special power. The kinds of tokens are described below. Each token is usable only one time.

Anchor: A token useful to moor a craft in water so as to render it immobile for up to one day.

Bird: A token that can be used to deliver a small written message unerringly to a designated target as would a carrier pigeon. The token lasts as long as it takes to carry the message.

Fan: A token that forms a huge flapping fan, causing a breeze of sufficient strength to propel one ship at about 12 mph (a little more than 100' per round). This wind does not add to existing wind speed. The token can, however, be used to lessen existing winds, creating an area of relative calm or lighter winds, but wave size in a storm is not affected. The fan can be used for up to 8 hours. It does not function on land.

Swan Boat: A token that forms a swan-like boat capable of moving on water at a movement rate of 60'. It can carry eight horses and gear or thirty-two characters or any equivalent combination. The boat lasts for one day.

Tree: A token that causes a great oak to instantaneously spring into being (5' diameter trunk, 60' height, 40' top diameter).

Whip: A token that forms into a huge leather whip and wields itself against any opponent desired just like a *dancing sword*. The weapon has a +10 attack bonus, does 1d6 points of damage, has a +1 magic bonus on attack and damage rolls and makes a free grapple attack if it hits. The whip lasts no longer than 1 hour.

Gauntlets of Ogre Power: These gauntlets are made of tough leather with iron studs running across the back of the hands and fingers. They grant the wearer a strength of 19 (a +4 bonus). Both must be worn to work.

Gauntlet of Rust: This single metal gauntlet looks rusted and pitted but is actually quite powerful. Once per day, it can affect an object as with the *rusting grasp* spell. It also completely protects the wearer and her gear from rust, magical or otherwise.

Gem of Brightness: This crystal appears to be a long, rough prism. Upon utterance of a command word, the crystal emits bright light of one of three sorts.

- One command word causes the gem to shed light as a hooded lantern. This use does not expend any charges.
- Another command word causes the gem to send out a bright ray 1 foot in diameter and 50' long. This strikes as a ranged attack, and any creature struck by this beam is blinded for 1d4 rounds unless it makes a saving throw. This use of the gem expends 1 charge.
- The third command word causes the gem to flare in a blinding flash of light that fills a 30' cone. Although this glare lasts but a moment, any creature within the cone must make a saving throw or be blinded for 1d4 rounds. This use expends 5 charges.

A newly created *gem of brightness* has 10 charges. When all its charges are expended, it becomes non-magical.

Gem of Seeing: This finely cut and polished stone is indistinguishable from an ordinary jewel in appearance. When it is gazed through, a *gem of seeing* enables the user to see as though she were affected by the *true seeing* spell. A *gem of seeing* can be used for as much as 30 minutes a day, divided up as the user sees fit.

Gloves of Arrow Snaring: Once snugly worn, these gloves seem to meld with the hands, becoming almost invisible. Twice per day, the wearer can deflect missiles as a monk. Both must be worn for the magic to work.

Gloves of Dexterity: These flexible leather gloves allow for delicate manipulation. They grant a dexterity of 20 (+5 modifier), 22 (+7 modifier) or 24 (+9 modifier). Both gloves must be worn for the magic to be effective.

Glove of Storing: On command, one item held in the hand wearing this glove disappears. The item can weigh no more than 20 pounds and must be able to be held in one hand. While stored, the item has negligible weight. With a snap of the fingers wearing the glove, the item

reappears. A glove can only store one item at a time. The item is held in stasis and shrunk down so small within the palm of the glove that it cannot be seen.

Gloves of Swimming and Climbing: These apparently normal lightweight gloves allow a character to swim at a rate of 50' and to climb at a rate of 20' with only a 1 in 6 chance of falling while climbing a sheer surface.

Golem Manual: A golem manual contains information, incantations and magical power that allow a character to craft a golem. Each manual covers the construction of a single type of golem, chosen by the TK.

Hand of Glory: This mummified human hand hangs by a leather cord around a character's neck. If a magic ring is placed on one of the fingers of the hand, the wearer benefits from the ring as if wearing it herself and it does not count against her two-ring limit. The hand can wear only one ring at a time. Even without a ring, the hand itself allows its wearer to use *daylight* and *detect invisibility* each once per day.

Hand of the Mage: This mummified elf hand hangs by a golden chain around a character's neck. It allows the wearer to use *mage hand* at will.

Handy Haversack: A backpack of this sort appears to be quite ordinary. It has two side pouches, each of which appears large enough to hold about a quart of material. In fact, each is like a *bag of holding* and can actually hold material of as much as 2 cubic feet in volume or 20 lb. in weight. The large central portion of the pack can contain up to 8 cubic feet or 80 lb. of material. Even when so filled, the backpack always weighs only 5 lb. While such storage is useful enough, the pack has an even greater power; when the wearer reaches into it for a specific item, that item is always on top.

Harp of Charming: This instrument is a golden, intricately carved harp. When played, it enables the performer to work one *suggestion* into his music for each 10 minutes of playing. The harp affects all who hear it, or a specific target designated by the harpist.

Hat of Conjuring: This conical wizard's hat is capable of casting *shadow conjuration I* three times per day, and *shadow conjuration II* once per day when its owner reaches into the hat while speaking a short rhyme to tell it what they want. The hat's user must roll 1d20 under intelligence score or the hat misinterprets their rhyme in some way (TK's discretion).

Hat of Disguise: This hat allows its wearer to alter her appearance as with *change self*. As part of the disguise, the hat can be changed to appear as a comb, ribbon, headband, cap, coif, hood, helmet, and so on.

Headband of Intellect: This device is a light cord with a small gem set so that it rests upon the forehead of the wearer. The headband grants the wearer an intelligence score of 20, 22 (+7 modifier) or 24 (+9 modifier).

Helm of Brilliance: This normal-looking helm takes its true form and manifests its powers when the user dons it and speaks the command word. Made of brilliant silver and polished steel, a newly created helm is set with large magic gems: Ten diamonds, twenty rubies, thirty fire opals, and forty opals. When struck by bright light, the helm scintillates and sends forth reflective rays in all directions from its crown-like, gem-tipped spikes. The jewels' functions are as follows:

- Diamond: *Prismatic spray*
- Ruby: *Wall of fire*
- Fire opal: *Fireball* (10d6)
- Opal: *Daylight*

The helm may be used once per round, but each gem can perform its spell-like power just once. Until all its jewels are depleted, a helm of brilliance also has the following magical properties when activated.

- It emanates a bluish light when undead are within 30'. This light causes 1d6 points of damage per round to all such creatures in range.
- The wearer may command any weapon he wields to become a flaming weapon (+1d6 fire damage).
- The helm provides resistance to fire.

Once all its jewels have lost their magic, the helm loses its powers and the gems turn to worthless powder. Removing a jewel destroys it.

If a creature wearing the helm is damaged by magical fire (after the fire protection is taken into account) and fails an additional saving throw, the remaining gems on the helm overload and detonate. Remaining diamonds become *prismatic sprays* that each randomly target a creature within range (possibly the wearer), rubies become straight-line *walls of fire* extending outward in a random direction from the helm wearer, and fire opals become *fireballs* centered on the helm wearer. The opals and the helm itself are destroyed.

Helm of Comprehend Languages: Appearing as a normal helmet, a *helm of comprehend languages* grants its wearer the ability to understand the spoken words of any creature and to read text in any language and any magical writing.

Helm of Telepathy: The wearer can use *ESP* at will. Furthermore, he can send a telepathic message to anyone whose surface thoughts he is reading (allowing two-way communication). Once per day, the wearer can implant a *suggestion* along with his message.

Helm of Teleportation: A character wearing this device may *teleport* three times per day.

Helm of Underwater Action: The wearer of this helmet can see clearly underwater. Drawing the small lenses in compartments on either side into position before the wearer's eyes activates the visual properties of the helm, allowing her to see five times farther than water and light conditions would allow for normal human vision. Weeds, obstructions, and the like block vision in the usual manner. If the command word is spoken, the helm of underwater action creates a globe of air around the wearer's head and maintains it until the command word is spoken again, enabling her to breathe freely.

Horn of Blasting: This horn appears to be a normal trumpet. It can be sounded as a normal horn, but if the command word is spoken and the instrument is then played, it deals 5d6 points of sonic damage to creatures within a 40' cone and causes them to be deafened for 2d6 rounds. A save reduces the damage by half and negates the deafening. Crystalline objects and creatures take 7d6 points of sonic damage, with no save unless they're held, worn, or carried by creatures.

If a *horn of blasting* is used magically more than once in a given day, there is a 20% cumulative chance with each extra use that it explodes and deals 10d6 points of damage to the person sounding it.

Horn of Blasting, Greater: This horn functions as a *horn of blasting*, except that it deals 10d6 points of sonic damage, stuns creatures for 1 round, and deafens them for 4d6 rounds. Crystalline objects take 16d6 points of sonic damage as described for the *horn of blasting*. A *greater horn of blasting* also has a 20% cumulative chance of exploding.

Horn of Fog: This small bugle allows its possessor to blow forth a thick cloud of heavy fog similar to that of an *obscuring mist* spell. The fog covers a 10 square foot area next to the horn blower each round that the user

continues to blow the horn; fog clouds travel 10' each round in a straight line from the emanation point unless blocked by something substantial such as a wall. The device makes a deep, foghorn-like noise, with the note dropping abruptly to a lower register at the end of each blast. The fog dissipates after 3 minutes.

Horn of Goodness/Evil: This trumpet adapts itself to its owner, so it produces either a good or an evil effect depending on the owner's alignment. If the owner is neither Lawful nor Chaotic, the horn has no power whatsoever. If he is Lawful, then blowing the horn has the effect of a *protection from evil II*. If he is Chaotic, then blowing the horn has the effect of a *protection from good II*. In either case, this ward lasts for 1 hour. The horn can be blown once per day.

Horn of the Tritons: This device is a conch shell that can be blown once per day (except by a triton which can sound it three times per day). A *horn of the tritons* can perform any one of the following functions when blown.

- Calm rough waters in a 1-mile radius. This effect dispels a summoned water elemental if it fails a save.
- Attract 5d4 large sharks (01–30 on d%), 5d6 medium sharks (31–80), or 1d10 sea cats (81–100) if the character is in a body of water in which such creatures dwell. The creatures are friendly and obey, to the best of their ability, the one who sounded the horn.
- Causes aquatic creatures of animal intelligence within 500' to become frightened.

Any sounding of a horn of the tritons can be heard by all tritons within a 3-mile radius.

Horn of Valhalla: This horn comes in four varieties. Each appears normal until someone speaks its command word and blows the horn. Then, the horn summons a number of berserkers to fight for the character who summoned them. Each horn can be blown once every seven days. Roll d% to see what type of horn is found.

d%	Type of Horn	Berserkers Summoned
01–40	Silver	2d6
41–75	Brass	3d6
76–90	Bronze	4d6
91–00	Iron	5d6

Horseshoes of Speed: These iron shoes come in sets of four. When affixed to an animal's hooves, they increase

the animal's land speed by 30' per round. All four must be worn by the same animal to work.

Horseshoes of a Zephyr: These four iron shoes are affixed like normal horseshoes. They allow a horse to travel without actually touching the ground. The horse must still run above (always around 4 inches above) a roughly horizontal surface. This means that non-solid or unstable surfaces can be crossed and that movement is possible without leaving tracks on any sort of ground. The horse moves at its normal land speed. All four must be worn by the same animal to work.

Incense of Meditation: This small rectangular block of sweet smelling incense is indistinguishable from non-magical incense until lit. When it is burning, the special fragrance and pearly-hued smoke of this special incense are recognizable by any spell caster. When a divine spell caster lights a block of *incense of meditation* and then spends 8 hours praying and meditating nearby, the incense enables him to prepare all his spells so that when cast all variables of those spells are maximized.

Instant Fortress: This metal cube is small, but when activated by a command word it grows to form a tower 20' square and 30' high, with arrow slits on all sides and a crenellated battlement atop it. The metal walls extend 10' into the ground, rooting it to the spot and preventing it from being tipped over. The fortress has a small door that opens only at the command of the owner of the fortress, even *knock* can't open it.

The adamantine walls of *instant fortress* have 100 hit points and an AC of 30. The fortress cannot be repaired except by *wish* or *miracle*, which restores 50 hit points. The fortress springs up in just 1 round, with the door facing the device's owner. The door opens and closes instantly at his command. People and creatures nearby (except the owner) must be careful not to be caught by the fortress's sudden growth. Anyone so caught takes 10d10 points of damage (save for half damage). The fortress is deactivated by speaking a command word (different from the one used to activate it). It cannot be deactivated unless it is empty.

Ioun Stones: These crystalline stones plucked from far dimensions always float in the air and must be within 3' of their owner to be of any use. When a character first acquires a stone, she must hold it and then release it, whereupon it takes up an orbit 1d3 feet from her head. Thereafter, a stone must be grasped or netted to separate it from its owner. The owner may voluntarily seize and stow a stone (to keep it safe while she is

sleeping, for example), but she loses the benefits of the stone during that time. *Ioun stones* have AC 24 and 10 hp.

Type	Effect	Value
Clear spindle	Sustains creature without food or water	4,000 gp
Dusty rose prism	+1 bonus to Armor Class	5,000 gp
Deep red sphere	+1 to ranged attacks	8,000 gp
Incandescent blue sphere	+1 bonus to save vs. magic	8,000 gp
Pale blue rhomboid	+1 to melee damage	8,000 gp
Pink rhomboid	+1 hit point per level or HD	8,000 gp
Pink and green sphere	+1 reaction bonus	8,000 gp
Scarlet and blue sphere	+1 bonus to find secret doors and traps	8,000 gp
Dark blue rhomboid	Only surprised on 1 on 1d6	10,000 gp
Vibrant purple prism	Stores three levels of spells	36,000 gp
Iridescent spindle	Sustains creature without air	18,000 gp
Pale lavender ellipsoid	Absorbs spells of 4th level or lower*	20,000 gp
Pearly white spindle	Regenerate 1 hp per hour	20,000 gp
Pale green prism	+1 on attacks and saves	30,000 gp
Orange prism	+1 caster level	30,000 gp
Lavender and green ellipsoid	Absorbs spells of 8th level or lower**	40,000 gp

*After absorbing 20 spell levels, the stone turns to dull gray and is forever useless

**After absorbing 50 spell levels, the stone turns to dull gray and is forever useless

The *pearly white ioun stone* works like the *ring of regeneration*. The *pale lavender* and *lavender and green* stones work like a *rod of absorption*. Stored spells in the *vibrant purple stone* must be placed there by a spellcaster but can be used by anyone.

Iron Bands of Binding: When initially discovered, this very potent item appears to be a 3" diameter rusty iron sphere circled by bands. When the command word is spoken and the device is hurled at an opponent, the bands expand to bind the target creature on a successful ranged attack. A single creature up to large size can be captured and held immobile until the command word is spoken to bring the bands into spherical form again. *Iron bands of binding* are usable once per day.

Iron Flask: These special containers are inlaid with silver runes and stoppered by a brass plug engraved with special symbols. When the user speaks the command

word, he can force any creature from another plane into the container, provided that creature fails a save. The range of this effect is 60'. Only one creature at a time can be contained. Removing the stopper frees the captured creature. The command word can be said once per day.

If the individual freeing the captured creature speaks the command word, the creature must serve her for 1 hour. If freed without the command word, the creature does as it pleases. Any attempt to force the same creature into the flask a second time provides it a +2 bonus on its saving throw and makes it hostile. A newly discovered bottle might contain any of the following:

d%	Contents	d%	Contents
01-50	Empty	89	Demon – glabrezu
51-54	Large air elemental	90	Demon – succubus
55-58	Arrowhawk	91	Devil, bone
59-62	Large earth elemental	92	Devil, barbed
63-66	Xorn	93	Devil – erinyes
67-70	Large fire elemental	94	Devil, horned
71-74	Greater salamander	95	Celestial – avoral
75-78	Large water elemental	96	Celestial – ghaele
79-82	Tojanida	97	Formian myrmarch
83-85	Chaos beast	98	Rakshasa
86-87	Demon – vroock	99	Demon – balor
88	Demon – hezrou	00	Devil – pit fiend

Lantern of Revealing: This lantern operates as a normal hooded lantern. While it is lit, it also reveals all invisible creatures and objects within 25' of it.

Lens of Detection: This circular prism enables its user to detect minute details, granting a 3 in 6 chance to find secret door and a +3 bonus on tracking checks. The lens is 6 inches in diameter and set in a frame with a handle.

Lenses of Minute Seeing: The lenses of this item are made of special crystal. When placed over the eyes of the wearer, the lenses enable her to see much better than normal at distances of 1 foot or less, granting her a +3 bonus to find secret doors, traps, and similar concealed objects. Both must be worn for to work.

Lenses of Night: The lenses of this item are made of dark crystal. Even though the lenses are opaque, when placed over the eyes of the wearer they enable him to see normally and also grant him 60' darkvision. Both must be worn to work.

Lyre of Building: If the proper chords are struck, a single use of this lyre negates any attacks made against

all buildings within 300'. This includes the effects of a *horn of blasting*, a *disintegrate* spell or an attack from a ram or similar siege weapon. The lyre can be used in this way once per day with the protection lasting 30 minutes.

The lyre is also useful with respect to building. Once a week its strings can be strummed so as to produce chords that magically construct buildings, mines, tunnels, ditches or whatever. The effect produced in 30 minutes of playing is equal to the work of 100 humans laboring for three days. Each hour after the first, a character playing the lyre must make a saving throw. If it fails, she must stop and cannot play the lyre again for this purpose until a week has passed.

Mantle of Faith: This holy garment, worn over normal clothing, grants the wearer resistance to non-magical weapons used by Chaotic creatures.

Mantle of Magic Resistance: This garment, which is worn over normal clothing or armor, grants the wearer magic resistance 35%.

Manual of Bodily Health: This thick tome contains tips on health and fitness, but entwined within the words is a powerful magical effect. If anyone reads this book, which takes 48 hours over a minimum of six days, he gains an inherent bonus of from +1 to +5 (depending on the type of manual) to his constitution score (max. 20). Once the book is read, it becomes a normal book.

Manual of Gainful Exercise: This thick tome contains exercise descriptions and diet suggestions, but entwined within the words is a powerful magical effect. If anyone reads this book, which takes 48 hours over a minimum of six days, she gains an inherent bonus of from +1 to +5 to her strength score (max. 20). Once the book is read, it becomes a normal book.

Manual of Quickness of Action: This thick tome contains tips on coordination exercises and balance, but entwined within the words is a powerful magical effect. If anyone reads this book, which takes 48 hours over a minimum of six days, he gains an inherent bonus of from +1 to +5 to his dexterity score (max. 20). Once the book is read, it becomes a normal book.

Marvelous Pigments: These magic emulsions enable their possessor to create real objects by depicting their form in two dimensions. The pigments are applied by a brush. The emulsion flows from the application to form the desired object as the artist concentrates on the desired image. One pot is sufficient to create a 1,000-cubic-foot object by depicting it two-dimensionally over

a 100-square-foot surface. Only mundane objects can be created. The pigments must be applied to a surface. It takes 10 minutes to depict an object with the pigments. *Marvelous pigments* cannot create magic items. Objects of value depicted by the pigments — precious metals, gems, jewelry, ivory, and so on — appear to be valuable but are really made of tin, lead, paste, brass, bone, and other such inexpensive materials. The user can create normal weapons, armor, and any other mundane item (including foodstuffs) whose value does not exceed 2,000 gp.

Mask of the Skull: This ivory mask has been fashioned into the likeness of a human skull. Once per day, after it has been worn for at least 1 hour, the mask can be loosed to fly from the wearer's face. It travels up to 50' away from the wearer and attacks a target assigned to it. The grinning skull mask makes a melee attack against the target based on the wearer's attack bonus. If the attack succeeds, the target must make a saving throw or be struck dead, as if affected by *finger of death*. Even if the target succeeds on his save, he still takes 3d8 points of damage. After attacking (successfully or not), the mask flies back to its user. The mask has AC 16 and 10 hp.

Mattock of the Titans: This digging tool is 10' long. Any creature of at least huge size can use it to loosen or tumble earth or earthen ramparts (a 10' cube every 10 minutes). It also smashes rock (a 10' cube per hour). If used as a weapon, it deals 4d6 damage.

Maul of the Titans: This mallet is 8' long. If used as a weapon, it deals 2d6 points of damage and deals triple damage against inanimate objects. The wielder must have a strength score of at least 18 to wield it properly. Otherwise, she takes a -4 penalty on attack rolls.

Medallion of ESP: This appears to be a normal pendant disk hung from a neck chain. Fashioned from bronze, copper, or nickel-silver, the medallion allows the wearer to read the thoughts of others.

Mirror of Life Trapping: This crystal device is 4' square. It can be hung or placed on a surface and then activated by giving a command word. The same command word deactivates the mirror. A *mirror of life trapping* has 15 non-spatial extra-dimensional cells within it. Any creature coming within 30' of the device and looking at its own reflection must make a saving throw or be trapped within the mirror in one of the cells. A creature not aware of the nature of the device always sees its own reflection. The probability of a creature seeing its reflection, and thus needing to make the saving throw, drops to 50% if the

creature is aware that the mirror traps life and seeks to avoid looking at it (treat as a gaze attack).

When a creature is trapped, it is taken bodily into the mirror. Size is not a factor, but constructs and undead cannot be trapped, nor can inanimate objects and other non-living matter. A victim's equipment remains behind. If the mirror's owner knows the right command word, he can call the reflection of any creature trapped within to its surface and engage his powerless prisoner in conversation. Another command word frees the trapped creature. Each pair of command words is specific to a particular prisoner.

If the mirror's capacity is exceeded, one random victim is set free in order to trap the latest one. If the mirror is broken, all victims are freed.

Mirror of Mental Prowess: This mirror resembles an ordinary looking glass 5' tall by 2' wide. The possessor who knows the command word can cause it to perform as follows.

- Read the thoughts of any creature reflected therein, as long as the owner is within 25' of the mirror.
- View other places as if with *clairsentience*, but vision extends even onto other planes if the viewer is sufficiently familiar with them.
- Use it as a portal to visit other places. The user first views the place with the *clairsentience* function, then steps through the mirror to the place pictured. Others can follow her through the mirror if they like. An invisible portal remains on the other side where she arrives, and she can return through that portal. Once she returns, the portal closes. The portal closes after 24 hours, and the user can also close it with a command word. Creatures with Intelligence of 12 or higher might notice the portal just as they might notice a magical sensor from a scrying spell. Any creature who steps through the portal appears in front of the mirror.
- Once per week the mirror accurately answers one short question regarding a creature shown on its surface.

Mirror of Opposition: This item resembles a normal mirror 4' long and 3' wide. It can be hung or placed on a surface and then activated (and deactivated) with a command word. If a creature sees its reflection in the mirror's surface, an exact duplicate of that creature comes into being. This opposite immediately attacks the original. The duplicate has all the possessions and powers of its original, including magic. Upon the defeat

or destruction of either the duplicate or original, the duplicate and her items disappear completely. The mirror functions four times per day.

Necklace of Adaptation: This necklace is a heavy chain with a platinum medallion. The magic of the necklace wraps the wearer in a shell of fresh air, making him immune to all harmful vapors and gases and allowing him to breathe, even underwater or in a vacuum.

Necklace of Fireballs: This device appears to be nothing but beads on a string, sometimes with the ends tied together to form a necklace. If a character holds it, all can see the strand as it really is, a golden chain from which hang a number of golden spheres. The spheres are detachable by the wearer (and only by the wearer), who can hurl one of them up to 70'. When a sphere arrives at the end of its trajectory, it detonates as a *fireball* spell.

Spheres come in different strengths. Each necklace of fireballs contains a combination of spheres of various strengths. Some traditional combinations, designated types I through VII, are detailed below.

Type	I	II	III	IV	V	VI	VII
2d6	-	2	-	4	-	-	-
3d6	2	-	4	-	2	-	2
4d6	-	2	-	2	-	4	-
5d6	1	-	2	-	2	-	2
6d6	-	1	-	2	-	2	-
7d6	-	-	1	-	2	-	2
8d6	-	-	-	1	-	2	-
9d6	-	-	-	-	1	-	2
10d6	-	-	-	-	-	1	1

If the necklace is being worn or carried by a character who fails her saving throw against a magical fire attack, the item must make a saving throw as well (with a save value of 9). If the necklace fails to save, all its remaining spheres detonate simultaneously.

Orb of Storms: This glass sphere is 8" in diameter. The possessor can call forth all manner of weather, even supernaturally destructive storms. Once per day she can use a *control weather* spell. Once per month, she can conjure a *storm of vengeance*. The possessor of the orb is continually protected by *endure elements*.

Pearl of Power: This seemingly normal pearl is a potent aid to all spell casters who prepare spells (i.e. not sorcerers). Once per day on command, a *pearl of power* enables the possessor to recall any one spell that she had

prepared and cast. The spell is then prepared again, just as if it had not been cast. The spell must be of a particular level, depending on the pearl. Different pearls exist for recalling one spell per day of each level from 1st through 9th and for the recall of two spells per day (each of a different level, 6th or lower).

Pearl of the Sirens: This normal-seeming pearl is beautiful and worth at least 1,000 gp on that basis alone. If it is clasped firmly in hand or held to the breast while the possessor attempts actions related to the pearl's powers, she understands and is able to employ the item. The pearl enables its possessor to breathe in water as if she were in clean, fresh air. Her swim movement rate is 60' and she can act underwater without hindrance.

Periapt of Health: The wearer of this blue gem on a silver chain is immune to disease, including supernatural diseases like mummy rot.

Periapt of Proof against Poison: This item is a brilliant-cut black gem on a delicate silver chain. The wearer is immune to poison, although poisons that are active when the periapt is first donned still run their course.

Periapt of Wisdom: Although it appears to be a normal pearl on a light chain, a *periapt of wisdom* grants the possessor's a wisdom score of 20 (+5 modifier), 22 (+7 modifier) or 24 (+9 modifier).

Periapt of Wound Closure: This stone is bright red and dangles on a gold chain. The periapt doubles the wearer's normal rate of healing or allows normal healing of wounds that would not do so normally. Hit point damage that involves bleeding is negated for the wearer of the periapt, but he is still susceptible to constitution damage caused by bleeding, such as that dealt by a stirge.

Phylactery of Faithfulness: This item is a small box containing religious scripture affixed to a leather cord and tied around the forehead. There is no mundane way to determine what function this religious item performs until it is worn. The wearer of a *phylactery of faithfulness* is aware of any action or item that could adversely affect his alignment and his standing with his deity, including magical effects. He acquires this information prior to performing such an action or becoming associated with such an item if he takes a moment to contemplate the act.

Phylactery of Undead Turning: This item is a boon to any character able to turn undead, allowing him to do so as if his class level were four levels higher.



Pipes of Haunting: This magic item appears to be a small set of pan pipes. When played, the pipes create an eerie, spellbinding tune. Those within 30' who hear the tune must succeed on a saving throw or be frightened for 4 rounds. Creatures with 6 or more Hit Dice are unaffected. They can be sounded twice a day.

Pipes of Pain: These appear to be like any other set of pipes with nothing to reveal their true nature. When played, the pipes create a wondrous melody. All within 30' must make a saving throw or be fascinated by the sound. As soon as the piping stops, all those affected are stricken by intense pain at even the slightest noise. Unless a character is in a totally silent area, she takes 1d4 points of damage per round for 2d4 rounds. During this time, damage from sonic attacks is doubled. Thereafter, the least noise causes an affected character to become stunned. This hypersensitivity is a curse and therefore hard to remove.

Pipes of the Sewers: These wooden pipes appear ordinary, but if the possessor learns the proper tune, he can attract 1d3 rat swarms if rats are within 400'. For each 50' distance the rats have to travel, there is a 1-

round delay. The piper must continue playing until the rats appear. If for any reason the piper ceases playing, the rats leave immediately. The rats obey the piper so long as he continues to play.

Pipes of Sounding: When played, these pipes create illusory sounds.

Portable Hole: A *portable hole* is a circle of cloth spun from the webs of a phase spider interwoven with strands of aether and moonbeams. When opened fully, a portable hole is 6' in diameter, but it can be folded up to be as small as a pocket handkerchief. When spread upon any surface, it causes an extra-dimensional space 10' deep to come into being. This hole can be picked up from inside or out by taking hold of the edges of the cloth and folding it up. Either way, the entrance disappears, but anything inside the hole remains.

The only air in the hole is that which enters when the hole is opened. It contains enough air to supply one creature for 10 minutes. The cloth does not accumulate weight even if its hole is filled. Each *portable hole* opens on its own particular non-dimensional space. If a *bag of holding* is placed within a *portable hole*, a rift to the Astral Plane is torn in that place. Both the bag and the hole are sucked into the void and forever lost. If a *portable hole* is placed within a *bag of holding*, it opens a gate to the Astral Plane. The hole, bag, and any creatures within a 10' radius are drawn there, with the hole and bag being destroyed in the process.

Restorative Ointment: A jar of this unguent is 3" in diameter, 1" deep and contains five applications. Placed on a poisoned wound or swallowed, it detoxifies any poison. Applied to a diseased area, it cures the disease. Rubbed on a wound, it cures 1d4+4 points of damage.

Ring Gates: These rings always come in pairs, two iron rings, each about 18 inches in diameter. The rings must be on the same plane of existence and within 100 miles of each other to function. Whatever is put through one ring comes out the other, and up to 100 pounds of material can be transferred each day. This useful device allows for instantaneous transport of items or messages and even attacks. A character can reach through to grab things near the other ring or even stab a weapon through if so desired. Alternatively, a character could stick his head through to look around. A spellcaster can cast a spell through a *ring gate*. Tiny creatures can pass through them. Each ring has an "entry side" and an "exit side," both marked with appropriate symbols.

Robe of the Archmagi: This garment can be white (01-45, Lawful), gray (46-75, Neutral), or black (76-00, Chaotic). Its wearer, if a caster of magic-user spells, gains the following powers: +3 AC, magic resistance 35% and a +2 bonus on all saving throws. If a white robe is donned by a Chaotic character she loses three levels. The reverse is true with respect to a black robe donned by a Lawful character. A Chaotic or Lawful character that puts on a gray robe, or a Neutral character that dons either a white or black robe, loses two levels.

Robe of Blending: When this robe is put on, the wearer intuitively knows that it has very special properties. A *robe of blending* enables its wearer to appear to be part of his surroundings. This allows him a +5 bonus to hide. The wearer can also adopt the appearance of another creature at will. All creatures friendly to the wearer see him normally.

Robe of Bones: This handy item functions much like a *robe of useful items* for a necromancer. It appears to be an unremarkable robe, but a character who dons it notes that it is adorned with small, embroidered figures representing undead creatures. Only the wearer of the robe can see the embroidery and recognize them for the creatures they become, and detach them. One figure can be detached each round. Detaching a figure causes it to become an actual undead creature. The skeleton or zombie is not under the control of the wearer of the robe, but may be subsequently commanded, rebuked, turned, or destroyed. A newly created robe of bones always has embroidered figures of three skeletons and two zombies.

Robe of Eyes: This valuable garment appears to be a normal robe until it is put on. Its wearer is able to see in all directions at the same moment due to scores of visible, magical eyelike patterns that adorn the robe. She also gains 120' darkvision. The *robe of eyes* sees all forms of invisible or ethereal things within 120'. The wearer of a *robe of eyes* gains a +5 bonus to find secret doors and she cannot be flanked. However, she is not able to avert her eyes or close her eyes when confronted by a creature with a gaze attack. *Light* or *continual light* cast directly on a *robe of eyes* causes it to be blinded for 1d3 minutes. A *daylight* spell blinds it for 2d4 minutes.

Robe of Scintillating Colors: The wearer of this robe can cause the garment to display a shifting pattern of hues, color after color cascading from the upper part of the robe to the hem in sparkling rainbows of dazzling light. The colors daze those near the wearer, conceal the wearer and illuminate the surroundings. It takes 1 round after the wearer speaks the command word for the

colors to start flowing on the robe. The colors create the equivalent of a gaze attack with a 30' range. Those who look at the wearer are dazed for 1d4+1 rounds. Every round of continuous scintillation gives the wearer better concealment. The attack penalty against the wearer starts at -2 and increases by -2 each round until it reaches -10. The robe illuminates a 30' radius. The effect can be used no more than a total of 10 rounds per day.

Robe of Stars: This garment is black or dark blue and embroidered with small white or silver stars. The robe enables its wearer to travel physically to the Astral Plane. It also gives its wearer a +1 bonus on all saving throws.

Robe of Useful Items: This appears to be an unremarkable robe, but a character who dons it notes that it is adorned with small cloth patches of various shapes. Only the wearer of the robe can see these patches, recognize them for what items they become, and detach them. One patch can be detached each round. Detaching a patch causes it to become an actual item. A newly created robe of useful items always has two each of the following patches: Dagger, bullseye lantern (filled and lit), mirror (highly polished 2' x 4' steel mirror), 10' pole, hempen rope (50' coil) and a large sack.

In addition, the robe has 4d4 additional patches:

d%	Result
01-08	Bag of 100 gold pieces
09-15	Silver coffer (6" x 6" x 1'), 500 gp value
16-22	Iron door up to 10' wide and 10' high and barred on one side—must be placed upright, attaches itself to wall
23-30	10 small gems
31-44	Ladder (24' long)
45-51	Mule with saddle bags
52-59	Open pit (10' x 10' x 10')
60-68	<i>Potion of extra healing</i>
69-75	Rowboat (12' long)
76-83	Scroll of one random 1st level spell
84-90	War dogs, pair (treat as wolves)
91-96	Window (2' x 4', up to 2' deep)
97-00	Portable ram

Multiple items of the same kind are permissible. Once removed, a patch cannot be replaced.

Rope of Climbing: A 60' long *rope of climbing* is no thicker than a wand, but it is strong enough to support 3,000 lb. Upon command, the rope snakes forward, upward, downward, or in any other direction at 10' per

round, attaching itself securely wherever its owner desires. It can also unfasten itself and return.

A *rope of climbing* can be commanded to knot or unknot itself. This causes large knots to appear at 1' intervals along the rope. Knotting shortens the rope to a 50' length until the knots are untied but grants a +6 bonus to climb while using it. A creature must hold one end of the rope when its magic is invoked.

Rope of Entanglement: A *rope of entanglement* looks just like any other hempen rope about 30' long. Upon command, the rope lashes forward 20' or upward 10' to entangle a victim. The rope has AC 22 and 20 hit points. The rope repairs damage to itself at a rate of 1 point per 5 minutes, but if a *rope of entanglement* is severed, it is destroyed.

Salve of Slipperiness: This substance provides a +12 bonus on all task checks involving escape and saving throws against grappling. In addition, obstructions such as webs (magical or otherwise) do not affect an anointed individual. Magic ropes and the like do not avail against this salve. If it is smeared on a floor or on steps, the area should be treated as a long-lasting *grease* spell.

The salve requires 8 hours to wear off normally, or it can be wiped off with an alcohol solution (even wine). *Salve of slipperiness* is needed to coat the inside of a container that is meant to hold *sovereign glue* (see below).

Scabbard of Keen Edges: This scabbard is fashioned from cured leather and fine silver. It can shrink or enlarge to accommodate any knife, dagger, sword, or similar weapon up to and including a greatsword. Up to three times per day on command, the scabbard casts keen edge on any blade placed within it.

Scarab of Protection: This item is a silver medallion in the shape of a beetle. If it is held for 1 round, an inscription appears on its surface letting the holder know that it is a protective device. The scarab's possessor gains magic resistance 45%. The scarab can also absorb level draining attacks, death effects and *inflict wounds* spells. Upon absorbing twelve such attacks, the scarab turns to powder and is destroyed.

Scarab, Golembane: This beetle-shaped pin enables its wearer to detect any golem within 60', although he must concentrate in order for the detection to take place. The scarab's wearer deals +1d6 damage to golems.

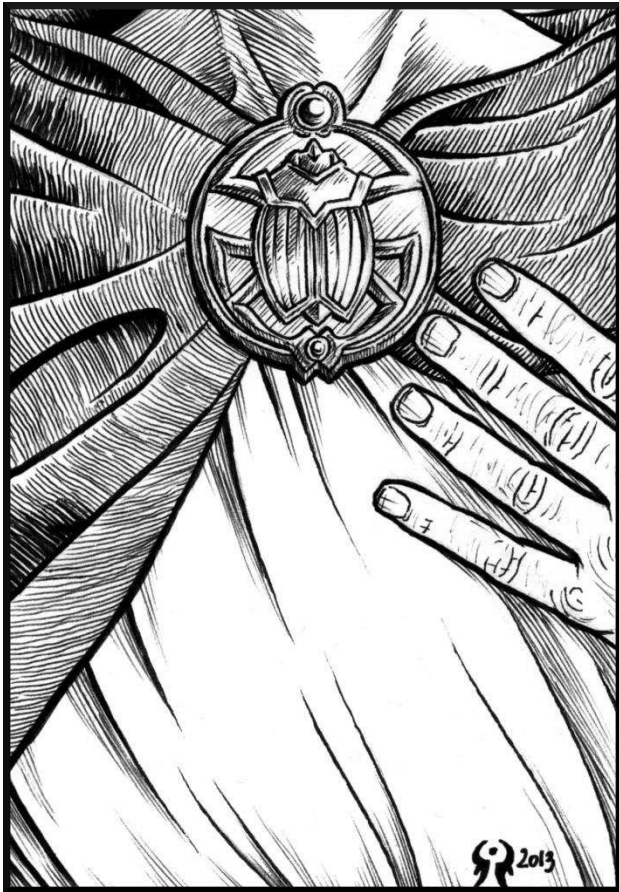

Silversheen: This substance can be applied to a weapon, giving it the properties of a silver weapon for 1 hour, and replacing the properties of any other special material it might have. One vial coats a single melee weapon or 20 units of ammunition.

Slippers of Spider Climbing: When worn, these slippers enable movement on vertical surfaces or upside down along ceilings. Her movement rate is 20'. Severely slippery surfaces make them useless. The slippers can be used for up to 10 minutes per day.

Sovereign Glue: This pale amber substance is thick and viscous. Because of its powers, it can be contained only in a flask whose inside has been coated with 1 ounce of *salve of slipperiness* and each time any of the bonding agent is poured from the flask a new application of the *salve of slipperiness* must be put in the flask to prevent the remaining glue from adhering to the container. A flask of *sovereign glue*, when found, holds 1d8 ounces. One ounce covers 1 square foot of surface and bonds virtually any two substances together permanently. The glue takes 1 round to set. If the objects are pulled apart before that time has elapsed, that application of the glue loses its stickiness and is worthless. If the glue is allowed

to set, then attempting to separate the two bonded objects has no effect except when *universal solvent* is applied. *Sovereign glue* is dissolved by *universal solvent*.

Stone of Alarm: This stone cube, when given the command word, affixes itself to any object. If that object is touched thereafter by anyone who does not first speak that command word, it emits a piercing screech for 1 hour that can be heard up to one quarter-mile away.

Stone of Controlling Earth Elementals: A stone of this type is typically an oddly shaped bit of polished rock. The possessor need but utter a few words of summoning, and a huge earth elemental appears. The summoning words require 1 round to speak, and in all ways the stone functions as *summon monster*. If sand or rough, natural stone is the summoning medium the elemental that comes is large instead. The elemental appears in 1d4 rounds. Only one elemental can be summoned at a time. A new elemental requires a new patch of earth or stone, which cannot be accessed until after the first disappears.

Stone of Good Luck (Luckstone): This stone is typically a bit of agate or some similar mineral. Its possessor gains a +1 bonus on saving throws.

Stone Horse: Each item of this nature appears to be a full sized, roughly hewn statue of a horse, carved from some type of hard stone. A command word brings the steed to life, enabling it to carry a burden and even to attack as if it were a real horse of the appropriate kind.

A stone horse can carry 1,000 lb. tirelessly and never needs to rest or feed. Damage dealt to it can be repaired by first using a *stone to flesh* spell, thus causing the stone horse to become a normal horse that can be healed normally. When fully healed, it automatically reverts to its stone form. While in its stone form, it can be fed gems, healing 1 hit point for each 50 gp worth of gem.

There are two sorts of stone horses.

Courser: As heavy horse with AC 20.

Destrier: As heavy warhorse with AC 20.

Stone Salve: This ointment has two uses. If applied to the flesh of a petrified creature, it returns the creature to flesh. If applied to the flesh of a non-petrified creature, it protects the creature per a *stoneskin* spell.

Strand of Prayer Beads: This item appears to be a normal string of prayer beads until the owner casts a divine spell. Once that occurs, the owner instantly knows the powers of the prayer beads and how to activate

them. Each strand includes two or more special beads, each with a different magic power.

Bead Type	Bead Ability
Blessing	Wearer can cast <i>bless</i>
Healing	Wearer can cast his choice of <i>cure serious wounds</i> , <i>cure blindness/deafness</i> or <i>cure disease</i>
Karma	Wearer casts spells at +4 caster level for 10 min.
Smiting	Wearer can cast <i>smite</i>
Summons	Summons a powerful creature of appropriate alignment from the Outer Planes (an angel, devil, etc.) to aid the wearer for one day. (If the wearer uses the bead of summons to summon a deity's emissary frivolously, the deity takes that character's items and places a <i>geas</i> upon him as punishment in the very least.)
Wind walking	Wearer can cast <i>wind walk</i>

A *lesser strand of prayer beads* has a bead of blessing and a bead of healing. A *strand of prayer beads* has a bead of healing, a bead of karma, and a bead of smiting. A *greater strand of prayer beads* has a bead of healing, a bead of karma, a bead of summons and a bead of wind walking.

Each special bead can be used once per day, except for the bead of summons, which works only once and then becomes non-magical. The power of a special bead is lost if it is removed from the strand.

Sustaining Spoon: This spoon is made of deer horn. If it is placed in an empty container the vessel fills with a thick, pasty gruel. Although this substance has a flavor similar to that of warm, wet cardboard, it is highly nourishing and contains everything necessary to sustain any herbivorous, omnivorous, or carnivorous creature. The spoon can produce sufficient gruel each day to feed up to four humans.

Tome of Clear Thought: This heavy book contains instruction on improving memory and logic, but entwined within the words is a powerful magical effect. If anyone reads this book, which takes a total of 48 hours over a minimum of six days, she gains an inherent bonus of from +1 to +5 (depending on the type of tome) to her intelligence score (max. 20). Once the book is read, the magic disappears from the pages and it becomes a normal book.

Tome of Leadership and Influence: This ponderous book details suggestions for persuading and inspiring others, but entwined within the words is a powerful magical effect. If anyone reads this book, which takes a total of 48 hours over a minimum of six days, he gains an

inherent bonus of from +1 to +5 (depending on the type of tome) to his charisma score (max. 20). Once the book is read, the magic disappears from the pages and it becomes a normal book.

Tome of Understanding: This thick book contains tips for improving instinct and perception, but entwined within the words is a powerful magical effect. If anyone reads this book, which takes a total of 48 hours over a minimum of six days, she gains an inherent bonus of from +1 to +5 (depending on the type of tome) to her wisdom score (max. 20). Once the book is read, the magic disappears from the pages.

Unguent of Timelessness: When applied to any matter that was once alive this ointment allows that substance to resist the passage of time. Each year of actual time affects the substance as if only a day had passed. The coated object gains a +1 bonus on all saving throws. The unguent never wears off, although it can be magically removed. One flask contains enough material to coat eight medium or smaller objects.

Universal Solvent: This substance has the unique property of being able to dissolve *sovereign glue*.

Vest of Escape: Hidden within secret pockets of this simple silk vest are lock picks that provide a +3 bonus on open lock checks. The vest also grants its wearer a +3 bonus on escape checks.

Vestment, Druid's: This light garment is worn over normal clothing or armor. Most are white and embroidered with druidic motifs. When worn by a druid, they can change shape one additional time each day.

Well of Many Worlds: This strange device looks just like a portable hole. Anything placed within it is immediately sent to another world; a parallel world, another planet, or a different plane (chosen randomly). If the well is moved, the random factor again comes into play. It can be picked up, folded, or rolled, just as a portable hole can be. Objects from the world the well touches can come through the opening just as easily as from the initiating place. (It is a two-way portal.)

Wind Fan: A wind fan appears to be nothing more than a wood and papyrus or cloth instrument with which to create a cooling breeze. By uttering the command word, its possessor causes the fan to generate air movement duplicating a *gust of wind* spell. The fan can be used once per day with no risk. If it is used more frequently, there is a 20% cumulative chance per usage during that day that the device tears into useless, non-magical tatters.

Wings of Flying: A pair of these wings might appear to be nothing more than a normal cloak, or they could be as elegant as a long cape of blue feathers. When the wearer speaks the command word, the cloak turns into a pair of bat or bird wings that empower her to fly at a rate of 60' per round.

Cursed Items

Cursed items are magic items with a negative impact. Sometimes they are directly bad for the user; sometimes they are just inconvenient. Occasionally they mix bad and good, forcing characters to make difficult choices. About 5% of found magic items are cursed.

d%	Curse
01-15	Delusion
16-35	Opposite effect or target
36-45	Intermittent functioning
46-60	Requirement
61-75	Drawback
76-90	Completely different effect
91-00	Substitute specific cursed item

Delusion: The user believes the item is what it appears to be, yet it actually has no magical power other than to deceive. The user is mentally fooled into thinking the item is functioning and cannot be convinced otherwise without the help of a *remove curse* spell.

Opposite Effect/Target: These items malfunction so that either they do the opposite of what the creator intended, or they target the user instead of someone else. The interesting point to keep in mind here is that these items are not always bad to have. Opposite-effect items include weapons that impose penalties on attack and damage rolls rather than bonuses. Just as a character should not necessarily immediately know what the magic bonus of a non-cursed magic item is, she should not immediately know that a weapon is cursed. Even if she knows, unfortunately, she is compelled to keep the item until a *remove curse* spell is cast upon her.

Intermittent Functioning: The three varieties of intermittent functioning items all function perfectly as described, at least some of the time. The three varieties are unreliable, dependent and uncontrolled items.

Unreliable: Each time the item is activated there is a 5% chance that it does not function.

Dependent: The item only functions in certain situations, determined by the TK.

Uncontrolled: An uncontrolled item occasionally activates at random times. There is a 5% chance each day that the item activates at a random point during that day.

Requirement: Some items have much more stringent requirements that must be met for them to be usable. To keep an item with this kind of curse functioning, one or more of the following conditions must be met.

- Character must eat twice as much as normal.
- Character must sleep twice as much as normal.
- Character must undergo a specific quest (one time only, and then item functions normally thereafter).
- Character must destroy 100 gp of valuables per day.
- Character must destroy 2,000 gp worth of magic items each week.
- Character must swear fealty to a particular noble.
- Character must discard all other magic items.
- Character must worship a particular deity.
- Character must change her name to a specific name.
- Character must be of a particular class.
- Character must sacrifice 2 points of constitution once. If the constitution returns, the item ceases functioning.
- Item must be cleansed with holy water each day.
- Item must be used to kill a living creature each day.
- Item must be bathed in volcanic lava once per month.
- Item must be used at least once a day, or it won't function again for its current possessor.
- Item must draw blood when wielded (weapons only). It can't be put away or exchanged for another weapon until it has scored a hit.
- Item must have a particular spell cast upon it each day (such as *bleed*, *atonement*, or *animate object*).

Requirements are so dependent upon suitability to the item that they should never be determined randomly. An item with a requirement that is also intelligent often imposes its requirement through its personality. If the requirement is not met, the item ceases to function.

Drawback: Items with drawbacks are still beneficial to the possessor, but they also carry a curse. Although sometimes drawbacks occur only when the item is used

or held, usually the drawback remains with the character for as long as she has the item.

d%	Drawback
01–04	Owner's hair grows 1 inch longer. Only happens once.
05–09	Owner either shrinks 1d4 inches or grows that much taller. Only happens once.
10–13	Temperature around item is 10°F cooler than normal.
14–17	Temperature around item is 10°F warmer than normal.
18–21	Owner's hair color changes.
22–25	Owner's skin color changes.
26–29	Owner bears an identifying mark like a tattoo, weird glow, etc.
30–32	Owner's sex changes.
33–34	Owner's race or kind changes.
35	Owner is afflicted with incurable disease.
36–39	Item continually emits a disturbing sound.
40	Item looks ridiculous (garishly colored, silly shape, glows bright pink ...).
41–45	Owner becomes selfishly possessive about the item.
46–49	Owner is paranoid about losing or damaging the item.
50–51	Owner's alignment changes.
52–54	Owner attacks nearest creature (5% chance per day).
55–57	Owner stunned for 1d4 rounds once item functions.
58–60	Owner's vision is blurry.
61–64	Owner loses one level (drain).
65	Owner loses two levels (drain).
66–70	Owner must save each day or take 1 Int damage.
71–75	Owner must save each day or take 1 Wis damage.
76–80	Owner must save each day or take 1 Cha damage.
81–85	Owner must save each day or take 1 Con damage.
86–90	Owner must save each day or take 1 Str damage.
91–95	Owner must save each day or take 1 Dex damage.
96	Owner is <i>polymorphed</i> into a specific creature (5% chance each day).
97	Owner cannot cast magic-user spells.
98	Owner cannot cast cleric or druid spells.
99	Owner cannot cast any spells.
00	Pick one above or make one up.

Specific Cursed Items

Specific cursed Items are provided as examples of cursed items. A *detect magic* spell yields a misleading aura and strength, often indicating that the item is a non-cursed item of similar sort. An *identify* spell only has a 1% chance per caster level to reveal a cursed item's true properties, including the cursed aspect. *Analyze dweomer* reveals the true nature of a cursed item.

d%	Item	Value
01–05	<i>Incense of obsession</i>	200 gp
06–15	<i>Ring of clumsiness</i>	500 gp
16–20	<i>Amulet of inescapable location</i>	1,000 gp
21–25	<i>Stone of weight</i>	1,000 gp

26–30	<i>Bracers of defenselessness</i>	1,200 gp
31–35	<i>Gauntlets of fumbling</i>	1,300 gp
36–40	<i>-2 sword, cursed</i>	1,500 gp
41–43	<i>Armor of rage</i>	1,600 gp
44–46	<i>Medallion of thought projection</i>	1,800 gp
47–52	<i>Flask of curses</i>	2,100 gp
53–54	<i>Dust of sneezing and choking</i>	2,400 gp
55	<i>Helm of opposite alignment</i>	4,000 gp
56–60	<i>Potion of poison</i>	5,000 gp
61	<i>Broom of animated attack</i>	5,200 gp
62–63	<i>Robe of powerlessness</i>	5,500 gp
64	<i>Vacuous grimoire</i>	6,000 gp
65–68	<i>Spear, cursed backbiter</i>	7,500 gp
69–70	<i>Armor of arrow attraction</i>	9,000 gp
71–72	<i>Net of snaring</i>	10,000 gp
73–75	<i>Bag of devouring</i>	—
76–80	<i>Mace of blood</i>	16,000 gp
81–85	<i>Robe of vermin</i>	16,500 gp
86–88	<i>Periapt of foul rotting</i>	17,000 gp
89–92	<i>Sword, berserking</i>	17,500 gp
93–96	<i>Boots of dancing</i>	30,000 gp
97	<i>Crystal hypnosis ball</i>	—
98	<i>Necklace of strangulation</i>	60,000 gp
99	<i>Cloak of poisonousness</i>	62,000 gp
00	<i>Scarab of death</i>	80,000 gp

Amulet of Inescapable Location: This device seems to be an *amulet of proof against detection and location*, but actually gives the wearer a –10 penalty on all saving throws against divinations.

Armor of Arrow Attraction: Magical analysis indicates that this armor is a suit of +3 *platemail*. However, the armor is cursed. It works normally with regard to melee attacks but actually serves to attract ranged weapons. The wearer takes a –10 penalty to AC against any attack by a ranged weapon. The true nature of the armor does not reveal itself until the character is targeted.

Armor of Rage: This armor is similar in appearance to *armor of command* and functions as a suit of +1 *platemail*. However, when it is worn, the armor causes the character to take a –4 penalty to charisma. All unfriendly characters within 300' have a +1 bonus on attack rolls against her. The effect is not noticeable to the wearer or those affected.

Bag of Devouring: This bag appears to a *bag of holding*. Any substance of animal or vegetable nature is subject to swallowing if put in the bag. The *bag of devouring* is 90% likely to ignore any initial intrusion, but any time thereafter that it senses living flesh within (such as if someone reaches into the bag to pull something out), it is 60% likely to close around the offending member and

attempt to draw the whole victim in. The bag has a +8 bonus on grapple attacks.

The bag can hold up to 30 cubic feet of matter. It acts as a *bag of holding type I*, but each hour it has a 5% cumulative chance of swallowing the contents and then spitting the stuff out on some other plane. Creatures drawn within are consumed in 1 round. The bag destroys the victim's body and prevents any form of raising or resurrection that requires part of the corpse. There is a 50% chance that *wish*, *miracle* or *true resurrection* can restore a devoured victim to life. Check once for each destroyed creature. If the check fails, the creature cannot be brought back to life by mortal magic.

Boots of Dancing: These boots initially appear and function as one of the other kinds of magic boots. But when the wearer is in (or fleeing from) melee combat, *boots of dancing* impede movement, making him behave as if *irresistible dance* had been cast on him. Only remove curse enables the wearer to be rid of the boots once their true nature is revealed.

Bracers of Defenselessness: These appear to be *bracers of armor +5* and actually serve as such until the wearer is attacked in anger by an enemy with Hit Dice equal to or greater than her level. At that moment and thereafter, the bracers cause a -5 penalty to AC. Once their curse is activated, *bracers of defenselessness* can be removed only by means of *remove curse*.

Broom of Animated Attack: This item is identical to a *broom of flying* by all tests short of attempted use. If a command is spoken, the broom does a loop-the-loop with its hopeful rider, dumping him on his head from 1d4+5 feet off the ground. The broom then attacks the victim, swatting the face with the straw or twig end and beating him with the handle end.

The broom gets two attacks per round with each end, thus four attacks per round. It attacks with a +5 bonus. The straw end causes a victim to be blinded for 1 round when it hits. The handle deals 1d6 points of damage when it hits. The broom has AC 13 and 22 hit points.

Cloak of Poison: This cloak is made of wool or leather. A *detect poison* spell can reveal the presence of poison in the cloak's fabric. The garment can be handled without harm, but as soon as it is donned, the wearer is killed instantly unless she succeeds on a saving throw. Once donned, the cloak can be removed only with a *remove curse* spell; doing this destroys the magical property of the cloak. If a *neutralize poison* spell is then used, it is

possible to revive the victim with *raise dead* or *resurrection*.

Crystal Hypnosis Ball: This cursed item is indistinguishable from a normal *crystal ball*. However, anyone attempting to use the scrying device becomes fascinated for 1d6 minutes, and a telepathic suggestion is implanted in his mind. The user of the device believes that the desired creature or scene was viewed, but actually he came under the influence of a powerful magic-user, lich or some power or being from another plane. Each further use brings the *crystal hypnosis ball* gazer deeper under the influence of the controller, either as a servant or a tool. Note that throughout this time, the user remains unaware of his subjugation.

Dust of Sneezing and Choking: This fine dust appears to be *dust of appearance*. If cast into the air, it causes those within a 20' spread to fall into fits of sneezing and coughing that causes 1d6 points of constitution damage per minute. Those who succeed on either saving throw are nonetheless disabled by choking for 5d4 rounds.

Flask of Curses: This item looks like an ordinary beaker, bottle, container, decanter, flask, or jug. It may contain a liquid, or it may emit smoke. When the flask is first unstoppered, all within 30' must save or be cursed, taking a -2 penalty on attack rolls, saving throws and action checks until a *remove curse* spell is cast upon them.

Gauntlets of Fumbling: These gauntlets may be of supple leather or heavy protective material suitable for use with armor. In the former instance, they appear to be *gloves of dexterity*. In the latter case, they appear to be *gauntlets of ogre power*. The gauntlets perform according to every test as if they were what they seem until the wearer finds herself under attack or in a life-and-death situation. At that time, the curse is activated. The wearer becomes fumble-fingered, with a 50% chance each round of dropping anything held in either hand. The gauntlets also lower dexterity by 2 points. Once the curse is activated, the gloves can be removed only by means of a *remove curse* spell.

Helm of Opposite Alignment: This metal hat looks like a typical helmet. When placed upon the head, however, its curse takes effect (save negates). On a failed save, the alignment of the wearer is altered to either the opposite alignment or to one of the extreme alignments for Neutrals. Alteration in alignment is mental as well as moral, and the individual changed by the magic thoroughly enjoys his new outlook. A character who succeeds on his save can continue to wear the helmet

without suffering the effect of the curse, but if he takes it off and later puts it on again, another save is required. The curse only works once; that is, a character whose alignment has been changed cannot change it again by donning the helmet a second time.

Only a *wish* or a *miracle* can restore former alignment, and the affected individual does not make any attempt to return to the former alignment. If a character of a class with an alignment requirement is affected, an *atonement* spell is also needed if the curse is to be obliterated. Once a *helm of opposite alignment* has functioned it loses its magic.

Incense of Obsession: These blocks of incense appear to be *incense of meditation*. If meditation and prayer are conducted while incense of obsession is burning nearby, its odor and smoke cause the user to become totally confident that her spell ability is superior, due to the magic incense. The user is determined to use her spells at every opportunity, even when not needed or when useless. The user remains obsessed with her abilities and spells until all have been used or cast, or for 24 hours.

Mace of Blood: This *+3 footman's mace* must be coated in blood every day, or its bonus fades away (until the mace is coated again). The character using this mace must make a saving throw every day it is within his possession or become Chaotic (CE).

Medallion of Thought Projection: This device seems like a *medallion of ESP*, even down to the range at which it functions, except that the thoughts overheard are muffled and distorted, requiring a saving throw to sort out. However, while the user thinks she is picking up the thoughts of others, all she is really hearing are figments created by the medallion itself. These illusory thoughts always seem plausible and thus can seriously mislead any who rely upon them. What's worse, unknown to her, the cursed medallion actually broadcasts her thoughts to creatures in her path within 60', thus alerting them to her presence.

Necklace of Strangulation: A *necklace of strangulation* appears to be a rare and wondrous piece of valuable jewelry and, short of the use of something as powerful as a *miracle* or a *wish*, can only be identified as a cursed item when placed around a character's neck. The necklace immediately constricts, dealing 6 points of damage per round. It cannot be removed by any means short of *wish* or *miracle* and remains clasped around the victim's throat even after his death. Only when he has decayed to a dry skeleton (after one month) does the necklace loosen, ready for another victim.

Net of Snaring: This net provides a +3 bonus on attack rolls but can only be used underwater, thus making it a somewhat useful item rather than what most would really call a cursed item. Underwater, it can be commanded to fly up to 30' to trap a creature.

Periapt of Foul Rotting: This engraved gem appears to be of little value. If any character keeps the periapt in her possession for more than 24 hours, she contracts a terrible rotting affliction that permanently drains 1 point of dexterity, constitution and charisma every week. The periapt (and the affliction) can be removed only by application of *remove curse* followed by *cure disease* and then *heal*, *miracle*, *limited wish*, or *wish*. The rotting can also be countered by crushing a *periapt of health* and sprinkling its dust upon the afflicted character, whereupon the *periapt of foul rotting* crumbles to dust.

Potion of Poison: This potion has lost its once beneficial magical abilities and has become a lethal poison.

Robe of Powerlessness: A *robe of powerlessness* appears to be a magic robe of another sort. As soon as a character dons this garment, she takes a -10 penalty to strength and intelligence (minimum 3), forgetting spells and magic knowledge accordingly. The robe is easily removed, but in order to restore mind and body, the character must receive *remove curse* followed by *heal*.

Robe of Vermin: The wearer notices nothing unusual when the robe is donned, other than that it offers great magical defense (as a *cloak of protection +4*). However, as soon as he is in a situation requiring concentration and action against hostile opponents, the true nature of the garment is revealed. The wearer immediately suffers a multitude of bites from the insects that magically infest the garment. He must cease all other activities in order to scratch, shift the robe, and generally show signs of the extreme discomfort caused by the pests.

The wearer takes a -3 penalty on initiative checks and a -2 penalty on all attack rolls and saving throws. If he tries to cast a spell, he must make a saving throw (penalty equal to the spell's level) or lose the spell.

Ring of Clumsiness: This ring operates exactly like a *ring of feather falling*. However, it also makes the wearer clumsy. She takes a -4 penalty to dexterity (min. 3) and has a 20% chance of spell failure when trying to cast any magic-user spell.

Scarab of Death: This small pin appears to be any one of the various beneficial amulets, brooches, or scarabs. However, if it is held for more than 1 round or carried by

a living creature for 1 minute, it changes into a horrible burrowing beetle-like creature. The thing tears through any leather or cloth, burrows into flesh, and reaches the victim's heart in 1 round, causing death. A saving throw allows the wearer to tear the scarab away before it burrows out of sight, but he still takes 3d6 points of damage. The beetle then returns to its scarab form. Placing the scarab in a container of wood, ceramic, bone, ivory, or metal prevents the monster from coming to life and allows for long-term storage of the item.

Spear, Cursed Backbiter: This is a +2 *spear*, but each time it is used in melee against a foe and the attack roll is a natural "1", it damages its wielder instead of the intended target. When the curse takes effect, the spear curls around to strike its wielder in the back, automatically dealing the damage to the wielder. The curse even functions when the spear is hurled, and in such a case the damage to the hurler is doubled.

Stone of Weight (Loadstone): This stone appears to be a dark, smoothly polished stone. It reduces the possessor's base land speed to one-half of normal. Once picked up, the stone cannot be disposed of by any non-magical means. If it is thrown away or smashed, it reappears somewhere on his person. If *remove curse* is cast on a *loadstone*, the item may be discarded normally and no longer haunts the individual.

-2 Sword, Cursed: This longsword performs well in practice, but when used against an opponent in combat, it causes its wielder to take a -2 penalty on attack rolls. All damage dealt is also reduced by 2 points. After one week in a character's possession, the sword always forces that character to employ it rather than another weapon. The sword's owner automatically draws it and fights with it even when she meant to draw or ready some other weapon. The sword can be gotten rid of only by means of *limited wish*, *wish* or *miracle*.

Sword, Berserking: This item appears to have the characteristics of a +2 *greatsword*. However, whenever the sword is used in battle, its wielder goes berserk (gaining all the benefits and drawbacks of the barbarian's rage ability). He attacks the nearest creature and continues to fight until unconscious or dead or until no living thing remains within 30'. Although many see this sword as a cursed object, others see it as a boon.

Vacuous Grimoire: A book of this sort looks like a normal one on some mildly interesting topic. Any character that opens the work and reads so much as a single word therein must make two saving throws. The

first is to determine if the reader takes 1 point of permanent intelligence drain. The second is to find out if the reader takes 2 points of permanent wisdom drain. To destroy the book, a character must burn it while casting *remove curse*. If the grimoire is placed with other books, its appearance instantly alters to conform to the look of those other works.

Artifacts

Artifacts are legendary relics that whole campaigns can be based on. No table has been included to randomly generate specific artifacts, since these items should only enter a campaign through deliberate choice.

Book of Infinite Spells: This work bestows upon any character of any class the ability to use the spells within its pages. However, any character not already able to use spells loses one level for as long as the book is in her possession or while she uses its power. A *Book of Infinite Spells* contains 1d8+22 pages. The nature of each page is determined by a dice roll: 01-50, magic-user spell; 51-80, cleric spell; 81-00, druid spell.

Once a page is turned, it can never be flipped back, paging through a *Book of Infinite Spells* is a one-way trip. If the book is closed, it always opens again to the page it was on before the book was closed. When the last page is turned, the book vanishes.

Once per day the owner of the book can cast the spell to which the book is opened. If that spell happens to be one that is on the character's class spell list, she can cast it up to four times per day. The pages cannot be ripped out without destroying the book. Similarly, the spells cannot be cast as scroll spells, nor can they be copied into a spell book, as their magic is bound up permanently within the book itself.

The owner of the book need not have the book on her person in order to use its power. The book can be stored in a place of safety while the owner is adventuring and still allow its owner to cast spells by its power.

Each time a spell is cast from the book there is a chance that this causes the page to magically turn despite all precautions. The owner knows this and may even benefit from the turning by gaining access to a new spell. The chance of a page turning depends on the spell the page contains and what sort of spell caster the owner is.

Condition	Chance
Caster employing a spell usable by own class and level	10%
Caster employing a spell not usable by own class and level	20%
Non-spell caster employing cleric or druid spell	25%
Non-spell caster employing magic-user spell	30%

Treat each spell use as if a scroll were being employed.

Deck of Many Things: A *Deck of Many Things* is found in a box or leather pouch. Each deck contains a number of cards or plaques made of ivory or vellum. Each is engraved with glyphs, characters, and sigils. As soon as one of these cards is drawn from the pack, its magic is bestowed upon the person who drew it.

The character with a *Deck of Many Things* who wishes to draw a card must announce how many cards she will draw before she begins. Cards must be drawn within 1 hour of each other and a character can never again draw from this deck any more cards than she has announced. If the character does not willingly draw her allotted number (or if she is somehow prevented from doing so), the cards flip out of the deck on their own. If the jester is drawn, the possessor of the deck may elect to draw two additional cards.

Each time a card is taken from the deck, it is replaced (making it possible to draw the same card twice) unless the draw is the jester or the fool, in which case the card is discarded from the pack. A deck of many things contains 22 cards. The effects of each card, summarized on the table, are fully described below.

Card	Plaque	Effect
Clubs		
Ace	Talons	All magic items you possess disappear permanently
Ten	Idiot	Intelligence drain. You may draw again
Jack	Skull	Defeat wraith or be destroyed
Queen	Flames	Enmity between you and an outsider
King	The Void	Body functions, but soul trapped elsewhere
Diamonds		
Ace	Vizier	Know the answer to your next dilemma
Ten	Comet	Defeat the next monster you meet to gain one level
Jack	Star	Gain +2 bonus to one ability score
Queen	Moon	You are granted 1d4 wishes
King	Sun	Gain random wondrous item and 50,000 XP

Hearts

Ace	The Fates	Avoid any situation you choose ... once
Ten	Gem	Gain 25 pieces of jewelry or 50 gems
Jack	Knight	Gain the service of a 4th-level fighter
Queen	Key	Gain a random magic weapon
King	Throne	Gain a small keep

Spades

Ace	Donjon	You are imprisoned
Ten	Balance	Change alignment instantly
Jack	Rogue	One friend turns against you
Queen	Euryale	-1 penalty on all saves henceforth
King	Ruin	Lose all wealth and property

Joker

Trademark	Fool	Lose 10,000 XP and you must draw again
No trademark	Jester	Gain 10,000 XP or two more draws

Balance: The character must change to a radically different alignment. If the character fails to act according to this alignment, she loses a level.

Comet: The character must single-handedly defeat the next hostile monster or monsters encountered, or the benefit is lost. If successful, the character gains enough XP to attain the next experience level.

Donjon: This card signifies imprisonment by the spell *imprisonment* or by a powerful being. In any case, all gear and spells are stripped from the victim. Draw no more cards.

Euryale: The medusa-like visage of this card brings a curse that only the fates card or a deity can remove. The -1 penalty on all saving throws is otherwise permanent.

Fates: This card enables the character to avoid even an instantaneous occurrence if so desired, for the fabric of reality is unraveled and re-spun. Note that it does not enable something to happen. It can only stop something from happening or reverse a past occurrence. The reversal is only for the character that drew the card; other party members may have to endure the situation.

Flames: Hot anger, jealousy, and envy are but a few of the possible motivations for the enmity of an outsider. The enmity cannot be ended until one of the parties is dead. Determine the outsider randomly and assume that it attacks the character within 1d20 days.

Fool: The payment of XP and redraw are mandatory. This card is always discarded when drawn, unlike all others except the jester.

Gem: This card indicates wealth. The jewelry is gold set with gems, each piece worth 2,000 gp. The gems are worth 1,000 gp each.

Idiot: This card causes 1d4+1 points of intelligence drain. An additional draw is optional.

Jester: This card is always discarded when drawn, unlike all others except the fool. The redraws are optional.

Key: The magic weapon granted must be one usable by the character. It suddenly appears out of nowhere in the character's hand.

Knight: The fighter appears out of nowhere and serves loyally until death. He or she is of the same race (or kind) and sex as the character.

Moon: This card sometimes bears the image of a moonstone with the number of wishes shown as gleams therein. These wishes are the same as those granted by the magic-user spell and must be used within a number of minutes equal to the number received.

Rogue: When this card is drawn, one of the character's NPC followers becomes forever hostile. If the character has no followers, the enmity of some powerful personage, community or religious order is substituted. The hatred is secret until the time is right for it to be revealed with devastating effect.

Ruin: As implied by its name, when this card is drawn, all non-magical possessions of the drawer are lost.

Skull: A wraith appears. This creature cannot be turned. The character must fight it alone. If others help, they get wraiths to fight as well. If the character is slain, she is slain and cannot be revived, even with a *wish*.

Star: The 2 points are added to any ability the character chooses. They cannot be divided among two abilities.

Sun: Roll for a wondrous item until an item useful to the character is generated.

Talons: When this card is drawn, every magic item owned or possessed by the character is instantly and irrevocably gone.

Throne: The character becomes a true leader in people's eyes. The castle gained appears in any open area she wishes (but the decision must be made within 1 hour).

Vizier: This card empowers the character drawing it with the one-time ability to call upon a source of wisdom to solve any single problem or answer any single question upon her request. The query or request must be made within one year. Whether the information gained can be successfully acted upon is another question entirely.

The Void: This black card spells instant disaster. The character's body continues to function as though comatose, but her psyche is trapped in a prison within an object on a far plane or planet, possibly in the possession of an outsider. *Wish* or *miracle* does not bring the character back, instead merely revealing the plane of entrapment. Draw no more cards.

Hammer of Thunderbolts: This +3 *warhammer* deals 4d6 points of damage on any hit. It can be thrown up to 60' and returns to the thrower's hand the next round. Further, if the wielder wears a *belt of giant strength* and *gauntlets of ogre power* and he knows that the hammer is the *Hammer of Thunderbolts*, the weapon can be used to full effect: It gains a total +5 magic bonus, increases strength by +10 when using this weapon, and strikes dead any giant it hits in combat (saving throw negates death but not the damage).

When hurled, on a successful attack the hammer emits a clap of thunder, causing all creatures within 90' to be stunned for 1 round (save negates).

The Moaning Diamond: The *Moaning Diamond* appears to be an uncut diamond the size of a human fist. At all times, it gives forth a baleful moaning sound, as if in pain. Despite the noise, the *Moaning Diamond* is not evil. The wielder of the stone can, three times per day, call upon it to reshape earth and stone as if by *stone shape*, affecting 5,000 cubic feet of material. The *Moaning Diamond* can summon a huge earth elemental with maximum hit points that serves the caster until it is slain. Only one such elemental can be summoned at a time. If it is slain, a new creature cannot be summoned for 24 hours.

The Orbs of Dragonkind: Each of these fabled orbs contains the essence and personality of an ancient dragon of a different variety (one for each of the types of chromatic and metallic dragons). The bearer of an orb can dominate dragons of its particular variety within 500' (as *dominate monster*), the dragon being forced to make a saving throw at -5 to resist. Magic resistance is not useful against this effect.

Each *Orb of Dragonkind* bestows upon the wielder the AC and saving throw bonuses of the dragon within. These values replace whatever values the character would

otherwise have, whether they are better or worse. These values cannot be modified by any means short of ridding the character of the orb. A character possessing an *Orb of Dragonkind* is immune to the breath weapon of the dragon variety keyed to the orb. Finally, a character possessing an orb can herself use the breath weapon of the dragon in the orb three times per day.

All *Orbs of Dragonkind* can be used to communicate verbally and visually with the possessors of the other orbs. The owner of an orb knows whether there are dragons within 10 miles at all times. For dragons of the orb's particular variety, the range is 100 miles. If within 1 mile of a dragon of the orb's variety, the wielder can determine the exact location and age of the creature. The bearer of one of these orbs earns the enmity forever of all dragonkind for profiting by the enslavement of one of their kin, even if she later loses the item.

Each orb also has an individual power that can be invoked once per round at 10th caster level.

- *Orb of Black Dragonkind: Fly.*
- *Orb of Blue Dragonkind: Haste.*
- *Orb of Brass Dragonkind: Teleport.*
- *Orb of Bronze Dragonkind: Scrying.*
- *Orb of Copper Dragonkind: Suggestion.*
- *Orb of Gold Dragonkind:* The owner of this orb can call upon any power possessed by one of the other orbs, including the dominate and breath weapon abilities but not AC, save bonuses, or breath weapon immunity—but can only use an individual power once per day. She can use dominate on any other possessor of an orb within 1 mile (save negates).
- *Orb of Green Dragonkind: Spectral hand.*
- *Orb of Red Dragonkind: Wall of fire.*
- *Orb of Silver Dragonkind: Cure critical wounds.*
- *Orb of White Dragonkind:* Resistance to cold.

Philosopher's Stone: This rare substance appears to be an ordinary, sooty piece of blackish rock. If the stone is broken open, a cavity is revealed at the stone's heart. This cavity is lined with a magical type of quicksilver that enables any caster of magic-user spells to transmute iron and lead into silver and gold. A *Philosopher's Stone* can turn from up to 5,000 pounds of iron into silver, or up to 1,000 pounds of lead into gold. However, the quicksilver

becomes unstable once the stone is opened and loses its potency within 24 hours, so all transmutations must take place within that period.

The quicksilver found in the center of the stone may also be put to another use. If mixed with any *potion of healing* while the substance is still potent, it creates a special *oil of life* that acts as *true resurrection* for any dead body upon which it is sprinkled.

The Saint's Mace: This relic appears to be a simple, well-used cudgel, but this simple appearance hides great power. *The Saint's Mace* functions as a *+5 footman's mace* with the abilities of a *holy avenger* and *mace of disruption*. The wielder can project beams of *searing light* from the mace at will, at caster level 20th.

The Shadowstaff: This artifact was crafted centuries ago, weaving together the wispy strands of shadow itself into a twisted black staff. *The Shadowstaff* makes the wielder slightly shadowy and incorporeal, granting him a +4 bonus to AC and saving throws vs. breath weapons, rays and traps. However, in bright light or in absolute darkness, the wielder takes a -2 penalty on all attack rolls and saving throws.

The Shadowstaff also has these powers.

- **Summon Shadows:** Three times per day the staff may summon 2d4 shadows. Immune to turning, they serve the wielder as if called by *summon monster V*.
- **Summon Nightshade:** Once per month, the staff can summon a nightshade that serves the wielder as if called by *summon monster IX*.
- **Shadow Form:** Three times per day the wielder can become a living shadow, with all the movement powers granted by *gaseous form*.
- **Shadow Bolt:** Three times per day the staff can project a ray attack that deals 10d6 points of cold damage to a single target. The shadow bolt has a range of 100'.

The Shield of the Sun: This *+5 shield*, emblazoned with the symbol of the sun, allows the wielder to cast spells as if she were a 20th-level paladin. The spells gained are cumulative with any existing spells per day that the character might have, even if she's already a paladin. *The Shield of the Sun* also grants magic resistance 20% to its wielder. It absorbs the first 10 points of damage from any energy attack (fire, cold, acid, electricity or sonic). In return for all this, once per year the shield's owner must undertake a quest (no save allowed) at the behest of a

Lawful deity. A Chaotic character loses four levels if she attempts to use this artifact.

Sphere of Annihilation: The *Sphere of Annihilation* is a globe of absolute blackness, a ball of nothingness 2' in diameter. The object is actually a hole in the continuity of the multiverse. Any matter that comes in contact with a sphere is instantly sucked into the void, gone, and utterly destroyed. Only the direct intervention of a deity can restore an annihilated character.

The *Sphere of Annihilation* is static, resting in some spot as if it were a normal hole. It can be caused to move, however, by mental effort (think of this as a mundane form of telekinesis, too weak to move actual objects but a force to which the sphere, being weightless, is sensitive).

Control of the sphere can be established from as far away as 40' (the character need not approach too closely). To gain control, the character has a percent chance equal to their level + intelligence modifier x 5%.

Once control is established, it must be maintained by continuing to concentrate each round. For as long as a character maintains control in subsequent rounds, he can control the sphere from a distance of 40' + 10' per character level. The sphere's movement rate is 10'.

If a character stops concentrating, the sphere slides 10' in the direction of the character attempting to move it.

If two or more creatures vie for control of a sphere of annihilation, they must each roll 1d20 and add their intelligence, wisdom and charisma bonuses. Whoever rolls highest controls the sphere during that round.

Should *gate* be cast upon the *Sphere of Annihilation*, there is a 50% chance (01–50) that the spell destroys it, a 35% chance (51–85) that the spell does nothing and a 15% chance (86–100) that a gap is torn in the spatial fabric, catapulting everything within 180' into random plane. If a *rod of cancellation* touches the *Sphere of Annihilation*, they negate each other in a tremendous explosion. Everything within a 60' radius takes 2d6 x 10 points of damage. *Dispel magic* and *mage's disjunction* have no effect on a sphere.

Staff of the Magi: A long wooden staff, shod in iron and inscribed with sigils and runes of all types, this potent artifact contains many spell powers and other functions. The following powers of the *Staff of the Magi* do not use charges: *Detect magic*, *enlarge person*, *hold portal*, *light*, *mage armor* and *mage hand*.

The following powers use one charge per use: *Dispel magic*, *fireball* (10d6), *ice storm*, *invisibility*, *knock*, *lightning bolt* (10d6), *passwall*, *pyrotechnics*, *wall of fire* and *web*.

These powers use two charges per use: *Monster summoning IX*, *plane shift* and *telekinesis* (max 400 lb.).

The *Staff of the Magi* gives the wielder magic resistance 60%. If this is willingly lowered, the staff can be used to absorb magic-user spell energy directed at its wielder, as a *rod of absorption*. Unlike the rod, this staff converts spell levels into charges. If the staff absorbs enough spell levels to exceed its limit of 50 charges, it explodes as if a retributive strike had been performed. The wielder has no idea how many spell levels are cast at her, for the staff does not communicate this knowledge.

The *Staff of the Magi* can purposely be broken for a retributive strike. All charges in the staff are released in a 30' radius. All within 10' of the broken staff take hit points of damage equal to 8 times the number of charges in the staff. Those 11' to 20' away take damage equal to 6 times the number of charges. Those 21' to 30' away take damage equal to 4 times the number of charges.

The character breaking the staff has a 50% chance of being sent to a random plane, but if she does not, the explosive release of spell energy destroys her.

Talisman of Pure Good: A Lawful cleric who possesses this talisman can cause a flaming crack to open at the feet of an anti-cleric who is up to 100' away. The intended victim is swallowed up forever and sent hurtling to the center of the earth. The wielder of the talisman must be Lawful and if he is not exceptionally pure in thought and deed the Chaotic character gains a saving throw to leap away from the crack. Obviously, the target must be standing on solid ground for this item to function.

A *talisman of pure good* has 6 charges. If a Neutral priest or druid touches one of these stones, he takes 6d6 points of damage. If an anti-cleric touches a stone, he takes 8d6 points of damage. All others are unaffected by the device.

Talisman of the Sphere: This small adamantine loop and handle are useless to those unable to cast magic-user spells, who take 5d6 points of damage merely from holding it. When held by a caster of magic-user spells concentrating on controlling the *Sphere of Annihilation*, the talisman doubles the character's modifier on his control check against another and allows him to control the sphere without concentrating.

Talisman of Reluctant Wishes: This talisman appears at first to be a *stone of controlling earth elementals*. When a character touches the talisman he must roll below his charisma score on 1d20. If he fails, the device acts as a *stone of weight*. Discarding or destroying it results in 5d6 points of damage to the character and the disappearance of the talisman. If his charisma throw succeeds the talisman remains with the character for 5d6 hours or until a *wish* is made with it. It then disappears. If he rolls a natural '20', the character finds it impossible to be rid of the talisman for as many months as he has points of charisma. The artifact grants one wish for every 6 points of a character's charisma. It grows warm and throbs whenever its possessor comes within 20' of a trap.

Regardless of which reaction results, the talisman disappears when its time period expires, leaving behind a 10,000 gp diamond in its stead.

Talisman of Ultimate Evil: As the *Talisman of Pure Good*, only reversed in terms of alignment.

Science (Optional)

Some TK's may wish to mingle science fiction into their fantasy. Perhaps their campaign is set long after a great war that left the world in a primitive state, and thus powerful scientific artifacts are hidden in ruins. The game could also be set on a Sword & Planet-type world, like Barsoom in Edgar Rice Burrough's *John Carter of Mars* series of books, which mingles objects of super science alongside swords and armor.

The following tables can be used to roll random scientific treasures to include in your dungeon ruins.

Science Items

d%	Science	Value
01-12	<i>Power crystals</i> (1d6)	100 gp each
13-18	<i>Bionics</i>	2,500 gp
19-21	<i>Blaster</i>	8,000 gp
22-23	<i>Body armor</i>	8,000 gp
24-25	<i>Brain implant</i>	1,500 gp
26-29	<i>Chronometer</i>	250 gp
30-34	<i>Cubitron</i>	1,500 gp
35-37	<i>Electro-whip</i>	550 gp
38-41	<i>Exoskeleton</i>	5,000 gp
42-44	<i>Flying discs</i>	10,000 gp
45-47	<i>Force belt</i>	1,000 gp
48-50	<i>Holo-projector</i>	1,000 gp

51-59	<i>Infrared goggles</i>	1,000 gp
60-61	<i>Jet belt</i>	10,000 gp
62-63	<i>Laser sword</i>	8,000 gp
64-68	<i>Mutagen capsule</i>	750 gp
69	<i>Preservation collar</i>	2,500 gp
70-75	<i>Ray gun</i>	7,500 gp
76-78	<i>Shock glove</i>	3,000 gp
79-83	<i>Sonic pick</i>	5,000 gp
84-89	<i>Spacesuit</i>	5,000 gp
90-92	<i>Throwing disc</i>	1,000 gp
93-97	<i>Tri-scanner</i>	2,500 gp
98-00	<i>Vibro-dagger</i>	4,000 gp

Scientific items do not work in quite the same way as magic items, though they may seem to the ignorant. Instead of command words, most scientific items must be activated by pressing the correct buttons. When an item is found, use the following flowcharts as characters attempt to figure out how to activate the item.

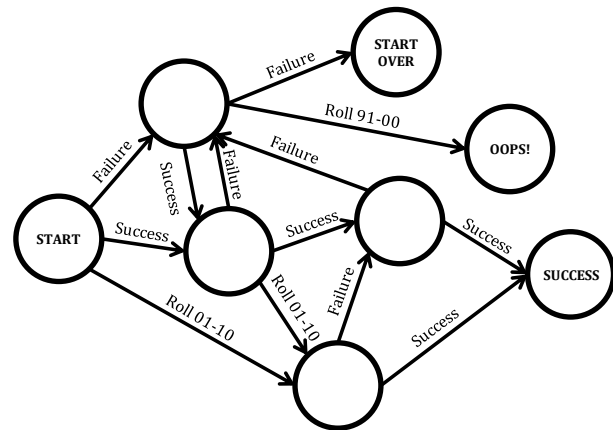

To use the flowchart, begin at the space labeled "START". Roll percentile dice. If the result is lower than the user's combined intelligence and wisdom scores, the roll is a success. If not, it is a failure. A roll of 01-10 is considered a major breakthrough, while a roll of 91-00 is considered a critical failure. With each roll, follow the lines to the next circle and roll again.

If you reach the circle labeled "SUCCESS", then you have figured out how the weapon works.

At "START OVER", you must return to the start position and begin rolling again (or give up).

If you reach the "OOPS!" circle, then the item is either ruined by your tampering if it is non-offensive, or it harms a random target in the vicinity.

Scientific Item Descriptions

Bionics: Bionics are scientific items that can be attached to living bodies, improving them in various ways. The table below determines what bionic part was found:

d6	Bionic
1-2	Arm (50% chance of either)
3	Eye
4	Leg (50% chance of either)
5	Pincer
6	Skullcap

A bionic part can either be held up to a freshly severed stump, in which case it attaches itself, or it can be cracked open and clamped over a body part. In this case, the bionic item destroys the part it was fastened over (a painful process) and ruins it for future use.

Bionic items are not powered by power crystals. Rather, they integrate themselves into one's own body, and power themselves biologically. Each bionic implant a character has "drains" one point of constitution while it is still implanted. When removed, the drained point of constitution is restored (though the body part is not).

Part	Impact
Arm	Increase strength by +1; if both arms are bionic, unarmed damage is 1d4
Eye	Darkvision to 60', find secret doors on roll of 1 to 4 on 1d6
Leg	Increase movement rate by +10'; leap 15' forward and 5' backward or straight up
Pincer	Gain melee attack for 1d6+1 damage; opponents suffer -2 penalty to save vs. grapple attacks
Skullcap	Increase intelligence by +2

Blaster: A *blaster* is a large device that fits over one's hand. It is powered by one's life force rather than a *power crystal*. Each time it is used, the user must pass a saving throw or suffer 1 point of constitution drain. This drain cannot be healed until the device is removed, which requires a character to roll d% under her combined intelligence and wisdom scores.

While attached to a character, the *blaster* can send out a laser blast (120' line, ignores half of armor's armor bonus, deals 3d6 fire damage) or a sonic blast (60' cone, 2d6 sonic damage, save vs. deafness for 1 hour, crystal and glass items must save or be shattered).

Body Armor: Body armor is made of high-tech plastic, with a rigid, glossy outer shell like plate armor and a

rubbery undercoat. The armor provides a base AC 16. When the helm is worn with the armor, the wearer is protected from poison gases and can breathe underwater for up to 10 minutes per charge.

Brain Implant: This item looks like a round electrode that is pressed against one's temple. When it touches flesh, it sends a small needle into the brain. It provides a +1 bonus to all intelligence tasks, and uses 1 charge from its *power crystal* per day of use. When its power runs out, it detaches from the skull.

Chronometer: This is a digital watch that tells time, works as a stopwatch and doubles as a compass. It uses one charge from its *power crystal* per month.

Cubitron: This cube-shaped computer is both capable of speaking and understanding speech. When it is activated, it can do the same work as a sage. Each day of operation uses 1 charge from the *power crystal*. The cube is 6 inches x 6 inches x 6 inches.

Electro-whip: This whip looks like nothing more than a handle until it is activated. It then projects a 6' long electric arc that deals 2d6 points of electricity damage on a hit. It uses 1 charge from its *power crystal* per round.

Exoskeleton: This metal exoskeleton looks something like fancy plate armor. It provides base AC 17 and when activated grants a +3 bonus to strength and a -2 penalty to dexterity. It uses 1 charge from its *power crystal* per minute of use.

Flying Discs: These 2' diameter metal discs can be adhered to the feet and provide the ability to levitate up to 60' off the ground, or fly at a speed of 60' per round. They consume 1 charge from their *power crystals* per 10 minutes of use.

Force Belt: This metal belt, when activated, creates the equivalent of a *shield* spell for 10 minutes per charge.

Holo-Projector: This device can produce an illusion (as *phantasmal force*) where it is placed on the ground. It consumes 1 charge per 10 minutes. Programming the device takes 10 minutes. The illusion fills 10 cubic feet.

Infrared Goggles: Provide darkvision to a range of 120'. Each minute of use uses 1 charge from a *power crystal*.

Jet Belt: These metal belts have small rockets on either side. When activated, they permit a character to fly up to 60' horizontally and 30' vertically in one round. After one round, the wearer must land. The belt uses 1 charge from its *power crystal* per round.

Laser Sword: These swords appear to be no more than a pommel until activated. They drain 1 charge from their *power crystal* per minute of use. *Laser swords* give off light as a torch and ignore half of non-magic armor's armor bonus. *Laser swords* deal 1d10 damage.

Mutagen Capsule: These look like modern gel-tabs, with glowing yellow goo inside. When swallowed, the goo rearranges the person's DNA. After one hour, the person suffers 1d4 random mutations:

d%	Mutation Type
01-02	Ability decay (-2 to random ability score)
03	Acid spit (1 point acid damage)
04	Adrenaline jolt (2 attacks per round)
05-07	Bloodlust (consume 1 pint blood per day or 2 Con dmg)
08-09	Brittle bones (+1d4 damage from blunt weapons and falls)
10	Claws (claw attack for 1d6 damage)
11-12	Combat fear (save or frightened by combat)
13	Darkvision (60' range)
14	Echolocation (blindsight to 60' range)
15	Elasticity (squeeze through spaces 4" wide or 6" high)
16	Energy absorption (resistance to one energy type)
17	Enhanced sense of smell (surprised on 1 on 1d6)
18	Enlarge (Grow 2' taller, count as one size category larger)
19	Exoskeleton (+2 to natural AC)
20	Extra eye (find secret doors on 1-2 on 1d6)
21-22	Extra finger on each hand, toe on each foot
23	Extra pair of arms
24	Fangs (bite attack for 1d4 damage)
25-27	Festering sores cover body, armor reduces speed by 5'
28	Fin grows from head down spine
29	Force barrier (as shield, 1/day)
30	Forked tongue
31-33	Frailty (-1 to save vs. poison, disease and fatigue)
34	Gills (can breathe water)
35	Great horns (gore attack for 1d4)
36-38	Heat/cold susceptibility (+1d6 damage from fire and cold)
39-40	Horns (too tiny for combat)
41	Hypersensitivity (surprised on 1 on 1d6)
42	Leap 30' forward or 10' backward or straight up
43-45	Lethargy (-1 to save vs. rays, traps and breath weapons)
46-48	Light sensitivity (-1 to attack and save in bright light)
49-50	Lost arm (roll randomly)
51	Pheromone attraction (+1 reaction bonus)
52-54	Pheromone repulsion (-1 reaction penalty)
55	Prehensile tail
56	Prickly (+1 grapple damage, cannot wear armor)
57	Radioactive (1 damage per round to those within 5', glow)
58-60	Rapid aging (double current age)
61	Rapid healing (heal 2 damage on self, 1/day)
62-64	Reduce base movement rate by 5' per round
65	Scaly armor (equivalent to leather armor)
66	Scaly skin (no bonus)

67	Skeletal reinforcement (-1 damage from blunt weapons, +2 save vs. falls)
68	Smokescreen (produce <i>obscuring mist</i> , 1/day)
69-70	Tail
71	Telekinetic (as <i>mage hand</i> , 1/day)
72	Telepathy (as <i>ESP</i> , 1/day)
73	Tentacle replaces arm, +2 to grapple attacks
74	Thick fur (as padded armor)
75	Thin fur
76-77	Thin skin (+1 damage from sharp weapons)
78	Ultra-immune system (+5 to save vs. disease and poison)
79-80	Ultraviolet allergy (daylight deals 1d6 damage per hour)
81-82	Unnatural eye color or shape
83-84	Unnatural hair color
85-86	Unnatural skin color
87-88	Unnatural voice (-1 reaction penalty)
89	Venomous bite (bite does 1 damage + Poison II)
90	Vexing voice (5' range, save or stunned for 1 round)
91	Wall crawler (+2 to climb sheer surfaces)
92-94	Weak immune system (-2 to save vs. poison and disease)
95-97	Weak mind (-1 to save vs. illusions and enchantments)
98	Webbed digits (+5' to swim speed)
99	Wings (fly at rat of 60' when unencumbered)
00	X-ray vision (as <i>ring of x-ray vision</i> , 1/day)

Power Crystal: These small, luminous crystals provide power for scientific items. Each crystal holds 10 charges when it is found (unless it is found in an object that was being used, in which case it has 1d10 charges).

Preservation Collar: This bizarre device clamps around a person's neck. If that person dies, the *preservation collar* keeps their head alive (assuming it was not head damage that caused the death), even if the head is removed from the body entirely (though it cannot easily be replaced). The body remains dead. The *preservation collar* uses 1 charge per hour from its *power crystal*.

Ray Gun: *Ray guns* are not completely alien to fantasy adventurers due to their familiarity with crossbows and possibly firearms. Each time a *ray gun* is fired, it uses up one or more charges from its *power crystal*. *Ray guns* come in the following varieties:

d10	Ray
1	Death Ray – as <i>finger of death</i> ; uses 10 charges
2-3	Freeze Ray – as <i>hold monster</i> ; uses 3 charges
4-5	Heat Ray – 2d6 fire damage; uses 2 charges
6-7	Sleep – as <i>sleep</i> ; uses 1 charge
8-10	Stun – Stunned for 1 minute; uses 1 charge

Shock Glove: This rubber glove is large and clumsy, and covered in a metal mesh. The *power crystal* sits in a setting on the back of the palm. When charged (which drains 1 charge from a power crystal), it can deliver 1d8 points of electricity damage to a creature touched.

Sonic Pick: This 8" long metal wand can be used to find secret doors, open locks and find and remove traps. The user must roll 1d20 under their intelligence score to successfully use the device. Each use uses 1 charge.

Spacesuit: These bulky outfits give a character cold and fire resistance, a +2 bonus on saving throws against negative energy effects, and while the helmet is attached they protect one from gases and permit them to breathe for up to 1 hour. The suit also lowers the character's movement rate by $\frac{1}{4}$. It does not require power except to permit breathing, in which case it uses 1 charge per hour.

Throwing Disc: These metal discs, when activated, create a luminous force field shaped like a disc 1' in diameter. They can be thrown up to 120' and deal 1d6 points of damage. The discs bounce off of solid surfaces. On an attack roll of 18 or higher, the thrower can bounce it off of one surface or creature and have it return to her hand. On an attack roll of 21 or higher, it can bounce off of two surfaces and return. On an attack roll of 24 or higher, it can bounce off of three surfaces and return, and so on. The thrower must chart the bounces before throwing it; if her attack roll is not high enough, the disc does not follow the indicated path. Each throw of the disc uses 1 charge from its *power crystal*.

Tri-Scanner: This device looks like a 1970's era tape recorder in terms of size and shape. When pointed, it can detect one of the following in a 60' cone: Creatures (gives general size and shape), substances (gives the type and quantity; does not denote magical or mundane), and energies (electricity, fire and sonic; positive and negative energy register as an unknown energy).

Each use of the *tri-scanner* uses 1 charge from its *power crystal* and lasts for 1 round.

Vibro-Dagger: These energized daggers vibrate at a weird harmonic, making them very deadly. They inflict 2d6 points of damage with each successful attack, and when used for a sundering attack, the attacked item suffers a -4 penalty on its item saving throw. Each use of the *vibro-dagger* uses 1 charge from its *power crystal*. It can also be used as a normal dagger.

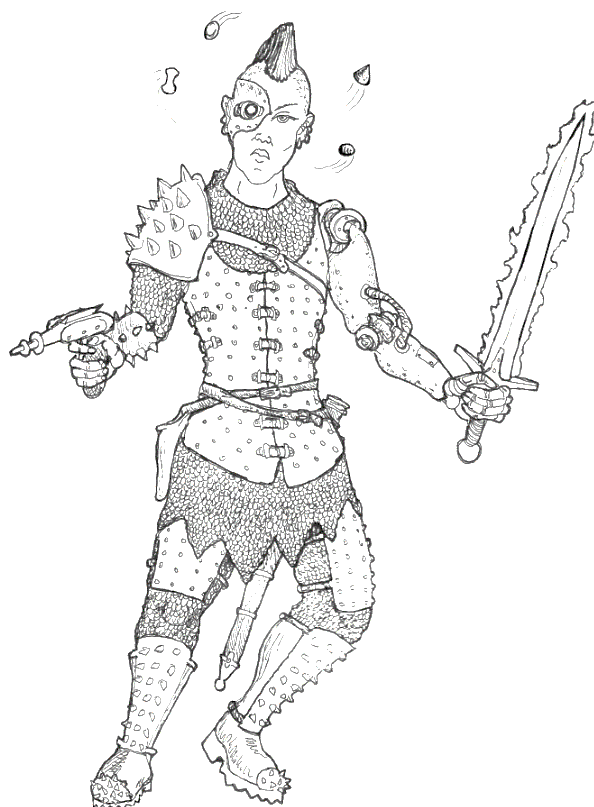

Appendix



Inspiration

amazing *Empire of the Petal Throne*

Edgar Rice Burroughs, a master of episodic adventures, as in the *Tarzan*, *Pellucidar* and *John Carter of Mars* books

Lin Carter, especially for his *Barbarian at World's End* stories, which are always imaginative

DeCamp and Pratt, for their Harold Shea series

Sir Arthur Conan Doyle, especially *The Lost World*

Lord Dunsany, whose stories are remarkably beautiful

Gardner Fox, who wrote many boisterous barbarian adventures

E. Gary Gygax, who invented the fantasy gaming medium, but also wrote stories starring Gord the Rogue

H. Rider Haggard, especially *King Solomon's Mines* (1885)

William Hope Hodgson, for his creepy and imaginative imagery, such as *The House on the Borderland* (1908)

J. Eric Holmes for everything he did for gaming

R. E. Howard, the master of barbarian adventure, best known for Conan and Red Sonya

Richard Jefferies, for *After London* (1885), a must-read if you're planning a wilderness adventure

Rudyard Kipling, for many adventures and ghost stories

C. S. Lewis, not only for his fantasy fiction, but for *The Discarded Image* (1964), the best primer on the medieval worldview I've read

H. P. Lovecraft, for the cosmic horror

George MacDonald, who inspired many of the folks on this list with his *Phantastes* (1858)

Arthur Machen, for his supernatural horror and fantasy

Abraham Merritt, especially *The People of the Pit* (1918), *The Moon Pool* (1919), *The Metal Monster* (1920) and *The Ship of Ishtar* (1924)

Tom Moldvay and Zeb Cook, for writing my favorite RPG

C. L. Moore, for Jirel of Joiry in *Dark God's Kiss* (1934)

The outside inspirations you use in your game are your own, but of the following folks have inspired me.

Authors

Barbara N. Blyfield's *Book of the Weird* (1973)

Poul Anderson, *Three Hearts and Three Lions* (1961)

Dave Arneson, co-author of the grand old game

Prof. M. A. R. Barker, for his

S. John Ross's *Encounter Critical* and everything else

Sir Walter Scott, for *Ivanhoe* (1820), among other stories (and the movie version is pretty good either)

Clark Ashton Smith, for his wondrous weird fantasy

Robert Louis Stevenson, who made pirates what they are today

J. R. R. Tolkien ... do I have to explain why?

Jack Vance, especially his *Dying Earth* series

Jules Verne, because science fantasy is still fantasy

James Ward's *Metamorphosis Alpha* and all the great gaming that it spawned

H. G. Wells, especially for the *Time Machine*

And of course Charles Perrault, Mother Goose and the Brothers Grimm!

Artists

Many fantasy artists have inspired me over the years, among them Denis Beauvais, Paul Bonner, Clyde Caldwell, Jeff Dee, Tony DiTerlizzi, Philippe Druillet. Stephen Fabian, Virgil Finlay, Frank Frazetta, Jim Holloway, Jeffrey Catherine Jones, Alan Lee, Todd Lockwood, Rodney Matthews, Will McLean, Peter Mullen, Russ Nicholson, Erol Otus, Keith Parkinson, Steve Prescott, Arthur Rackham, Wayne Reynolds, Bernie Wrightson, Barry Windsor Smith, David C. Sutherland III, Alex Toth, Dave Trampier, Waterhouse, N. C. Wyeth, and many more

Bloggers

There are many excellent "old school" bloggers to be found, but these are a few of my favorites.

Bat's "Ancient Vaults & Eldritch Secrets"

Trey Causey's "From the Sorcerer's Skull"

Mike Davison's "Sword +1"

"Delta's D&D Hotspot"

Greg Gorgonmilk's blog

James Hutching's "Teleli"

J. D. Jarvis' "Aeons and Auguries"

Noism's "Monsters and Manuals"

Jeff Rients' "Jeff's Gameblog"

Zak Smith's "Playing D&D with Porn Stars"

"Telecanter's Receding Rules"

Erik Tenkar's "Tenkar's Tavern"

Appendix

B

Conversions

Blood & Treasure is just one of many games that work off of a framework of characters classes, hit points, Armor Class and saving throws that are sometimes called “old school” games, or games in the OSR, or Old School Renaissance.

Broadly speaking, *Blood & Treasure* is compatible with these games, as well

as rules that use the old “d20” conventions.

Most conversions between *Blood & Treasure* and old school and d20 games can be performed on the fly. The following notes should aid in any conversions you require.

Hit Points

Blood & Treasure uses a base of 1d6 for monster and class hit points, with some classes using a larger dice and some a smaller dice. If you are converting from a system that is close to these values, you probably do not need to adjust monster or character hit points. If you are using a system that does not use a constitution score adjustment to hit points, you should remove those bonus hit points from a character. If you are using a system with different ability score modifiers, you likewise should make those adjustments, as they can add up quickly.

Armor Class

Blood & Treasure uses an ascending Armor Class system, in which AC increases from a base of ‘10’ based on the armor worn (or thickness of a monster’s hide) and, for characters, their dexterity modifier. Just as with hit points and constitution, if you are using a game that either does not modify AC by dexterity, or which uses a different set of modifiers, make sure you adjust AC accordingly.

If you are using a system that uses a descending Armor class system in which AC begins at ‘9’ or ‘10’ and then gets lower as a creature gets harder to hit, you can calculate AC as follows:

Ascending AC (AAC) to Descending AC (DAC), base ‘10’ = Subtract the AAC from 20

Ascending AC (AAC) to Descending AC (DAC), base ‘9’ = Subtract the AAC from 19

Descending AC (DAC), base ‘10’, to Ascending AC (AAC) = Subtract the DAC from 20

Descending AC (DAC), base ‘9’, to Ascending AC (AAC) = Subtract the DAC from 19

Saving Throws

Most games base a character’s saving throw values on the character’s class and level. Likewise, they base a monster’s saving throw values off of the monster’s Hit Dice and maybe type. Use the saving throw system/table in the game you are playing, referencing the character’s class and level or the monster’s Hit Dice.

Movement

Movement systems can be quite different from rule system to rule system. *Blood & Treasure* uses a base movement rate of 30’ per 6 second round. Other systems use a base movement of 40 feet or ‘12’.

To convert from base 30 to base 40, multiply the base 30 speed by 4 and then divide by 3, and vice versa for converting from base 40 to base 30.

To convert from a base 30 to base 12, multiply the base 30 speed by 4 and then divide by 10, and vice versa for converting from base 12 to 30.

Feats and Skills

If you are using a game that does not permit feats and skills, ignore them. If you are converting from such a system to *Blood & Treasure* and wish to use things like feats and skill points, you’ll need to choose feats and allocate skill points as you think proper (or just fake it!)

Races and Classes

If you are using a set of rules that does not have a comparable race or class, or does not allow certain race/class combinations, you should either convert the “out of bounds” NPC into a monster, choose the race and/or class that is closest (e.g. a *B&T* ranger could be a “fighting-man”, a sorcerer a “magic-user) or convert the race or class from one system to another.

Spells

Blood & Treasure uses a very large number of spells, many of which are not present in older role playing games. You can either use the *B&T* spells as they are written – they should be broadly compatible – or replace them with a spell that does exist in the older system.

If converting a spell from a more modern system to *Blood & Treasure*, keep in mind that *Blood & Treasure* does not, in general, use ranges, areas of effect or durations that scale with a spell caster's level. In most cases, these numbers are static in *Blood & Treasure*. Likewise, *Blood & Treasure* assumes that almost all spells are affected by magic resistance (or spell resistance) and that almost all spells permit a saving throw.

Changes from First to Second Edition

The book you hold in your hand is actually the second edition of *Blood & Treasure*. The first and second editions of the game are very similar, though some changes were made to the rules. In most cases, these changes can be ignored in play, as they represent minor changes to race or class abilities, or to spells. One can feel free to use one version or the other without disrupting play overmuch.

Most classes in second edition got a **bonus ability** to give them a bit more flavor. Assassins can brew poison, bards can carouse, barbarians are more skilled, clerics can convert, druids can sacrifice, fighters can tame monsters and use them as mounts, magic-users access arcane knowledge, paladins are more like medieval knights, rangers get hunting beasts, sorcerers can perform impromptu casting and can come from different bloodlines and thieves can quickly organize bands of rogues for capers and heists.

Some classes also changed the way they **attract followers**. In the first edition, all classes could build a stronghold at high levels and gain followers. Now, some classes gain followers at lower levels without building a stronghold. These are classes that are more suited to being wanderers, like the bard, ranger and sorcerer. Assassins now must conquer a stronghold through cunning and assassination, and paladins must conquer an evil stronghold and make it good. Barbarians can build a stronghold, or instead create a horde which they can use to invade civilization.

The largest change to class abilities is in terms of **spell-casting**. The first edition had spell lists for the assassin, bard, paladin and ranger, with which the second edition dispenses. Second edition assassins no longer cast spells, but can use magic-user scrolls at high levels. Bards now cast their spells from the magic-user spell list, paladins from the cleric spell list and rangers from the druid's. This consolidation led to the elimination of a few spells that were only cast-able by one of these classes. Re-introducing these spells from the first edition would not break the game.

Second edition *Blood & Treasure* also eliminates the idea of **0-level spells**, treating them instead as 1st level.

Second edition also divides spells into two types, **basic and advanced**. This allows Treasure Keepers who like a simpler and more streamlined game to ignore the advanced spells altogether, or, if they are used, to help differentiate specialty magic-users and clerics from normal members of those classes. Naturally, these distinctions can be entirely ignored if a TK prefers.

A few **spells** also had their names changed to keep two versions of a spell next to one another alphabetically. Thus *improved invisibility* became *invisibility II*, *minor* and *major creation* became *creation I* and *creation II*, etc.

Another change worth noting is in the way **saving throws** are made. The first edition of the game divided them into Fortitude, Reflex and Will saving throws, and had a different target number for each. The second edition has a single target number, and bonuses for different types of saving throws.

The **disease** rules were simplified in the second edition, as were special combat maneuvers.

Experience rewards for the most powerful monsters have been increased from 250 XP per Hit Dice to 500 XP. Some monsters were also modified to make them a bit more or less powerful. Feel free to use whichever stats you prefer when gaming, as the changes are usually not stark except for a few especially powerful monsters who were made more accessible to the play levels in which most groups engage.

Finally, the **treasure tables** were simplified and the amount of treasure is more generous than before.

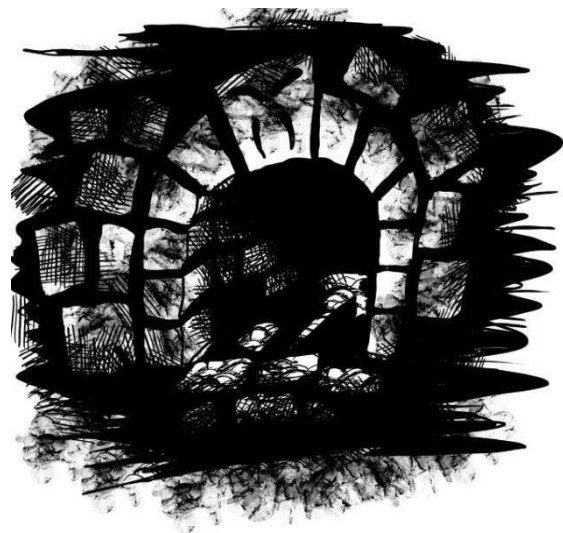

Appendix

A

Racial Classes

Some players like the idea of a character's race being their class. Of course, others do not, which is why the default in *Blood & Treasure* is to keep the two concepts separate.

For those who do like the idea of race-as-class, we present the following classes for Dwarves, Elves, Gnomes and Halflings.



The Dwarf

These doughty warriors come down from the hills and mountains to seek their fortune among the big folk.

Requirements & Restrictions

Dwarves must have the following minimum ability scores: Str 9, Con 9.

They can wear all armors and use any type of shield. They can wield any weapon in combat.

Dwarf Skills

Dwarves add their level to the following task checks:

Appraise—Dwarves can appraise the value of gems and art objects with a successful task check. They can also identify minerals and metals with this ability.

Repair—Dwarves can repair weapons and armor if they have a set of armorer's tools.

Dwarf Abilities

Dwarves enjoy a +3 bonus on saving throws against poison. They have a +3 bonus on saving throws against magic unless.

When underground, dwarves always note slanting and sloping passages, shifting walls, new construction and approximate depth underground.

Dwarves are +1 to attack goblins, hobgoblins and orcs, and have a +4 bonus to Armor Class against giants.

Dwarves can become steadfast in combat. While they are steadfast, they enjoy a +2 bonus on saving throws, a +2 bonus to AC, and they are immune to being knocked over or moved in combat. In addition, the steadfast dwarf can deflect missiles as a monk of equal level. While steadfast, the dwarf cannot move, for he must stand his ground.

A 9th level dwarf can retire to the hills or mountains and construct a dwarf hold. The dwarf hold is constructed underground, and includes a mine (roll randomly for the mine's contents using the table provided in the section on Strongholds and Domains).

Level	XP	HD	Attack	Save
1st	0	1d8	+1	16
2nd	2,000	2d8	+2	15
3rd	4,000	3d8	+3	15
4th	8,000	4d8	+4	14
5th	16,000	5d8	+5	14
6th	32,000	6d8	+5	13
7th	64,000	7d8	+6	13
8th	125,000	8d8	+7	12
9th	250,000	9d8	+8	12
10th	375,000	10d8	+9	11
11th	500,000	+3 hp	+10	11
12th	625,000	+3 hp	+10	10
13th	750,000	+3 hp	+11	10
14th	875,000	+3 hp	+12	9
15th	1,000,000	+3 hp	+13	9
16th	1,125,000	+3 hp	+14	8
17th	1,250,000	+3 hp	+15	7
18th	1,375,000	+3 hp	+15	7
19th	1,500,000	+3 hp	+16	7
20th	1,625,000	+3 hp	+17	7

The dwarf lord attracts 3d4x10 dwarf warriors and non-combatant dwarves equal to 200% of the warriors. One of every 10 warriors is a 1st level dwarf, and the warriors are led by a dwarf of level 4 to 7. These dwarves are all junior members of the dwarf's clan.

The Elf

An elf's martial and magical prowess is belied by their pleasant and flippant demeanor.

Requirements & Restrictions

Elves must have the following minimum ability scores: Str 9, Int 9.

They can wear leather and mail armors (though these interfere with their spellcasting) and use any type of shield. They can wield any weapon in combat.

Elf Skills

Elves add their level to the following task checks:

Lore—Elves can recall lore about magic items and monsters. A successful check reveals an item's powers and gives a clue to its command word, or reveals a monster's vulnerabilities.

Move Silently—Elves can walk slowly without making a sound if they are not in metal armor.

Elf Abilities

Elves have magic resistance 90% against sleep and charm, and they are immune to the paralyzing touch of ghouls. They find secret doors on a roll of 1-2 on 1d6. Elves are +1 to save vs. magic.

Elves enjoy a +1 bonus to attack when attacking with longbows, short bows, long swords and short swords.

Elves cast spells as a magic-user, using the same rules for preparing spells, keeping a spellbook and learning advanced spells. Elves cannot specialize in a particular school of magic.

An elf's spells per day per spell level is as a bard of equal level (see the bard's class advancement table).

Elves can wear armor while casting spells, but the armor creates a chance spell failure. When an elf casts a spell while wearing armor, they must roll 1d20 over their armor's base AC value. If they fail to do so, the spell is not cast successfully, and is lost from their memory.

At 10th level, an elf can construct a small castle which elven magic disguises as a natural hill. They usually construct their castles in deep woodlands, and elves never swear fealty to a human master.

The elf lord attracts 2d6x10 elf warriors and non-combatant elves equal to 200% of the warriors. One of every 10 warriors is a 1st level elf, and the warriors are led by an elf of level 4 to 7.

Level	XP	HD	Attack	Save
1st	0	1d6	+1	16
2nd	2,250	2d6	+2	15
3rd	4,500	3d6	+3	15
4th	9,000	4d6	+4	14
5th	18,000	5d6	+5	14
6th	36,000	6d6	+5	13
7th	72,000	7d6	+6	13
8th	140,000	8d6	+7	12
9th	280,000	9d6	+8	12
10th	420,000	10d6	+9	11
11th	560,000	+2 hp	+10	11
12th	700,000	+2 hp	+10	10
13th	840,000	+2 hp	+11	10
14th	980,000	+2 hp	+12	9
15th	1,120,000	+2 hp	+13	9
16th	1,260,000	+2 hp	+14	8
17th	1,400,000	+2 hp	+15	7
18th	1,540,000	+2 hp	+15	7
19th	1,680,000	+2 hp	+16	7
20th	1,820,000	+2 hp	+17	7



The Gnome

Gnomes adventure out of a sense of curiosity and a desire to see something new.

Requirements & Restrictions

Gnomes must have the following minimum ability scores: Int 9, Dex 9.

They cannot wear armor or use shields. They can wield all light weapons in combat.

Gnome Skills

Gnomes add their level to the following task checks:

Hear Noise—Gnomes can hear incredibly quiet noises through doors or from far away.

Move Silently—Gnomes can walk slowly without making a sound if they are not in metal armor.

Pick Pockets—Gnomes can pick pockets and perform small acts of legerdemain.

Taunt—Gnomes keep up the witty repartee while they are fighting, attacking with words as well as weapons. When an opponent misses them in combat, the gnome can attempt to task check to taunt them into becoming enraged and sloppy. With each success, the foe suffers a -2 penalty to Armor Class, but gains a +1 bonus to damage against the gnome when they hit in combat.

Tinker—A gnome can make a task check to fix metal tools and leather goods.

Gnome Abilities

Gnomes are +1 to save vs. magic and +3 to save vs. illusions.

Gnomes enjoy a +1 bonus to attack goblins and kobolds, and enjoy a +4 bonus to AC against giants.

When underground, gnomes always note sloping passages, unsafe construction, approximate depth underground and direction of travel.

Gnomes cast spells in the manner of magic-users, though using a different spell list (see below). They keep spell-books and prepare spells as a magic-user. Gnomes do not have basic and advanced spells.

Level	XP	HD	Attack	Save
1st	0	1d4	+0	15
2nd	1,750	2d4	+0	14
3rd	3,500	3d4	+1	14
4th	7,000	4d4	+1	14
5th	14,000	5d4	+1	13
6th	28,000	6d4	+2	13
7th	56,000	7d4	+2	12
8th	110,000	8d4	+3	12
9th	220,000	9d4	+3	12
10th	320,000	10d4	+3	11
11th	420,000	+1 hp	+4	11
12th	520,000	+1 hp	+4	11
13th	620,000	+1 hp	+5	10
14th	720,000	+1 hp	+5	10
15th	820,000	+1 hp	+5	10
16th	920,000	+1 hp	+6	9
17th	1,020,000	+1 hp	+6	9
18th	1,120,000	+1 hp	+7	9
19th	1,220,000	+1 hp	+7	8
20th	1,320,000	+1 hp	+7	8

Level	Spells per Day per Spell Level						
	1st	2nd	3rd	4th	5th	6th	7th
1st	2	-	-	-	-	-	-
2nd	3	-	-	-	-	-	-
3rd	3	1	-	-	-	-	-
4th	4	2	-	-	-	-	-
5th	4	2	1	-	-	-	-
6th	4	3	2	-	-	-	-
7th	5	3	2	1	-	-	-
8th	5	3	3	2	-	-	-
9th	5	4	3	2	1	-	-
10th	5	4	3	3	2	-	-
11th	5	4	4	3	2	1	-
12th	5	4	4	3	3	2	-
13th	5	4	4	4	3	2	1
14th	5	4	4	4	3	3	2
15th	5	4	4	4	4	3	2
16th	5	4	4	4	4	3	3
17th	5	4	4	4	4	4	3
18th	5	4	4	4	4	4	3
19th	5	4	4	4	4	4	4
20th	5	4	4	4	4	4	4



Gnomes attract random followers like bards. Beginning at 6th level, gnomes gain one follower per level until 12th level. Followers that are lost are not replaced.

d%	Follower
01-12	3 gnome warriors (leather, light crossbow, hand axe)
13-16	3 gnome warriors (chainmail, buckler, short sword)
17-46	Gnome bard (1st level)
47-56	Gnome druid (1st level)
57-81	Gnome fighter (1st level)
82-84	Gnome fighter/illusionist (1st level)
85-87	Gnome illusionist/thief (1st level)
88-92	Human or half-elf magic-user (1st level)
93-99	Human or half-elf thief (1st level)
00	Extraordinary follower

d%	Extraordinary Follower
01-30	Brownie
31-38	Giant badger
39-48	Blink dog
49-73	Raven
74-79	Gnome (i.e. this class; roll 1d3 for level)
80-85	Elf enchanter (1d3 for level)
86-00	Satyr

A 10th level gnome can create a gnome tower in the woods, fashioning it from an especially large oak using a ritual known only to the gnomes. The rooms inside the tree are 10' in diameter and fashioned entirely from the living wood of the tree. They constitute 10 stories, each with about 5' of headroom.

Gnome Spell List

1st level Spells

Audible Glamer	Change Self
Color Spray	Dancing Lights
Darkness	Detect Invisibility
Detect Magic	Hypnotism
Magic Aura	Obscuring Mist
Prestidigitation	Reflex Gaze
Light	Phantasmal Force I

2nd level Spells

Blindness/Deafness	Blur
Fog Cloud	Hypnotic Pattern
Invisibility	Magic Mouth
Mirror Image	Misdirection
Phantasmal Force II	Phantom Trap
Ventriloquism	

3rd level Spells

Continual Light	Darkness II
Dispel Magic	Displacement
Fear	Hallucinatory Terrain
Illusory Script	Invisibility Sphere
Nondetection	Rope Trick
Spectral Force	Suggestion

4th level Spells

Confusion	Creation I
Crushing Despair	Dispel Wounds
False Forest	Illusory Wall
Invisibility II	Phantasmal Killer
Rage	Rainbow Pattern
Shadow Conjuraction I	

5th level Spells

Bedlam	Cone of Paralysis
Creation II	Dream
False Vision	Maze
Mirage Arcana	Nightmare
Persistent Illusion	Seeming
Shadow Evocation I	Shadow Walk

6th level Spells

Mass Invisibility	Mass Suggestion
Mislead	Permanent Illusion
Programmed Illusion	Project Image
Shadow Conjuraction II	Simulacrum
True Sight	Veil

7th level Spells

Astral Projection	Limited Wish
Prismatic Spray	Prismatic Wall
Scintillating Pattern	Screen
Shades	Shadow Evocation II
Vision	Weird

The Halfling

Halflings are usually lured into adventure by a latent desire to see the world, and through the machinations of cunning old wizards and bands of dwarves.

Requirements & Restrictions

Halflings must have the following minimum ability scores: Con 9, Dex 9.

They can wear leather and mail armors and use bucklers. They can wield any weapon in combat.



Halfling Skills

Halflings add their level to the following task checks:

Cook—Halflings can make task checks to identify the ingredients in foods and drink, and they can appraise the value of food and drink.

Hide in Shadows—Halflings can disappear into the shadows and remain unseen, even while moving.

Move Silently—Halflings can walk slowly without making a sound if they are not in metal armor.

Pick Pockets—Halflings can pick pockets and perform small acts of legerdemain.

Halflings Abilities

Halflings enjoy a +1 bonus to attack when attacking with slings and thrown weapons. They surprise on a roll of 1-3 on 1d6 when alone and not wearing metal armor. Halflings have a +3 bonus to save vs. poison and magic.

When presented with a riddle or puzzle, a halfling player can attempt to roll 1d20 under their Wisdom score. If successful, the TK must give them a single clue. The halfling never gets more than one clue to a riddle or puzzle.

Halflings are natural storytellers. They can fascinate, as a bard, by spinning yarns. A halfling can tell a story for up to 30 minutes, or 1 hour if they have a pipe to smoke. A halfling cannot use the bard's *suggestion* power.

A 9th level halfling can construct a series of fortified burrows in a large, pleasant hill. The halfling sheriff attracts 3d4x10 halfling warriors. One of every 10 warriors is a 1st level halfling, and the warriors are led by a deputy halfling of level 4 to 7. These warriors bring their families (double the number of halfling warriors) to settle the new shire.

Level	XP	HD	Attack	Save
1st	0	1d8	+1	16
2nd	1,500	2d8	+2	15
3rd	3,000	3d8	+3	15
4th	6,000	4d8	+4	14
5th	12,000	5d8	+5	14
6th	24,000	6d8	+5	13
7th	48,000	7d8	+6	13
8th	100,000	8d8	+7	12
9th	200,000	9d8	+8	12
10th	300,000	10d8	+9	11
11th	400,000	+3 hp	+10	11
12th	500,000	+3 hp	+10	10
13th	600,000	+3 hp	+11	10
14th	700,000	+3 hp	+12	9
15th	800,000	+3 hp	+13	9
16th	900,000	+3 hp	+14	8
17th	1,000,000	+3 hp	+15	7
18th	1,100,000	+3 hp	+15	7
19th	1,200,000	+3 hp	+16	7
20th	1,300,000	+3 hp	+17	7

Appendix

D

Specialty Mages

The entry for the magic-user class includes mages that specialize in spells from different “schools” of magic. These specialists need not be the only specialist mages in your campaign. Using the same rules for specialists, you can devise different schools of magic in which to specialize.

What follows are two sample specialist mages. One of them is a staple of science fantasy stories, while the other is a bit

more whimsical, for those who like a little “gonzo” in their fantasy games.

The Mind Mage

The mind mage must have an intelligence score of 15 or higher. They apply their saving throw bonus to the spells below and basic spells that affect one’s mind.

Advanced Mind Spells

- 1 *Audible glamer, cause fear, feather fall, hypnotism, message, mind thrust, precognition*
- 2 *Brain lock, daze monster, ego whip, hypnotic pattern, know alignment, phantasmal force, thought shield*
- 3 *Mental barrier, psionic blast, rage, spectral force, suggestion*
- 4 *Choke, crushing despair, fear, illusory wall, intellect fortress, locate creature, mnemonic enhancer*
- 5 *Dominate person, dream, mind fog, mirage arcana, psychic crush, telepathic bond, tower of iron will*
- 6 *Density control, mass suggestion, probe thoughts*
- 7 *Ethereal jaunt, ultrablast, vision*
- 8 *Discern location, moment of prescience*
- 9 *Dominate monster, etherealness, foresight*

The Discomancer

The discomancer specializes in spells of light and sound, and a few “freak-out” spells as well. The discomancer must have a charisma score of 13 or higher.

You will note that the discomancer has fewer spells in her school than the mind mage. If you’re designing new spell schools, you might also need to invent some new spells to fill out the list, or find suitable spells in other spell lists or other sources entirely.

Advanced Discomancy Spells

- 1 *Audible glamer, color spray, dancing lights, hideous laughter, hypnotism, sound burst*
- 2 *Blur, darkness, glitterdust, hypnotic pattern, mirror image, shatter*
- 3 *Blink, daylight, displacement, suggestion*
- 4 *Rainbow pattern, phantasmal killer, shout*
- 5 *Bedlam, mind fog*
- 6 *Crystallize, eyebite, mass suggestion*
- 7 *Power word blind, prismatic spray*
- 8 *Irresistible dance, prismatic wall, scintillating pattern, sunburst*
- 9 *Freedom, wail of the banshee, weird*



Appendix

E

Spell Components

Treasure Keepers and players may find these lists of spell components and spell focuses a useful in play.

At a minimum, they may serve to remind players which gems and monster parts are valuable to spellcasters and worth keeping.

Spell	Components
<i>Binding</i>	Opals worth 500 gp per Hit Dice of target
<i>Commune</i>	Holy or unholy water and incense
<i>Consecrate</i>	Holy or unholy water and 5 lb of silver dust
<i>Contingency</i>	Vial of quicksilver, eyelash from an ogre mage or rakshasa (also has focus)
<i>Continual light</i>	50 gp of ruby dust sprinkled on the object to carry the light
<i>Divination</i>	Incense and sacrifice worth at least 25 gp
<i>False vision</i>	Jade dust worth 250 gp
<i>Find familiar</i>	Incense worth 100 gp
<i>Fire trap</i>	Sulfur and saltpeter
<i>Forbiddance</i>	Sprinkling of holy or unholy water, rare incense worth 3,000 gp
<i>Forcecage</i>	Ruby dust worth 1,500 gp
<i>Ghoul touch</i>	Pinch of earth from a ghoul's lair
<i>Glyph of warding</i>	You trace the glyph with incense, which must first be sprinkled with powdered diamond worth 200 gp
<i>Guards and wards</i>	Small silver rod, incense and a small amount of monster blood
<i>Hallow/Unhallow</i>	Herbs, oil and incense worth 1,000 gp + 1,000 gp/level of the spell to be included in the hallowed area
<i>Holy word/unholy word</i>	A tiny reliquary containing a sacred relic, such as the finger bone of a saint
<i>Identify</i>	Pearl worth 100 gp
<i>Illusory script</i>	Lead-based ink costing 50 gp
<i>Instant summons</i>	Sapphire worth 1,000 gp
<i>Legend lore</i>	Incense, four strips of ivory formed into a rectangle and one treasure must be sacrificed
<i>Mnemonic enhancer</i>	Ivory plaque worth 50 gp
<i>Nondetection</i>	Diamond dust (50 gp worth)
<i>Refuge</i>	Specially prepared object whose construction requires gems worth at least 1,500 gp.
<i>Resurrection</i>	Holy water
<i>Secret page</i>	Essence of will-o'-wisp
<i>Sepia snake sigil</i>	Amber powder (500 gp)
<i>Sequester</i>	Basilisk eyelash
<i>Simulacrum</i>	Pieces of the creature that is to be duplicated must be put into the snow or ice
<i>Soul Bind</i>	Black sapphire worth 1,000 gp per HD of creature whose soul is to be bound
<i>Stoneskin</i>	Diamond dust (250 gp)

Spell	Components
<i>Symbol of Death</i>	Mercury, phosphorous, diamond and opal dust worth 2,000 gp
<i>Symbol of Discord</i>	Mercury, phosphorous, diamond and opal dust worth 1,500 gp
<i>Symbol of Fear</i>	Mercury, phosphorous, diamond and opal dust worth 1,000 gp
<i>Symbol of Insanity</i>	Mercury, phosphorous, diamond and opal dust worth 1,500 gp
<i>Symbol of Pain</i>	Mercury, phosphorous, diamond and opal dust worth 750 gp
<i>Symbol of Persuasion</i>	Mercury, phosphorous, diamond and opal dust worth 1,000 gp
<i>Symbol of Sleep</i>	Mercury, phosphorous, diamond and opal dust worth 750 gp
<i>Symbol of Stunning</i>	Mercury, phosphorous, diamond and opal dust worth 1,500 gp
<i>Symbol of Weakness</i>	Mercury, phosphorous, diamond and opal dust worth 1,500 gp
<i>Sympathy</i>	Pearl dust worth 1,500 gp
<i>Teleportation circle</i>	Amber dust worth 1,000 gp
<i>Temporal stasis</i>	Diamond, emerald, ruby and sapphire dust worth a total of 5,000 gp
<i>True resurrection</i>	Holy water
<i>True seeing</i>	Ointment for the eyes composed of mushroom powder, saffron and fat aged for 1d6 months

Spell	Focus
<i>Analyze Dweomer</i>	Ruby or sapphire lens in a gold loop (1,500 gp)
<i>Augury</i>	Marked sticks, bones or cards
<i>Clone</i>	Vat and laboratory supplies
<i>Contingency</i>	Ivory statuette of you and 1,500 gp of gems
<i>Create undead</i>	Clay pot filled with grave dirt and another filled with brackish water. The spell must be cast on a dead body. You must place a black onyx gem worth at least 50 gp per HD of the undead to be created into the mouth or eye socket of each corpse. The magic of the spell turns these gems into worthless stones
<i>Crown of glory</i>	Crown worth at least 200 gp
<i>Dart of mistletoe</i>	Piece of Mistletoe dipped in 10 gp of gold
<i>Destruction</i>	Silver holy or unholy symbol inscribed with verses of anathema, costs 500 gp
<i>Mage's sword</i>	Miniature platinum sword with a grip and pommel of copper and zinc (250 gp to construct)
<i>Mathemagic principle</i>	Piece of slate worth 100 gp and three chalk sticks of different colors
<i>Protection from spells</i>	Diamond (1,000 gp) carried by each subject for the duration of the spell
<i>Scrying</i>	Magic-users need a finely wrought mirror worth 1,000 gp. Clerics need a holy water font worth 100 gp. Druids need a natural pool of water
<i>Shapechange</i>	Jade circlet (1,500 gp) worn on head
<i>Shield Other</i>	Two platinum rings (50 gp), worn by you and subject
<i>Trap the soul</i>	A gem worth 1,000 gp per Hit Dice/Level of the creature to be trapped

Appendix

F

Common Rolls and Useful Tables

The following is a reference guide to some of the more common dice rolls and most often used tables in the game.

Character Creation

1. Roll ability scores
2. Select race
3. Select class
4. Roll hit points
5. Roll heritage
6. Buy equipment
7. Choose alignment

Encounter Procedure

1. Reaction check
2. Surprise check
3. Roll initiative (if combat occurs)

Attack Roll Modifiers

Attack invisible creature	-4
Attack while invisible	+4
Attack parrying creature	+2
Backstab	+4
Charge damage	+2
Shooting beyond effective range	-4
Tactical advantage	+2
Tactical disadvantage	-2
Two-weapon fighting—primary weapon	-2
Two-weapon fighting—secondary weapon	-4

Illumination

Source	Illumination	Duration
Candle	5' radius	1 hour
Lamp	25' radius	6 hours/pint of oil
Lantern, bullseye	45' radius	6 hours/pint of oil
Lantern, hooded	90' cone	6 hours/pint of oil
Torch	30' radius	1 hour

Common Dice Rolls

Ability Check

Roll equal to or below ability score



Attack—Melee

Add attack bonus and strength modifier, beat AC



Attack—Ranged or Missile

Add attack bonus and dexterity modifier, beat AC



Attack—Combat Maneuver

Attack roll vs. AC 15; foe permitted saving throw



Evade Monsters

Success depends on speed



Falling Damage

1d6 per 10 feet, max. 10d6



Initiative Check

Highest roll goes first



Monster Hit Points

Always roll 1d6 per Hit Dice



Morale Check

A saving throw vs. fear



Reaction Check

Chance of hostility or friendliness varies



Saving Throw

Add relevant bonuses, beat Save value



Surprise Check

Surprised on 1, 1-2 or 1-3; varies with creature



Task Check

Add relevant ability bonus, beat '18'



Turn Undead Check

Add relevant ability bonus, beat '18'



Index

Ability scores	2	Chaos Mage	42
Generating	2	Character, Non-Player (NPC)	2
Modifiers	3	Character, Player (PC)	2
Acid	57	Charisma	4
Acrobat	43	Class	2, 8
Acrobatics (task)	24, 32	Cleric	8, 15
Adamantine	57	Specialty priests	16
Adept (NPC)	60	Spell list	18-19
Age, effects of	7	Climb walls (task)	9, 11, 13, 32, 42
Alchemist	58	Comatose	63
Alchemist's fire	57	Combat	66
Alchemy (task)	28, 39	Actions	67
Alignment	2, 45	Charging	68
Alignment languages	46	Fighting defensively	68
Animal trainer	58	Initiative	66
Antipaladin	37	Melee attacks	67
Antitoxin	57	Morale checks	67
Arcane knowledge (magic-user)	29	Mounted combat	68
Armor Class	2, 53	Ranged attacks	67
Armor and shields	53, 54	Special maneuvers	68
Magic armor	194	Tactical advantage	67
Armorer	58	Two-weapon fighting	68
Artisan	47, 58	Underwater combat	68
Assassin class	8, 9	Combat, Mass	74
Attack bonus	2	Combat, Naval	77
Backstab	9, 43, 68	Conditions	63
Badges (paladin)	35	Constitution	4
Barbarian class	8, 11	Conversion, game	
Bard class	8, 13	First to second edition	249
Bearer	58	Other systems	250
Beastmaster	12	Conversion (task)	15
Blinded	63	Counter-spells	82
Bounty hunter	10	Crippled	63
Bowyer	59	Critical fumbles (optional)	67
Caltrops	57	Critical hits (optional)	67
Carouse	13	Cursed items	191, 235
Cavalier	27	Damage	67, 69
Change shape (druid ability)	21	Ability damage and drain	70
Chaos/Chaotic (alignment)	46	Energy damage and drain	70

Dazed	63	Find/remove traps	42
Deafened	63	Forgery	9
Defender	27	Frightened	63
Dexterity	4	Gems	189
Discomancer (specialist mage)	256	Gnome (race)	6
Disease	64	Gnome (class)	253
Disguise	9	Grievous wounds	70
Dragon hide	57	Half-elf	7
Druid	8, 20	Halfling (race)	7
Spell list	22-23	Halfling (class)	254
Dual-class	44	Half-orc	7
Duelist	8, 24	Handle animal (task)	37
Dungeons	160	Healing	71
Mapping	160	Healing (task)	15, 20
Random	163	Hear noise (task)	9, 11, 13, 32, 37, 42
Dwarf (race)	6	Henchmen	57
Dwarf (class)	251	Finding and hiring	57
Elf (race)	6	Heritage	46
Elf (class)	252	Hide in shadows (task)	9, 11, 13, 32, 42
Encounters	66	Hirelings	57
Encumbrance	61	Finding and hiring	57
Engineer	59	Hit Dice	2
Entangled	63	Class	8
Equipment	48	Hit points	2
Alchemical items	55, 57	Holy/unholy water	57
Clothing	56	Horde (barbarian)	12
Food and lodging	56	Human	4
Livestock	56	Hunting beast (ranger follower)	38
Other equipment	55	Impromptu casting (sorcerer)	40
Services	56	Initiative	66
Tools	55	Intelligence	3
Transportation	56	Invisibility	68, 116
Evading monsters	64	Jester	14
Example of play	78	Jeweler	59
Experience points (XP)	2	Lackey (duelist servant)	24
Earning XP	8	Languages	3, 6
Falling	64	Law/Lawful alignment	45
Fascinate (bard ability)	13	Lay on hands (paladin ability)	35
Fatigued	63	Level	2
Feat	2, 44	Advancing in level	8
Fighter class	8, 26	Light	62
Fighting defensively	68	Lore	13, 20, 28

Mad	63	Oil	57
Magic items	190	Oil (magic item)	201
Armor	194	Open locks (task)	9, 13, 32, 42
Charges, doses, etc.	191	Paladin	8, 35
Creating	191	Code	36
Cursed	191, 235	Warhorse/war pony	36
Intelligent weapons	191, 200	Paralyzed	63
Potions and oils	201	Parry (duelist ability)	24
Rings of power	202	Petrified	63
Rods	205	Pick pockets (task)	13, 42
Science	244	Planes	181
Scrolls	81, 209	Poison	65
Staves	210	Brewing	9-10
Wands	211	Potion (magic item)	201
Weapons	196	Priest	59
Wondrous Items	212	Prone	63
Magic Resistance	82	Prophet	42
Magic-user	8, 28	Quivering palm (monk ability)	33
Specialist mages	29	Race, fantasy	2, 4
Spell list	30-32	Rage (barbarian ability)	11
Man-at-arms	59	Random encounters	
Mariner	39	Settlements	177
Marksman	25	Wilderness	171
Mass combat	74	Range (for weapons)	51
Material weights	168	Ranged attacks	67
Melee attacks	67	Ranger	8, 37
Mind mage (specialist mage)	256	Reactions	66
Mithral	57	Read languages (task)	9, 13, 32, 42
Molds	166	Riding (task)	26, 35
Money	48	Ring (magic item)	202
Monk	8, 33	Riposte (duelist ability)	24
Morale checks	67	Rod (magic item)	205
Move silently (task)	9, 11, 13, 32, 37, 42	Rogue	60
Movement		Ronin	34
Dungeon	61	Rules of play	61
Exploration speed	61	Running a game	158
Water	62	Sacrifice (druid ability)	21
Wilderness	61	Sage	60
Multi-class	44	Saving throw	2, 63, 82
Naval combat	77	Item saving throw	63
Neutral (alignment)	45	Science (magic items)	244
Ninja	34	Scout	43

Scroll (magic item)	210	Building costs	72
Sea dog	25	Stunned	63
Selling loot	48	Surprise	66
Sense vibrations (sorcerer ability)	39	Survival (task)	11, 37
Sergeant	59	Swimming	65
Set snares (task)	37	Tactical advantage	67
Settlements	173	Task check	2, 65
Law enforcement	177	Simple task checks	66
Random settlements	179	Taunt	24
Social classes	175	Taxes	73
Warfare	177	Terrain	171
Sickened	63	Thief	8, 42
Shaman	22	Thirst	64
Ships	62, 77	Time	61
Siege Engines	76	Tracking	11, 37
Silver (special material)	57	Trade goods	48
Skill Points (optional)	65, 66	Traps	167
Slimes	166	Treasure	190
Sorcerer	8, 39	Art objects	190
Bloodlines	41	Coins	189
Spells known	40	Gems	189
Spell list		Random tables	189
Adept (NPC)	60	Treasure Keeper	2
Cleric	18-19	Turn undead	16, 35, 69
Druid	22-23	Wand (magic item)	211
Magic-user	30-32	Wandering monsters	169
Spells	81	Warlock	42
Advanced spells	81	Weapons	48
Casting	82	Ammunition	53
Components	82, 257	Magic	196
Cost of casting	81	Melee weapons—heavy	51
Counter-spells	82	Melee weapons—light	49
Creating	81	Melee weapons—medium	50
Descriptions	83	Ranged weapons	51, 52
Dismissing	82	Wild magic (table)	184
Preparing	81	Wilderness	170
Researching	81	Random wilderness	172
Spellbooks and scrolls	81	Wisdom	3
Staff (magic item)	210	Wizard-hunter	39
Starvation	64	Wondrous item (magic item)	212
Strength	3	Wondrous mount (fighter ability)	26
Strongholds and domains	71		

Blood & Treasure

CHARACTER RECORD SHEET

Character's Name _____ Race _____

Class _____ Level _____

Alignment _____ XP _____

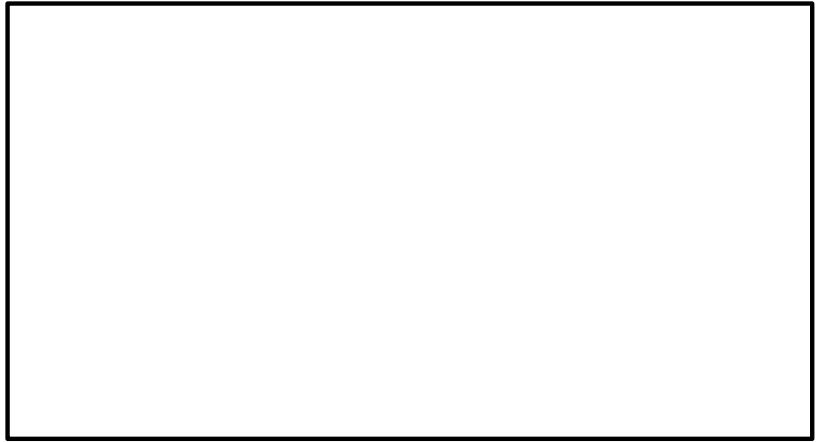

Character Sketch or Symbol

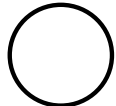

Armor Class

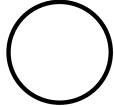

Attack Bonus

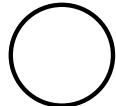

Hit Points

ABILITIES

Strength

_____ modifier _____ carry capacity

Intelligence

_____ modifier _____ languages

Wisdom

_____ modifier

Dexterity

_____ modifier

Constitution

_____ modifier

Charisma

_____ modifier _____ followers

Heritage

_____ secondary skill

Saving Throw

_____ saving throw bonuses

WEAPONS

Weapon	Atk Bonus	Dmg	Eff. Rng.	Max. Rng.
_____	_____	_____	_____	_____

OTHER EQUIPMENT



SPECIAL ABILITIES, SKILLS & FEATS



Weight Carried:

Movement Rate:

COINS

PP:
GP:
EP:
SP:
CP:

TREASURE



Designation of Product Identity: The following items are hereby designated as Product Identity in accordance with Section 1(e) of the Open Game License, version 1.0a: Any and all logos and identifying marks and trade press, such as all John M. Stater product and product line names including but not limited to *1800 – American Empires™*, *Action X™*, *Blood & Treasure™*, *Blood & Treasure 2nd Edition™*, *Bloody Basic™*, *GRIT & VIGOR™*, *Mystery Men!*, *NOD™*, *LAND OF NOD™*, *PARS FORTUNA™*, *Queen & Kaiser™*, *Space Princess™*; any specific characters and places; capitalized names and original names of places, artifacts, characters, races, countries, geographic locations, gods, historic events, and organizations; any and all stories, storylines, histories, plots, thematic elements, and dialogue; and all artwork, symbols, designs, depictions, illustrations, maps, and cartography, likenesses, poses, logos, or graphic designs, except such items that are in the public domain or used via a Creative Commons license (and edition). The above Product Identity is not Open Game Content.

Designation of Open Game Content: Subject to the Product Identity designation above, all portions of *Blood & Treasure – Players Tome* are designated as Open Game Content.

OPEN GAME LICENSE Version 1.0a

The following text is the property of Wizards of the Coast, Inc. and is Copyright 2000 Wizards of the Coast, Inc ("Wizards"). All Rights Reserved.

Definitions: (a) "Contributors" means the copyright and/or trademark owners who have contributed Open Game Content; (b) "Derivative Material" means copyrighted material including derivative works and translations (including into other computer languages), potation, modification, correction, addition, extension, upgrade, improvement, compilation, abridgment or other form in which an existing work may be recast, transformed or adapted; (c) "Distribute" means to reproduce, license, rent, lease, sell, broadcast, publicly display, transmit or otherwise distribute; (d) "Open Game Content" means the game mechanic and includes the methods, procedures, processes and routines to the extent such content does not embody the Product Identity and is an enhancement over the prior art and any additional content clearly identified as Open Game Content by the Contributor, and means any work covered by this License, including translations and derivative works under copyright law, but specifically excludes Product Identity. (e) "Product Identity" means product and product line names, logos and identifying marks including trade dress; artifacts; creatures characters; stories, storylines, plots, thematic elements, dialogue, incidents, language, artwork, symbols, designs, depictions, likenesses, formats, poses, concepts, themes and graphic, photographic and other visual or audio representations; names and descriptions of characters, spells, enchantments, personalities, teams, personas, likenesses and special abilities; places, locations, environments, creatures, equipment, magical or supernatural abilities or effects, logos, symbols, or graphic designs; and any other trademark or registered trademark clearly identified as Product Identity by the owner of the Product Identity, and which specifically excludes the Open Game Content; (f) "Trademark" means the logos, names, mark, sign, motto, designs that are used by a Contributor to identify itself or its products or the associated products contributed to the Open Game License by the Contributor (g) "Use", "Used" or "Using" means to use, Distribute, copy, edit, format, modify, translate and otherwise create Derivative Material of Open Game Content. (h) "You" or "Your" means the licensee in terms of this agreement.

The License: This License applies to any Open Game Content that contains a notice indicating that the Open Game Content may only be Used under and in terms of this License. You must affix such a notice to any Open Game Content that you Use. No terms may be added to or subtracted from this License except as described by the License itself. No other terms or conditions may be applied to any Open Game Content distributed using this License.

Offer and Acceptance: By Using the Open Game Content You indicate Your acceptance of the terms of this License.

Grant and Consideration: In consideration for agreeing to use this License, the Contributors grant You a perpetual, worldwide, royalty-free, non-exclusive license with the exact terms of this License to Use, the Open Game Content.

Representation of Authority to Contribute: If You are contributing original material as Open Game Content, You represent that Your Contributions are Your original creation and/or You have sufficient rights to grant the rights conveyed by this License.

Notice of License Copyright: You must update the COPYRIGHT NOTICE portion of this License to include the exact text of the COPYRIGHT NOTICE of any Open Game Content You are copying, modifying or distributing, and You must add the title, the copyright date, and the copyright holder's name to the COPYRIGHT NOTICE of any original Open Game Content you Distribute.

Use of Product Identity: You agree not to Use any Product Identity, including as an indication as to compatibility, except as expressly licensed in another, independent Agreement with the owner of each element of that Product Identity. You agree not to indicate compatibility or co-adaptability with any Trademark or Registered Trademark in conjunction with a work containing Open Game Content except as expressly licensed in another, independent Agreement with the owner of such Trademark or Registered Trademark. The use of any Product Identity in Open Game Content does not constitute a challenge to the ownership of that Product Identity. The owner of any Product Identity used in Open Game Content shall retain all rights, title and interest in and to that Product Identity.

Identification: If you distribute Open Game Content You must clearly indicate which portions of the work that you are distributing are Open Game Content.

Updating the License: Wizards or its designated Agents may publish updated versions of this License. You may use any authorized version of this License to copy, modify and distribute any Open Game Content originally distributed under any version of this License.

Copy of this License: You MUST include a copy of this License with every copy of the Open Game Content You Distribute.

Use of Contributor Credits: You may not market or advertise the Open Game Content using the name of any Contributor unless You have written permission from the Contributor to do so.

Inability to Comply: If it is impossible for You to comply with any of the terms of this License with respect to some or all of the Open Game Content due to statute, judicial order, or governmental regulation then You may not Use any Open Game Material so affected.

Termination: This License will terminate automatically if You fail to comply with all terms herein and fail to cure such breach within 30 days of becoming aware of the breach. All sublicenses shall survive the termination of this License.

Reformation: If any provision of this License is held to be unenforceable, such provision shall be reformed only to the extent necessary to make it enforceable.

COPYRIGHT NOTICE

Open Game License v 1.0a Copyright 2000, Wizards of the Coast, Inc.

System Reference Document Copyright 2000-2003, Wizards of the Coast, Inc.; Authors Jonathan Tweet, Monte Cook, Skip Williams, Rich Baker, Andy Collins, David Noonan, Rich Redman, Bruce R. Cordell, John D. Rateliff, Thomas Reid, James Wyatt, based on original material by E. Gary Gygax and Dave Arneson.

Blood & Treasure 2nd Edition Rulebook, Copyright 2016, John M. Stater. Author: John M. Stater.

Basic Fantasy Role-Playing Game Copyright © 2006-2008 Chris Gonnerman.

Castles & Crusades: Players Handbook, Copyright 2004, Troll Lord Games; Authors Davis Chenault and Mac Golden

Labyrinth Lord™ Copyright 2007, Daniel Proctor. Author Daniel Proctor.

Land of Nod, Copyright 2010, 2011, 2012, 2013, 2014, 2015, John M. Stater; Author John M. Stater

OSRIC copyright 2006-08 by Stuart Marshall, adapting material prepared by Matthew J. Finch, based on the System Reference Document, inspired by the works of E. Gary Gygax, Dave Arneson, and many others.

The Grand OGL Wiki, <http://grandwiki.wikidot.com> Copyright 2008-2009 Purple Duck Creations; Authors: Mark Gedak, Alex Schroeder, Joel Arellano, George Fields, Yair Rezek, Mike Whalen, Shane O'Connor, Mike Rickard, John Whamond, Bill Browne, Eric Williamson, Slatz Grubnik, Charles R. Wenzler Jr, John Fraser.

Open game content from **Epic Player's Guide – Renegade Cleric's Tome** is copyright 2006, Mongoose Publishing Ltd.

Open game content from **Epic Player's Guide - Renegade Wizard's Spellbook** is copyright 2005, Mongoose Publishing Ltd.

101 1st Level Spells. Copyright 2011, Steven D. Russell; Author: Steven D. Russell.

Spells & Magic Copyright 2002, Bastion Press, Inc.

END OF LICENSE

A Complete Fantasy Game



Rules Light - Options Heavy

Play your game your way

- A plethora of character classes
- All the classic fantasy races
- Hundreds of spells
- Hundreds of monsters in the companion volume
- Advice on running and designing adventures