

PALLADIUM BOOKS® PRESENTS . . .

# BEYOND THE SUPERNATURAL™

By Randy McCall &  
Kevin Siembieda

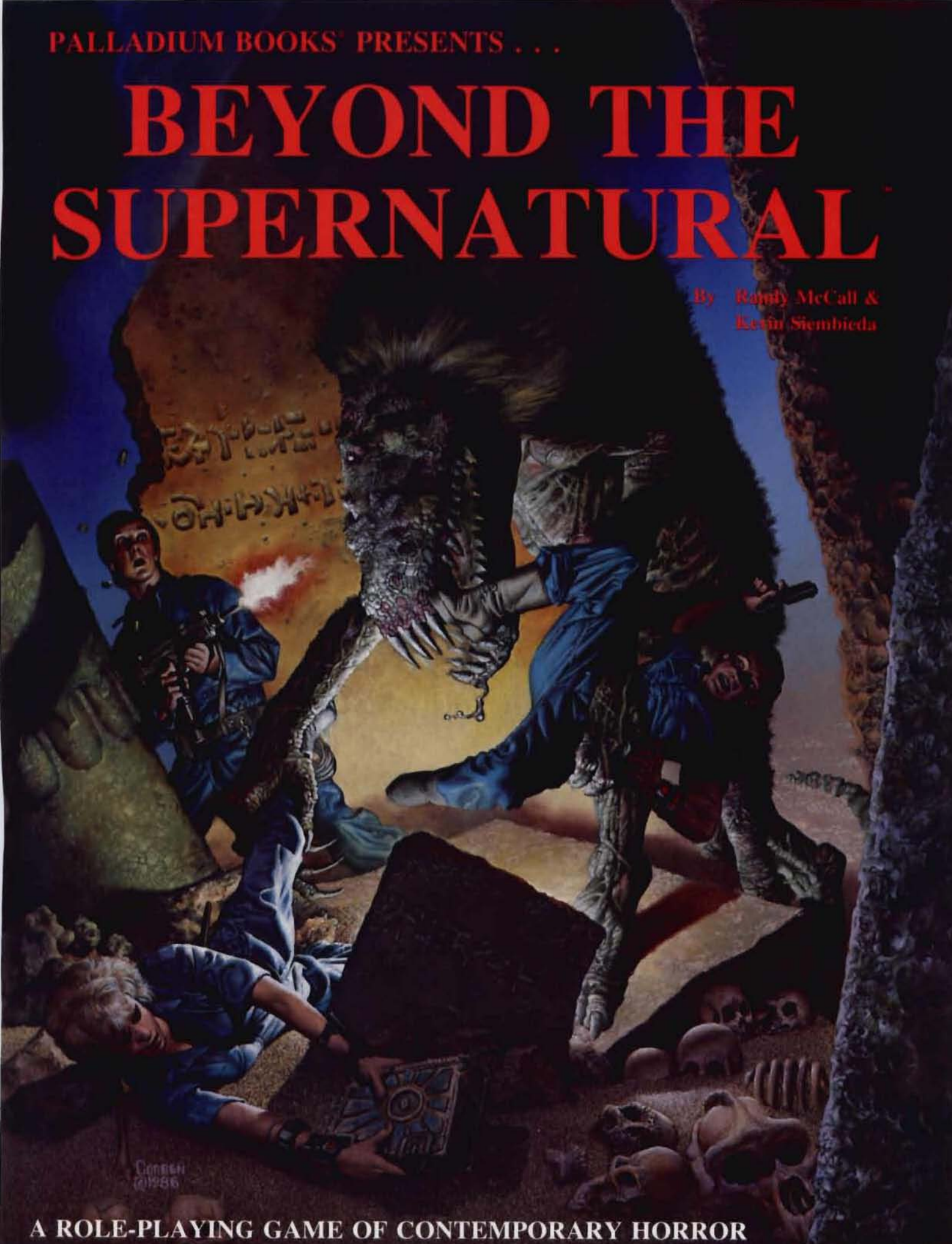

©1986  
Palladium Books

A ROLE-PLAYING GAME OF CONTEMPORARY HORROR

## **WARNING!**

This game may contain subject matter, the supernatural, psychic powers, magic and monsters, which *may* not be appropriate for young readers.

The context of this *Role-Playing Game* book is fictional; make-believe. However, its detail and realistic portrayals may offend some and disturb others. Please NOTE that none of us at Palladium Books® condone nor encourage the occult or the use of magic.



**This Book is Dedicated to Our Loving Parents.**

**Fifth Printing — June 1993**

**Copyright © 1988 by Kevin Siembieda.**

Cover Art Copyright © 1986 Richard Corben.

Back Cover Art Copyright © 1988 Steven R. Bissette.

Copyright © 1988 by Kevin Siembieda. All rights reserved under the Universal Copyright Convention. No part of this book may be reproduced in part or whole, in any form or by any means, without permission from the publisher, except for brief quotes for use in reviews. All incidents, situations, institutions, governments and people are fictional and any similarity, without satiric intent, of characters or persons living or dead is strictly coincidental.

**Palladium Books** and **Megaverse** are registered trademarks owned and licensed by Kevin Siembieda.

**Beyond the Supernatural** is published by Palladium Books Inc., 12455 Universal Drive, Taylor, MI 48180.

Printed in the United States of America.

PALLADIUM BOOKS® PRESENTS . . .

# BEYOND THE SUPERNATURAL™

Written By: **Randy McCall**  
**Kevin Siembieda**

Victim Rules & Additional Text: **Erick Wujcik**

Editors: **Alex Marciniszyn**  
**Florence Siembieda**

Cover Art: **Richard Corben**

Back Cover: **Steven R. Bissette**

Interior Art: **Steven R. Bissette**  
**Kevin Long**

Art Direction: **Kevin Siembieda**  
Typography: **Maryann Siembieda**  
Keylining: **Matthew Balent**  
**Maryann Siembieda**

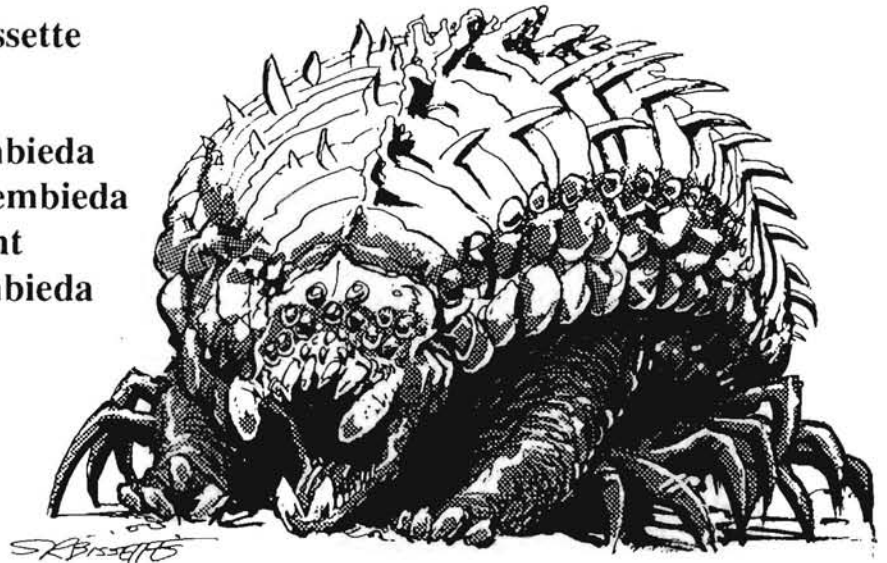

**Special Thanks To:** Randy, Thom, Steve, Erick, Kevin, Rick, Maryann,  
Alex, Jeff and the folks at Gateways Magazine.



# TABLE OF CONTENTS

	<b>Page</b>
How To Play . . . . .	7
Glossary of Terms . . . . .	8
Creating A Character . . . . .	9
Step One: The Eight Attributes . . . . .	9
Attribute Bonuses . . . . .	9
Step Two: Hit Points & S.D.C. . . . .	10
Recovery Of Hit Points . . . . .	11
Surviving Coma and Death . . . . .	11
Optional Damage Rules . . . . .	12
Step Three: Selecting a Psychic Character Class . . . . .	13
Step Four: Occupation . . . . .	14
Step Five: Education and Skills . . . . .	15
Step Six: Equipment and Money . . . . .	15
Step Seven: Rounding Out One's Character . . . . .	16
Alignments . . . . .	16
Experience Points . . . . .	18
Experience Level Tables . . . . .	20
Insanity . . . . .	21
Optional Ways to Round Out Your Character . . . . .	24
Character Background . . . . .	25
Selecting Education and Skills . . . . .	27
Education Levels . . . . .	27
Skill Programs . . . . .	27
Available Skill Programs . . . . .	28
Skill Notes . . . . .	28
Secondary Skills . . . . .	29
Skill Descriptions . . . . .	32
Modern Weapon Proficiencies . . . . .	41
Hand to Hand Combat . . . . .	43
Combat Terms . . . . .	43
Hand to Hand Combat Skill Abilities . . . . .	45
Psychic Combat . . . . .	46
Saving Throws . . . . .	46
Horror Factor . . . . .	47
Psychic Character Classes . . . . .	48
A Summary of the Nine Psychic Character Classes . . . . .	48
Potential Psychic Energy . . . . .	49
The Arcanist . . . . .	50
The Latent Psychic . . . . .	53
The Natural or Genius . . . . .	55
Electrical Genius . . . . .	55
Computer Hacker . . . . .	56
Human Calculator . . . . .	57
Weapons Expert . . . . .	57
Bio-Feed Back . . . . .	58
Exceptional Physical Prowess . . . . .	58
Exceptional Physical Strength . . . . .	59
The Nega Psychic . . . . .	59
The Parapsychologist . . . . .	61
Special Equipment . . . . .	63
Optional Background Tables . . . . .	64
The Physical Psychic . . . . .	65

	<b>Page</b>
The Psi Mechanic . . . . .	67
The Psychic Healer . . . . .	69
Special Abilities . . . . .	70
The Psychic Sensative . . . . .	72
Ordinary People (Optional) . . . . .	74
Animals . . . . .	75
Descriptions of the Psychic Abilities . . . . .	76
Psychic Healer Abilities . . . . .	76
Physical Psychic Abilities . . . . .	78
Psychic Sensitive Abilities . . . . .	83
The Secrets of Magic . . . . .	92
Step One: Belief . . . . .	92
Step Two: Mental Discipline . . . . .	92
Step Three: Understanding Magic . . . . .	93
Step Four: Understanding P.P.E. and Magic . . . . .	93
Drawing P.P.E. From Others . . . . .	94
Recovery of P.P.E. . . . .	95
Step Five: Spells, Rituals and Summoning . . . . .	95
Step Six: The Pursuit of Magic . . . . .	97
Determining Mystic Knowledge . . . . .	98
Initial Knowledge of the Arcanist . . . . .	99
Magic Invocations: Spells and Rituals . . . . .	100
Levels of Magic . . . . .	100
Spells or Rituals . . . . .	100
Magic Combat . . . . .	100
Magic . . . . .	101
Alphabetical List of Invocations . . . . .	102
Invocation Descriptions . . . . .	103
Ley Lines and Places of Magic . . . . .	128
A Doorway to Unreality . . . . .	130
The Essence of Magic . . . . .	130
Places of Power . . . . .	131
Ley Lines . . . . .	131
Ley Line Nexus Points . . . . .	135
Rips of Magic . . . . .	132
Transitional Places of Power . . . . .	135
P.P.E. Power Tables . . . . .	136
Power Triads . . . . .	136
Random Encounter Table . . . . .	138
G.M.'s Option . . . . .	140
Prolonged Exposure to Places of Power . . . . .	141
The Cure . . . . .	142
Places of Power Around the Globe . . . . .	143
British Isles . . . . .	143
North America . . . . .	149
The Pyramids . . . . .	150
The Monster Section . . . . .	153
Greater Beings . . . . .	176
Monster Related Items . . . . .	189
The Evil Arcanist Quick Roll Villain . . . . .	189
Random Creature Creation Tables . . . . .	190
Possession . . . . .	192



	<b>Page</b>
Game Master's Section . . . . .	193
Role Playing the Victim Character . . . . .	193
Generating the Victim . . . . .	194
Attribute Roll Up Table . . . . .	194
Financial Background . . . . .	195
Skills . . . . .	195
Experience and Equipment . . . . .	196
Victims: Guide for the Game Master . . . . .	196
A Game Master's Guide to Playing the Supernatural . . . . .	197
The Rules of Horror . . . . .	197
Beyond the Rules . . . . .	198
Horror in the G.M.s Voice . . . . .	198
Guidelines For Scenario Generation . . . . .	199
Miscellaneous Non-Player Characters . . . . .	201
Adventures . . . . .	205
Teeny-Bopper Terror . . . . .	205
The Randolph Family Mansion . . . . .	211
A Window on the World . . . . .	218
City Ruins . . . . .	223
Weapons and Equipment . . . . .	225

### A Quick Find Reference Table

Attribute Bonuses . . . . .	9	Level Six Magic . . . . .	110
Determining Hit Points . . . . .	10	Level Seven Magic . . . . .	112
Determining S.D.C. . . . .	10	Level Eight Magic . . . . .	115
Insanity . . . . .	24	Level Nine Magic . . . . .	117
Available Skill Programs . . . . .	28	Level Ten Magic . . . . .	119
Hand to Hand Combat Skills . . . . .	45	Level Eleven Magic . . . . .	121
Psychic Combat . . . . .	46	Level Twelve Magic . . . . .	122
Horror Factor . . . . .	47	Level Thirteen Magic . . . . .	124
Arcanist . . . . .	50	Level Fourteen Magic . . . . .	125
Latent Psychic . . . . .	53	Level Fifteen Magic . . . . .	126
Natural/Genius . . . . .	55	Ley Lines . . . . .	130
Nega Psychic . . . . .	59	Summary of Ley Line Nexus Energy Peaks . . . . .	135
Parapsychologist . . . . .	61	Power Triads . . . . .	136
Physical Psychic . . . . .	65	Power Triad Encounters . . . . .	138
Psi-Mechanic . . . . .	67	Negative Effects of Ley Lines . . . . .	141
Psychic Healer . . . . .	69	Stonehenge . . . . .	143
Psychic Sensitive . . . . .	72	Maes Howe . . . . .	146
Psychic Healer Abilities . . . . .	76	Indian Mounds . . . . .	149
Physical Psychic Abilities . . . . .	78	Pyramids . . . . .	150
Psychic Sensitive Abilities . . . . .	83	Places of Power Map . . . . .	152
The Secrets of Magic . . . . .	92	Monsters . . . . .	153
Drawing P.P.E. From Others . . . . .	94	Entities . . . . .	159
Recovery of P.P.E. . . . .	95	Greater Beings . . . . .	176
Cults . . . . .	95	Vampires . . . . .	181
Determining Mystic Knowledge . . . . .	98	Intelligences . . . . .	185
Arcanist's Initial Knowledge . . . . .	99	Evil Arcanist . . . . .	189
Magic Combat . . . . .	100	Random Monster Tables . . . . .	190
Magic Invocations List . . . . .	102	Possession . . . . .	192
Level One Magic . . . . .	103	Victim Role-Playing . . . . .	193
Level Two Magic . . . . .	104	Victor Lazlo . . . . .	204
Level Three Magic . . . . .	105	Weapons & Equipment . . . . .	225
Level Four Magic . . . . .	107		
Level Five Magic . . . . .	109		



## WHAT IS REAL?

Over the years there has been a controversy that some people who play role-playing games can not tell what is real and what is fantasy. The conjecture is that the person can lose himself in the fantasy world. With this in mind, I would like to define, right now, what is real and what is *not*.

This book is fiction! Make believe. None of it is real! Like any good fiction, we have tried to make an imaginary world seem believable. It is a turbulent, exciting world of mystery, adventure, strange powers and inhuman monsters. It is the stuff of all great tales, from Homer's Iliad to Steven Spielberg's movie, Poltergeist. To capture the illusion of reality, of plausibility, we have alluded to science, technology and real places of mystery like Stonehenge and the Bermuda Triangle. We have weaved a fascinating tale of supernatural forces and mystery around these places, but none of it is real. It might sound convincing, perhaps even plausible, for a moment, but it is not true. It is outlandish nonsense that is fun to tantalize your imagination. Take the Bermuda Triangle for example. People like to scare themselves with weird stories and the unexplainable. We've taken that aura of mystery and have made it a part of our fictional world. We propose that the Bermuda Triangle may be a dimensional gateway. A focal point for supernatural entities. Scary, mysterious, intriguing. Now stop and think about this for a minute. The Bermuda Triangle covers several of the most popular and visited vacation spots in the world. This proposed hotbed of the supernatural includes the waters and islands of Fort Lauderdale, Miami Beach, the Bahamas, West Indies, Puerto Rico and Bermuda. This is a vacation heaven. Somehow I think people would notice if vacationing executives and honeymooners suddenly began to disappear on a regular basis. However, it's fun to *pretend* that there might be some insidious force lurking in those waters. Silly? Maybe. But why not?

The same holds true of the other things presented in this book, like psychic powers, magic, and monsters. You might recognize a name like telepathy, or voodoo or vampire, but the descriptions in this book are complete malarky. None of it is real. We have not published any secret rituals, or magic spells, text or runes. None of it can be made to happen in the *real* world. It is *not* real. Professor Victor Lazlo is not real. Nor is he a composite of real people. The extensively quoted books of Victor Lazlo do *not* exist either. The theories behind ghosts, entities, focus, psychic powers, magic, supernatural forces, creatures, ley lines, geomancy, and all the rest, are *not* real. We made it all up. It is fiction which wildly extrapolates and combines myths, legends, superstitions and reports of unexplained phenomena. Add a little touch of science, a dab of science fiction, a pinch of the omnicus, a smidgen of horror, and sprinkle a serious tone over it all . . . and . . . voilà! You have **Beyond the Supernatural**. A game that offers you a world of adventure and mystery.

Beyond the Supernatural is a game. It is meant to be fun. A brief respite from the ordinary, humdrum routine of daily life. It is a fanciful entertainment that lets its players build a story around *characters* they have created. An elaborate version of cops and robbers. Role-playing should be like playing Monopoly or Yatzee; a gathering of friends to share a few laughs, devour some munchies, guzzle soft drinks, and have a good time playing. That's right. Teens and/or grown men and women sitting around,

playing a game. What a concept! If you find yourself turning out lights and lighting candles, wearing a robe, casting spells or seeing spirits, toss this book out the window and talk to somebody quick. Talk to your Mom or Dad, a friend, a priest, a psychologist or someone who cares, because this isn't normal. Remember, it's just a **game**.

## HOW TO PLAY A ROLE-PLAYING GAME

Role-playing games are really just an advanced form of regular board games. In fact, they are so advanced that they no longer use a board. Some of the elements are still the same; you still need paper and pencil, dice and players. But the main thing you need to play a role-playing game is IMAGINATION.

### Let's Take It A Step At A Time.

#### Imagine the Scene

Picture a basement: There is an open step staircase leading down. The walls are covered in an age tarnished, white paint, with large cracks, chips and blotches revealing the red brick underneath. If you turn to look directly opposite from the stairs, the whole basement lies before you. An automatic washing machine and dryer are along the left wall, with water hoses connecting the washer to the large laundry tub and sink next to it. Directly across from the appliances looms the huge iron belly of the gas furnace; its large, old-style heating pipe weaving across the ceiling/floor like tentacles. Storage boxes, old newspapers, rags and dust covered jars, lean against the walls in scattered stacks. In the far wall is a small pantry, a tool shed/workroom and a large old coalbin. A glance at the solid, glass block windows that rim the right and left walls shows that it's getting dark outside.

Can you picture this scene? Try to keep the mental image in your head. Don't worry if you forget the details; one of the great things about role-playing is the way your memory is improved with practice. Now you are ready for the next step . . .

#### Imagine the Setting

A foul odor is mingled with the musty basement air. The coalbin door, which is always kept locked, yawns a foot and a half open. Beyond the door is only blackness. Suddenly, a hoarse, inhuman chuckling begins to rise from below the steps.

Like a cameraman in a film, the scene is established, and now our attention is focused to a specific setting, the stairs. We have also established an atmosphere and the beginning of action. Got all that? Good. Now let's figure out where you, the player, fit into this.

#### Imagine the Character

Now here comes the tricky part. **YOU** are not in the basement, but there is somebody whose eyes you see through. That person is your character. An *imaginary individual* that is your playing piece in this game. Just like an actor assuming a *role* for a movie, you play a *fictitious character* in the game. It is your *imaginary character* who is standing on those basement stairs. It is your *imaginary character* who has psychic powers and who reacts and interacts with the other playing pieces . . . the other characters.

Normally, you will spend an hour or more developing a new player character. Once the character has been created, you will probably continue playing the character for many weeks, perhaps



even years.

In our example, your *character* is standing on the lower steps to the basement. The sun is setting and a chilling laughter is softly coming from below the very steps he (or she) is standing on. (Remember the scene, the setting? See how it all comes together now?)

### Imagine the Action

Actually, you need one more important ingredient to make a role-playing game work, the **game master**. The game master (G.M.) is another player (a real person) who controls and acts out all the characters in the game which are *not* the characters of other players. It is also the game master who, like the director of a film, establishes the setting, introduces antagonists and keeps the action moving. This means the game master will play/act out the friendly police officer, the grumpy old man, and the hideous *thing* under the stairs. In this case, you are the only player and I am acting as the game master (G.M.).

*The game master says to you:* "You hear this hoarse, rasping laugh coming from below the steps you are standing on. You realize that on open steps *it* can grab your ankles. What are *YOU* (your character) going to do?"

At this point, you must decide what your playing piece, your *character*, is going to do. Does he slowly bend down to see what's under the stairs? Does he try to run up the stairs? Perhaps he leaps down the last few steps and tries to run to the tool shed to get a weapon and bar the door. The decision is yours. The game master will have your opponent(s) respond to your character's actions. Like improvisational theatre, you, your fellow players and the game master, are all building an adventure, a story. When the game is over you'll have a complete chapter of a larger story forever locked in your memory. A story that you helped create.

In a role-playing game there are no simple answers. There are also almost no limits to what you can do. The only restrictions are that you can not go beyond the physical, mental and emotional limits of your *character*.

### What You Need to Play

Other than imagination, 2 or more players, and a game master, you will also need the following:

1. Dice: 2 four-sided, 4 six-sided, 2 eight-sided, 2 ten-sided, and 2 twenty-sided.
2. Plenty of pencils and paper.
3. Character log sheets can be xeroxed from this book or simply use paper.

## Glossary OF ROLE-PLAYING GAME TERMS

**Attributes:** These are numbers used to evaluate the strengths and weaknesses of your character. For example: P.P. means Physical Prowess; how smooth, agile and quick a character is in combat. A P.P. of 4 would indicate that the character is pretty clumsy. A P.P. of 10 would be an average, fairly coordinated human being. While a P.P. of 16 or more would belong only to characters with exceptional speed and reflexes. Attributes are also called Statistics or Stats.

**Campaign:** A word used to describe an ongoing game. If you play the same characters with the same game master on a

regular basis, then you are in a *Campaign*.

**Character:** Every player (except the GM) has a character that serves as an imaginary playing piece; also called *Playing Character*.

**Death:** Just as in real life, characters can die. The death of heroes in comic books, or in games, is a fairly rare event. The amount of death in a campaign usually depends on the individual game master. Players should take a character's death calmly. Remember, it's *ONLY* a game. GMs should allow players to roll up a "NEW" character and include it in the game as soon as is appropriate for the ongoing game. However, characters should not be a dime a dozen.

**Dice:** There are a variety of different dice used in role-playing games. First of all, there are the standard six-sided dice; the kind you use for most board games. We call them "D6". Often we let you know how many dice to roll with an expression like: "roll 3D6". This means: "Roll three six-sided dice and add the results together." Dice are also available with four-sides (D4), eight-sides (D8), ten-sides (D10), and even twenty-sides (D20). They are available at most hobby stores.

**Game Master:** (GM) This is the person who controls the game "world". All the non-player characters, innocent bystanders, police and politicians, even the weather, are controlled by the GM.

**Player:** A player is a person who plays a character in a role-playing game.

**Role-Playing Game:** Sometimes called a role-playing game (RPG), or fantasy role-playing (FRP), these are games with game masters and imaginary characters.

**Roll a Twenty-Sided:** Simply roll a twenty-sided die for a number.

**Roll Percentile:** Take two, ten-sided dice of different colors. Let's say we have one green and one red. First, you declare which die will be high ("I call red high"). Next, you roll the dice. First, you read the *High* die and then the *Low* die; just put the numbers together and you have a percentile. For example: "Red is 4 and green is 8, so I have a 48%."

**Run:** This is just a term gamers use to describe playing a game. Example: "He runs an excellent campaign." or "I ran in Kevin's game last week".

**Savings Throw:** This is a roll (usually on a twenty-sided die) to avoid some unpleasant event. For example: A character might have to roll a savings throw to avoid being overcome by tear gas.

**Scenario:** This is a specific adventure that confronts the characters in a role-playing game. A scenario is usually a story with a beginning (hearing about the criminal), a middle (tracking down the criminal's hide-out), and an end (defeating the criminal). Most campaigns are developed around a number of scenarios.



# CREATING A CHARACTER

The creation of a character is relatively simple, requiring seven main steps:

- Step 1: The Eight Attributes (and bonuses)
- Step 2: Hit Points and S.D.C.
- Step 3: Selecting a Psychic Character Class (P.C.C.)
- Step 4: Occupation
- Step 5: Education and Skills
- Step 6: Equipment and Money
- Step 7: Rounding Out One's Character

## Step 1: The Eight Attributes and Attribute Bonuses

ATTRIBUTE BONUS CHART

	17	18	19	20	21	22	23	24	25	26	27	28	29	30
I.Q. add to all skills. One time bonus.	+3%	+4%	+5%	+6%	+7%	+8%	+9%	+10%	+11%	+12%	+13%	+14%	+15%	+16%
M.E. save vs. psychic attack/insanity	+1	+2	+2	+3	+3	+4	+4	+5	+5	+6	+6	+7	+7	+8
M.A. trust/intimidate	45%	50%	55%	60%	65%	70%	75%	80%	84%	88%	92%	94%	96%	97%
P.S. Hand to Hand Combat: Damage	+2	+3	+4	+5	+6	+7	+8	+9	+10	+11	+12	+13	+14	+15
P.P. parry, dodge and strike bonus	+1	+2	+2	+3	+3	+4	+4	+5	+5	+6	+6	+7	+7	+8
P.E. save vs. coma/death	+5%	+6%	+8%	+10%	+12%	+14%	+16%	+18%	+20%	+22%	+24%	+26%	+28%	+30%
save vs. poison & Magic	+1	+2	+2	+3	+3	+4	+4	+5	+5	+6	+6	+7	+7	+8
P.B. Charm/impress	35%	40%	45%	50%	55%	60%	65%	70%	75%	80%	83%	86%	90%	92%
Spd: No special bonuses other than the raw, natural ability to run.														

The first step in creating a character is to roll up the eight attributes: I.Q., M.E., M.A., P.S., P.P., P.E., P.B., and Spd. The eight attributes represent your character's natural, mental and physical abilities. Some of the physical skills will increase your physical attributes, so it may be wise to write them in pencil until all modifiers and bonuses are accounted for.

Three, six-sided dice are rolled to determine each attribute. The higher the number, the greater the ability. If an attribute is "exceptional," (16, 17 or 18) then an additional six-sided die is rolled and added to the total for that attribute.

**Intelligence Quotient (I.Q.):** Indicates the intelligence of the character. The exact I.Q. is equal to the I.Q. attribute multiplied times ten. Characters with an I.Q. of 17 or better will receive a one time bonus added to all the character's skill percentages.

**Mental Endurance (M.E.):** Measures the amount of mental and emotional stress the character can withstand.

**Mental Affinity (M.A.):** Shows the character's personal charm and charisma. Natural leaders, with an M.A. of 17 or higher, have a bonus to invoke trust or intimidation in others.

**Physical Strength (P.S.):** This is the raw physical power of the character.

**Physical Prowess (P.P.):** Shows the degree of dexterity and agility of the character. A P.P. of 17 or higher is rewarded with bonuses to dodge, parry and strike.

**Physical Endurance (P.E.):** Demonstrates the character's stamina and durability. The amount of physical punishment, and resistance to fatigue and disease, are determined by P.E. A character can carry the maximum weight load for the P.E. times 4 minutes. Carrying the maximum weight while running or fighting can only be done for the P.E. times 2 minutes. If

a character lifts the maximum weight, then it can only be held for as many melee rounds (15 seconds each) as the character has points of P.E. A character can run at maximum speed for one minute for each point of P.E. Characters with a P.E. of 17 or better receive bonuses to save vs. coma, death and toxins.

**Physical Beauty (P.B.):** Is an indication of the physical attractiveness of the character. A P.B. of 17 or better will be rewarded with a bonus to charm or impress.

**Speed (Spd):** Specifically, this is the character's maximum running speed. The Spd. times 20 is the number of yards or meters that the character can run in one minute.

### DIFFERENT APPLICATIONS OF PHYSICAL STRENGTH

#### Weight

*Normal characters*, with a P.S. of 3 to 16, can carry 10 times their P.S. in pounds (P.S.  $\times$  10 = total in pounds). **For Example:** A character with a P.S. of 9 can carry 90 pounds. A character with a P.S. of 15 can carry 150 pounds.

*Strong characters*, with a P.S. of 17 or higher, can carry 20 times their P.S. in pounds. This means a character with a P.S. of 18 can carry 360 pounds.

*Supernatural creatures are even stronger than extraordinary humans.* Creatures with a P.S. of 18 or higher can carry 50 times their P.S. Thus, a creature with a P.S. of 24 can actually carry over half a ton, 1200 pounds! Creatures with a strength of 17 or less are equal to humans; P.S.  $\times$  10 in pounds.

**Lifting weight** is a little different than carrying weight. You may have noticed, yourself, that you can usually lift up a heavier amount than you can carry. I'm not talking about weight-lifting



in a body building sense, nor lifting a heavy weight above the chest. Simply the ability to bend over and lift something that weighs more than you can carry. *The simple rule is that a character can lift TWICE as much as he/she could carry.* This means that the character with a P.S. of 9 can carry 90 pounds but, *can lift* 180 pounds. Meanwhile, the super strong creature, with the P.S. of 24, can lift over one ton (2400 pounds).

### Throwing Heavy Objects

A character can not throw more than he can carry.

### General Effective Range

Object	Normal Person	Extraordinary	*Supernatural
	P.S.3-16	for Humans P.S. 17-30	Creatures P.S. 18-Up
½ pound object	50ft	100ft	300ft
Dart	30ft	60ft	100ft
Throwing Axe	80ft	150ft	300ft
Javelin	100ft	200ft	400ft
Spear	60ft	120ft	220ft
Knife	50ft	100ft	200ft
Sword	15ft	30ft	60ft

\*Add one foot to the effective range for every P.S. point; i.e., P.S. 24 add 24 feet.

**Note:** Objects such as bricks, bottles, and swords are not designed for throwing. Consequently, the effective range is limited regardless of the strength behind it. Darts, knives and throwing axes are designed for throwing, but don't have the weight or balance for great distances. The same is true of most objects weighing less than half a pound. Javelins, more so than spears, are designed for distance throwing.

Miscellaneous items weighing over a pound and less than 10 pounds, such as rifles, can be thrown about *half* as far as the ½ pound object. Normal and extremely strong characters can hurl a weight equal to the weight he can carry four inches per each P.S. point. This means the person with a P.S. 9 can toss 90lbs up to 2½ feet away. The hero with a P.S. of 17 can toss 340lbs up to 5 ft 6 inches away. **Supernatural strong** can hurl their maximum carrying weight one foot (0.3m) per P.S. point. So the character with a P.S. of 24 can hurl up to 1200 pounds a whopping 24 feet (7.5m).

### Movement and Exertion

Keep the game simple and quick moving. Light activity, such as walking, jogging, driving, standing guard, doing repairs and similar activity, can be conducted indefinitely without affecting the character adversely. Both players and game master should apply common sense and logic to the duration of an activity. Even intense activity, such as 20 minutes of combat followed by rest or light action, will not impair the character's efficiency. It's all a matter of pacing.

Prolonged periods of combat or heavy exertion (an hour or more of intense, continual, physical exertion) will take its toll on the character. Reduce the following once every hour:

- Speed - 2
- Initiative - 2
- Parry and Dodge - 1
- Damage - 2

## STEP 2: Hit Points & S.D.C.

### HIT POINTS

Hit points might best be thought of as life points because they indicate how much physical damage (cuts, bruises, etc.) a character can withstand before he/she dies. These are the points that are observed during a battle (or melee) to determine how much damage is inflicted on friend or foe. Each time a character is struck by a weapon he takes physical damage. The individual players keep score of how many hit points their character has by subtracting the damage from his/her character's hit points each time that character is hit by a weapon. Likewise, the game master keeps score of how much damage the player inflicts upon his opponent. When a character has zero hit points, he is in a coma and will soon die unless extensive medical aid is applied. When a character's hit points have been knocked far below zero, he is dead and beyond saving.

### DETERMINING HIT POINTS

Now that you have some idea of what hit points are about, let us get into the technical aspects of their determination and use.

1. **Base Hit Points:** Having rolled up your 8 attributes, you will recall that one is **physical endurance** (P.E.). The physical endurance score indicates your character's base/starting amount of hit points. This number means that he/she can lose that many hit points before dying.

Some of you will have a character with many hit points . . . don't get too cocky; a gun or even a knife in the right hands can whittle you down to size in one melee round. Others will find themselves with a character who has only a handful of hit points (as little as 3) . . . don't despair or feel cheated; you'll just have to use cleverness and cunning in avoiding direct confrontations until you've built up your hit points.

2. **Building Hit Points:** After determining your base hit points, pick up one six-sided die, roll it, and add the number rolled to your hit point base. Only roll one six-sided die one time.

As your character grows in knowledge and experience he will gain more skill and expertise in his chosen profession. At the same time he will also mature physically, increasing his hit points. Thus, each time a character attains a new experience level, roll one six-sided die and add it to the existing hit points.

### S.D.C. or STRUCTURAL DAMAGE CAPACITY

There are two types of S.D.C. The first applies to living creatures and is a sort of supplement to hit points. The second applies to inanimate, non-living structures such as chairs, locks, doors, buildings, vehicles and so on.

**Determining physical S.D.C. is simple.** Characters with a military, police, detective, or athletic occupation or background roll three 6-sided dice (3D6) for S.D.C., while all others roll two 6-sided dice (2D6) for S.D.C. This S.D.C. base can be increased through physical skills, such as boxing. In this way you can build and toughen your character as much as you'd like. *All S.D.C. points/bonuses are cumulative.* Players, a word of caution! Although the characters in **Beyond the Supernatural** may have psychic or magic abilities, they are mere mortal men and women with human frailties. They are just as vulnerable to blade and bullet, tooth and claw as any normal person. The character's will have to use more than muscle to survive.





When a character is hurt, the damage is *first* subtracted from his or her *S.D.C. points*. *S.D.C.* damage is painful, but not deadly. It's like a movie where John Wayne gets shot, punches it out with three desperadoes, and when it's all over, dusts himself off and says "Ah shucks mam, it's only a scratch." *S.D.C.* in action. *It is only after ALL S.D.C. has been depleted that damage is subtracted from hit points. Hit point damage is serious, and potentially life threatening.*

*Inanimate objects, such as buildings, vehicles, furniture and so on, also have S.D.C.* In this case, the *S.D.C.* indicates the total amount of damage that the object can withstand. These *S.D.C.* function exactly like hit points, except that they apply to non-living things. Any damage sustained is subtracted from the *S.D.C.* When the *S.D.C.* is reduced to zero, it is broken or smashed beyond repair. **A NOTE TO THE GAME MASTER:** The *S.D.C.* system just described is a standard rule in most Palladium Books® games. From time to time I hear the complaint, for example: How can somebody be bashing or shooting into a door and the door is in perfect condition until all its *S.D.C.* are depleted? My answer is: It's not in perfect condition. Using the example of the door, the G.M. should explain exactly what's happening. "You bash into the door with your shoulder. Its a very solid door and you inflict minimal damage (give *S.D.C.* damage). You realize that it will take quite a while to gain entry this way and you may hurt yourself." Or "You can feel the door give a little under your great strength (give *S.D.C.* damage). Another bash and the door's frame cracks and moans, but it still holds (give *S.D.C.* damage). It will take another couple of attempts (as the door's *S.D.C.* dwindles), but it's definitely giving." Or "Your sub-machinegun riddles the wood door with a dozen holes (something the player can look through), but the door is still locked and holding strong." Obviously, attacks on normal objects will scrape, dent, crack, splinter, crumble and so on, even if the object is not destroyed. To smash or destroy something may require multiple attacks, and in some cases, like being locked behind an iron door or bulkhead without a weapon or proper tools, it will be impossible to damage the item at all.

**Artificial armor**, such as bulletproof vests or armor, also has an *armor rating (A.R.)* and *S.D.C.* The **armor rating** indicates exactly how much protection is afforded by the armor and how easily it is penetrated. The higher the *A.R.* the better. If an attack roll to strike is less than the *A.R.* of the armor, the armor absorbs the attack; subtract the damage from the armor's *S.D.C.* When the armor's *S.D.C.* is depleted, it no longer affords protection and is useless.

If an attack roll to strike is *higher* than the armor's *A.R.* it penetrates the armor, inflicting damage to the physical body's *S.D.C.* (not the armor's *S.D.C.*) and/or hit points.

**Natural armor** usually applies to many supernatural beings;

some who physically transform, or who have a natural protective skin or covering. In these cases, any roll to strike which falls *under* the character's natural *Armor Rating* strikes, but inflicts no damage. Bullets bounce off harmlessly, lasers are deflected, and combat continues. *A roll above* the natural *A.R.* strikes and inflicts *full damage*, first to the *S.D.C.* and then to the creature's hit points.

### RECOVERY OF HIT POINTS and S.D.C.

After a battle, characters who have sustained physical damage must tend to their wounds. The attending of wounds can be administered by fellow characters, trained medical personnel or by oneself, if the character has first aid skills and is not physically impaired.

First aid-type skills include basic and immediate medical treatment, such as bandaging and cleaning of wounds, stopping of bleeding and so on, until the character can receive better medical care.

**Recovery: Nonprofessional treatment.** This is basic, first aid-type treatment by oneself, or non-medically trained people. This type of treatment may be used if the character is not able to seek professional treatment immediately. It is not necessarily inferior treatment, especially for a not too serious ailment, but just lacks the full facilities and experience of a major medical institution. **Rate of Recovery:** Two hit points per day (24 hours) and/or 4 *S.D.C.* points per day.

**Recovery: Professional treatment.** This is medical treatment from a doctor, clinic, hospital, or psychic healer. **Rate of Recovery:** Two hit points per day for the first two days, and four hit points per day for each following day, until the character has regained all his/her original hit points. *S.D.C.* points are restored at a rate of 6 per day.

### SURVIVING COMA AND DEATH

When a character's hit points are reduced to zero (or less), he/she collapses, lapsing into a coma. This character is near death, and will die in a matter of hours unless he/she receives immediate medical treatment.

How much damage below zero a character can undergo is indicated by the physical endurance (*P.E.*) attribute. A character can take one point of damage below zero (negative 1, -2, -3, etc.) for each *P.E.* point. **Example:** A character with a *P.E.* of 9 will lapse into a coma at zero hit points, but still lives up to a negative 9. However, if the character receives more damage (which is very possible) than the *P.E.*, he is dead, with no hope of recovery. Thus, if a character with a *P.E.* of 9 takes 10 points or more below zero, exceeding his *P.E.*, he is beyond medical help and dies.



## Coma Length

The length of time a character in a coma will survive without treatment is again indicated by the P.E. Add one hour for each P.E. point. **Example:** P.E. 9=9 hours, P.E. 10=10 hours, and so on.

## Recovery From a Coma

Whether or not a character survives the coma and is stabilized (brought back to, at least, one hit point above zero) is determined by the roll of percentile dice. If the player rolls two, successful recovery rolls out of three tries, the character breaks out of the coma and is no longer in danger of dying. This also means that he is brought up to one hit point above zero. Recovery of hit points from that time on is standard; see Recovery of Hit Points. **Note:** This can be attempted every hour.

## Recovery Ratio (roll 2 out of 3)

- Treatment from nonprofessional, medical individual, but with medical skills: 1-18%
- Treatment from an intern or nurse (R.N.): 1-32%
- Treatment from a doctor without proper facilities: 1-46%
- Treatment from a doctor at a clinic (fair facilities): 1-56%
- Treatment from a hospital: 1-66%
- Treatment from a major, large hospital: 1-70%.

## Optional Recovery Side-Effects

### From Severe Damage/Near Death (Hit Points)

Roll on this table when a character has lost all of his/her hit points and has been near death (coma). **Impairment is permanent** as a result of the grave physical damage. **NOTE:** This is not a mandatory table, but is left up to the game master's discretion.

- 1-10 No permanent damage.
- 11-20 Major stiffness in joints; reduce P.P. by 2.
- 21-39 Minor stiffness in joints; reduce P.P. by 1.
- 40-55 Legs impaired; walk with a limp reduce Spd by 2.
- 56-70 Major scarring; reduce P.B. by 2.
- 71-82 Chronic pain; reduce P.E. by 1.
- 83-92 Minor brain damage; reduce I.Q. by 1.
- 93-00 Major brain damage; reduce I.Q. by 2 and M.E. by 1.



## OPTIONAL DAMAGE RULES

A character receives serious physical damage when he loses a great amount of hit points. The following is a list of side-effects from physical damage. The effects of the damage are generally temporary and cumulative. Thus, if a character suffers the loss of a great deal of hit points within a short time, he will suffer the multiple effects of physical damage. **Roll each time severe damage is endured.**

Roll Percentile	Damage	Minuses
1-14	Minor bruises and lacerations.	Spd - 2 - 1 to dodge
15-29	Severely bruised and battered muscles	P.P. - 1 Spd - 3
30-44	Damaged (sprain, pulled, cut, etc.) arm or shoulder.	P.P. - 3
45-59	Damaged leg or hip.	Spd is 1/2 - 2 to dodge
60-74	Damaged hand and/or wrist	P.P. - 1 P.S. - 2
75-89	Head Injury	- 5% on all skills; Spd - 2
90-00	Damaged back or pelvis.	P.E. - 1 P.P. - 2 Spd - 3

**NOTE:** None of these effects are permanent nor life threatening. Minuses apply to that one limb. Speed minuses affect the whole body. Remember effects are cumulative; roll each time the character is badly hurt.

## Side-Effects from Physical Damage (Hit Points) (Optional)

Roll on this table when 75% to 99% (almost all) hit points are depleted. Impairment is temporary, lasting 1-4 weeks (roll one four-sided die).

Roll Percentile	Damage	Minuses
1-10	Severely battered and bruised	Spd - 2 - 3 to dodge
11-20	Torn arm muscle	P.P. - 3 P.S. - 2
21-29	Torn leg muscle	Spd is 1/2 - 2 to dodge
30-39	Fractured bone: arm	P.P. - 2 P.S. - 3
40-49	Fractured bone: leg	Spd is 1/2 - 4 to dodge
50-59	Fractured bone: ribs or pelvis	P.E. - 2 Spd is 1/2
60-69	Broken bone: arm	P.P. is 1/2 P.S. is 1/2
70-79	Broken bone: leg	Spd is 1/3 - 6 to dodge
80-89	Broken bone: ribs	P.E. - 3 P.P. - 1 Spd - 3
90-00	Severe Concussion	- 8 on all skills, Spd - 3



## STEP 3: Selecting A Psychic Character Class

Before deciding on an occupation and skills, it is best to select your character's psychic character class P.C.C. Most of the player characters in **Beyond the Supernatural** will have some type of psychic powers or familiarity with magic or supernatural forces. Exactly which psychic character class (P.C.C.) you select, as well as the abilities you chose, may affect your decision on an occupation and appropriate skills.

**Each player character class** has a complete description of the "focus," skills, abilities, and bonuses available to that particular type of character. Each has its strengths and weaknesses. Don't make a hasty decision; at least glance through each P.C.C. to get an idea of what they can do. After you've studied each, select one, and proceed to develop the psychic aspect of the character as described that section. Players should take note that this is *not* a superhero game; consequently, the powers and abilities are generally restrictive and limited. If used cleverly, with proper timing, they can have devastating effects, but the powers, alone, will not be enough to combat the supernatural forces you will face. *Teamwork* will often mean the difference between life and death; so players may want to consider what P.C.C. and abilities their fellow players are selecting in order to build a well rounded team or group of characters. This does not mean that every player should select a different P.C.C.; it simply means to consider the desired scope and versatility of your team when selecting a P.C.C., psi-abilities and skills. The cast of characters and their respective P.C.C.s will depend on the number of players and personal preferences. I would recommend that players go with what they feel most comfortable playing, above all else.

### P.C.C. REQUIREMENTS

There are no special requirements for most of the psychic character classes. The only exceptions are the Mage/Arcanist and the Parapsychologist, both of which require a minimum I.Q. and mental endurance (M.E.).

### SKILLS AND OCCUPATION

Once all the particulars of the psychic character class (P.C.C.) are determined, it will be time to decide on the character's skills and occupation. Not all psychics will be professional psychic investigators, nor is it likely that their special abilities will help them in any kind of career. This means the character will probably have skills that relate to the normal world, as well as the paranormal. It may be necessary to hold a job completely unrelated to the supernatural to survive. In some cases, like the Genius P.C.C. or parapsychologist P.C.C., the character will receive skills and skill bonuses that are in addition to their normal, formal, education. Others may be able to use a particular psychic ability to augment or assist in a job or skill area, such as electrokinesis. In addition, some will have developed very specialized skills for dealing with the supernatural, such as recognize enchantment or possession. *All P.C.C. skills are in addition to scholastic and secondary skills.*

### NO MULTIPLE P.C.C.s

A character can *not* fit into more than one psychic character class (P.C.C.). Each P.C.C. is a direct result of a focus or

channeling of potential psychic energy into a specific mental and emotional orientation. The nature of psychic energy and the intensity of focus does not allow for the combination of philosophies or powers. Thus, each character can be only one P.C.C. A psychic character class is far different from the usual occupational character class (O.C.C.). It reflects the character's psychic focus and special, psychic abilities/skills. The P.C.C. is an orientation, a train of thought and direction. It does not dictate an occupation or schooling, nor the selection of skills. P.C.C. abilities, whether they are powers or skills, are in addition to conventional studies. What the P.C.C. does is gives your character an orientation and insight into the paranormal. It is his or her edge against the supernatural.

The psychic character class is what makes your characters different than most people in the world. The knowledge gained from a P.C.C. has given the character an insight into himself and other forces unrecognized by the average person. Obviously, this insight has changed the character's life.

## STEP 4: Occupation

An occupation should be looked upon as two things: 1) An area of skill expertise; and 2) A means of employment to pay the bills. Neither may apply to the supernatural. The world of *Beyond the Supernatural* is a contemporary world much like our own. Paranormal investigator and psychic extraordinary are not, generally, considered to be an excellent means of gainful employment. Displaying, quote, "inhuman" or "unnatural powers," end quote, is more likely to get you fired or killed. Normal people don't believe in psychic abilities or the supernatural. Oh, certainly they eat-it-up at the movies, in comic books and science fiction literature, but not in real life. No way! Consequently, anyone who blatantly displays unnatural powers (without an excellent cover story) will be branded as a freak, mutant, monster or demon-spawn. The character is likely to become an instant victim of extreme prejudice, suspicion and fear, even if he or she just saved a life. Sadly, it seems to be human nature to fear what we do not know or understand, and in turn, shun or destroy what we fear. This can make the character the target of police, scientific and/or military investigations, cruel jokes, harassment, and physical attacks from those who fear or hate out of ignorance and prejudice.

There are several ways to use one's psychic abilities without creating an uproar. One is to disguise them within a given occupation. Many abilities are unobtrusive and can be easily employed as a hunch; "What if we look over here." or "Hey, I just took a lucky guess." Even some of the more flamboyant abilities, such as telekinesis or pyrokinesis, can be done discreetly so that nobody notices or does not draw any connections to the "unusual" incident. A more obvious, but equally effective tack is to select or build an occupation around the character's abilities. This could include the stage magician, escape artist, circus act/entertainer, psychic investigator, fortune-teller, mystic, or the collector and seller of the bizarre. A resourceful player should be able to disguise the use of any psychic abilities in almost any occupation.

Another solution is to select an occupation that offers a lot of mobility and self management, like a detective or a reporter. This would often allow the character to use his abilities alone and unobserved. Of course, the safest answer is to avoid using



psi-abilities and to take a job that has nothing to do with the paranormal nor offers any opportunity to use psychic powers. All of these occupations establish a sort of secret life or identity for the character (plumber by day, psychic by night); a dual existence enabling him or her to deal with the supernatural in an unobtrusive, covert fashion.

The selection of an occupation is important because it establishes the character's means of support (wealth), freedom to come and go as he wants (or lack of it), public perception (how people see the person), whether or not the character is known for paranormal knowledge or abilities and establishes other available resources, possibly available through the job (computers, data, equipment, etc.). An occupation that does not, in some way, take into consideration the character's involvement with combating supernatural forces will be restrictive and inflexible. This is okay too. Just remember that missing a lot of work, especially leaving without notice and failing to show up, or poor workmanship because of exhaustion, is likely to get you fired. This could mean a character who is continually drifting from one job to another.

### A Look at Paranormal Employment

Occupations that overtly deal with the supernatural or paranormal have three problems. First, there are not a lot of available positions. Second, pay is usually poor. Third, it is a job that lacks respect and credibility. Most people will regard even a trained scientist as a crackpot if he believes in the supernatural forces. However, this type of occupation will provide characters with the mobility and freedom they will need to confront supernatural evil. Let's explore some of the possibilities.

**A parapsychologist and his investigative group** or research team are usually acknowledged as having a base rooted in science. Indeed, the parapsychologist(s) has a background of formal study in psychology and the sciences. He is also familiar with the theories and workings of psychic powers and paranormal phenomena. More likely than not, the parapsychologist is funded by a university, scientific research organization, private industry, or even the military, or a philanthropic society or individual. The other members of the research team can be reputed psychics, scientists, aids and assistants. This is convenient because all or most of the players can be official members of the team and get paid for psychic investigation. It keeps the group together without causing suspicion and gives them all mobility. It also gives them limited access to scientific equipment (not weapons) and transportation. If this is going to be the player's approach to employment it will be useful to select skills that will help them in their profession. Pay: The parapsychologist (P.C.C.) character(s) will receive the best yearly salary — \$20,000 plus  $2D6 \times \$1000$ . Characters with training in the paranormal (including lore skills), but who are not parapsychologist P.C.C.s, can be considered psychic investigators, aids and assistants to the parapsychologist. This character can be psychic too. Their salary will be \$13,000 plus  $2D4 \times \$1000$ . Psychics hired as subcontracted, freelance advisors or assistants will be paid a flat \$80.00 per day plus travel expenses. The least expensive means of lodging is usually, but not always, provided. Yearly travel expenses for *authorized* research expeditions will rarely exceed \$80,000, so be frugal with expenses. This is not a lot of money, especially for a group of people. **Note:** While this occupation sanctions paranormal research and allows for globe-trotting, the characters employed must still answer to a higher authority; probably the big boss or

a board of directors who owns and operate the research operation. This also means that big expenses with nothing to show for it could lead to layoffs or being fired.

**Other, more metaphysical, occupations** could include fortune-teller, psychic advisor, spiritualist (traditionally, a combination seance medium and clairvoyant), self employed psychic investigator, or any number of traditional, mystic-type occupations, such as palmist, diviner, soothsayer, mage, astrologer, crystal gazer, prognosticator, and similar. Unfortunately, all of these occupations have shady reputations as quack science, or out and out chicanery. Thus, most people will regard persons of such employment as flim-flammers and swindlers. To make matters worse, there are hundreds, if not thousands, of con artists and finaglers, defrauding naive and desperate people under the same pretext. The supernatural is an area of the unknown that unscrupulous profiteers have managed to manipulate to their favor throughout the ages. To make a living at such a disreputable profession may be difficult, but it certainly offers maximum mobility and an excellent front for odd occurrences. Of course, the next trick is figuring out which clients aren't a little wacko themselves and which have a *real*, supernatural problem.

If a character or several characters decide to take this approach, the game master should start them off as a new, inexperienced business and let it grow (or fail). As partners in a *new*, small business, salaries will be very small initially; probably under \$15,000 apiece and directly subject to how much revenue is being generated by the business. Hard times could mean sharing an apartment, with barely enough money to live on. Of course, good times could mean three or four times as much money. **Note:** In a game context, the services offered by a *psychic investigation agency* (or similar person/business) are likely to include determination of a supernatural or magic presence, the nature of that presence (benign, evil, hostile, dangerous/deadly, harmless, mischievous, etc.), the root cause of the disturbance (magic, ley line, psychic, dimensional rift, etc.), and a practical solution to the problem (extermination, relocation, communication/negotiation, means of protection, and so on). Other services might include consultation, advice, protection from supernatural forces (bodyguard and/or surveillance), and scientific and/or historical research (the latter would apply to the history of an area or building, or person or object, etc.).

**Conventional occupations** that best lend themselves to supernatural investigation would include private detective and the journalist (freelance or represents a newspaper or magazine). Others might include historian, researcher, scientist (especially archaeology and anthropology), foreign language translator, importer/exporter, photographer, or museum representative.

**A freelance journalist** would have the most flexibility, but is paid by the article. A typical newspaper article generally pays \$100 to \$200, special features \$300 to \$600. Blockbuster articles are big ticket, front page articles, usually dealing with a major crisis, expose, conspiracy, odd or spectacular murder; involves important names/people or industry, and/or exclusive interview or data or photo of/with one of the people involved. The blockbuster story will usually net the freelance reporter \$2000 to \$10,000, with another few thousand dollars for rare photographs or strong follow-up story. A super big story could bring in ten times as much, plus movie and book rights, but that kind of opportunity is super rare; one chance in a lifetime. It is also not likely to be the kind of story a paranormal investigator will



fall into. "President attacked by creatures from another world." is not the kind of blockbuster story that makes it into the news. Stories like "Monsters live in Philadelphia Sewers" will usually see print only in the sensationalizing, supermarket tabloids that clutter the check-out line. Of course, pay ain't bad, about \$200 to \$600 per article, and same for a good photo. Freelancers who have a name/reputation that sells papers can command twice or three times the going rate.

**Journalists** who represent a specific newspaper, magazine, or news agency, will draw a salary with bonus. A good, proven, investigative reporter will earn \$30,000 to \$50,000 plus  $3D6 \times \$1000$  a year in bonuses. Double the salary and bonus if the character becomes a *big-name* author. **An assistant investigative reporter**, the leg-man of the research department, will make about \$20,000 to \$25,000 per year with a  $2D6 \times \$100$  bonus. A typical, no-name *photographer* will make about the same.

**Typically non-skilled laborers** such as, non-union warehouse worker, waitress, office boy, salesclerk, guard, assistant to almost anybody, and so on, make \$10,000 to \$16,000 per year. **Skilled laborers**, such as mechanic, electrician, plumber, carpenter, computer repair, private detective, police, truck driver, technician, scientist, and so on, will earn \$25,000 to \$40,000 per year. **Skilled white-collar workers**, such as stage magicians, managers, computer programmers, commercial artists, executive assistants, translators, brokers, insurance agents, and similar, make about \$25,000 to \$50,000 per year. Note that this is the typical income average. The typical American makes about \$20,000 to \$35,000 annually. So most skilled occupations will pay somewhere within that range. Presumably, most characters in this game are skilled.

Remember, that the character can select any occupation. The individual may be employed as part of a group or independently. That occupation may reflect his or her involvement in the paranormal or be completely removed from it. A resourceful player will make any occupation work to his advantage.

## STEP 5: Determining Education and Skills

The determination of education and skills is very simple. A player rolls on the Educational Level Table. The table will indicate the type of education (high school, college, military, or trade school), educational bonus (a one time bonus applied to all the skills in a skill program; it does not apply to secondary skills), and the number of skill programs and secondary skills which can be selected. The choice of skill programs and individual secondary skills is left up to the player. The average character will have about 15 to 20 skills. Remember to choose skills that will help your character in fighting the supernatural. *See Education and Skills for details.*

It is important to reiterate that the character can be any occupation. The selection of skills should reflect and supplement that occupation. At the same time, players must think about their character's needs as a warrior against supernatural evil. The skill selection rules should provide players with the means to create a viable, well-balanced character.

A few words about the parapsychologist and magic user are warranted. Although the parapsychologist and mage/arcanist are

both psychic characters classes (P.C.C.), a player can still mold another P.C.C. into a psychic investigator. Technically, anyone who researches and investigates the paranormal or supernatural can be considered a psychic investigator. However, available scholastic and secondary skills will enable you to build a character who is knowledgeable in paranormal phenomena and the supernatural (see Lore skill). Careful selection of skills can produce a great variety of characters who qualify as real psychic investigators. *See skill section for Education and Skill descriptions.*

## STEP 6: Equipment and Money

Each character has a number of "common" personal items such as a modest wardrobe, stereo, T.V., VCR, furniture, appliances (stove, refrigerator, clock, telephone), knickknacks and so on. None of these items are outrageously expensive (no \$6000 stereo system; more like \$1000 or less). Expensive and extravagant purchases must be made from personal savings or earnings. Scientific equipment, weapons and special items must also be purchased (*See equipment section*). Roll on each of the following tables to determine life savings, inheritance and related. All rolls should be made in front of the game master. All rolls are percentile.

### One: Life Savings

1-12	\$1000
13-26	\$2000
27-38	\$3000
39-50	\$4000
51-63	\$6000
64-76	\$8000
77-88	\$10,000
89-00	\$12,000

### Two: Inheritance

In addition to earned savings the character has inherited money or property from a friend or relative.

- 1-10 Cash!** Only  $2D6 \times \$1000$ .
- 11-20 Comic Book Collection:** Value at list price is  $4D6 \times \$1000$ , but will require 3 to 12 months (roll  $3D4$ ) to liquidate. Quick sale to a dealer will get 30% of the full value.
- 21-30 Cash!** Only  $4D6 \times \$100$ .
- 31-40 Blue Chip Stocks:** Total number of stocks is  $2D4 \times 100$ ; each stock is worth approximately \$100.00 EACH. **Note:** The stock will fluctuate in value, going up and down in the market. If the character sells immediately the stocks are worth \$100 each, minus a 2% broker's fee. If the character sells some and keeps some, the remaining stock may go up or down in value. For fun, the game master or the player should roll once per month of imaginary game time to see if the stock is going up or down in value. To do this, roll a 20-sided die; 1-10 is down, 11-20 is up. The increased or decreased value will be 1 to 20 dollars, so again roll a 20-sided die. All increases and decreases in value are cumulative. **Player Tip:** Sell a quarter to half of the stocks immediately at the full \$100 value and take a chance on the rest. A 2% fee will be charged by the broker each time stock is sold.
- 41-50 Property:** Uncle Benny left you his *house*. Value is  $2D6 \times \$10,000$ , but to get the full value will take 4 to



16 months (roll 4D4). Quick sale means reducing the asking price by 30%.

**51-60 Trust Fund:** 3D4 × \$10,000 has been set aside for the character by a benefactor. However, the character can only draw on 10% of the total available money per year. When the total reaches a minimum of \$10,000 the character will receive it in a lump sum. The allotment of the money will be carefully dispensed by a law firm.

**61-70 Property:** Aunt Maybelle saved *coins* for fun since she was a kid and she's left them to you. Value: 2D4 × \$10,000; but to get full value will take 3 to 12 months (roll 3D4). Quick sale will get 60% of the full value.

**71-80 Cash!** 6D6 × \$1000.

**81-90 Property:** Grandpa's had a thing for *antiques* and now they are your things. Value: 2D4 × \$10,000, but to get full value will take 4 to 16 months (roll 4D4). Quick sale will get 50% of the full value.

**91-00 Bonds:** 1D6 × \$10,000, but they do not reach full maturity and value for 1 to 4 years (roll 1D4). All or some can be cashed prematurely for half value.

### Three: Automobile

**1-33** Brand new, cost: \$18,000 (on payments), player's choice.

**34-70** Bought new, 1D6 years old; almost all paid for.

**71-00** Clunker, bought used; 2D6 years old.

**Note:** A large company or research organization is likely to provide, at least, limited use of its facilities and equipment. This may include laboratory facilities, medical equipment, access to computers and company data base, field equipment, uniform (if any), camera equipment (if any) and use of a company car.

## STEP 7: Rounding Out One's Character

The final step is to add color to your character. The only mandatory requirement is the selection of an **alignment** and understanding how the **experience levels/system** applies to you. Everything else is optional, including insanity. Use it or do not. Insanity rules will be most appropriate in long campaigns.

## ALIGNMENTS

### THE ALIGNMENTS

**Good:** Principled and Scrupulous

**Selfish:** Unprincipled and Anarchist

**Evil:** Miscreant, Aberrant and Diabolic

Alignments are an important factor in developing a character, his/her attitudes and moral principles. ALL players *must* choose an alignment for their character.

### NEUTRAL

First of all, there is *no* such thing as an absolute or true neutral. All people tend toward good, evil or self-gratification. An absolute true neutral could not make a decision, go on an adventure, kill, or take any action of any kind without leaning toward good, evil or self-gratification. It is humanly impossible and is, therefore, eliminated in the context of this game. (I realize that some

of the philosophers out there may disagree with this, but that's a topic for philosophical debate and not a factor of this game. Sorry, no neutrals).

## GOOD ALIGNMENTS

### Principled

#### Scrupulous

Because a character is of a good alignment, it does not make him/her a saint. Good characters can be just as irritating, obnoxious, and arrogant; even prejudiced and full of quirks. However, life and freedom are of the highest priority. Such a person can always be trusted in a life and death situation.

### Principled (Good)

Principled characters are, generally, the strong, moral character.

#### Principled characters will . . .

1. Always keep his word.
2. Avoid lies.
3. Never kill or attack an unarmed foe.
4. Never harm an innocent.
5. Never torture for any reason.
6. Never kill for pleasure.
7. Always help others.
8. Work well in a group.
9. Respect authority, law, self-discipline and honor.
10. Never betrays a friend.
11. Never break the law unless conditions are desperate. This means no breaking and entry, theft, torture, unprovoked assaults, etc.

### Scrupulous (Good)

Scrupulous characters value life and freedom above all else, and despise those who would deprive others of them. This type of hero is typically portrayed in many Clint Eastwood and Charles Bronson films; the person who is forced to work beyond the law, yet for the law, and the greater good of the people. They are not vicious or vindictive men, but are men driven to right injustice. I must point out that these characters will always *attempt* to work with or within the law whenever possible.

#### Scrupulous Characters Will . . .

1. Keep his word to any other good person.
2. Lie only to people of selfish or evil alignments.
3. Never attack or kill an unarmed foe.
4. Never harm an innocent.
5. Never torture for pleasure, but may use muscle to extract information from criminals or evil characters.
6. Never kill for pleasure; will always *attempt* to bring the villain to justice alive no matter how vile he may be.
7. Always help others.
8. Attempt to work within the law whenever possible.
9. Bend and, occasionally, break the law when deemed necessary. This means they may use strong-arm techniques, harass, break and enter, theft, and so on.
10. Distrust authority.
11. Work with groups, but dislike confining laws and bureaucracy (red tape).
12. Never betrays a friend.



## SELFISH ALIGNMENTS (But Not Necessarily Evil)

### Unprincipled (Selfish)

This, *basically*, good person tends to be selfish, greedy, and holds his/her personal freedom and welfare above almost everything else. He/she dislikes confining laws, self-discipline and distrusts authority. This is the Han Solo, Star Wars, character. The guy who is always looking for the best deal, associates with good and evil characters, is continually tempted to lie and cheat, and hates himself for being loyal and helping others.

### Unprincipled Characters Will . . .

1. Have a high regard for life and freedom.
2. Keep his word of honor.
3. Lie and cheat if necessary (especially to those of anarchist and evil alignments).
4. Will not kill an unarmed foe (but will take advantage of one).
5. Help those in need.
6. Not use torture unless absolutely necessary.
7. Work with a group, especially if profitable.
8. Never harm an innocent.
9. Never kill for pleasure.
10. Dislike authority.
11. Never betray a friend.

### Anarchist (Selfish)

This type of character likes to indulge himself in everything. He is the insurgent, con-man, gambler and high roller; the uncommitted freebooter seeking nothing more than self-gratification. This character will, at least, consider doing anything if the price is right. These people are intrigued by power, glory and wealth. Life has meaning, but his has the greatest meaning. Laws and rules infringe on personal freedom and were meant to be broken. An anarchist aligned person is always looking for the best deal, and will work with good, selfish or evil to get it; as long as he comes out of the situation on top. The anarchist is continually teetering between good and evil, rebelling, and bending the law to fit his needs.

### Anarchist Characters Will . . .

1. May keep his word.
2. Lie and cheat if he feels it necessary.
3. Not likely to kill an unarmed foe, but certainly knockout, attack, or beat up an unarmed foe.
4. Never kill an innocent (but may harm or kidnap).
5. Not likely to help someone without some ulterior motive (even if it's only to show-off).
6. Seldom kill for pleasure.
7. Use torture to extract information (not **likely** to torture for pleasure).
8. Does not work well in a group (this is the cocky, loudmouth who is likely to do as he damn well pleases).
9. Have little respect for self-discipline or authority.
10. May betray a friend.

## EVIL ALIGNMENTS

### Miscreant

### Aberrant

### Diabolic

All evil characters are not bent on universal genocide or domination over all living creatures. They are not all maniacal people actively seeking to harm innocent people. Nor are all evil characters sadistic and untrustworthy. Many evil characters may actu-

ally seem kind or likable.

There is nothing wrong with playing an evil character, although he may not survive too long if he betrays or harms too many people. This is fantasy role-playing, not reality. You can play any type of character you desire, just continue to play in character.

Evil alignments are a step beyond the self-gratification of the selfish alignments. Evil characters are ruthless individuals who are willing to say or do anything to achieve their goal. Human life has little meaning to them, and friends tend to be (but not always) people to use, and discard when they are no longer of value. Evil aligned people do not automatically slay any good aligned person because of different ethics and philosophy. All the better to use good to achieve their own goals, for the end always justifies the means.

### Miscreant (Evil)

This self-serving, unscrupulous character is out only for himself. Power, glory, wealth, position, and anything that will make his life more comfortable is his goal. It matters not who gets caught in the middle, as long as he comes out smelling like a rose. This person will lie, cheat and kill anyone to attain his personal goals.

### Miscreant Characters Will . . .

1. Not necessarily keep his word to anyone.
2. Lie and cheat anyone; good or evil.
3. Most definitely attack an unarmed foe (those are the best kind).
4. Use or harm an innocent.
5. Use torture for extracting information and pleasure.
6. May kill for sheer pleasure.
7. Feels no compulsion to help without some sort of tangible reward.
8. Work with others if it will help him attain his personal goal.
9. Kill an unarmed foe as readily as he would a potential threat or competitor.
10. Has no deference to laws or authority, but will work within the law if he must.
11. Will betray a friend if it serves his needs.

### Aberrant (Evil)

The cliché that there is "No honor among thieves." is false when dealing with the aberrant character. This is a person who is driven to attain his goals through force, power, and intimidation. Yet the aberrant person stands apart from the norm, with his own, personal code of ethics (although twisted ethics by the standards of good). He expects loyalty from his minions, punishing disloyalty and treachery with a swift, merciful death. An aberrant person will always keep his word of honor and uphold any bargains. He will define his terms and live by them, whether anyone else likes it or not.

### Aberrant Characters Will . . .

1. Always keep his word of honor (he is honorable).
2. Lie to and cheat those not worthy of his respect.
3. May or may not kill an unarmed foe.
4. Not kill (may harm, kidnap) an innocent, particularly a child.
5. Never kills for pleasure.
6. Not resort to inhumane treatment of prisoners, but torture, although distasteful, is a necessary means of extracting information.
7. Never torture for pleasure.



8. May or may not help someone in need.
9. Work with others to attain his goals.
10. Respect honor and self-discipline.
11. Never betray a friend.

### Diabolic (Evil)

This is the category where the megalomaniacs, violent, and most despicable characters fall. This is the cruel, brutal killer who trusts no one and has no value for anyone or anything that gets in his way. Aberrant aligned characters find these dishonorable people just as revolting as a good aligned character.

### Diabolic Characters Will . . .

1. Rarely keep his word (and has no honor).
2. Lie to and cheat anyone.
3. Most certainly attack and kill an unarmed foe.
4. Use, hurt and kill an innocent without a second thought or for pleasure.
5. Use torture for pleasure and information.
6. Kill for sheer pleasure.
7. Likely to help someone only to kill or rob him.
8. Not work well within a group (consistently disregarding orders to do as he pleases).
9. Despise honor, authority, and self-discipline.
10. Associate mostly, with other evil alignments.
11. Betray friends (after all, you can always find friends).

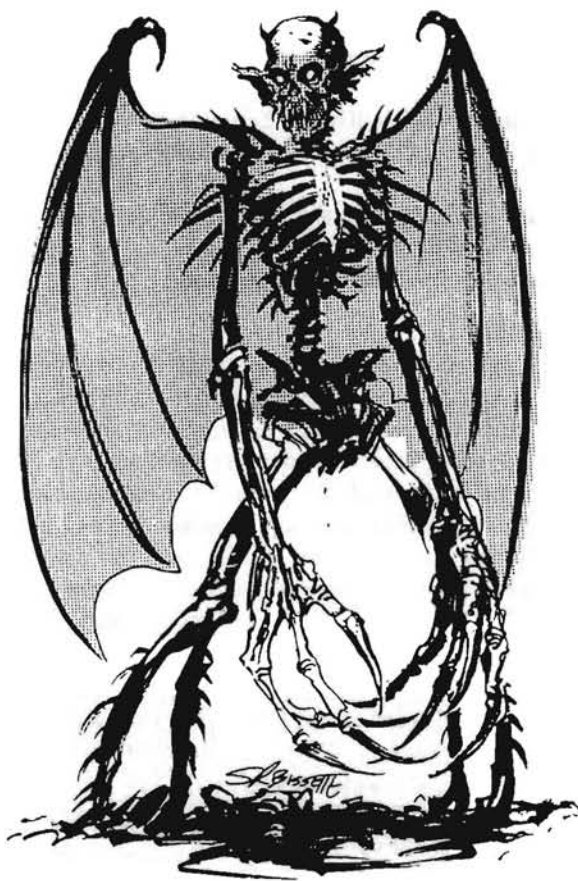

## SUPERNATURAL CREATURES

Supernatural creatures must have an alignment. *Most* will be evil; especially miscreant and diabolic. ALL supernatural creatures, whether they are ghostly entities or slithering monsters, will radiate their alignment. This psychic emanation is part of its nature and can not be hidden or disguised. To a psychic sensitive P.C.C. the emanations of evil are as distinctive and recognizable as a sharp, pungent odor. It will automatically alert the psychic sensitive to the presence of supernatural evil.

Practitioners of magic for evil purposes, or individuals who associate with supernatural creatures do not, themselves, radiate an unnatural, evil aura. However, those who knowingly and willfully use such dark forces are always of evil or anarchist alignment. These are the vengeful, greedy or power hungry fools who will stop at nothing to achieve their goals. Goals they will attain even if it means calling upon horrible, evil forces from another world to prey on their own.

## EXPERIENCE POINTS

Except in specially devised scenarios and tournaments, there is no winner in a role-playing game. The accumulation of heroic deeds, friends, prestige, weapons, equipment, knowledge, and skills, can be construed to be the results of winning. If a character survives and meets with success in his endeavors, that is winning. However, there are rewards besides the acquisition of material goods and reputation, and those are developing your character's skills, knowledge, and abilities. This is accomplished through the gathering of experience points.

### WHY AN EXPERIENCE POINT SYSTEM?

The reason I use an experience point system is because I find them extremely realistic and practical. Training is useful, but there is no substitute for experience. I don't know how many times I have read a comic book with the main character thinking to himself, something like "Only my years of experience enabled me to beat him." or "He's good, but lacked the years of experience and training to handle the situation." Practical experience in the field is an important and real factor in the development of a character.

The experience system is specifically designed so that characters will mature fairly rapidly, tapering off as they reach higher levels of experience (around fifth and sixth level).

Why do the experience levels only go to level 15? Because characters are not likely to ever reach that level, even after years of regular play. In my original, **Palladium Role-Playing Game** play-test campaign, after two years of regular, weekly, long (averaged 9 hours) playing sessions; the characters averaged 7th to 9th level and progressing, ever so slowly, toward tenth level. Realistically, a high level character is not necessarily all that much fun to play unless the campaign maintains a high level of challenge and adventure.

### EXPERIENCE POINTS AND THEIR APPLICATION

It is difficult to devise a point system by which a game master can judge and reward his players fairly. The ultimate purpose of experience points and experience levels is to provide a means by which the player's character can grow and develop. Many fantasy role-playing games have their own unique system, charts,



equations, and computations for distributing experience points. You may want to adapt one of these systems to this game if that's what you're comfortable with. Many games avoid the whole question of experience points by a system in which points are pumped back into the powers, but this leaves skills undeveloped, as well as being pretty drab.

The subjective method of observation and logic introduced in the **Palladium Role-Playing Game** has been so well received that I'm just transplanting it into **Beyond the Supernatural**. I feel that any twit can punch-out or blast a villain that just crawled out of the woodwork. Most experience systems concentrate on the "kill factor," but what about the thought process? What about the decisions, plans, or motives behind a particular action? Doesn't cleverness and a cool head count? Aren't these the true ingredients of good role-playing? Shouldn't the brilliant medical student playing a character with an I.Q. of 4 (and staying firmly in character, saying and doing things as the character would, even though he realizes the stupidity as a player) get experience for playing in character? Hell Yes!!! Considering how flexible and subjective most of the other role-playing conditions and rules are, I don't see the logic in having a strict, limited experience point system.

Each player's character involved in a given situation/confrontation should receive the appropriate experience points. The game master should make a list of his players at the beginning of the game and jot down each player's experience points as they gather them throughout the course of the game. At the end of the game, the game master totals each player's points and gives them the total so that they can keep track of their growing experience and skills.

The difficulty with this system of determining experience points is the subjectivity. The game master must utilize the proceeding experience outline with some thought. **Example:** Eight third level character's brimming with psychic power and armed to the teeth attack and subdue one, lone, fourth level villain or minor entity. The eight players should receive experience points for subduing a minor menace. After all, the poor guy didn't have a chance and presented no real threat to the characters. However, if one or two first or second level characters subdued the same villain, they should receive experience for subduing a major or even a great menace, because the threat and ingenuity involved are much greater.

I have found this method stimulates imaginative playing instead of promoting slash and kill. Game masters, don't be Santa Claus heaping wonderful amounts of experience points; be fair and tolerant. Let your players truly earn their experience points; growing in skill, knowledge and power. If you have a group of players rising rapidly in experience levels, you will know it's because they are clever and imaginative players. And that's what this game is all about!

### CHARACTER EXPERIENCE LEVELS

Each psychic character class has a listing for levels of experience. A character involved in an adventure gains experience points for his thoughts, actions and deeds. As these experience points accumulate, the character will reach new plateaus, indicating his continual growth, development, and mastery over his psychic power and skills. Each time a player's character accumulates enough experience points to reach the next level of experience, his skill increases accordingly. In many instances the super-

power also increases in range, duration, power/damage, and scope. **Example:** When a first level genius has accumulated at least 2051 experience points, he has attained second level, and *all* his scholastic and secondary skills become second level; meaning that he can perform them at a higher level of proficiency.

A clever plan, a quick attack, all earn experience points. The more experience points a character receives, the higher the level he attains and the greater his abilities. **Players**, be certain to keep a careful record of the experience given to you at the end of each game. When a character attains a new level, be certain to tell the game master so that the skills and hit points can be increased accordingly.

### EXPERIENCE AND HIT POINTS

Each time a character reaches a new level of experience the player gets to roll 1 six-sided die and adds the number rolled to the character's hit points. This indicates the physical development and maturity of the character as he develops.

### PER LEVEL OF EXPERIENCE

Per level of experience, or per each level of experience, or per level of the psychic, indicates that the person can perform a skill, psychic power, or ability at his highest level of experience. This often indicates the amount of damage that can be inflicted or a duration of an effect.

## EXPERIENCE POINTS TABLE

### Awarding Experience Points

Experience Points	Action
25	Performing a skill (successful or not).
25	Clever, but futile idea.
100	Clever, useful idea or action.
100	Quick-thinking idea or action.
200	A critical plan or action that saves the character's life and/or a few comrades.
400-1000	A critical plan or action that saves the entire group or many people.
100-300	Endangering the character's own life to help others.
500-700	Self-sacrifice (or potential self-sacrifice) in a <b>life and death</b> situation (like leaping in front of a fireball meant for someone else to save that person, even though he/she is likely to die, or offering his/her own life to save the group or another).
100	Avoiding unnecessary violence.
100-200	Deductive reasoning and/or insight.
50	Good judgment.
50	Playing in character bonus.
50-100	Daring (clever or not).
25-50	Killing or subduing a minor menace.
75-100	Killing or subduing a major menace.
150-300	Killing or subduing a great menace.



# EXPERIENCE LEVELS

Level of Experience Genius/Natural	
1	0000 – 2050
2	2051 – 4100
3	4101 – 8250
4	8251 – 16,500
5	16,501 – 24,600
6	24,601 – 34,700
7	34,701 – 49,800
8	49,801 – 69,900
9	69,901 – 95,000
10	95,001 – 130,100
11	130,101 – 180,200
12	180,201 – 230,300
13	230,301 – 280,400
14	280,401 – 340,500
15	340,501 – 400,600

Level of Experience Mage/Arcanist	
1	0000 – 2200
2	2201 – 4400
3	4401 – 8800
4	8801 – 17,700
5	17,701 – 25,700
6	25,701 – 35,700
7	35,701 – 50,700
8	50,701 – 70,700
9	70,701 – 95,700
10	95,701 – 135,700
11	135,701 – 185,700
12	185,701 – 225,700
13	225,701 – 275,700
14	275,701 – 325,700
15	325,701 – 385,000

Level of Experience Physical Psychic	
1	0000 – 2300
2	2301 – 4600
3	4601 – 9200
4	9201 – 18,400
5	18,401 – 26,800
6	26,801 – 36,900
7	36,901 – 51,100
8	51,101 – 71,200
9	71,201 – 96,300
10	96,301 – 136,400
11	136,401 – 186,500
12	186,501 – 236,600
13	236,601 – 286,700
14	286,701 – 336,800
15	336,801 – 396,900

Level of Experience Psychic Healer	
1	0000 – 2400
2	2401 – 4800
3	4801 – 9600
4	9601 – 19,000
5	19,001 – 27,000
6	27,001 – 37,000
7	37,001 – 52,000
8	52,001 – 72,000
9	72,001 – 96,000
10	96,001 – 131,000
11	131,001 – 180,000
12	180,001 – 229,000
13	229,001 – 278,000
14	278,001 – 337,000
15	337,001 – 396,000

Level of Experience Nega-Psychic	
1	0000 – 2000
2	2001 – 4000
3	4001 – 8200
4	8201 – 16,400
5	16,401 – 24,500
6	24,501 – 34,600
7	34,601 – 49,700
8	49,701 – 69,800
9	69,801 – 94,900
10	94,901 – 129,000
11	129,001 – 179,100
12	179,101 – 229,200
13	229,201 – 279,300
14	279,301 – 329,400
15	329,401 – 389,500

Level of Experience Psi-Mechanic	
1	0000 – 2140
2	2141 – 4280
3	4281 – 8560
4	8561 – 17,520
5	17,521 – 25,520
6	25,521 – 35,520
7	35,521 – 50,520
8	50,521 – 71,000
9	71,001 – 96,100
10	96,101 – 131,200
11	131,201 – 181,300
12	181,301 – 231,400
13	231,401 – 281,500
14	281,501 – 341,600
15	341,601 – 401,700

Level of Experience Latent Psychic	
1	0000 – 2100
2	2101 – 4200
3	4201 – 8400
4	8401 – 17,200
5	17,201 – 25,400
6	25,401 – 35,800
7	35,801 – 51,000
8	51,001 – 71,200
9	71,201 – 96,400
10	96,401 – 131,600
11	131,601 – 181,800
12	181,801 – 232,000
13	232,001 – 282,200
14	282,201 – 342,400
15	342,401 – 402,600

Level of Experience Parapsychologist	
1	0000 – 2120
2	2121 – 4240
3	4241 – 8480
4	8481 – 16,960
5	16,961 – 24,960
6	24,961 – 34,960
7	34,961 – 49,960
8	49,961 – 69,960
9	69,961 – 94,960
10	94,961 – 129,960
11	129,961 – 179,960
12	179,961 – 229,960
13	229,961 – 279,960
14	279,961 – 329,960
15	329,961 – 389,961

Level of Experience Psychic Sensitive	
1	0000 – 2240
2	2241 – 4480
3	4481 – 8960
4	8961 – 17,920
5	17,921 – 25,920
6	25,921 – 35,920
7	35,921 – 50,920
8	50,921 – 70,920
9	70,921 – 95,920
10	95,921 – 135,920
11	135,921 – 185,920
12	185,921 – 225,920
13	225,921 – 275,920
14	275,921 – 335,920
15	335,921 – 395,920

# INSANITY

In the context of this game, we will assume that all player characters are mentally and emotionally sound. Any insanities, developed from this point on, will be the result of trauma. A psychological trauma may result from a violent, emotional experience or shock. As psychic investigators, the characters will be somewhat prepared and hardened to frightening, unnatural or bizarre experiences. A trauma that will result in an insanity will have to be quite horrible.

## TRAUMA

I've found that having a character roll on the insanity tables after a terrible trauma is very appropriate, realistic and fun; adding a new element to the game. What constitutes a traumatic experience is, in part, up to the game master and the actual situation.

The following is a guide to some traumatic situations requiring a roll on the Random Insanity Tables.

### Long period of physical and/or mental torture.

Two to eight weeks: Roll once on the Insanity Table. Nine weeks to months: Roll once on the Insanity Table and once on the Neurosis Table.

**Drug Induced Hallucinations** that were particularly terrifying, hideous, or realistic.

Roll once on the Phobia Table. If extremely traumatic, lengthy, or reoccurring hallucinations, roll on the Random Insanity Table. A real life encounter with the subject of the traumatic hallucination is likely to cause more trauma. 70% chance of developing another insanity; roll on the Random Insanity Table.

### Witnessing or experiencing a shockingly grotesque atrocity.

Roll on the Phobia Table.

### Terrible, frightening or unusual brush with death.

Roll on the Random Insanity Table.

### Witnessing the terrible or shocking death of a deeply loved one.

Roll on the Psychosis Table.

### Severe physical disability.

60% chance of alcoholism or drug addiction.

**The cause (accidental) of several innocent peoples' deaths.** (applies to characters of a good alignment).

Roll on the Random Insanity Table.

## INSANITY TABLES

### RANDOM INSANITY TABLE

(Resulting from Trauma) Roll percentile dice.

- 1-10 **Reborn**; alignment reversal; good becomes evil, evil becomes good (selfish becomes principled or scrupulous).
- 11-20 **Neurosis**; roll on the table that follows.
- 21-25 **Compulsive Liar**; even if of a good alignment.
- 26-30 **Kleptomaniac**; a compulsion to steal, even if of a good alignment.
- 31-40 **Obsession**; roll on the table that follows.
- 41-50 **Phobia**; roll on the table that follows.

- 51-60 **Psychosis**; roll on the table that follows.
- 61-70 **Fear of Animals**; see neurosis.
- 71-80 **Recluse**; prefers to be alone, quiet, unobtrusive.
- 81-90 **Affective Disorder**; roll on the table that follows.
- 91-00 **Fear of the Dark**; see neurosis.

**Note:** More than one phobia, obsession, psychosis, or affective disorder is possible. If the same one is rolled, ignore it and roll again.

### RANDOM INSANITY TABLE (Optional)

- 1-19 Affective Disorders
- 20-45 Neurosis
- 46-65 Phobia
- 66-85 Obsession
- 86-00 Psychosis

### AFFECTIVE DISORDERS

- 1-19 **Frightened** by loud noises to the point of cowering and wetting self.
- 20-35 **Disgusted** by anything sticky, and will go to *any* length to avoid touching it.
- 36-54 **Obsessed** with cleanliness, and must clean up any area he/she is at for more than a few minutes.
- 55-75 **Outraged** by acts of violence, becoming violent himself; 72% chance of going berserk and attacking the perpetrator of the violent act without regard for self. Bonuses: +1 to strike, +2 to damage.
- 76-88 **Hates** music and musicians, and will try to destroy or stop the source of those terrible noises.
- 89-00 **Intimidated** by spoken language; cannot speak meaningful sentences, and must use sign language or written communication.

### NEUROSIS

- 1-18 **Fear of the Dark** (spent much time locked in closets) to the point of gibbering and total collapse while in the dark.
- 19-34 **Fear of Animals** (chewed on by the family pet while a nipper) to the point of running away when confronted by small, furry things.
- 35-49 **Cannot tell the Truth**; compulsive liar, even if of a good alignment.
- 50-64 **Invasion of the Body Snatchers**: Acute paranoia toward all supernatural entities, those of alien heritage and even humans born off the Earth. ("They're out to get ya! They could be anybody!! even . . . you!?!").
- 65-85 **Fear of Heights** (Uncle Goober used to dangle the character, by one foot, out of windows) to the point of being frozen above the second story; character is fine as long as ground is not visible.
- 86-00 **Fear of Success** (Mom always said you weren't any good): Character will sabotage self at critical moments. The following minuses apply during critical, or high pressure moments (battle, danger, watched by others, etc.): -15% to all skills, -3 to hit, dodge, parry and damage.

### PSYCHOSIS

- 1-15 **Hysterical Blindness** when under pressure, 1-89% likelihood of happening — roll for each situation.
- 16-28 **Paranoid type**; everyone is out to get you/trusts no one.



- 29-49 **Manic depressive**; alternate severe depression one week (suicidal, nobody loves you — -5% on all skills) with manic episodes the next week (everything is great and I'm the best that there ever was! — +5% on all skills). 30% chance of alcoholism.
- 50-73 **Schizophrenia**; you are passive and easily frightened; jumpy. You hear voices telling you that all the angels are dead; worry about what angels are. 50% chance of alcoholism or drug addiction.
- 74-85 **Mindless aggression**; roll percentile:
- 1-94 Semi-functional: When frustrated, angry, or upset, there is a 72% likelihood of going berserk and lashing out at anyone/everyone around until killed or confined; will take 3-18 minutes of confinement to regain composure.
- 95-00 Non-functional/homicidal: Continually going berserk until confined or killed; have one lucid day a week and try to talk your way out of confinement.
- 86-00 **Become a psychiatrist** and try to cure everyone around (they're all sick, even if only you have the perspicacity to tell); be sure to demand stiff fees.

## PHOBIAS

A phobia is an irrational fear which may result from a horrifying/traumatic experience. The object of the phobia can be anything: bugs, snakes, the dark, heights, flying, guns, typewriters . . . anything which may have been the focus or cause of the severe psychological trauma. While there are scientific names for specific phobias, it is far easier to simply identify the object of the phobia.

To determine a specific phobia, the player can roll on the *random table* which follows, or the game master and player can decide on a phobia which best applies to the severely traumatic experience. In the latter case, the determination of a phobia should be made on a common sense basis. **For Example:** If a character has had a horrifying experience in a haunted house, walked through spider webs, descended into a dark cellar and encountered a walking skeleton; one of the following phobias could easily apply, fear of empty old houses, fear of the dark, fear of spiders or insects, of cellars, of corpses, etc.

**G.M. Note:** Dealing with the supernatural will constantly send characters into scary, horrifying, bizarre and deadly situations. But it is only the most horrifying and unexpected experiences that *may* create a phobia or other insanity. Remember, the characters will be prepared and hardened to sights, concepts and creatures that might bedazzle the mind of a normal, unsuspecting person.

### Phobic Panic

The character who suffers from a phobia will become terrified when the object of fear is encountered. If the character is surrounded by friends who can talk and soothe away his fears, the person may be able to contain himself long enough to safely avoid it (40% chance). However, if the character is alone, already nervous or feels threatened, he or she will be overcome by fear. This is a phobic panic.

Upon reaching the breaking point, the character's mind will defend itself by causing the character to respond in one of the following ways. (Roll percentile dice).

- 1-25 Pass Out/Fall unconscious for 2 to 8 minutes (roll 2D4).
- 26-80 Flee/run away at top speed. Panic-stricken, the character will ignore the outcry, pleas or needs of his companions. All the terrified person knows is that he or she must escape. The character will run and run until he is certain he's escaped the object of his fear, or until subdued. The person will fight only if there is no other way to escape and then only until he/she can get away and run.
- 81-00 Paralyzed with fear, the character can only cry, whimper or scream. Physically, the character will stand completely rigid or huddled in a corner, immobilized with fear. He/she can *not* run, use skills, fight or move in any way (no attacks per melee), until the object of the fear is removed or destroyed, or he is dragged away from it.

## PHOBIAS (A deep, overriding fear)

- 1-3 Undead  
4-6 Reptiles  
7-9 Scientists  
10-12 Mutants  
13-15 Snakes  
16-19 Ghosts  
20-22 Confining Enclosures  
23-26 Skeletons  
27-29 Darkness  
30-32 Graveyards/Burial Mounds  
33-35 Abandoned Old Houses/Buildings  
36-39 Giant Creatures/Monsters  
40-44 Basements/Cellars  
45-48 Corpses  
49-51 Users of Magic  
52-54 Spiders  
55-57 Tombs  
58-61 Cats  
62-64 Heights  
65-67 Dogs  
68-70 Contamination  
71-73 Psychic Strangers  
74-77 Insects  
78-80 Flying  
81-84 Bats/Bat-Like Things  
85-87 Water  
88-90 Computers  
91-93 Psychic Healing  
94-96 Open Spaces  
97-00 Supernatural Entities

**Note:** If the same phobia is rolled, the player must re-roll.

## OBSESSIONS

Obsessions are either an intense, irrational love/desire of something, or an intense hatred/loathing. The former is likely to cause the obsessed person to obtain his desire, while the latter is likely to cause the obsessed person to avoid or destroy the object of his obsession. *The game master* can decide which is most appropriate under the circumstances or roll once on the following table . . .

### Focus of the Obsession

- 1-50 Love/Desire  
51-00 Hate/Destroy



## Obsessions

- 1-5 Timeliness (either a fanatic about being punctual or always late).
- 6-12 High technology (either loves to acquire/use or loathes it).
- 13-20 Women (or men, if a woman character)
- 21-27 Wealth
- 28-35 Secrecy (either prizes his secrecy above all else, or abhors even the thought of keeping secrets).
- 36-43 Specific individual.
- 44-50 Specific object/item or animal.
- 51-55 Appearance (fashion plate or slob).
- 56-63 Danger (either loves the thrill of danger, which usually means throwing caution to the wind, the more deadly the better; or, despises danger, overly cautious, worry wart, jumpy).
- 64-70 Food (covets only the finest foods and drink, or would, just as readily, eat worms and stale food as anything else; a slob).
- 71-78 Alcohol (either a heavy drinker with a keen taste for the finest liquor, or a fanatical, anti-alcohol prude).
- 79-86 Gambling (will bet it all, or an anti-gambling fanatic).
- 87-92 Solitude (either loves quiet and being alone to the point of growing irrationally angry and frustrated if continually bothered or interrupted; or can't stand the thought of being left alone for even short periods of time).
- 93-00 Crime-busting: Loves it if a hero; obsessed with stomping out crime and evil everywhere. If a villain "crime lord". Loves the thrill of being a criminal mastermind.

**Note:** This insanity may drive a character to incredible (even outrageous) lengths, to satisfy his or her obsession.

## CURES FOR INSANITY

**Affective Disorder or Neurosis:** Therapy and counseling, and/or the use of hypnosis. Requires a minimum of three months of therapy, with the following results:

- 1-29 No effect; requires another three months of therapy.
- 30-69 Half cured; person feels occasional return of old neurosis or disorder when under stress, 48% chance.
- 70-00 Total cure.

**Psychosis:** Therapy and possible use of hypnosis and drugs to control the moods and tension/stress. Requires a minimum of six months of therapy, with the following results:

- 1-33 No effect; requires another six months of therapy.
- 34-68 Psychosis replaced by phobia.
- 69-00 Total cure.

**Phobia:** There is no cure for phobias, but prolonged or repeated exposure to the object of the fear will lessen the intensity of the fear. Requires a minimum of three months of therapy, with the following results:

- 1-39 No effect; requires more therapy.
- 40-88 Fear is lessened so that the person can function normally, but he/she still doesn't like the phobia object — ugh!
- 89-00 Fear is intensified so that there is a 50% likelihood that the person will become completely paralyzed until the source of the fear is removed, or the person is physically removed.

Therapy sessions generally cost \$75 each, with two sessions per week (this includes treatment for each category of insanity). Similar therapy can help obsessions.

## EFFECTS OF ALCOHOLISM

### (Roll for effects and disposition while intoxicated)

- 1-10 Mean, hostile, strong; +2 to damage.
- 11-20 Quick temper, argumentative; +1 on initiative, -1 to parry or dodge.
- 21-30 Impulsive, takes risks; +2 on initiative.
- 31-40 Quiet, withdrawn; -2% on all skills.
- 41-50 Paranoid, trusts no one, agitated; +1 on initiative.
- 51-60 Moody, sad; -5% on all skills.
- 61-70 Secure/self-assured only while intoxicated; -2% on all skills when sober.
- 71-80 Depressed, pessimistic; -5% on all skills.
- 81-90 Hyper, agitated, always moving, distracted; -2 on initiative.
- 91-00 Super syndrome; believes he/she is best when intoxicated. +5% on all skills when intoxicated, -10% when sober.

### Totally Drunk (staggering)

The alcoholic is in a totally drunken state 25% of the time (intoxicated as often as possible — 80% of the time), and tends to drink even more during a crisis — 50% of the time.

### When totally drunk, the following penalties apply:

- -4 on initiative.
- -2 to strike, parry and dodge.
- Reduce speed by half.
- Reduce *all* skills by 12%

**Alcoholism can be cured**, and requires willingness to seek aid, abstinence from all alcohol, therapy and support of friends.

### Withdrawal Symptoms:

**First Week:** -5% on all skills, -2 on initiative, strike, parry and dodge. Very sick, shaky, insecure. 40% chance will go back to drinking.

**Second Week:** -2% on all skills, -2 on initiative; -1 to strike, parry and dodge. Still shaky, insecure, craves alcohol. 20% chance will fall back to drinking. Roll for both weeks.

**Third through Sixth Week:** -2 on initiative. Still shaky, insecure, but feeling more confident. 13% chance will fall back to drinking. Roll for each week.

**The next six months:** Now it's a battle to stay dry; 15% chance the character will return to alcohol under extreme pressure. Roll for each pressure situation, such as near death (of self or friend), major failure, crucial situation relying heavily or entirely on the person, etc.

**After those six months:** There is still a possibility of returning to drink when under extreme pressure, as explained above; 5% in a crisis. If the ex-alcoholic should ever drink alcohol again, there is a 43% likelihood of becoming addicted again. Roll for each *drink*. Note: A character can attempt to fight alcoholism repeatedly, regardless of numerous failures.

## THE EFFECTS OF DRUG ADDICTION

Drug addiction is generally more severe in its effects and initial withdrawal symptoms. However, once detoxified/dry, the person is less likely to return to drugs than an alcoholic. Most references to drug addiction refers to hard drugs, such as L.S.D., heroin, P.C.P., barbiturates (downers), amphetamines (speed), cocaine derivatives, and mood altering drugs.



### Roll for effects and disposition while intoxicated

- 1-10 Quick temper, argumentative; +1 on initiative.  
11-20 Totally passive, will *not* attack, confused, wants to be left alone. -5 to parry, dodge, and roll with punch or fall.  
21-30 Extremely paranoid. Trusts no one, not even friends; +1 on initiative.  
31-40 Disoriented. Has difficulty following movement; -4 to parry and dodge, -2 to strike.  
41-50 Hallucinations. Totally oblivious to reality; -4 to parry and dodge, 50% chance of not recognizing friend or foe, or attacking a friend (thinking him an enemy), or not recognizing danger, or cringe in terror of battle phantoms.  
51-60 Withdrawn, quiet; -6% on all skills.  
61-70 Secure/self-assured only while high; -4% on all skills when not on drugs.  
71-80 Depressed, pessimistic; -8% on all skills.  
81-85 Reoccurring hallucinations when under severe pressure/combat. 43% chance of reoccurrence/flash-back, same as hallucination listed previously.  
86-91 Hyper, agitated, always moving, distracted; -2 on initiative, -2% on all skills.  
92-00 Super syndrome; believes his abilities are heightened by drugs; +1 to strike, parry and dodge; +6% on all skills when high. -1 to strike, parry and dodge; -12% on all skills when straight (not on a drug-high).

### General notes concerning drugs:

- Takes 15 to 20 minutes to take effect.
- Effects last 45 minutes to two hours.
- Remains in system, even after the high is gone, for 48 hours.
- Addicts *need* a continual supply, taken at least once or twice a day (or more often, depending on the drug and desired effects).

**Drug addiction can be cured**, and requires a willingness to seek treatment and being slowly weaned off its dependency by gradual substitutes. Total withdrawal, or going "cold turkey," is the sudden abstinence from any drugs.

### Withdrawal Symptoms (cold turkey)

**First Week:** -35% on all skills, -8 on all combat skills, violently ill: nausea, vomiting, cramps, etc. Requires regular observation and facilities. 75% likelihood of taking the drug if it's available.

**Second Week:** -20% on all skills, -4 on all combat skills, very weak, shaky, nauseated. 50% chance of taking the drug if it's available.

**Third Week:** -10% on all skills, -2 to strike, parry and dodge. Weak and insecure, but feeling considerably better. 28% chance of taking the drug if available.

**Fourth Week:** Completely detoxified, only psychological addiction remains. 14% chance of taking the drug if made available. Suggest continued therapy/counseling.

**The next six months:** This is the battle to stay dry. 10% chance will return to drugs if under extreme pressure.

**After those six months:** There is little chance of turning to drugs, even under pressure; 3% chance.

**Note:** A character can attempt to fight addiction repeatedly, despite numerous failures to do so.

## OPTIONAL RULES

### Optional Ways to Round Out Your Character

I've found that many players like as much background and details about their characters as possible. Consequently, I've assembled a series of optional tables to satisfy those details. All tables require the roll of percentile dice.

### Birth Order

- 1-30 First Born  
31-44 Second Born  
45-55 Third Born  
56-65 Fourth Born  
66-80 Last Born  
81-90 First Born of Twins  
91-00 Illegitimate

### Weight

- 1-10 Skinny  
11-30 Thin  
31-55 Average  
56-74 Husky  
75-89 Potbelly  
90-00 Obese

**Note:** Average Weight:  
150 to 180lbs (male)  
110 to 140lbs (female)

### Height

- 1-30 Short  
31-70 Average  
71-00 Tall

**Note:** Average Height:  
6ft, male  
5ft 6in, female

### Age

I think it is best to generally assume most characters are young — late teens to mid-twenties. It is best to determine the age by the level of the character's education and player preference.

### Disposition

- 1-10 Mean, suspicious, vengeful.  
11-15 Shy, timid, tends to be a loner.  
16-20 Gung-ho, guts and glory type who sees himself as a hero. Likes combat.  
21-25 Worry wart, nervous and cautious.  
26-37 Hot-head, quick-tempered, emotional, but basically nice.  
38-45 Schemer; gambler who likes to take chances.  
46-50 Blabber-mouth, nice guy, but too talkative.  
51-56 Wild man, cocky, overconfident, takes unnecessary risks.  
57-66 Nice guy, friendly, courteous and hospitable.  
67-76 Snob, arrogant, feels superior to others.  
77-84 Tough guy, self-reliant, cocky, a lone wolf.  
85-89 Paternal, overbearing, overprotective of others, especially young characters.  
90-94 Complainer, constantly aggravated about something.  
95-00 Paranoid, trusts no one.



## CHARACTER BACKGROUND (Optional)



N. O'Connor & S.R. BISSETT

A desire for a profession as a supernatural investigator or psychic isn't exactly normal. And the reasons why the character would get into this strange and antisocial kind of work can sometimes be pretty interesting in and of itself. After all, the vast majority of people with latent psychic powers never actually do anything about them. Roll on the following table to round out the character's background.

- 1-25 Just Curious:** The character is an enthusiastic and lifelong student of the supernatural. As a youngster, the character avidly read and collected used books and magazines on the subject. Every story of a UFO sighting, a haunted house, or a mysterious killing, seemed fascinating. The character is still more intrigued than frightened by most aspects of the arcane.
- 26-35 Witness to the Supernatural:** At some point, in the character's teenage years, he or she was witness to a major supernatural event. Ever since then the character has been interested in discovering more.
- 36-40 Traumatic Change:** At some point the character's outlook was drastically different. From a complete disbelief, or ignorance, of the supernatural, the character has become obsessed with the phenomena. This was caused by a traumatic exposure to a supernatural event in recent years.

- 41-50 Haunted:** For some reason, ever since the character was a child, ghosts have always shown up whenever he was around. Some mysterious quality about the character just naturally makes ghosts curious, neither harmful or hurtful, just curious.
- 51-55 Formerly Insane:** At one time the character was institutionalized for a severe mental problem caused by an encounter with the supernatural he/she can *not* remember. Roll on Insanity Tables. There is a remote chance that, under severe stress, the character may revert.
- 56-60 Former Drug Addict/Alcoholic:** Character used to be an addict or an alcoholic and has since reformed. Under severe pressure the character *may* fall off the wagon.
- 61-65 Befriended by Mystic:** Early in the character's life, a mystic (actually a Psychic Sensitive) identified his/her powers. Although the mystic has since disappeared, the character still remembers.
- 66-70 Befriended by Ghost:** The character has a "Spirit Guide" on the astral plane. For some reason the ghost has been following the character around since childhood, and will do whatever it can to help the character. Unfortunately, the ghost has no real power, and can't even communicate unless the character is capable of some kind of psychic communications (telepathy or empathy) or uses Astral Projection. Note that even a non-psychic or nega-psychic can have a Ghost, they'll just be *unaware* of its presence.
- 71-75 Fraud Artist:** In earlier years the character earned money as a "psychic" — not because of any real psychic talent, but because it was an easy way to defraud gullible people out of their money. Since then, the character has discovered that the supernatural really exists. The character is now contemptuous of charlatans who use psychic fakery.
- 76-80 Shaman:** The character originally learned about the occult in another culture and was trained as a shaman. A few of the possible cultures include American Indian, African, Hindu, or Australian Aborigine. The character will automatically have fluency in the language of her native culture as well as English.
- 81-85 Magician:** The character was once a student of stage magic and learned to do a variety of tricks. The character must choose skills normally, but will receive a +10% bonus on any related skills chosen, especially Sleight of Hand, Escape Artist, Palming and the like.
- 86-90 Driven:** A wide-eyed fanatic on the subject of the supernatural, the character is constantly trying to convince others that the ghosts and ghoulies actually exist.
- 91-95 Psychic Relative:** An older relative of the character is of the same P.C.C. as the character. The relative will be 1D6 times 10 older than the character and still alive. Although the relative is not a full-time psychic investigator, she (or he) will have quite a few years of experience that can be shared with the character occasionally. In practice, the relative can occasionally give the character a "hint" about how to solve a particular problem.
- 96-00 Psychic Family:** Everyone in the character's family is the equivalent of a P.C.C. Note that they're also prone to instability, about 70% of them will have one or more Insanities.



## Family History of Psychic Phenomena

- 1-16 Grandmother was known to sense disasters and had prophetic dreams, but nobody else.
- 17-34 None. Nobody ever remembers anybody in the family with psychic abilities.
- 35-50 Some, but nothing special; the usual little flashes of hunches, luck and intuitive feelings.
- 51-65 A long history of psychic phenomena dating back 2D4 generations, that are known. Abilities are said to include total recall, speed reading, see the invisible ("Great Grandad swore he could see ghosts."), divination ("Cousin Sue could read tea leaves and palms like you read a newspaper."), bio-manipulation ("They say Great Aunt Betsy had the evil eye.") and clairvoyant flashes (prophetic dreams, visions and feelings).
- 66-82 No history of psychic phenomena, but one of the grandparent's relatives was said to have dabbled in magic.
- 83-00 No recent history of psychic phenomena in the last two or three generations, but a distant relative or several relatives were "known" to have unusual powers. This means the person was a shaman, healer, seer, magician, holy person, witch, prophet, or similarly regarded person in the community.

## Type of Environment

- 1-20 Agricultural/Farm Community
- 21-40 Countryside, small town or village
- 41-60 Suburb, small city or large town
- 61-85 Large City (New York, Los Angeles, Detroit, Toronto, London)
- 86-00 City — Medium Size

## Social/Economic Background

- 1-9 Military/Middle Class
- 10-19 Laborer/Poor
- 20-29 Laborer/Lower Class
- 30-59 Laborer/Middle Class
- 60-74 Skilled/Middle Class
- 75-84 Highly Skilled/Upper Middle to Upper Class
- 85-89 Political/Upper Middle Class
- 90-00 Wealthy

## Land of Origin

- 1-10 Australia
- 11-20 Europe; Great Britain
- 21-51 United States
- 52-68 Canada
- 69-80 Europe; Non-English speaking
- 81-90 South America
- 91-00 Asia/Middle East

**Note:** Characters of a non-english speaking ethnic background can speak and understand that one additional language at 75% efficiency, but can not read the language. Add 30% to foreign language skill if that language is studied. It is best to assume that the psychic beings live and work in the country of the players. Our foreign friends will want to adjust this table, replacing the U.S. with their own country and Canada with their foreign neighbors.

## When Special Ability First Manifested Itself

- 1-11 Child
- 12-29 Preteen
- 30-50 Early Teens
- 51-74 Late Teens
- 75-00 Recently

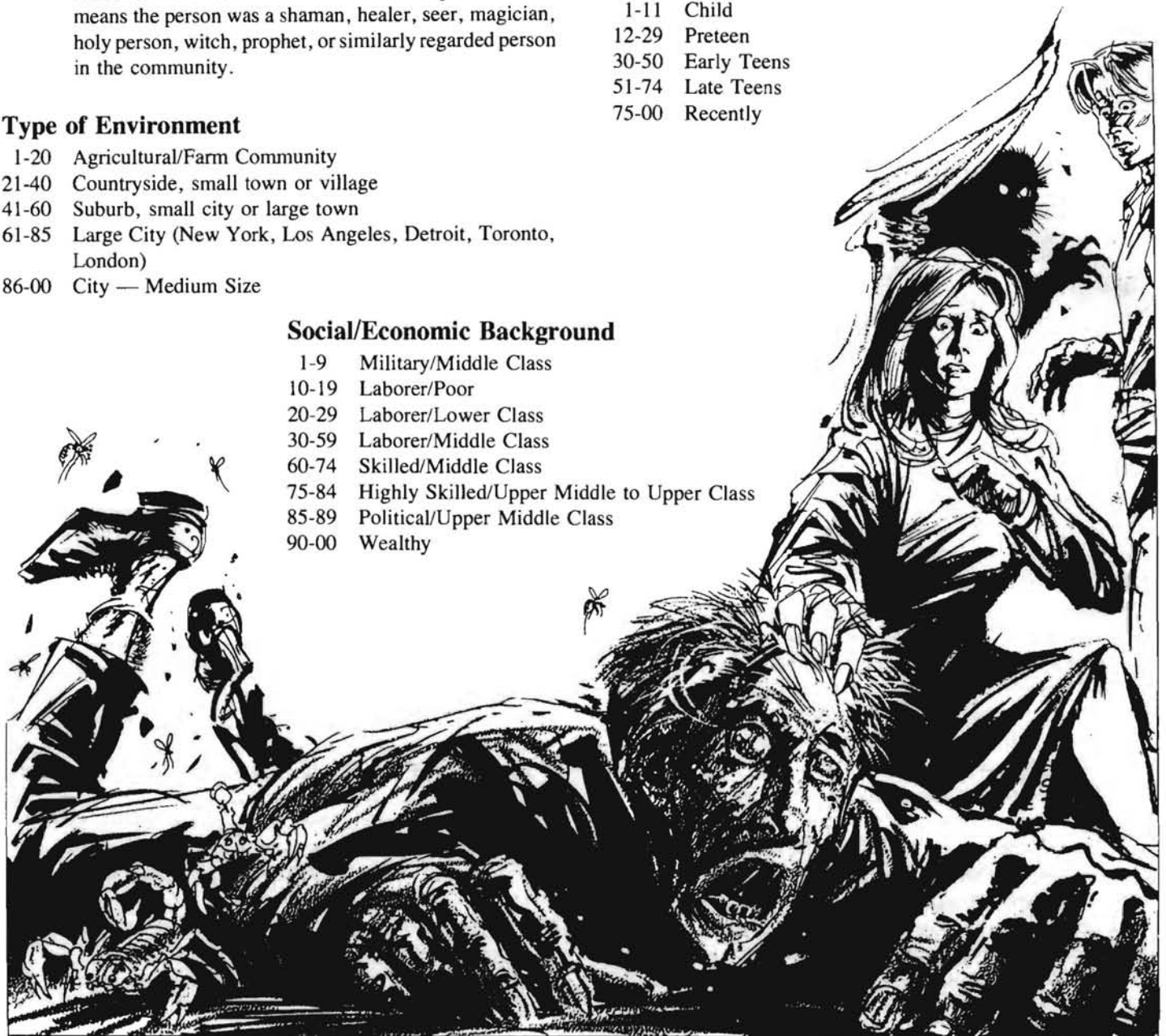



# EDUCATION AND SKILLS

As always, the selection of skills is very important in developing and rounding out your character. It is here, with skills, that you can dictate just how knowledgeable or physically capable your character is. An emphasis on physical skills can create a strong, tough, athletic character, while a selection of other skills can create investigative reporters, detectives, doctors, electrical engineers and so on. Be certain to review all the skills and skill programs to mold the type of character you want.

## DETERMINING EDUCATIONAL LEVEL

The *Educational Level* reflects the character's years and intensity of study. This is directly translated to the educational bonus and the number of skill programs a character can select. The one time bonus is applied to ALL *scholastic skills*. Do not add this bonus to secondary skills.

**Scholastic Skills** are skills learned through formal education, whether it be high school, college, military or on the job training.

**Secondary Skills** are skills learned and developed on one's own through observation, practice and self-education.

**IMPORTANT NOTE:** Characters who fall into the psychic character class of parapsychologist and mage/arcanist do NOT roll on the Educational Level Table. Instead, go to the P.C.C. power section to see how special skills and training are selected.

## EDUCATIONAL LEVEL

*Roll Percentile Dice*

- 01-09 High School Graduate:** Bonus +5%; select 2 skill programs and 10 secondary skills.
- 10-18 Military:** Bonus +10%; select 2 skill programs and 8 secondary skills, plus W.P. Automatic Rifle and Hand to Hand: Basic.
- 19-27 Trade School or On The Job Training:** Bonus +10%; select 2 skill programs and 8 secondary skills.
- 28-36 One Year of College:** Bonus +10%; select 2 skill programs and 8 secondary skills.
- 37-45 Two Years of College:** Bonus +10%; select 2 skill programs and 8 secondary skills.
- 46-54 Three Years of College:** Bonus +10%; select 3 skill programs and 8 secondary skills.
- 55-63 Four Years of College:** Bonus +15%; select 3 skill programs and 10 secondary skills.
- 64-72 Military Specialist:** Bonus +15%; select 6 skills from the *Espionage* skill program and 4 from the *Weapon Proficiencies (W.P.)* program, plus ONE other skill program, 6 more from W.P., and 8 secondary skills.
- 73-81 Bachelor's Degree (College):** Bonus +20%; select 3 skill programs and 10 secondary skills.
- 82-90 Master's Degree (College):** Bonus +25%; select 3 skill programs and 10 secondary skills.
- 91-00 Doctorate or Ph.D (College):** Bonus +30%; select 4 skill programs and 10 secondary skills.

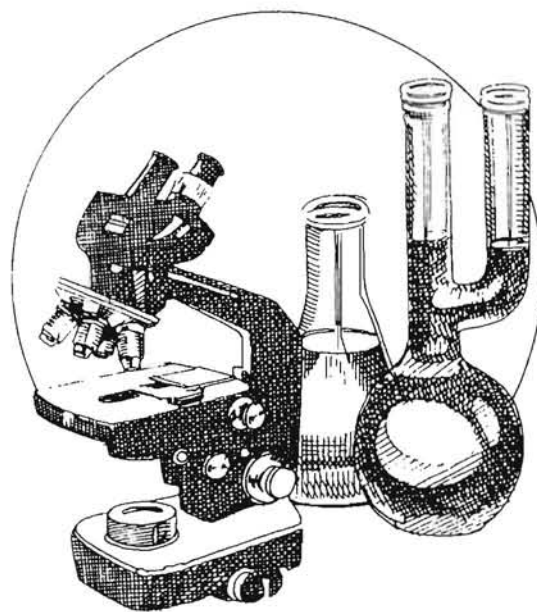

## SKILL PROGRAMS (Scholastic Skills)

A skill program is an area of study, training and knowledge attained from formal education. ALL the skills listed under the program heading are known. Apply the *educational bonus* to each. See the individual *skill descriptions* for exact details regarding each skill ability.

**Special Restrictions:** 1) Espionage Skills are limited to the educational levels of *Military Specialist* and *Trade School* (specialized training) and can NOT be selected by any other education levels. 2) The Military Specialist is the only educational level that automatically selects six Espionage Skills and can select the Espionage Program to get additional training, for a total of 12 espionage skills. 3) Only ONE hand to hand combat skill can be selected. In cases where more than one type is available, the player must select only one and disregard the others. 4) Medical Doctor is limited to characters who have achieved the educational level of *Master's* (spent years of study, although NOT a legal, practicing doctor) and *Doctorate/Ph.D.* (a legal, full-fledged doctor). Characters with less education must settle for paramedic. First Aid is available as a secondary skill. *Note:* The Science Program must also be selected to be a M.D. 5) Advanced Piloting skills are available only to Military, Military Specialist, Trade School (specialized training program) and Doctorate/Ph.D. Educational Levels. 6) The Military Skill Program is limited to the Military, Military Specialist and Trade School (specialized training) educational levels. 7) The Stage Magic Skill Program is available *only* to the educational level of *Trade School or On The Job Training*. No other character can select stage magic skills. 8) High School Educational Level can only select from the following skill programs: Computer, Domestic, Physical, Language, Technical and W.P. Ancient. 9) A Skill Program can be selected only ONCE unless otherwise stated.



## AVAILABLE SKILL PROGRAMS

Select as many skill programs as allowed by your character's Educational Level; usually 2 or 3 programs. Remember to add the educational skill bonus to each of these *Scholastic Skills*.

### Automatic Skills

(known by all characters)

Mathematics: Basic  
Read/Write Native Language  
Speaks Native Language

### Communications Program

Cryptography  
Laser  
Optic Systems  
Radio: Basic  
Radio: Scrambler  
Radio: Satellite  
T.V./Video  
Read Sensory Equipment

### Computer Program

Computer Operation  
Computer Programming

### Domestic Program

Select three

### Electrical Program

Electrical Engineer  
Surveillance Systems  
Computer Repair  
Computer Operation or T.V. Video or Computer Programming  
(select one of the three)

### \*Espionage Program

Select Six

### Journalist/Investigation Program

Computer Operation  
Intelligence  
Photography  
Research  
Writing (Journalistic Style)

### Language

Select Three

### Mechanical Program

Mechanical Engineer  
Locksmith  
Automotive *or* Aircraft  
*or* Computer Repair (pick one of the three)

### Medical Program

Biology  
Criminal Science/Forensics  
Paramedic  
Pathology  
\*Medical Doctor (conditional)

### \*Military Program

Hand to Hand Basic  
Demolition  
Demolition Disposal  
Pilot Tank  
Read Sensory Equipment

### \*Pilot Advanced Program

Navigation: Space  
Navigation (Air, Land, Water)  
Read Sensory Equipment  
Weapon Systems  
Pilot: Select two aircraft from advanced pilot list.  
**Note:** Pilot Basic — see secondary skills.

### Physical Program

Select Four

### Science Program

Computer Operation  
Select Five

### Stage Magic

Select Five

### Technical Program

Select Five, excluding language.

### Weapon Proficiencies (W.P.)

#### W.P. Ancient Weapons Program

Select Three

#### W.P. Modern Weapons Program

Select Three

\*Availability is restricted. See *Special Restrictions before selecting*.

## A FEW NOTES ABOUT SKILLS

### **Can you have a 100% or higher skill proficiency?**

No! The maximum possible skill proficiency is 98%. There is always a margin for error.

### **How do you learn more skills?**

A player may select TWO, new, *secondary skills* at levels 3, 6, 9, 12 and 15. All new skills begin at first level proficiency and grow as the character grows in experience.

### **Can a character go back to school to learn or improve his skills?**

Yes. However, this is very difficult for a character to do. Why? Because he or she spends so much time and energy ghost hunting, they usually don't have the time to properly devote to scholastic pursuits.

To learn a new scholastic skill (one) or a skill program (several) the character must attend college. This will require money for class, time spent at classes and time spent on homework. The game master should logically assign *time requirements for each*. A good rule of thumb is 4 to 6 hours a week in class (regular hours — not at the psychic's discretion) per *each* subject/skill, and another 6 to 8 hours per week spent on homework and study per *each* subject/skill. Three missed assignments or three ab-



sences from classes means a flunking grade. NO skill, NO skill bonus and no refund of tuition. You may try again.

*Successful scholastic studies* means three completed semesters (1½ school years) of passing grades in that area(s) of study. The skill is now known at its "base skill" proficiency. *Skill bonus* is +5% for every three semesters of passed class (total possible is 12 semesters, for a combined *total* bonus of +20%). As you may have noticed, the skill bonus is not as great or as quickly attained as the original skill bonus from the educational level table.

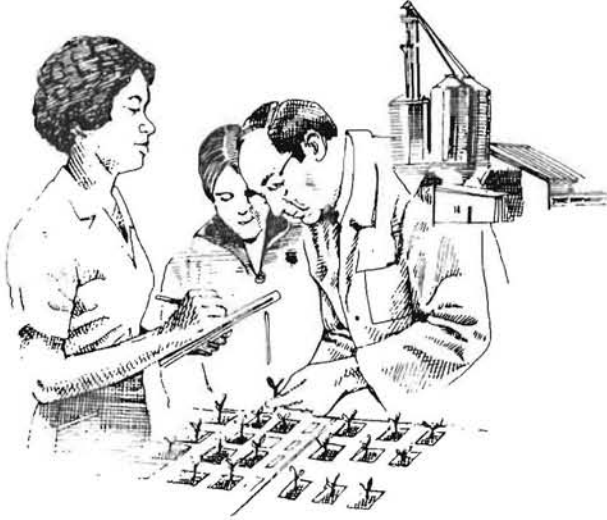

*The cost of education* varies with the individual college and intensity of study. The following are reasonable prices per each semester and per each individual skill. This means a skill program with three skills will cost three times as much and require three times as much time.

Community College: Costs \$200 per each skill for one semester of study. The educational standards are less demanding, so there is a *skill penalty* of -5% for each skill.

College or University: Costs \$500 per each skill for one semester of study.

College or University with a reputation for quality and scholastic excellence: Costs \$1200 per each skill for a semester of study, and will require twice as much time in class and study.

**Note:** +20% skill bonus is the maximum possible.

#### **Are physical skill bonuses accumulative?**

Yes. The player should decide what areas of physical strength and prowess are most important to his/her character and select the appropriate skills to bolster those areas. Physical attributes (P.S., P.P., P.E. Spd.), S.D.C., and combat bonuses to strike, parry, dodge and roll, are often provided by a particular physical skill. ALL such pluses and bonuses are accumulative. For Example: A player has a character with a P.S. of 13, but would like his/her hero to be stronger. Boxing is selected, adding +1D4 to the P.S. (a 2 is rolled). Body building is also selected for +2 P.S., and Wrestling for another +2 P.S., and gymnastics for yet another +2 P.S. The accumulated P.S. bonuses amount to a +8 P.S., which is added to the original P.S. of 13. *Total P.S. is now 21!!* The same is done with the other attribute, S.D.C. and combat bonuses.

*Acrobatics and gymnastics* provide similar abilities and bonuses. If *both* are selected, add the bonuses and pluses to your overall character as just explained. However, the abilities such

as back flip, climb rope, etc., are NOT added together, nor is the educational bonus added twice (once for each; wrong). The best skill proficiency of a duplicated skill is taken and the normal educational skill bonus is applied.

#### **How many hand to hand skills can be selected?**

*Only One.* The hand to hand skill will, however, add to the total number of attacks per melee and combat bonuses to strike, parry, dodge and roll.

## SECONDARY SKILLS

Secondary skills are skills learned and developed on one's own through observation, practice and self education. Some skills can be found under both the scholastic skill programs and secondary skill list, such as computer operation and photography. In these cases, the skill is basically the same, however, the *educational bonus* CAN NOT be applied to the secondary skill. Secondary skills get no bonuses (except possibly, I.Q. attribute bonus). Furthermore, you can NOT choose the same skill twice to get multiple bonuses or increased proficiencies. This is true even if it is available twice through different skill programs or again as a secondary skill.

The main difference between identical scholastic and secondary skills is the degree of knowledge and level of proficiency. A scholastic skill is considered to be at a professional or near-professional level or quality. A cook or photographer with scholastic skills/professional education are of a commercial, professional quality. The same skills selected as secondary means the quality is fairly competent, it does the job, and may even show great talent, but it is NOT of professional, commercial quality. This is true even if the secondary skill's percentage number is higher than somebody's same scholastic skill. Scholastic skills are always of superior quality with a greater range of knowledge. A higher secondary skill percentile will mean that experience has compensated for formal training.

## SECONDARY SKILL LIST

**Note:** Do not add educational skill bonuses to any of the secondary skills selected. Secondary skills are selected in addition to scholastic skills.

### **Computer**

Computer Operation

### **Domestic**

Cook  
Dance  
Fish  
Sew  
Sing

### **Electrical**

Basic Electronics

### **Espionage Type (thief)**

Escape Artist  
Forgery  
Land Navigation  
Pick Locks  
Pick Pockets  
Wilderness Survival



## **Mechanical**

Basic Mechanics  
Auto Mechanics

## **Medical**

First Aid

## **Physical**

Hand to Hand: Basic  
Hand to Hand: Martial Arts  
Athletics (general)  
Body Building  
Climbing  
Prowl  
Running  
Swimming

## **Pilot: Basic**

Automobile  
Race Car  
Truck  
Motorcycle  
Airplane; old style, single or twin engine  
Helicopter  
Boats: Sail  
Boats: Motor

## **Pilot Related Skills**

Navigation (air, land, water)  
Read Sensory Instruments

## **Science**

Advanced Mathematics  
Astronomy

## **Technical**

History  
Art  
Language  
Photography  
Research  
Writing

## **W.P. Ancient Weapons**

W.P. Blunt  
W.P. Chain  
W.P. Knife

## **W.P. Modern Weapons**

W.P. Revolver  
W.P. Automatic Pistol  
W.P. Rifle  
W.P. Sub-Machinegun

\*Hand to Hand: Martial Arts and Pilot: Helicopter each count as two skill selections.

# **SCHOLASTIC SKILLS LISTED BY CATEGORY**

## **COMMUNICATIONS**

Cryptography  
Laser

Optic Systems  
Radio: Basic  
Radio: Scrambler  
Radio: Satellite  
Surveillance  
T.V./Video

**Note:** Read Sensory Instruments is found under Pilot related skills.

## **COMPUTER**

Computer Operation  
Computer Programming

## **DOMESTIC**

Cook  
Dance  
Fish  
Sew  
Sing

## **ELECTRICAL**

Basic Electronics  
Electrical Engineer

## **ESPIONAGE**

Concealment  
Detect Ambush  
Detect Concealment  
Disguise  
Escape Artist  
Forgery  
Intelligence  
Impersonation  
Interrogation  
Land Navigation  
Palming  
Pick Locks  
Pick Pockets  
Sniper  
Tracking  
Wilderness Survival

## **MECHANICAL**

Automotive Mechanics  
Aircraft Mechanics  
Basic Mechanics  
Computer Repair  
Locksmith  
Mechanical Engineering

## **MEDICAL**

Criminal Science/Forensics  
First Aid  
Medical Doctor  
Paramedic  
Pathology



## MILITARY

Demolitions  
Demolitions Disposal  
Pilot Tank

## PHYSICAL

Hand to Hand Basic  
Hand to Hand Expert  
Hand to Hand Martial Arts  
Acrobatics  
Archery  
Athletics (general)  
Body Building  
Boxing  
Climbing  
Fencing  
Gymnastics  
Prowl  
Running  
Swimming  
Swimming, Advanced  
Wrestling

## PILOT BASIC (Ground, Air and Water) (Secondary Skills)

Automobile  
Race Car  
Motorcycle  
Truck  
Airplane; old style, single or twin engine.  
Boats: Sail  
Boats: Motor

## PILOT, ADVANCED

Helicopter, Basic  
Helicopter, Combat  
Jet  
Jet Fighter  
Space Shuttle

## PILOT RELATED SKILLS

Navigation (Air, Land, Water)  
Navigation: Space  
Read Sensory Instruments  
Weapon Systems (missiles, lasers, etc.)

## SCIENCE

Anthropology  
Archaeology  
Astronomy  
Astrophysics  
Biology  
Botany  
Chemistry  
Chemistry: Analytical  
Chemistry: Pharmaceutical  
Mathematics: Basic  
Mathematics: Advanced  
Psychology  
Psychotherapy

**Note:** Computer is found under Computer.

## STAGE MAGIC

Concealment  
Detect Concealment  
Disguise  
Escape Artist  
Palming  
Pick Locks  
Pick Pockets  
Sleight of Hand  
Contortionist  
Juggling

## TECHNICAL

Art  
History  
Journalism  
Language  
Lore: Demons & Monsters  
Lore: Ghosts & Faeries  
Lore: Geomancy & Lines of Power  
Lore: Religion  
Photography  
Research  
Writing

**Note:** Instrument Reading — see Pilot Related Skills.

## WEAPON PROFICIENCIES (W.P.)

### *Ancient Weapons*

W.P. Blunt  
W.P. Chain  
W.P. Knife  
W.P. Sword  
W.P. Staff

Also see Fencing under Physical Skills.

### *Modern Weapons*

W.P. Revolver  
W.P. Automatic Pistol  
W.P. Semi & Fully Automatic Rifle  
W.P. Rifle  
W.P. Sub-Machinegun  
W.P. Heavy

*Energy Weapons (Military, Specialist or Trade School only)*

Energy Pistol  
W.P. Energy Rifle

**Note:** Weapon Systems; see Pilot Related Skills.





# SKILL DESCRIPTIONS

## COMMUNICATIONS

**Cryptography:** Skill in recognizing, designing, and cracking secret codes and messages. After ten minutes of studying a code, the character can attempt to decipher it, but at a -10% chance. Otherwise, the character must study for two hours before every additional roll. **Base Skill:** 30% + 5% per level of experience.

**Laser:** This skill provides the character with an in depth knowledge of laser communication systems. **Base Skill** is 40% + 5% per level of experience.

**Optic Systems:** Training covers a wide variety of optic systems, from video to optical enhancement devices, to laser optics. The character will understand the how to interpret optical readings, recording, transmission, and will know how to use special equipment like thermo-imagers, passive light intensifiers, infrared, ultraviolet, etc. **Base Skill:** 50% + 5% per level of experience.

**Radio Communications:** All these skills enable the character to effectively use various communications equipment and techniques.

**Radio: Basic Communications:** This is the knowledge of the operation and maintenance of field radios and walkie-talkies, wire laying, installation, radio procedure, communication security and visual signs/communications, as well as knowing Morse code. **Base Skill:** 50% + 5% per level of experience.

**Radio: Scramblers:** This is training in the use of electronic masking and scrambling (unscrambling) equipment, and codes, for increased security. **Base Skill:** 40% + 5% per level of experience.

**Radio: Satellite Relay:** This is an understanding in the methods and operations of satellite transmissions. **Base Skill:** 25% + 5% per level of experience.

**Surveillance Systems:** This is the study and understanding of the operation, methods, and techniques in the use of surveillance systems. Includes motion detectors, simple alarm systems, complex alarm systems, video and camera equipment, amplified sound systems, miniature listening devices (bugs, telephone tapping), recording methods, and some optical enhancement systems (specifically as they relate to camera lenses). **Requires:** Electronics (basic) or electrical engineering. Photography skills, prowl, and investigative skills may also be useful, but not required. **Base Skill:** 40% + 5% per level of experience.

*Tailing*, or following someone without their knowledge, is another form of surveillance. This also includes stake-out procedures. A failed surveillance roll indicates that the tail was spotted and the subject is aware of being observed/followed. A failed roll in the use of equipment indicates ruined or garbled recording/film (not usable) or malfunction. Bugging equipment can be easily located or noticed through the course of casual activity if a character fails his surveillance roll while planting it.

**T.V./Video:** Techniques and understanding of video and audio, filming, editing, special effects, transmissions and equipment. **Base Skill:** 40% + 5% per level of experience. Spending two skills on this one skill area makes the character of professional film quality/abilities. A one time bonus of 10% applies in this case.

## COMPUTER

**Computer Operation:** A knowledge of how computers work, along with the skills to operate peripherals like keyboards, printers and modems. Characters can follow computer directions, enter and retrieve information, and similar, basic, computer operations. However, this does NOT include programming. **Base Skill:** 60% + 5% per level of experience.

**Computer Programming:** Designing, programming, debugging, and testing computer programs/software. **Note:** Computer Operation is required before taking computer programming. **Base Skill:** 40% + 5% per level of experience.

**Note:** Computer Repair is found under mechanical skills.

## DOMESTIC

**Note:** All domestic skills taken as part of a *Scholastic Skill Program* are considered to be of professional, commercial calibre. If chosen as a *secondary skill*, the abilities are satisfactory, but still amateur.

**Cook:** Skill in selecting, planning and preparing meals. A cooking roll failure means that the cooked food is either inedible (burnt!) or distasteful. **Base Skill:** 50% + 6% per level of experience.

**Dance:** A practiced skill in the art of dancing. **Base Skill:** 40% + 6% per level of experience.

**Fishing:** These are the fundamental methods and enjoyment of the relaxing sport of fishing. Areas of knowledge include the use of lures, baits, poles, line, and the cleaning and preparation of fish for eating. **Base Skill:** 60% + 5% per level of experience.

**Sewing:** The practiced skill with the needle and thread to mend, layout, cut and sew simple patterns, and do minor alterations. This is a tailoring ability as a scholastic skill. **Base Skill:** 40% + 5% per level of experience.

**Sing:** The simple ability to read music and carry a pleasant tune. **Base Skill:** 40% + 5% per level of experience. The character's singing is of professional quality if taken as a scholastic skill.

## ELECTRICAL

**Basic Electronics:** This is a rudimentary understanding of the principles of electricity, simple circuits, wiring, and so on. This person can do basic wiring, repair appliances and read schematics. **Base Skill:** 40% + 5% per level of experience.

**Electrical Engineer:** Knowledge of electricity. Characters can



diagnose and locate electrical problems. It is also possible to put together electrical equipment. The character can attempt to bypass security systems and burglar alarms at a  $-25\%$ ; if Surveillance Systems is also taken, then there is a  $+10\%$  bonus instead. **Base Skill:**  $45\% + 5\%$  per level of experience.

## ESPIONAGE

**Concealment:** Is the practiced ability of hiding something on ones body or in hand usually by continually moving it around from hand to hand or place to place unnoticed. Objects *must* be no larger than 14 inches in height and length, 6 inches in width and weigh 10lbs or less. The smaller lighter the item, such as a knife, gem, small sack, scroll, etc., the easier it is to conceal. Larger items such as a book or club or statute or other similarly larger and heavier objects are more difficult to conceal on ones person for obvious reasons. Giant size characters can add six inches to the size and six pounds to the weight. Penalty of  $+5\%$  applies to items over 7 inches (remember 14 inches maximum) because it is a more difficult size. Larger than 14 inches are impossible to conceal. **Base Skill:**  $20\% + 5\%$  per level of experience.

**Impersonation:** This skill enables a person to impersonate another person or type of soldier (in general). This means the person must have a rudimentary (if not comprehensive) knowledge of the person or general type of personnel that he is impersonating. This is likely to include a knowledge of enemy/subject of impersonation military procedure, dress, command, rank, and will usually require speaking the language fluently. This means the character can convincingly impersonate a general type of person/soldier/advisor by accurate disguise, proper action, and language.

The **Base Skill** is  $40\%$  to impersonate general personnel and  $20\%$  to impersonate a specific individual (which may require weeks of study and special disguise),  $+4\%$  per level of experience.

The success of one's impersonation/disguise can only be determined after exposing oneself to those whom you wish to trick. A successful impersonation requires the player to roll under his skill for each of his first, THREE encounters. Afterward, the character must roll under his skill for *each* encounter with an officer. If interrogated/questioned, he must successfully roll for every other question or be revealed as an imposter. A **failed roll** means his impersonation has failed, he is recognized as an imposter and is in immediate danger.

**Interrogation:** This skill includes training in the questioning of prisoners, captives and informers, and the assessment of that information. **Base Skill:**  $40\% + 5\%$  per level of experience.

**Land Navigation:** This skill allows the person to stay on course, while traveling over land, by means of observation. This includes mentally marking/recognizing geographic landmarks, estimating distance and movement, recognizing sounds, and other navigation tricks. Techniques include night travel. The player should roll once for approximately every three miles traveled. A failed roll means the group is drifting off course by 200-2000 yards (roll  $2D10 \times 100$  yards). Do not roll again until the next three miles. A successful roll at that time will allow the character to recognize his error and correct it. Of course, errors mean lost time and traveling through unknown or potentially dangerous areas. A second

(and third), failed roll means the team continues to travel  $2D10 \times 100$  yards further off course. All failed rolls are cumulative unless corrected.

**Note:** A group of average men can cover approximately 5 miles an hour at a brisk, but relaxed pace, through grassland, along dirt roads or paved streets. Travel through dense forest or jungle at a cautious pace, with eyes open for danger, is about one mile per hour. At this pace, one can easily watch for booby traps, snipers, ambushes, wild animals, tracks, clues and other observations, without fear of traveling too fast (and missing them). Only at a faster pace will one begin to miss details and court death. **Base Skill:**  $40\% + 4\%$  per level of experience.

**Palming:** Simply the ability to pick up and seemingly make a small object such as a coin, key, playing card, knife, etc. disappear by hiding or concealing it in one's hand. Adds a bonus of  $+5\%$  to pick pocket skill. **Base Skill:**  $25\% + 5\%$  per level of experience.

**Detect Ambushes:** Training which develops an eye for spotting locations and terrain suitable for ambushes and being ambushed. It also provides a rudimentary knowledge of guerilla tactics used by the enemy. **Base Skill:**  $40\% + 5\%$  per level of experience.

**Detect Concealment:** This is a skill which enables the individual to spot and recognize camouflage, tricks, concealed huts, buildings and vehicles, as well as the ability to construct unobtrusive shelters that blend into the environment. **Base Skill:**  $30\% + 5\%$  per level of experience.

**Disguise:** The character knows how to apply make-up, wigs, skin putty, and other special effects, in order to alter his own appearance or those of somebody else. **Base Skill:**  $40\% + 5\%$  per level of experience.

**Escape Artist:** The character will know the methods, principles, and tricks of escape artists. By tensing and relaxing muscles, flexing and popping joints, the character can try slipping out of handcuffs, straightjackets, etc. Also includes a knowledge of knots and the ability to conceal small objects on the person. Picking Locks is a separate skill. **Base Skill:**  $30\% + 5\%$  per level of experience.

**Forgery:** The techniques of making false copies of official documents, signatures, passports, I.D., and other printed material. The character must have an original or photocopy to work from in order to make an accurate copy. Skilled forgers can recognize other counterfeits at  $-6\%$ . **Base Skill:**  $30\% + 5\%$  per level of experience.

**Intelligence:** This is the specific training in the practices and principles of recognizing and analyzing sources of information about the enemy, observation techniques, counterintelligence measures and proper procedure. This includes the practical assessment of sights and sounds, estimation of ranges, what to report, handling prisoners of war, and handling captured documents and equipment (tagging and reporting to group leader or proper authority).

This means the character will be able to accurately estimate ranges; the number of enemies/troops, direction, purpose; and assess the importance of specific information, documents and prisoners.

Further intelligence training includes a working knowledge of indigenous guerrilla warfare, practices, concealment



techniques, appearance, and current activities. This will enable the intelligence officer to recognize suspicious activity as guerrilla actions and identify guerrilla operatives. **For Example:** A particular booby trap, or weapon, or mode of operation, may be indicative of guerrilla activity in that area. It may be up to the character to confirm the existence of guerrillas, and their strengths and numbers, in a particular area.

Another area of training, made available to intelligence, is the identification of enemy troops, officers and foreign advisors. This means the person learns the many distinguishing ranks and marks that identify specific military units, special forces, and officers of the enemy. Such identification can pinpoint and confirm enemy operations, goals and movement, as well as confirm outside intervention/aid. **Note:** A failed roll in any of the intelligence skills means that evidence is inconclusive, or the character has incorrectly assessed the information/situation and is uncertain. A failed roll involving individual clues may mean the intel officer has dismissed it entirely as being meaningless. (GM's, use your discretion). **Base Skill:** 42% + 4% per level of experience.

**Picking Locks:** The character knows the methods, techniques and tools for picking/opening key, and basic, tumbler type locks.

It takes 1D6 melee rounds for each attempt to pick a lock. A failed roll means the lock holds; try again. **Base Skill:** 35% + 5% per level of experience.

**Pick Pockets:** An ability to remove items from a person without their being aware of it. If a pick pocket attempt fails, the item has NOT been removed and there is a 67% likelihood of the intended victim recognizing the intent of the action. **Base Skill:** 30% + 5% per level of experience.

**Sniper:** This skill represents special training in long-range rifle firing, and marksmanship. The character must first have a semiautomatic rifle or bolt-action rifle skill, to which the sniper skill bonus of +2 to strike can be applied.

**Tracking:** Visual tracking is the identification of tracks, and following the path of men or animals by the signs they leave on the ground and vegetation. Tracking is a precise art, requiring much practice. The skill includes the evaluation of tracks, indicating whether the person being tracked is loaded down with equipment, running, moving slowly (by measuring the space between steps), male, female, walking backwards, injured (staggered footprints), and so on. By this means, the tracker can estimate the person's rate of movement, apparent direction, the number of persons in the party, and whether the person knows he's being followed. Other methods of tracking require recognizing other telltale signs, such as blood and other stains, broken and displaced vegetation, overturned rocks; litter, such as cigarette butts, ration cans, candy wrappers, soiled bandages and remains of camp fires, and even odors carried by the wind.

Tracking also includes the recognizing of dangerous animals by their tracks, habits and feces. Likewise, tire tracks of vehicles can reveal much, such as size and type of vehicle, weight of load, etc.

**Counter-Tracking** techniques are also known, such as covering one's trail; avoiding obvious pitfalls, such as littering, misdirection, parallel trails, and others.

**A failed roll** means that the signs are inconclusive, vague

or misleading. Additional signs must be found to verify or clarify (roll again). Three, consecutive, failed rolls means the tracker has completely lost the trail. Roll once every 40 yards when FOLLOWING a trail. Persons attempting to follow a skilled tracker are -20% in following his trail, if he is deliberately trying to conceal that trail (however, his rate of travel is reduced by half). **Base Skill:** 30% + 5% per level of experience.

**Wilderness Survival:** Techniques for getting water, food, shelter, and help, when stranded in wild forests, deserts or mountains. Characters without this skill the character will not be able to stay healthy for more than a few days out in the wilderness area. **Base Skill:** 40% + 5% per level of experience.

## MECHANICAL

**Automotive Mechanics:** Ability to repair, rebuild, modify, and redesign conventional vehicles with internal combustion (gas) engines, as well as body work, turbine engines, and diesel truck engines. **Base Skill:** 50% + 3% per level of experience.

**Aircraft Mechanics:** The understanding, ability to repair, rebuild, modify and redesign conventional aircraft; including single and twin engine airplanes, fan jets, jets, fighter jets, helicopters and shuttle craft. **Base Skill:** 45% + 3% per level of experience.

**Basic Mechanics:** This is a rudimentary understanding of how machinery operates. This person can repair and maintain simple mechanisms and common automobiles. **Base Skill:** 40% + 4% per level of experience.

**Computer Repair:** Knowledge of the internal electronics of computers and related devices (terminals, printers, etc. . . .). The character can attempt to repair, sabotage, or fix computers. Note that figuring out a repair problem requires one roll, and the character must roll again before actually fixing it. No computer operation or programming skills are included. Many computer repair personnel don't even know how to turn the machines on! **Base Skill:** 40% + 5% per level of experience.

**Locksmith:** The practiced study of lock designs, and ability to repair, build, modify and "open" locks. The methods, techniques, and tools of lock picking include the old-style key and tumbler, combination, and modern electronic locking systems. **Time Requirements:** 1-4 melees to open an antiquated, key type lock; 1-6 minutes to open an elaborate tumbler type; 2-16 minutes to open a simple electronic lock (usually by patching in a bypass system); and 1-6 hours to break a complex, state-of-the-art electronic lock system, such as those used in high security and restricted areas.

If an unsuccessful skill roll is made, the lock is *not opened and the process must be repeated*. If an attempt to open an electronic lock fails, roll to see if the lock has been irreparably damaged; 32% chance. If damaged, the lock CANNOT be opened. **Base Skill:** 25% + 5% per level of experience. **Special Bonus:** Add a one time bonus of 5% if the Electronics Skill is also taken.

**Mechanical Engineer:** A training, understanding and knowledge of how machinery is designed, operated, built, and maintained. Characters can attempt to redesign, modify, sabotage, repair, or construct mechanical devices. The first percentage is how to operate/analyze/design machinery; the second is



how to repair, construct or sabotage. **Base Skill:** 45% + 5% per level of experience. **Special Bonus:** + 5% to Locksmith skill and 5% to Surveillance Systems skill.

## MILITARY

**Demolitions:** Demolitions provides the person with an advanced knowledge in the use and workings of explosives and detonation devices for the purpose of blowing up bridges, buildings, and sabotage. This includes *all* types of explosives, such as mines, dynamite, plastics, nitro, blasting caps, etc. It also includes a basic understanding of the strategic placement of mines and booby traps. This will increase a character's awareness of suspicious rope, string and wire. **Base Skill:** 60% + 3% per level of experience. A failed roll means a dud; no explosion.

### **Demolitions Disposal (or Explosive Ordnance Disposal):**

This skill enables the character to safely defuse unexploded mines, bombs, explosive booby traps, dud artillery rounds, dud explosive charges, or any other explosive device. **Base Skill:** 60% + 3% per level of experience. A failed roll means the item has exploded without warning.

**Pilot Tank:** The piloting of armored assault vehicles, includes armored all terrain vehicles, amphibious recon, and other, armored heavy vehicles and construction vehicles. **Base Skill:** 50% + 4% per level of experience.

## MEDICAL

**Criminal Sciences & Forensics:** Basic knowledge of police skills. Includes simple criminal law, fingerprinting, ballistics (matching bullets to weapons and angles of impact), and general investigative techniques. Forensic medicine is also included, allowing the character to find evidence of time of death, cause of death, and other details when examining a corpse. **Note:** Biology, Chemistry, Chemistry-Analytical, and some Mathematics, are all required before taking Criminal Sciences & Forensics. **Base Skill:** 35% + 5% per level of experience.

**First Aid:** Rudimentary medical treatment which includes how to bandage wounds, stop bleeding, administer CPR/artificial respiration, and use antiseptics, and common anti-inflammatory drugs and pain killers. **Base Skill:** 50% + 5% per level of experience. A failed roll means the patient has not responded to treatment or that treatment was improperly applied.

**Paramedic:** An advanced form of medical emergency treatment which includes *all* first aid techniques, the setting of broken bones, suturing of wounds, use of oxygen and emergency equipment, use of drugs, knowledge of how to move a critically injured person, and other lifesaving techniques. A **failed roll** means the patient has not responded to treatment or that the treatment has been improperly administered. **Note:** For serious injury or coma, roll three times, consecutively, on percentile dice. A roll of two successful out of three means the wound has been properly treated or the patient's condition is stabilized. Failure means the patient's condition is unchanged. Another character can immediately attempt to apply medical aid or the same player can try again, but only after he or she has spent six minutes of examination and/or concentration. **Base Skill:** 50% + 6% per level of experience.



**Medical Doctor:** The character needs a Ph.D. (doctorate degree), with Master's of Science, to be a practicing doctor.

Areas of training/study include: clinical skills, medical discipline, code of ethics, laboratory skills, techniques, methods of data collection, physiology (muscles, respiratory, blood, body fluids); fundamentals, principles and procedures of pathology (diseases, their structure and function), and rudimentary pharmacology (use, reaction, and interaction of drugs). The medical doctor (M.D.) is also trained in surgical procedures (he is a surgeon). **Note:** the first percentile number indicates the ability to diagnose a problem and the second is the ability to successfully treat it. **Base Skill:** 70/60% + 3% per level of experience.

**Pathology:** This is that branch of medicine that deals with the nature of diseases, their causes and symptoms, and the functional and structural changes caused by disease. Training includes anatomy, physiology, cell biology, manifestation of disease, tissue injury and repair, abnormal cell structure, metabolism, diagnosis of human disease, tissue culture methods and applications, analysis of drugs in biological samples and laboratory research, investigative methods, and use of instruments, tools and equipment. **Requirements:** Chemistry. **Base Skill:** 45% + 5% per level of experience.

## PHYSICAL

**Special Note:** One of the unique aspects of this RPG is that the player can build and increase his or her character's physical attributes (P.S., P.P., P.E., Spd, S.D.C.) by selecting physical skills. ALL attributes and skill bonuses are accumulative. Only one hand to hand skill can be selected and a skill may only be chosen once. Educational bonus applies to all individual skill abilities when applicable.

**Hand to Hand Combat:** There are three major kinds of fighting techniques available to all characters:

**Hand to Hand Basic:** This provides the fighting techniques taught in military basic training or in self-defense classes. Students learn elementary methods of attack and self-defense. Counts as one skill. *See the combat section for listing of specific abilities.*

**Hand to Hand Expert:** An advanced form of self-defense and



unarmed combat usually taught to commandos. Counts as two skills. *See the combat section for listing of specific abilities.*

**Hand to Hand Martial Arts:** This is some form of oriental fighting skill (karate, kung-fu, etc.) that teaches advanced hand to hand combat. Counts as two skills (except for the Military Specialist and special conditions for upgrading Hand to Hand Combat). *See the combat section for listing of specific abilities.*

**Acrobatics:** Aerial feats of agility and strength, such as walking a tightrope, high wire, trapeze, and stunts performed above the ground. Other physical abilities include rolls, somersaults, leaps and falls. Provides the following abilities:

60% + 5% per level — Sense of Balance.

60% + 5% per level — Walk Tightrope or High Wire.

80% + 2% per level — Climb Rope.

40% + 4% per level — Climbing (or adds a bonus of + 15% to Climb skill).

60% + 5% per level — Back Flip.

30% + 5% per level — Prowl (or adds a bonus of + 10% to Prowl skill).

+ 2 to Roll with Punch/Fall.

+ 1 to P.S.

+ 1D4 to P.P.

+ 1 to P.E.

+ 1D6 to S.D.C.

Leap four feet high and five feet long, plus 2 feet per level of experience.

Fearless of heights.

**Archery:** The practiced use of a bow and arrow and cross bow. The archery skill is effectively a weapon proficiency with bow weapons.

*Bonus to strike* with bow and arrow/cross bow: + 1 at first level plus + 1 to strike for each additional TWO levels of experience. *For example:* Level one + 1, level three + 2, level five + 3, and so on.

*Rate of Fire:* Two at level one and ONE for each, additional TWO levels of experience. *For example:* Level one 2 shots per melee, level three 3 shots, level five 4 shots and so on.

Bow Type and Ranges	Damage Per Arrow
Short Bow (ninja) — 420ft	1D6
Large Bow (long bow) — 700ft	1D8
Compound Bow — 800ft	2D6
Cross Bow — 700ft	1D8

**Athletics (general):** Training in, and enjoyment of, vigorous exertion for competitive sports, exercises, and contests of strength, endurance and agility. Provides the following:

+ 1 to parry and dodge.

+ 1 to strike with a body block/tackle; does 1D4 damage.

+ 1 to roll with punch or fall.

+ 1 to P.S.

+ 1D4 to Spd.

+ 1D8 to S.D.C.

**Body Building:** The building of muscle tone and body strength through weight lifting and exercise. Provides the following:

+ 2 to P.S.

+ 10 on S.D.C.

**Boxing:** Classic art of fighting with fists. Training helps build the body and reflexes. Skilled boxers will *Automatically*

Knockout opponents on a natural twenty for 1D6 melees rounds. Unlike normal Knockout/Stun, this does NOT have to be declared before the strike roll.

One additional attack per melee.

+ 2 to Parry/Dodge

+ 2 to Roll with Punch/Fall

+ 1D4 to P.S.

+ 2D6 on S.D.C.

**Climbing:** Knowledge of the tools and techniques for climbing up sheer surfaces. Players should roll once for every 20ft (6m) of a vertical climb. Every "skilled" climber gets a second roll to recover his/her hold. **Base Skill:** 50% + 8% per level of experience.

*Rappelling* is a specialized, rope climbing skill used in descending from helicopters, scaling walls and cliff facings. For game purposes, rappelling will include ascending and descending climbs. Minimum base effectiveness is 30% + 5% per level of experience. A failed roll means a slip or fumble; roll again to regain hold or fall. Provides the following:

+ 1 to P.S.

+ 1 to P.E.

+ 1D6 to S.D.C.

*Damage from Falls:* 1D6 from a 10 foot height plus 1D6 for each additional 10 feet of height, or fraction thereof.

**Fencing:** The ancient arts of Hand to Hand Weapons are learned from fencing teachers. This includes not only olympic-style fencing with foil, epee or saber, but also Kendo (use of the Samurai sword) and other weapons. Adds a bonus of + 1 to strike and parry when combined with W.P. Sword. **Note:** Paired Weapons is a separate skill. See the W.P. Tables in the Combat Section for details.

**Gymnastics:** Learning to do falls, rolls, tumbles, cartwheels, and to work on rings and parallel bars. Characters with Gymnastics can leap 4ft up or 4ft across, with an additional, 2ft per level. **Note:** Characters with Leap Attack can use these distances in a strike. Provides the following abilities:

50% + 5% per level Sense of Balance.

70% + 2% per level Climb Rope.

20% + 6% per level Climbing (or adds a bonus of + 10% to a climb skill).

70% + 8% per level Back Flip.

30% + 5% per level Prowl.

+ 2 to Roll with Punch/Fall.

+ 2 to P.S.

+ 1 to P.P.

+ 1 to P.E.

+ 2D6 to S.D.C.

Leap four feet high and four feet long plus 2 feet per level of experience.

**Prowl:** This skill helps the character to move with stealth; quietly, slowly and carefully. Techniques include balance and footing, short steps and pacing, rifle positioning, prone positions for low visibility, and crawling. A failed Prowl roll means that the character has been seen or heard. If the Prowl is successful, then the character is not seen and may make a Sneak Attack. **Base Skill:** 46% + 8% per level of experience.

**Running:** A routine of running and exercise to build speed and endurance.

+ 1 to P.E.



- +4D4 to Speed
- +1D6 to S.D.C.

**Swimming:** The rudimentary skill of keeping afloat, dives, lifesaving, and swimming techniques. **Base Skill:** 50% + 8% per level of experience. The percentile number indicates the overall quality of form as skill of execution. A special bonus of +1 to parry and dodge while in water applies. **Note:** A character can swim a distance equal to  $3 \times$  his P.S./Strength in yards/meters per melee. This pace can be maintained for a total of melees equal to his P.E./Endurance.

**Swimming Advanced:** Competitive swimming and advanced techniques including dives, lifesaving, snorkel and S.C.U.B.A.

**S.C.U.B.A:** The letters S.C.U.B.A. stand for Self-Contained Underwater Breathing Apparatus. Characters learn the methods of skin diving and underwater swimming, and use of oxygen tanks/apparatus, mask and flippers. **Base Skill:** 50% + 5% per level of experience and reflects the degree of skill and expertise at S.C.U.B.A. **Note:** A character can swim a distance equal to  $4 \times$  his P.S./Strength in yards/meters per melee. This pace can be maintained for a length of time equal to  $4 \times$  his P.E./Physical Endurance in melees. *Advanced swimming provides the following:*

- +2 to dodge *underwater*.
- +3D4 to Spd. when swimming only.
- +1D6 to S.D.C.

**Wrestling:** As taught in High Schools and Colleges, wrestling is more of a sport than a combat skill, but it does provide useful combat training.

Pin/Incapacitate on a roll of 18, 19, or 20.

Crush/Squeeze does 1D4 damage.

Body Block/Tackle does 1D4 damage and opponent must Dodge or Parry to avoid being knocked down.

- +2 to Roll with Punch/Fall.
- +2 to P.S.
- +1 to P.E.
- +3D6 on S.D.C.

## PILOT SKILLS (Ground, Air, Water)

**Automobile:** Skill in driving conventional automatic and manual (stick) transmission cars, jeeps, and mini-vans. **Base Skill:** 76% + 4% per level of experience.

**Race Car:** Training in piloting automobiles specifically designed for high speed competition (like the Indy 500 Formula cars) at speeds of 200mph and greater. **Base Skill:** 55% + 5% per level of experience.

**Motorcycle:** The practiced skill of riding a motorcycle. **Base Skill:** 60% + 4% per level of experience.

**Truck:** Manual or automatic transmission; includes vans and trailers. **Base Skill:** 60% + 4% per level of experience.

**Airplane:** Includes the old propeller, single and twin engine types. **Base Skill:** 70% + 4% per level of experience.

**Boats: Sail Type:** **Base Skill:** 60% + 4% per level of experience.

**Boats: Motor Type:** Large and small (not ships). **Base Skill:** 60% + 4% per level of experience.

## PILOT ADVANCED AIRCRAFT

**Basic Helicopter:** Includes the small, two-seater, observation

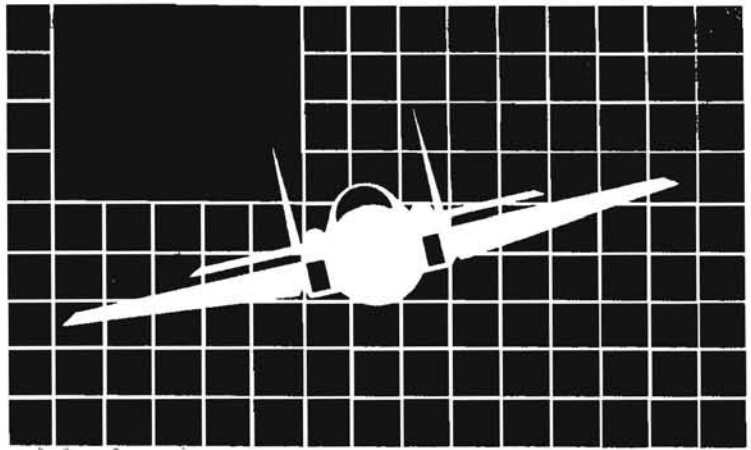

types; large transport and assault. **Base Skill:** 60% + 4% per level of experience.

**Combat Helicopter:** Requires special training in assault type helicopters of all kinds, as well as the use of their weapons.

**Base Skill:** 52% + 4% per level of experience.

**Jet:** Includes the fan jet and commercial jet liners. **Base Skill:** 60% + 4% per level of experience.

**Fighter Jet:** Training in the flying, maneuvering, techniques and weapons of jet fighter planes. **Base Skill:** 50% + 4% per level of experience.

**Space Shuttle:** **Base Skill:** 50% + 4% per level of experience.

**Note:** See *combat section* for ground and air maneuvers and combat.

## PILOT RELATED SKILLS

**Navigation:** Skills in map reading, star charts, course computation, following landmarks, and use of navigational equipment. Includes air, land and water navigation, as well as piloting by instruments alone. **Note:** Basic mathematics and read sensory equipment are required to navigate. **Base Skill:** 60% + 5% per level of experience. A failed roll means the pilot is off course. Roll  $2D6 \times 100$  for aircraft,  $4D6 \times 100$  for Fighters, and  $1D6 \times 100$  for land vehicles, to determine how many miles/kilometers they are off course. Roll for every hour that one is off course.

**Navigation – Space:** Basically the same as normal navigation techniques. The only difference is the use of stars, and some of the sensory equipment. **Base Skill:** 60% + 5% per level of experience.

**Read Sensory Equipment:** Individuals with this training can maintain, understand, operate, and “read,” or interpret, sensory data from all types of conventional sensor devices. These devices include radar, sonar, motion detectors, surveillance equipment, optical enhancement, instrument panels and so on. **Base Skill:** 40% + 5% per level of experience. **Note:** Characters without a sensory skill can not understand nor operate air vehicles, radar or detection/surveillance equipment.

**Weapon Systems:** This is the complete understanding of weapon units and systems incorporated in *vehicles*. It includes the, vast variety of weapons, energy weapons, missile launchers, and so on. **Special Bonus:** +2 to strike. **Note:** Characters without weapon systems skill will be able to operate them only if skilled in piloting that vehicle (like Pilot Helicopter, etc.), but have no bonus to strike and never have



the initiative. **Base Skill:** 50% + 2% per level of experience, and represents the overall comprehension and ability of the character.

## SCIENCE

**Anthropology:** This is the behavioral study of man and his environments. Studies include societies, customs and beliefs, political structure, as well as rudimentary history and archaeological background. The skill can be used to identify the probable time period, people/race and therefore, beliefs and culture, probable place of origin, and probable purpose of artifacts and ruins. Of course, these are all educated guesses based on behavioral, historical and comparative studies. The anthropological knowledge of customs and beliefs is also useful in dealing with other cultures and to avoid accidentally breaking taboos or codes of behavior. **Base Skill:** 35% + 5% per level of experience.

**Archaeology:** This is the scientific study of relics of ancient civilizations by excavation and analysis of artifacts. Studies include proper excavation (digs) techniques, preservation, restoration and dating (including carbon dating) methods, as well as rudimentary history and anthropology background. The skill can be used to excavate/recover and clean/restore ancient artifacts and ruins, more accurately determine age/date of the artifact, establish authenticity and identify the likely time period, place of origin, and people race. **Base Skill:** 40% + 5% per level of experience.

**Note:** Excavations are extremely time consuming and laborious, requiring weeks, months or even years of work and study. Likewise restoration and accurate dating processes require the proper chemicals, equipment, facilities and time. Determining an accurate date of an artifact will place the object under several tests to establish its age. The length of time and level of accuracy under scientific conditions is listed on the following chart. Scientific determination of an item's age can be conducted by the character (if proper facilities are available) or an item can be sent to a laboratory that specializes in it. The latter is expensive, costing as little as one thousand dollars for items only a few hundred years old and as much as \$10,000 to \$40,000 for an object which is thousands or millions of years old. The artifact can be a man-made item or roots, rocks or dirt samples.

Age In Years	Level of Accuracy
300 years old or less	Within 2D4 years
301-500 years old	Within 2D6 years
501-1000 years old	Within 3D6 years
1001-2000 years old	Within 6D6 years
2001-5000 years old	Within 1D6 × 10 years
5001-10,000 years old	Within 2D6 × 10 years
10,001-50,000 years old	Within 3D6 × 10 years
50,001-200,000 years old	Within 2D6 × 100 years
200,001-1,000,000 years old	Within 3D6 × 100 years
Over 1,000,000 years old	Within 2D6 × 1000 years

**Astronomy:** The study of the stars and other celestial bodies, their movements, positions, cycles, alignments, and interrelations with the earth and each other. This knowledge can also be used to determine direction, season and time of day. **Base Skill:** 50% + 5% per level of experience.

**Astrophysics:** Knowledge of stellar astronomy and how it re-

lates to nuclear physics, quantum mechanics, relativity, and other explanations for the creation of deep space phenomena, like quasars and black holes. **Note:** Basic and advanced Mathematics is required before taking Astrophysics. **Base Skill:** 30% + 5% per level of experience.

**Biology:** Basic understanding of cells, anatomy, physiology, evolution and genetics. The character will know the basic use of a microscope, cultivating bacteria and how to classify new organisms. **Base Skill:** 40% + 5% per level of experience.

**Botany:** Plants, their categories and functions, are studied extensively. Characters will know the basics of cross-fertilization, and germinating and growing experimental plants. **Base Skill:** 40% + 5% per level of experience.

**Chemistry:** Basic understanding of chemical principles and formulae. Characters know enough chemical laboratory procedures, for analyzing and synthesizing chemical compounds, in order to be competent assistants. **Base Skill:** 50% + 5% per level of experience.

**Chemistry – Analytical:** Chemical engineering theories useful in the analysis of compounds and their practical applications. Characters will be highly skilled in the use of laboratory equipment, and can analyze and synthesize chemicals. **Note:** Basic and Advanced Mathematics are prerequisites. **Base Skill:** 45% + 5% per level of experience.

**Chemistry – Pharmaceutical:** This is the study of drugs and their interaction with the human body. Knowledge includes a familiarity with common medical drugs, drug interactions, dosages, the use/distribution of drugs, their effects on the human body, and other biological applications. The skill will enable characters to recognize common drugs and their effects, recognize poisons/toxins, and safely administer existing drugs (painkillers, hallucinogens, stimulants, relaxants, antibiotics, sodium pentothal/truth serum, tranquilizers, and so on). **Base Skill:** 40% + 5% per level of experience. A failed roll means the drug is improperly administered or prepared, and has no effect.

**Mathematics – Basic:** Includes basic addition, subtraction, multiplication, division and fractions. **Base Skill:** 80% + 2% per level of experience.

**Mathematics – Advanced:** Includes algebra, geometry, trigonometry, calculus and techniques for advanced mathematics. **Base Skill:** 64% + 4% per level of experience.

**Psychology:** The study of the human mind and human behavior. It scientifically tries to unravel the psychological process by considering the effects of such intangibles as attitude, desires, thoughts, memories, stress, environment, dreams and emotion. The psychology skill provides the character with a complete, broad understanding of the principles, practices and theories of psychology. Thus, he or she will recognize abnormal behavior (phobias, psychoses, obsessions, neuroses, etc.), stress and exhaustion, as well as suggest a therapy. The character will also be able to recognize the use/presence of unnatural influences, such as drugs, hypnosis and other mind control (like magic enchantment and possession). **Base Skill:** 40% + 5% per level of experience. A failed roll means that an abnormality has not been recognized or that an incorrect judgment has been made.

**Psychotherapy:** This training is an in depth knowledge of the principles, theories and evaluation of human behavior, and



includes analysis, understanding and treatment of emotional, mental, motivational, and perceptual disorders; interaction of emotion, nervous system, sensory-motor mechanisms, personality assessment, drug dependence, and treatment. This character will not only be able to recognize abnormal behavior (insanity) but is also able to treat the person himself (see cures for insanity). The individual is also able to assess another character's disposition, social/economic background, environment, probable alignment, and recognize the use/presence of mind/personality altering influences. **Base Skill:** 40/30% + 5% per level of experience. The first percentile number indicates the proficiency for recognizing and treating a psychological abnormality. The second number is the character's skill in accurately assessing characteristics, disposition, alignments, etc. The character must spend at least a half hour of conversation with the other person to make an assessment. Roll for each individual characteristic. Alignment assessments are limited to a general, good, selfish, evil, and *not* a specific alignment. **Note:** The psychotherapy skill can be selected *only* if the psychology skill is also selected. It is a prerequisite in this area of science.

## STAGE MAGIC

**Stage Magic** is entertainment and sleight of hand-type skills used by traditional magicians and escape artists, like Houdini and Blackstone. No real magic or psychic powers are usually a part of these "tricks" and gimmick illusions.

The skills that follow are identical to the *espionage skills* of the same title; only the Base Skill Proficiency is different.

**Concealment:** **Base Skill:** 25% + 5% per level of experience.

**Detect Concealment:** **Base Skill:** 35% + 5% per level of experience.

**Disguise:** **Base Skill:** 35% + 5% per level of experience.

**Escape Artist:** **Base Skill:** 35% + 5% per level of experience.

**Palming:** **Base Skill:** 30% + 5% per level of experience.

**Pick Locks:** **Base Skill:** 37% + 5% per level of experience.

**Pick Pockets:** **Base Skill:** 40% + 5% per level of experience.

**Sleight of Hand:** This is one of the *new* skills in the stage magic category. *Its selection counts as TWO skills.* A skill that involves the manual dexterity of hand and finger manipulation to perform certain feats. One of the tricks, or gimmicks, of sleight of hand is to distract the observer(s) with one hand and palm or otherwise manipulate an item with the other hand. Sleight of hand also includes a basic level of escape artistry. Techniques include hand positioning, tensing and relaxing muscles, keeping hand and wrist joints flexible, popping joints in and out, the study of knots, and usually a hidden lock picking tool(s).

**Skill Bonuses:** +5% to palming, +5% to pick pockets, +10% to escape artist, +6% to concealment. All are one time skill bonuses applicable immediately.

To escape from locked chains and manacles, the character must have the pick lock skill as well. Note that an escape artist does NOT need to see the knots, locks or manacles that hold him. Escapes and lock picking can be done by touch and/or sound, as well as sight.

## Time Restrictions and Penalties

Although the sleight of hand skill provides added skill and nimbleness of hands, the character is still restricted by time and

the odds against him. The following penalties apply whenever the character tries to pick a lock or escape his bonds. They generally reflect the complexity and difficulty of the job. In some cases, more than one penalty may apply. For Example: The character may be handcuffed, arms and legs/feet tied, and then locked in a chest (total darkness), for a *cumulative penalty of -25%*. ALL penalties are cumulative. **Note:** ALL the locks and vaults may be of the highest quality and supposedly unpickable; however, they are not super sophisticated. Bank vaults, professional security systems, electric locks, and electric alarm systems, are beyond the capabilities of the magician/escape artist. *See the Hardware: Electrical* character for the man to beat the sophisticated electronic systems

## Time Restrictions and Penalties.

*A failed skill roll means that time has been spent in a futile attempt. Try again! The same attempt by any character other than the stage magician will take three times as long.*

## Escape and Lock Pick Penalties

- 0% Rope and typical knots: One melee (15 seconds).
- 5% Rope and superior knots: 1D4 melees (15 to 60 seconds).
- 0% Key padlock: 1D4 melees.
- 5% Combination padlock: 1D6 melees.
- 15% Security combination lock: 2D6 melees.
- 5% Typical door key lock: 1D4 melees.
- 10% Security door key lock: 2D4 melees.
- 5% Any standard key lock (doors, chests, etc.): 1D6 melees.
- 5% Handcuffs: 1D4 melees.
- 20% Straightjacket: 2D4 melees.
- 15% Jail cell door: 2D6 melees.
- 5% Car trunk: 1D4 melees.
- 25% Vault door with a superior combination lock: 2D6 minutes from the outside, 2D6 melee rounds (30 seconds to 3 minutes) from inside the vault.
- 80% Electric lock/bank vault: 6D6 minutes.
- 20% Lack of proper tools; must use inferior, improvised tool(s), like a hairpin or belt buckle.
- 50% No tools at all
- 10% Total darkness.

**Contortionist:** The ability to temporarily dislocate bones from joints, fold and bend the body to fit into extremely small areas or through spaces normally too tiny for a normal person. Can fold into a two foot ball and flatten self to four inches. Adds +5% to escape artist skill. Adds +2 to roll with punch, fall or impact.

**Juggling:** The ability to toss "up" a number of objects, such as balls, clubs, knives, lit torches and almost any, usually small, objects and keep them continuously in the air. As a skilled expert, the practitioner develops a superior sense of coordination, manual dexterity and reflexes, which provides the following *abilities and bonuses*.

1. Four attacks per melee with a thrown weapon. This can include darts, knives, throwing axe, javelin, small spear, club and other small items appropriate for throwing. It does not include swords, maces, ball and chain, pole arms, staves, chairs or other objects. *Add one additional throwing attack at third level and another at sixth and ninth. The throw attack takes the place of normal hand to hand combat that melee.* This means the character can either attack by throwing missile weapons OR by engaging in hand to hand combat; he CAN



NOT do both in the same melee round.

2. **Bonuses:** +1 to strike with any thrown/missile weapon. +1 to parry. These are both in addition to hand to hand or W.P. skill.

3. **Number of Items Juggled:** Up to four objects/items at level one plus ONE for each additional level of experience.  
**Base Skill:** 50% + 5% per level of experience.

## TECHNICAL

**Art:** The ability to draw or paint or sculpt or do craft-work. Scholastic art skill indicates a professional quality, while a secondary skill indicates a talented amateur. **Base Skill:** 40% + 4% per level of experience.

**History:** An extensive and continuing study and love for world history. This skill provides the character with a general knowledge of the growth of civilizations, cultures, religions and myths, past and present. The character will recognize *major types* of ancient architecture/ruins, areas of historical significance, weapons, characteristics, demons and deities. Select one Lore as an area of particular interest, but note that the character's educational skill bonus will not apply to that lore area. **Base Skill:** (History) 45% + 5% per level of experience. A failed roll means a failure to recall specific details.

**Journalism:** Fundamental journalistic writing techniques, editing and news reporting, for newspapers, magazines, radio and television. It also includes typing skills. The writing quality is professional if selected as a scholastic skill, while a secondary journalism skill means a talented amateur. **Base Skill:** 40% + 4% per level of experience. A failed roll means it's horribly written.

## LORE (A General Description)

Lore is a study and knowledge of historical and contemporary beliefs, myths, legends, folk-tales, stories and unorthodox theories, regarding the supernatural or the unexplained. All lore skills will focus, in depth, on a particular area of interest and includes an historical and scientific viewpoint, as well as the less orthodox opinions. **The skill percentage** is used to indicate the degree of current knowledge and to recognize a subject's/item's relationship (or not) to any existing beliefs/myths or occurrences.

**Lore — Demons and Monsters:** This is a study of demonic entities and monster lore throughout the ages and around the world. It includes ancient and primitive culture's belief in demons, possession, reputed demon places of habitation, appearances, habits, weaknesses, strengths and similar data. This knowledge also includes unusual creatures or monsters, past and present, including the Loch Ness Monster, giants, bigfoot/yeti, sea serpents, and other unusual creatures, their habitat, characteristics and so on. As a skill, it can help the character to recognize what may be a particular type of demon or monster by description, drawings, photos, footprints, name, ritual or actions. **Base Skill:** 35% + 5% per level of experience.

**Lore — Ghosts and Faeries:** A study of reports, myths and legends regarding the supernatural, ghosts, apparitions, haunted houses and places, death cults, necromancy (rituals and purpose), mediums/seances, and near death experiences, as well as myths regarding faerie folk, including faeries, sprites, leprechauns, nymphs, woodland or nature spirits, goblins, gnomes, trolls, ogres, bogies and others; their magic,

powers, habitat, and so on. This includes ghosts, spirits and faeries of all cultures around the world. **Base Skill:** 35% + 5% per level of experience.

**Lore — Geomancy or Lines of Power:** A study of ley lines, burial mounds, places of power, megaliths, and geomancy beliefs, past and present. Geomancy and ley lines are the belief that certain places on earth are polarized with an unknown energy or forces that can heal, cause paranormal phenomena, attract supernatural forces, open dimensional gateways, are magical or are places of evil. The study includes "known" locations of such places, such as Stonehenge and the Bermuda Triangle, as well as the many theories behind them and the legacy of legends, mysteries, disappearances and dangers linked to each. The skill will provide the character with *insight* about the areas and enable him/her to recognize specific, *known*, places of power, as well as recognize unknown megalithic markers of these revered or feared places. **Base Skill:** 30% + 5% per level of experience.

**Lore — Religion:** A comprehensive study of the world's religions, past and present, their beliefs, rituals, holy places, pantheons of deities and supernatural creatures (demons, spirits, angels), stories of creation, myths and legends. The skill will help the character recognize specific rituals, their purpose, the deity(s), icons, and similar information. **Base Skill:** 30% + 5% per level of experience.

**Language:** Characters with a language skill can understand, speak, write and read in a language other than his/her native tongue. Language is one of the few skills which can be selected repeatedly as a *skill program* and/or repeatedly as a *secondary skill*, so long as a different language(s) is selected each time. Three languages can be selected for each skill program, but only one for each secondary skill. **Base Skill:** 55% + 5% per level of experience.

**Photography:** Taking black and white or color, still pictures. Characters will know how to load, develop and enlarge film. **Base Skill:** 50% + 5% per level of experience.

**Research:** Training in the use of methods, techniques, and locations, for finding information, including public records, libraries, federal information services, data bureaus, interviews, surveys, demographics, trade journals, clipping services, computer services, and legal searches. This skill is helpful in locating information about people, places and things. *The game master* will ultimately regulate the availability of accessible, *known* information regarding a particular subject. In some cases, there may be a ton of history and information, while, in others, very little or nothing at all (which may reveal something by its sheer lack of info). The research skill simply gives characters access to available data. **Base Skill:** 50% + 5% per level of experience. **G.M.**

**NOTE:** A good rule of thumb is to let players investigate/research something as much as they want, but keep the game moving along. If no information is available, find out where they are conducting research and say something like "Despite the help of the clerk, and three hours of research, you still find nothing (or nothing unusual)." If the character(s) wishes to keep looking, let him, but quickly click off the hours; "Another hour and still nothing." If another player conducting research elsewhere says "What do I find out at the City County Building? Make the answer a quick "Nothing" or "Something quite surprising." and tell him (perhaps in private). Do *not*



drag out the research aspect, but do consider a reasonable length of imaginary game time. Likewise, if the information is common knowledge or easy to locate, fast forward *through* what might be a couple hours research and tell the character what he has found. **ANY CHARACTER CAN ASK QUESTIONS AND DO RESEARCH!** However, the research skill will reduce the amount of time by half and the character is trained to notice relevant data that an untrained character is liable to overlook. Thus, for the truly mysterious, secret or difficult information, have the character with the research skill try to uncover it. Only *roll* to determine success on these difficult or hushed up bits of information, including addresses, unlisted telephone numbers, car license plate numbers, obscure and suppressed data.

**Writing:** The ability to write prose (stories), poems or journalistically (articles/news). Scholastic writing skill indicates a professional quality, while secondary is a talented amateur. A failed roll means it is horribly written; try again. **Base Skill:** 34% + 4% per level of experience.

## WEAPON PROFICIENCIES

There are two categories of weapon proficiencies (W.P.): Ancient and Modern.

**Ancient Weapon Proficiencies:** Each skill area provides combat training with a particular type of weapon. The result is hand to hand combat bonuses to strike and parry, but only when that weapon is used. Each W.P. counts as one skill. The character may select several W.P. **Note:** Characters without a W.P. CAN use any weapon, but without bonuses.

**W.P. Blunt:** A skill with any type of blunt weapon, including mace, hammer, cudgel, pipe, staff and club. **Bonuses:** +1 to strike and parry at **level one**; add another +1 to strike and parry at **level four** and +1 to parry at **level eight**.

**W.P. Chain:** Includes ordinary lengths of chain, mace and chain, flail, nunchaku, etc. **Bonuses:** +1 to strike at **level one**; add another +1 to strike and parry at **level four** and +1 to parry at **level eight**.

**W.P. Knife:** Combat skill with all types of knives. **Bonuses:** +1 to strike when thrown, **level one**; +1 to strike and parry at **level two**, +1 to parry at **level five**, +1 to strike at **level six** and again at **level nine**.

**W.P. Sword:** Combat skill with large and small swords. **Bonuses:** +1 to strike and parry at **level one**; an additional +1 to strike and parry at **level four**, and again at **level eight**.

**W.P. Targeting:** This is a practiced skill in the use of *thrown* weapons and bow weapons. This weapon proficiency adds bonuses to the following weapon categories: Knives (thrown), throwing axe, spears/forks (thrown), sling, short bow, longbow, and crossbow. W.P. Targeting adds a bonus of +1 to *strike* at levels 2, 4, 7, 10 and 13. This bonus applies only to the weapon categories previously listed and then **ONLY** when that weapon is thrown (of course, arrows and bolts are fired from a bow and not actually thrown). It also increases the effectiveness range by 20ft for every level of experience; 10ft for knives, darts, and throwing axes.

**Modern Weapon Proficiencies:** These are areas of training and practiced skills with a particular type of modern weapon. Each W.P. counts as one skill. Characters may have several W.P. Each provides a bonus to strike. See the Combat Section for details.

## MODERN WEAPON PROFICIENCIES

The system for modern weapons presented here is identical to the rules and those found in the pages of the **The Revised Heroes Unlimited, Ninjas & Superspies and Robotech™**. While I feel these rules play much more quickly and cleanly, the original rules (still found in TMNT) are probably a little more realistic. Game masters and players can use *either* modern weapon combat systems without fear of disrupting the playability of either game.

The following rules *can* be applied to all of *Palladium Books®* role-playing games.

**Weapon Proficiencies (W.P.)** are areas of training and practiced skill with a particular type of weapon, such as revolver or sub-machinegun. This skill provides special bonuses to strike when using that weapon. Do not add this strike bonus to your character's hand to hand or combat skill bonuses to strike.

Weapon Proficiencies provide the following bonuses:

**Aimed:** +3 to strike.

**Burst:** +1 to strike.

**Wild:** No bonus or penalty.

**Training** also enables the character to easily reload, disassemble, unjam, clean and otherwise maintain the weapon. **Recognizes weapon quality** — 30% at level one and +6% per each additional level of experience. **Add a bonus** of +1 to strike for every **THREE** levels of experience beyond level one. When firing a weapon, there are three main modes or categories of attack: *aimed, burst or wild*.

### AIMED

An **aimed shot** means a person takes the time to carefully aim and squeeze off one, well placed shot. Each individual shot takes one full attack. Thus, if a character has four attacks per melee he/she can shoot **FOUR** aimed shots. This applies to all weapons. Roll to strike for each shot.

Bonus to Strike is +4 with a revolver or +3 for all others.

### BURST

A **burst** is the shooting of several rounds, immediately one after another. Aim is more hasty and the recoil moves the weapon with each shot, reducing the accuracy. *Semiautomatic/automatic weapons, machineguns and sub-machineguns*, are designed for burst firing. The concept is that, while accuracy is reduced, the odds of hitting one's target with multiple rounds is increased because more shots are fired.

Bonus to Strike is +1 with all weapons.

**Note:** Roll to strike once to see if the entire burst hits. Do not roll for each individual bullet. If the burst misses its target, then all the rounds in that burst miss.

### BURSTS OR SPRAYS FROM AUTOMATIC WEAPONS AND SUB-MACHINE GUNS

**Short bursts** fire 20% of the entire magazine; i.e., 30 round magazine — 6 rounds/bullets are fired. **Damage:** Roll the normal damage dice for **ONE** round × 2. Uses up one attack. Can be fired at only one target.

**Long burst** fires 50% of the entire magazine; i.e., 30 round magazine — 15 rounds/bullets are fired. **Damage:** Roll the normal damage dice for **ONE** round × 5. Uses up one attack.



Can be fired at only one target.

**Entire magazine:** Shooting off the entire clip/magazine within a melee round is possible. 100% of the rounds are fired.

**Damage:** Roll the normal damage dice for ONE round  $\times 10$ . Uses up *two* attacks that melee. Can be fired at only one target. Machineguns are the only exception to this rule.

**Spray:** Shooting a burst at several targets at once is possible, but the same as shooting wild. You must fire a *long burst* or an *entire magazine* in order to spray. See shooting wild.



## SHOOTING WILD

Shooting wild occurs when a trained character shoots without taking time to aim. This usually applies when the person is blinded, angry, running, rolling, leaping, shooting from a moving vehicle, etc.

**Bonus to Strike:** With W.P. there is no bonus or penalty; with no W.P. the person strikes at  $-6$ . Long bursts or the entire magazine must be fired. Counts as two attacks. Can be fired at one target or in a spray. **Damage for shooting wild at one target:** Roll normal damage dice for ONE round  $\times 2$ . Roll once to strike with the wild burst. **Hitting an innocent bystander** is a real possibility when shooting wild; 20% chance. Roll for each wild burst fired. **Damage** is the normal damage from one round (a wild shot).

**Spraying an area** with bullets can be dangerous and is considered to be shooting wild. The object of a spray is to hit several targets simultaneously. **First**, roll once to determine if you strike the target area; 1D20; 5 or higher strikes as usual. Then roll 1D4 to determine how many individual targets are struck within the target area. However, each target gets a roll to dodge to avoid getting shot. **Damage** is the normal damage from one round. **Hitting an innocent bystander** is even more likely; 50% chance. **Damage** is from one round (wild shot).

**Bursts or Sprays from a machinegun** is different only in the number of rounds fired, targets struck, and chance of hitting a bystander. Machineguns have a much greater ammunition capacity, so it does not have to use the same percentage of its entire clip.

**Short burst/one target:** 10% of rounds/magazine; inflicts normal round damage  $\times 2$ . Counts as one attack.

**Short burst spray:** 10% of rounds/magazine; inflicts normal damage from ONE round, hits 1D4 targets.

**Long burst/one target:** 30% of rounds/magazine; inflicts normal damage  $\times 5$ . Counts as one attack.

**Long burst spray:** 30% of rounds magazine; inflicts normal damage from ONE round, hits 1D8 targets. Counts as one attack.

**Empty the entire magazine/one target:** All rounds fired; inflicts normal round damage  $\times 20$ . Counts as all melee attacks/one full melee.

**Empty the entire magazine in a spray:** All rounds fired; inflicts normal round damage  $\times 2$ , hits 2D8 targets. Counts as ALL melee attacks/one full melee. Chance of hitting innocent bystanders is 70%.

### A Special Note About Shotguns:

Shotguns can fire once or twice per melee (double-barrel). It can fire both rounds simultaneously or one at a time. Buckshot scatters, and will strike the specific target plus 1D4 others within its blast area (approximately a 15ft/4.6m area).

## NATURAL ENERGY BLASTS

Supernatural characters whose power enables them to emit energy blasts, whether it be fire, electricity, or other forms of energy, can use their energy attack as often as their combined hand to hand attacks allow. **For Example:** If the creature has FOUR hand to hand attacks, it can fire energy blasts as often as FOUR times per melee (15 seconds). If the character has five or six hand to hand attacks, five or six blasts can be fired. As always the types of attacks can be combined.



# HAND TO HAND COMBAT

The combat system of Beyond the Supernatural is really just an adaption of the rules from *Heroes Unlimited* and *Ninja Turtles*. It is designed to be fast moving and easy to understand. All combat strikes, parries and dodges are resolved by rolling **twenty-sided dice**.

## STEP 1: Determine Initiative

Any time opponents square off for battle, the game master must determine who has the initiative. In other words, who will attack first. Successful *Sneak Attack* or *Long Range Attack* will always have initiative for that melee. Otherwise, whoever *rolls highest* on a twenty-sided die will attack first. In the case of a tie, reroll. Initiative is rolled only once per melee. That roll will determine the pace for that entire melee.

## STEP 2: Attacker Rolls Strike

The next step is for the first attacker to **roll a twenty-sided die**. If the result is a four or less (counting bonuses), then the attacker misses. *Any roll above a four (4) hits the opponent*. But, if the roll is a five (5) or better, *and less than the opponent's Armor Rating (A.R.)*, then damage may be done only to the S.D.C. of the opponent's armor (see A.R./Artificial Body Armor). A roll over the opponent's A.R. does direct damage to the character's S.D.C. and Hit Points. Note that special attacks like Knockout/Stun or Death Blow must be declared BEFORE rolling to strike.

## STEP 3: Defender May Parry, Dodge or Entangle

Any time an attacker rolls a successful hit, the defender can choose to parry, dodge, or entangle. *Parrying* can be done automatically by anyone trained in any form of Hand to Hand combat. That means that the parry can be performed without wasting a melee attack. *Non-combat trained characters will lose their next melee attack every time they parry*.

NOTE: Bullets and energy attacks cannot be parried, but CAN be *dodged*. Defending by dodging or entangling means automatically giving up the next melee attack.

*Entangle* means the character actually pins or snares an opponent's weapons or arm.

The defender can only defend against attacks within his line of vision. Attacks from the rear cannot be parried, dodged or entangled.

## STEP 4: Attacker Rolls Damage

If a successful strike is not parried, dodged or entangled, the attacker rolls for the amount of damage inflicted and adds any damage bonuses. Critical strikes do *double damage*. Combined critical strikes, like a natural twenty and a jump attack, do triple damage. Add the damage bonus to the roll before doubling or tripling. A natural, unmodified, 20 is always a critical strike. A punch inflicts 1D4 damage.

## STEP 5: Defender May Attempt To Roll With Punch

If the attack is a blunt, physical attack (fist, foot, club, staff, etc.), then the defender can attempt to Roll With The Punch. In order to roll with punch, the defender must match or better the attacker's roll to strike. Successfully rolling with a punch means the character takes *half* damage. Successfully rolling with a knockout punch means the character takes double damage, but is NOT unconscious or stunned. Rolling with a death punch

results in loss of half of all remaining S.D.C. and hit points. Failing to roll with punch means taking full damage off of the defender's S.D.C. and/or hit points. The same rules apply to falls as well.

## Continuing The Combat

Once the above is completed, the process is repeated for whoever lost the initiative. So long as the opponents have melee attacks left, the combat continues back and forth. When *all* the attacks or actions per melee round of all opponents are finished, it's time to start a new melee round. Initiative is redetermined at the *beginning* of every melee round. That is to say, that if a character has four attacks per melee, when *all* attacks are used, a new melee round begins.

**Note:** Also see robot and missile rules.

# COMBAT TERMS

**A.R.:** This is a character's **Armor Rating**. The A.R. indicates what an attacker must roll in order to do damage to the character. Any roll of 5, or better, will strike a character with no body armor. Characters with **Artificial Body Armor**, metal armor, bulletproof vests, etc., can easily be successfully attacked by rolls falling under the artificial armor's A.R.; doing damage to the S.D.C. of the *body armor*, but not to the S.D.C. of the defender. Or, by striking above the armor's A.R., damaging the character's personal S.D.C. and/or hit points, but not the body armor S.D.C. **Example:** A defender has a natural A.R. of 5 and is wearing body armor with an A.R. of 8. If the attacker rolls 9 or better, then damage is done directly to the defender. A roll of 5, 6, 7, or 8, would only hurt the body armor, not the wearer. A roll of 1, 2, 3, or 4, would totally miss.

## Damage Table (Basic)

Human Fist	1D4
Human Kick	1D6 or 1D8
Black Jack	1D6
Bull Whip	1D8
Thrown Small Objects	1D4
Falling	1D6 per 10ft
Collision	1D8 per 10mph
Smashing through Glass	1D4
Dropped or Thrown	
Large Objects	1D8 per 100lbs
	1D8 per 40ft, and 1D4 per 4mph

**Death Blow:** An automatic kill. The defender can try to roll with death blow by rolling over the attacker's strike. If the defender is not killed, then the current S.D.C. and hit points are reduced to half. This attack is available only under certain conditions.

**Dodge:** A character dodges by moving out of the way of the attack. Dodging always takes up one attack/action per melee round. To Dodge, the defender must roll higher than the attacker's strike roll on a twenty-sided die.

**Entangle:** A defender can attempt to trap the weapon or arm of an attacker. This is done instead of parrying or dodging, and takes up one attack per melee. An entangle is successful if the defender rolls above the attacker's strike roll. It takes one attack and a roll to entangle to keep an opponent's arm or weapon entangled every melee round. In order to get free, the entangled opponent must roll a dodge against the entangle



roll.

**Hand to Hand Combat:** Fighting skills that provide the characters with attacks per melee, bonuses, and techniques. Characters without combat training have only one attack per melee and have *no* automatic chance to parry.

**Hit Points:** This is the number of points of damage a character can take before dying. Characters don't lose hit points until their S.D.C. is down to zero. A character's base hit points is the P.E. plus 1D6. Another 1D6 of hit points is gained every time the character advances an experience level. Lost hit points are not recovered without medical attention.

**Initiative:** Whoever gets to attack first is considered to have the Initiative. Initiative is automatic in sneak attacks and long-range attacks. In most other cases, each opponent rolls a twenty-sided, highest roll gets the initiative. Rolling for initiative takes place at the beginning of each melee round of combat.

**Kick Attack:** This is a karate-style kick. It is a normal attack that does 1D4 damage for the *untrained*, or higher with hand to hand skills (1D6 or 1D8). Anyone trained in hand to hand combat can do a kick attack.

**Knockout/Stun:** Anyone hit by a knockout or stun attack will be temporarily incapacitated. The victim is not necessarily unconscious, just dazed.

**Jump Kick:** A Jump Kick is performed by leaping completely off the ground and attempting to land feet-first on an opponent. Jump Kick can be used only by those skilled in hand to hand martial arts. The advantage of a jump kick is that it works as a *critical strike* and doubles the normal damage inflicted. The disadvantage of a jump kick is that no other attack may be performed in that melee round (all attacks for that melee are used up in the kick). The jump kick must be the character's first attack of that melee round. For the rest of the melee round, the character can only parry, dodge or move into position.

**Leap Attack:** An airborne assault where the weapons and/or fists are wielded in mid-leap. A leap attack must be made only at the beginning of a melee round and, like the jump kick, uses up *all* attacks for that melee. Usually, only a single strike can be made during a leap attack. However, if two opponents are close together, the attacker can leap between them and strike both of them at the same time; roll to strike for each character. After the leap, the character may not attack again until the next melee round, but can parry or dodge or move into position. Automatic parries work in mid-leap, but dodges are impossible. A successful leap attack is a critical strike and does double damage.

**Long-Range Attack:** By using a long-range weapon from a distance, an attacker can perform an undetected, *first strike*. Provided the attacker is not seen, the defender automatically loses initiative and may not dodge the first attack that melee round.

**Melee or Melee Round:** Exactly 15 seconds. The segment of time combatants have to strike, counter and/or return strike. Generally, playing characters have two or more attacks per melee.

**Multiple Attackers:** Takes place when an opponent is faced by more than one attacker. Characters with hand to hand combat skills can attempt to parry any attacks within their

line of sight. The defender from multiple attackers can strike at only one target at a time (see leap attack for a rare exception).

**Natural Twenty:** This is the result of 20 when rolling a twenty-sided die. A strike with a natural twenty will always be a critical strike. If someone with a strike bonus of +2 rolls an 18, then they have an attack roll of 18 *plus* unnatural, bonus modification; NOT a natural twenty, and is not a critical strike. A natural twenty beats all other rolls and can only be parried or dodged by *another natural twenty*.

**Paired Weapons:** Certain kinds of weapons, such as Sais, Nunchaku, knives, clubs and swords, can be used as paired weapons. Users of paired weapons can strike and parry simultaneously, can do twin strikes against a single target or against a pair of targets, and can parry two, different opponents at the same time. In other words, warriors skilled in paired weapons often can do two actions for every one of their melee attacks. BUT, every time they use twin actions they LOSE their automatic parry.

**Parry:** A defender can attempt to parry most physical attacks. This is done by blocking the attacker's blow with a weapon or hand. Characters trained in hand to hand combat can parry without losing melee attacks. Bullets and energy attacks *cannot* be parried!

**Pull Punch:** The ability to control the force of a hand to hand attack. Usually used to reduce the blow to less than killing force. The character can choose to half damage, quarter damage, a single point or no damage at all. A character must declare a pulled punch, and the player must roll 11 or better on a twenty-sided die; failure means full damage is inflicted.

**Roll with Punch/Fall:** Hand to Hand combat fighters can reduce the damage from blows and falls by rolling. If the defender is successful, then only half damage is taken. Roll with punch/fall does not work against energy blasts, bullets, fire, bladed weapons, psionics or radiation. Victims must roll higher than the attacker's roll. *Falling* characters must roll a 14 or higher, on a twenty-sided die, to roll with the fall.

**Saving Throws:** Occasionally, characters must roll to save against exotic attacks like poison, gas, insanity, psionics, etc.

Lethal Poison	14 or better
Non-lethal Poison	16 or better
Harmful Drugs	15 or better
Acids	No save possible—Dodge!
Insanity	12 or better
Psionics	15 or better for non-psionics 10 or better for psionic

**S.D.C.:** This stands for *Structural Damage Capacity*, which is the amount of damage an object can absorb before breaking. Living creatures also have S.D.C.; it represents their physical resistance to damage. All the S.D.C. of a living thing must be reduced to zero before the hit points can be affected.

#### S.D.C. Table (Basic)

Below are the S.D.C. values for a variety of objects. When an object's S.D.C. is reduced to zero, it is considered broken. Game masters should exercise common sense in applying these values. For example, a normal human cannot break through a vault door with bare fists, no matter how many times natural twenties are rolled.



The S.D.C. of different weapons is applied *only* if someone is actually attempting to break the weapon. A properly wielded sword can inflict or parry many times its S.D.C. On the other hand, using the sword to wedge open a door could easily snap it off.

It is also important to note that the S.D.C. applies to the entire object. A bullet can penetrate many objects with only a small fraction (about 2%) of S.D.C. loss. For example, if a bullet punching through an exterior brick wall hit a target, it would inflict normal damage minus the 4 points of S.D.C. it wasted getting through the wall.

Airplane, Single Engine	400 S.D.C.
Airplane, Jet Airliner	2000 S.D.C.
Boat, Canoe/Rowboat	40 S.D.C.
Boat, Cabin Cruiser	450 S.D.C.
Boat, Cargo Freighter	8000 S.D.C.
Box, Cardboard	2 S.D.C.
Box, Wood Shipping Crate	12 S.D.C.
Box, Metal Shipping Crate	48 S.D.C.
Car, Compact	250 S.D.C.
Car, Luxury	450 S.D.C.
Car, Door Only	150 S.D.C.
Car, Windshield Only	100 S.D.C.
Door, Interior Wood	100 S.D.C.
Door, Exterior Wood	170 S.D.C.
Door, Metal Grill	350 S.D.C.
Door, Solid Metal	600 S.D.C.
Door, Metal Safe	800 S.D.C.
Door, Bank Vault	5000 S.D.C.
Handcuffs, Regular	60 S.D.C.
Handcuffs, Heavy	120 S.D.C.
Lock, Common Latch	40 S.D.C.
Lock, Dead Bolt	100 S.D.C.
Lock, Heavy Padlock	75 S.D.C.
Motorcycle	100 S.D.C.
Truck, Medium Sized Pick-up	450 S.D.C.
Truck, Half-Ton Pick-up	600 S.D.C.
Truck, 18 wheeler	800 S.D.C.
Wall, Interior Plaster	120 S.D.C.
Wall, Exterior Wood	150 S.D.C.
Wall, Exterior Brick	200 S.D.C.
Wall, Cinder Block	300 S.D.C.
Wall, Reinforced Concrete	400 S.D.C.
Weapon, Hard Wood	40 S.D.C.
Weapon, Metal Sword	100 S.D.C.
Weapon, Small Pistol	35 S.D.C.
Weapon, Assault Rifle	75 S.D.C.
Weapon, Artillery Piece	1500 S.D.C.
Window, Ordinary Glass	20 S.D.C.
Window, Plexiglass	35 S.D.C.

**Simultaneous Attack:** Instead of defending with a parry, dodge or entangle, a character can choose to do a simultaneous attack. In this case, the character does not defend (“Go ahead, hit me; I can take it!”) and simply attacks in response. The advantage of a simultaneous attack is that *neither* opponent can parry, dodge or entangle. In all probability, both will take damage. *Exception:* An opponent with paired weapons can engage in simultaneous attack (with one weapon) AND parry (with the other), OR, both the paired weapons can be used to strike with NO parry.

**Sneak Attack:** An attacker may lie in wait (ambush), attack from behind, or sneak up (prowl) on an opponent. If the foe does not discover the attacker, then the sneak attack is successful. The sneak attacker always has initiative, and the defender is not able to parry or dodge the sneak attack.

**Strike:** Anyone attempting to hit an opponent must roll to strike. As with all combat rolls, a roll to strike is made with twenty-sided dice.

**Throw:** Simply, this means throwing a weapon. Rolling to throw is exactly the same as rolling to strike, except that there are different bonuses per weapon type. See Weapon Proficiency.

**NOTE:** A character may use ANY type of weapon, but gets no combat bonuses, such as strike or parry, unless he has a Weapon Proficiency (W.P.) in that particular weapon. This applies to modern and ancient weapons.

## HAND TO HAND: BASIC

- Level 1** Two attacks per melee to start; +2 to pull/roll with punch, fall or impact.
- 2 +2 to parry and dodge.
- 3 Kick attack does 1D6 points damage.
- 4 Plus one additional attack per melee.
- 5 +1 to strike.
- 6 Critical strike on an unmodified roll of 19 or 20.
- 7 +2 to damage.
- 8 Judo-style body throw/flip; does 1D6 damage, and victim loses initiative and one attack per melee.
- 9 Plus one additional attack per melee.
- 10 An additional +2 to pull/roll with punch, fall or impact.
- 11 An additional +1 to parry and dodge.
- 12 An additional +1 to strike.
- 13 Critical strike or knockout from behind.
- 14 An additional +2 to damage.
- 15 Plus one additional attack per melee.

## HAND TO HAND: EXPERT

- Level 1** Two attacks per melee to start; +2 to pull/roll with punch, fall or impact.
- 2 +3 to parry and dodge.
- 3 +2 to strike.
- 4 Plus one additional attack per melee.
- 5 Kick attack does 1D6 damage.
- 6 Critical strike on an unmodified roll of 18, 19 or 20.
- 7 Paired weapons.
- 8 Judo-style body throw/flip; does 1D6 damage, and victim loses initiative and one attack.
- 9 Plus one additional attack per melee.
- 10 +3 to damage.
- 11 Knockout/stun on an unmodified roll of 18, 19 or 20.
- 12 An additional +2 to parry and dodge.
- 13 Critical strike or knockout from behind (triple damage).
- 14 Plus one additional attack per melee.
- 15 Death blow on a roll of natural 20.





## PSYCHIC COMBAT

### ATTACKS PER MELEE

Psychic combat is quick and simple. Each psychic attack counts as one of your character's physical attacks. Thus, if your character has four hand to hand attacks per melee he or she can substitute up to four psychic attacks. Of course, a player can mix the physical and psychic in any combination, three physical and one psi-attack or two physical and two psychic attacks and so on. Most psychic powers are not appropriate for combat, but during a combat sequence each physical and psychic *activity* counts as one *combat action*/attack that melee. The total number of combat actions per melee is equal to the total hand to hand attacks per melee. Note that some psi-abilities require time to prepare which might make any other attacks/action impossible.

**A reminder:** All *player* characters automatically start off with two attacks/actions per 15 second melee. Additional attacks per melee are gained from the hand to hand skills and boxing. **A typical non-player character** gets only one attack per melee plus hand to hand combat and/or boxing skill additions. **Supernatural creature's** number of attacks vary with each individual type, usually two to six attacks per melee. The rules for mixing or substituting psychic attacks still apply.

### SAVINGS THROWS AGAINST PSYCHIC ATTACKS

Psychic attacks which assail the mind, emotions or physiology of a person can always be fought off through the force of one's own will and mental endurance. Psychic attacks that fall into this category include: empathy, empathic transfer, telepathy, mind control, hypnosis, and bio-manipulation. Some psychic powers for which there is no savings throw are telekinesis, levitation, pyrokinesis, presence sense, and see aura.

Even ordinary people have a chance of fighting or saving against a psychic attack. However, those who have psychic abilities have a much better defense against such attack than ordinary people.

To save against a psychic attack a 20-sided die is rolled to mentally parry the attack. A high roll will successfully save against the assault, indicating that the person is NOT affected by the psi-power (no damage or reaction).

**Non-psychics** must roll a 15 or higher to save against psi-attacks.

**The other psychics** need only roll a 10 or higher. Each P.C.C. will indicate the roll needed.

Note that many of the characters also get a bonus to save vs psychic attack. For simplicity's sake **all supernatural creatures** must roll a 15 or higher to save, but most have bonuses to save against psi-attacks.

### INNER STRENGTH POINTS

The use of a particular psionic ability draws upon the astral body or inner strength of the individual. Each specific psionic power will indicate exactly how many I.S.P. are required to perform that ability. When a psionic has exhausted all of his I.S.P. he is unable to perform any more psionic feats until he has had sufficient rest.

**The recovery of I.S.P.** can be done in one of two ways: *Total Relaxation* and/or sleep at a rate of 2 I.S.P. for every hour, or through meditation. *Meditation* is a skill ability in which the

## HAND TO HAND: MARTIAL ARTS

- Level 1** Two attacks per melee to start; +2 to pull/roll with punch, fall or impact.
- 2 +3 to parry and dodge; +2 to strike.
- 3 Karate-style kick does 1D8 damage.
- 4 Plus one additional attack per melee.
- 5 Jump Kick (critical strike). Entangle.
- 6 Critical strike on an unmodified roll of 18, 19 or 20.
- 7 Paired Weapons.
- 8 Leap Attack (critical strike).
- 9 Plus one additional attack per melee.
- 10 Judo style body throw/flip; does 1D6 damage victim loses initiative and one attack.
- 11 An additional +4 to damage.
- 12 An additional +2 to parry and dodge.
- 13 Knock-out/stun on an unmodified roll of 18, 19 or 20.
- 14 Plus one additional attack per melee.
- 15 Death blow on a roll of a natural 20.

## HAND TO HAND: ASSASSIN

- Level 1** +2 to strike. (one attack per melee).
- 2 Plus two additional attack per melee.
- 3 +3 to pull/roll with punch/fall.
- 4 +4 to damage.
- 5 Plus one additional attack per melee.
- 6 +3 to parry/dodge. Entangle.
- 7 Knock-out/stun on an unmodified roll of 17-20.
- 8 Plus one additional attack per melee.
- 9 Kick attack does 1D6 damage.
- 10 Critical strike on an unmodified roll of 19 or 20.
- 11 +2 to strike.
- 12 Death blow on a roll of a natural 20.
- 13 Plus one additional attack per melee.
- 14 +2 to damage.
- 15 +2 to strike.

**Note Hand to Hand Assassin:** This is taught to characters trained by secret organizations (CIA, Mafia, etc.), this is the specialized science of killing. It includes learning Automatic Parry, Pull Punch, Roll with Punch/Fall, Kick Attack (1D6 damage), Knock-Out/Stun, Critical Strike and Death Blow. It does NOT include the ability to do Jump Kick or Leap Attack.



psychic places himself in a simple hypnotic trance. This meditative trance provides maximum relaxation, recovering 4 I.S.P. per hour.

## THE HORROR FACTOR

All supernatural creatures have a horror factor. The horror factor represents either the hideous appearance of the monster or its overwhelming aura of evil and power (or a combination of the two). Whenever a human encounters one of these monstrosities the character must roll a 20 sided die to see whether or not he or she is momentarily stunned by the sheer horror of the thing. This horror factor roll might be thought of as a savings throw or mental parry. Fortunately, the characters only need to roll for the first melee of each encounter, *not* every melee of combat.

**To save against the Horror Factor (H.F.)** the player must roll a 20-sided die. Just like a parry the roll must be equal or higher than the horror factor. For Example: A slobbering creature, with a horror factor of 10, emerges from a crypt. All characters must roll to save against horror. A successful save is 10 or higher on one roll of a 20-sided die. Everybody except poor Tom rolls above a 10. Tom rolls a 6, his character is momentarily stunned with horror.

**A failed roll** means that the character is so overwhelmed with horror that he or she is temporarily stunned. What this translates to in game terms is that the character loses initiative (don't even roll for it), loses one attack/action that melee, is the *last* person to attack/take action and can not defend himself against the creature's *first* attack that melee (no parry or dodge). Fortunately, the character snaps out of the shocked stupor quickly and can join in the combat that same melee. By the second melee the character has completely regained his senses, functioning as normal.





# PSYCHIC CHARACTER CLASSES (P.C.C.)

A psychic character class (P.C.C.) represents the character's psychic energy, how that energy is directed or "focused," and what special abilities, skills and bonuses he or she may possess. Each P.C.C. has its own special focus, strengths and weaknesses. Before selecting a P.C.C. for your character, it is wise to read over each one. Not all have psychic abilities, nor mystic knowledge. I suggest players start with a character that they feel most comfortable with.

## PSYCHIC ABILITIES

Psychic abilities are also known as the paranormal, supernormal and extrasensory perception (E.S.P.). These exceptional powers are, generally, thought to be mental phenomena that are considered, by science, to be outside the range of the normal, five physical senses. Science has recorded some incidents of psychic energies at work, but research is minimal and skepticism is high. Although paranormal abilities are a reality in the world of **Beyond the Supernatural**, they are not commonplace. Everybody has *potential psychic energy*, but very few people recognize that potential and fewer still develop any kind of psychic abilities. Those few, gifted individuals find it safest to keep their abilities secret. For like our real world, this is a modern world of science and technology. A world that regards the supernatural and psychic phenomenon as pure fantasy. It is a world that is too stubborn, fearful and fragile to willingly embark on a journey into the unknown.

Science has closed its open mind to such fanciful nonsense as E.S.P. mind powers. The existence of ghosts and supernatural beasties is even more ridiculous. The pioneers of paranormal research are regarded with disdain; social outcasts of the scientific community looked upon as the misguided, foolish, lazy, dreamers and charlatans.

With this shameful bias prevalent in the revered halls of science, it is no wonder that the truly gifted psychics prefer to remain anonymous. They have little to gain from public admission and much to lose. It is the fear of the unknown that has prompted science to turn a blind eye and a deaf ear to the very real existence of psychic and supernatural phenomena. If science is not ready to embrace such ideas, how will a less informed and less prepared public respond to them? How would most people react to such a monumental change in reality? And it would be a monumental change. The existence of psychic energy and supernatural forces would completely change our perceptions of our world and the forces of nature. Or would it? *Professor Victor Lazlo observed:*

*"Primitive man, past and present, recognized and lives daily with supernatural and paranormal forces. All preindustrial cultures, throughout the world, have their pantheon of demons and evil forces, they all have their shamans, mystics, seers and psychics; people who could see the*

*supernatural better than others. The Chinese may even have understood the concept of natural, ley lines of energy as implied by "Feng-Shui" geomancy. As did the enigmatic builders of the stone megaliths that cover the British Isles. Yet with the advent of science and the industrial age, the supernatural, the paranormal, has been dismissed as superstitious hogwash and thrown out with yesterday's newspaper. Or has it? With much fanfare, civilized man publicly chastises the superstitious foolishness of his ancestors. The supernatural categorically, does not exist. Period. And yet get any small group of people comfortable and at ease with one another, and raise the question of the paranormal. Indubitably, somebody will dare to relate a story about how an aunt or uncle, or parent, sensed a tragedy or a clairvoyant experience, or a "real" ghost story. With a nervous, quiet intensity, another person will share a similar story and another, and another, until somebody dissents loudly or there are no more "real" stories. Then with a laugh, it is all dismissed as weird or silly and pushed away. These stories did not come from disbelievers. It's as if civilized man intuitively knows the supernatural and paranormal does exist, but he dare not admit it. A racial memory, perhaps, that will not let us forget. I believe that the supernatural and paranormal coexists with the normal, as it always has. As our ancestors knew and accepted. As we know, but refuse to accept, and therein lays the danger."*

**The characters** are among the rare few who have, throughout history, been able to tap into their inner psychic energy. An energy that can be molded and directed in many ways, all with spectacular results. It is an energy that draws them into the mysterious and deadly world of the supernatural and beyond.

## THE NINE P.C.C.s

The development of psychic abilities can be intentional, but is more often an inadvertent happenstance sparked by intense focus or desire. There are nine, different psychic character classes (P.C.C.). Each is unique from the other. Of the nine, five have abilities which would be considered classic psi-powers.

**The Latent Psychic** is a character who has not yet developed his psi-abilities. Despite this, the character does possess unusual abilities and a vast reserve of psychic energy. This will usually be an inquisitive individual, full of life, high expectations, and effervescence tempered by innocence.

**The Physical Psychic** possesses psychic abilities that create a physical force or reaction, such as telekinesis, ectoplasm, pyrokinesis and mind over matter, such as making himself impervious to fire. The character is very in tune with his/her body and usually quite athletic and action oriented.



**The Psychic Sensitive** has the painful and wondrous gift of sight; to see and feel the world as few of us ever will. This individual can sense the presence of others, feel evil, see the invisible, glimpse the future and ride the astral plane. He is blessed with a sixth sense that makes him keenly aware of the world around him. Thus, the character tends to be extremely observant, alert, open-minded and inquisitive. But that same awareness also reveals the dark and evil forces that stalk the unsuspecting. This instills the character with a discreet vigilance, cautious and heedful that there is much we do not know.

**The Psi-Mechanic** is an eccentric character with his own view of the world. Like the alchemist of old, the psi-mechanic melds the unknown with the scientific to build machines that will help him tap into his psychic potential. A character tantalized by new ideas and concepts, like a child with a new toy; clever, inventive, resourceful, excited by the sheer adventure of it all and ever driven to explore.

**The Healer** is a psychic whose great gift is the power to heal. He can soothe a burn and mend a bone with a touch. These individuals usually exude a dynamics all their own; tough, confident, strong, reassuring and compassionate.

**The Nega-Psychic** is a study in reverse psychology. An oddity whose disbelief in the paranormal has instilled the character with a natural resistance to its malevolent forces. A bold, brash, confident character with a steadfast resilience to the supernatural.

**The Genius or Natural** is an individual that has turned his psychic focus toward a particular skill or aptitude that has grown into brilliance. It is an effortless proficiency that has become second nature to the character. This raw talent has instilled the person with a confidence (perhaps overconfidence) and exuberance that prompts him to continually question and challenge himself.

**The Parapsychologist** is not psychic per se, but possesses a knowledge and understanding that inexplicably draws him to the unknown. His power is knowledge. A knowledge that helps protect and guide him through the world of the supernatural. The character tends to be naturally studious, reliable, resourceful and inquisitive, and driven by a need to know.

Lastly, there is the **Arcanist or Mage**. A character who has devoted his life to the study of magic and the unexplained. This individual has unraveled the mystery of magic and knows how to use it. His is the power to draw on psychic energy to answer his demands.

There are no attribute restrictions for any of the P.C.C.s with the exception of the parapsychologist and mage/arcanist, both of which require a minimum I.Q. and M.E. This means players are free to select the P.C.C. of their choice. Specific powers, skills and bonuses will be described in the psychic character class section.

## POTENTIAL PSYCHIC ENERGY (P.P.E.)

*Potential psychic energy* (P.P.E.) is a new and important element that is integral to the creation of a psychic character. ALL characters have potential, but it is only the "focus" of that energy that will designate the special psychic abilities. Each character class has a different focus.

Potential psychic energy is the X-factor in human development. In the fictional game context of *Beyond the Supernatural*, everybody has some degree of potential psychic energy. This means everybody has a potential for developing psychic abilities.

Unfortunately, most people have forgotten how to draw upon that secret energy reserve, or do not recognize the psychic potential. As a normal person physically matures with age, the *misdirected* P.P.E. is syphoned off into other, indiscernible areas of talent and interest. By the time the person becomes an adult, the psi-energies have been spent and/or *locked* away as part of the person's permanent psychic energy base. This is what accounts for tiny flashes of psychic phenomena, such as an unreasonable hunch that pays off, or that nagging feeling that your little sister needs you, something is wrong. They are brief instances of somebody unintentionally drawing on their potential psychic energy. Most people dismiss such occurrences as luck or coincidence, and go about their normal business.

Potential psychic energy constitutes the intangible element that provides a person with second sight and true genius. Perhaps the most dynamic example of focused P.P.E. is the idiot savant. A rude misnomer that refers to mentally retarded individuals who possess an unbridled skill that goes far beyond the person's limited capabilities. An adult with the mind of a four year old child, and who can barely manage to dress himself, plays the piano like Mozart. How? The individual will explain that he likes music and can remember any tune he hears. Or what about the human, mathematical ciphering machine who can solve advanced mathematical problems within seconds, without benefit of paper, pencil or calculator, but can not remember the alphabet. This is *potential psychic energy* at its most impressive and most mysterious.

Yet potential psychic energy (P.P.E) is not really an enigma. It is a natural, physical and mental essence that links and binds all life. It is as natural and fundamental as sight, but somewhere along man's development, we forgot how to tap into that natural resource. Perhaps it was the famed, Oriental masters of Zen and mystics, or their Hindu cousins, who first recognized and understood the potential of psychic energy. They learned to merge the mind with the body; to direct and focus the inner self, the "Chi," as an athlete might train and build his body. Once the inner self was conquered, it could be directed in many ways; so it is that we have the legendary Zen masters, fighting monks, martial arts masters, and mystics, each with a different focus and ability.

The key to unlocking P.P.E. is *focus*. An intense, almost unbridled emotion, goal, need or concern. Usually, a goal of great personal satisfaction or importance. The random flashes of insight or apprehension, common to many, is the stirring of psychic energy stimulated by powerful emotions. The idiot savant has unwittingly focused on something that is pleasurable or amusing. The genius has focused on a skill or aptitude that provides great satisfaction, whether it be baseball or quantum mechanics. The ancient Hindu or Oriental masters, who once seemed to have unlocked the secrets of the mind are gone. Their secrets lost, blurred and muddied by the passing of time. Consequently, most psychics develop their abilities independent of each other, without a teacher to guide them. They have inadvertently stumbled onto their abilities and managed to find their own focus to nurture it along. Thus, each focus will be deeply personal and may even contradict the orientation of others with the same or similar abilities.



# THE ARCANIST/MAGE



The arcanist is another one of the few psychic character classes which does not actually possess psychic powers. The arcanist's or mage's power lays in his knowledge of magic and mystic lore. The term arcanist refers to all men of magic regardless of what they may call themselves, mage, wizard, sorcerer, witch, warlock, enchanter, necromancer, mystic, and so on. This character is an educated person with a great love of books, history and mysteries. Formal education frequently includes two to eight years of college studies, but seldom a degree to show for it. The arcanist's thirst for knowledge is too voracious and directed to be slowed or limited by mundane degree requirements

that bore him or fail to serve "his" goals. The arcanist is not concerned with formal recognition nor career advancement, only the mastery of ancient knowledge, the lost arts of magic. Some of these modern mages are driven by power or greed as well, but most are simply *consumed* by the challenge to learn about primeval forces and become their master. It is a challenge that excites and entices the arcanist to probe ever deeper into the mysterious, paranormal world. Each new success, each new fragment of insight, encourages him to explore ever more fervently. That is the character's focus and his power.



Arcanists/mages *not* motivated by a lust for power, wealth, or vengeance, pursue their studies carefully and for personal satisfaction. Some may become acquainted with supernatural forces firsthand, as a result of their research. Others may recognize the existence of dangerous, supernatural evil from their collective studies. While the craven may seek out these maleficent forces for their own, dark, reasons. It is the latter who most often become nefarious mages, or wizards; leaders of cults, covens and societies that work with or worship the fiendish creatures from another dimension. It is the dark mages that call upon magic and supernatural forces to perpetuate evil.

Most arcanist/mage characters played by players will be of a good or selfish alignment and use magic cautiously. This is only logical since a combatant of evil is not likely to be evil himself, and the arcanist knows better than anyone that magic is not a plaything. Magic radiates a very distinctive energy every time it is used. An essence that psychic sensitives and supernatural creatures can sense. The use of magic, even frivolous magic, can alert a creature to your presence or, worse yet, attract it to you. Many supernatural beings can feed on the raw essence of magic, potential psychic energy (P.P.E.), or tap into other people's P.P.E. as power for its own magic. The arcanist's/mage's own vast reserve of potential psychic energy (P.P.E.) is always attractive to supernatural beings. In a similar vein, the arcanist's vast P.P.E. reserve may be perceived as a threat if the creature knows the character can use magic.

## DETERMINING P.P.E. POINTS

The determination of potential psychic energy points is quick and simple. Roll six, six-sided dice (6D6). This is the arcanist's/mage's permanent P.P.E. base. Unlike the other psychic character classes, there are no psi-powers or magic spells to be purchased. The P.P.E. is a permanent psychic power base that the mage can draw on to perform feats of magic. Furthermore, the character's training enables him/her to build that P.P.E. base. Roll one six-sided die (1D6) and add it to the arcanist's P.P.E. beginning with level two.

## THE RECOVERY OF PERSONAL P.P.E.

The Arcanist, like all characters, automatically recovers or regenerates potential psychic energy (P.P.E.) as a natural process. *Half* of the character's P.P.E. will return within 12 hours, *all* P.P.E. will return within 24 hours. Rest and relaxation are *not* a factor. Note that the percentage of P.P.E. is used rather than x-number per hour. This means if an Arcanist has 44 P.P.E., 22 will be recharged and available for use within 12 hours and all 44 P.P.E. will have regenerated at the end of 24 hours.

## ATTRIBUTE REQUIREMENTS

The degree of study and education imposes attribute requirements. To be an arcanist/mage the character must satisfy the following minimum requirements: I.Q. 12, M.E. 10, M.A. 8 (the higher the better).

## SPECIAL TRAINING AND SKILLS

Unlike most characters, the education of the arcanist/mage is too specialized to be rolled on the random education table in the skill section. Instead, the character's interests and years of study have provided a number of skills . . .

Read/Write/Speak Native Language — 98%  
Mathematics: Basic — 98%

Lore: Demon and Monsters (+30% skill bonus).  
Lore: Ghosts and Faeries (+30% skill bonus).  
Lore: Geomancy and Lines of Power (+30% skill bonus).  
Lore: Religion (+30% skill bonus).  
Research (+30% skill bonus).  
Select three science skills (+20% skill bonus).  
Select two technical skills (+20% skill bonus).  
Select four languages (+20% skill bonus).  
Select any two skill programs excluding espionage and military; stage magic can be selected (+20% skill bonus).  
Select ten secondary skills (+5% skill bonus applies to each).

In addition to conventional skill areas, the arcanist/mage develops a handful of skills which directly relate to magic and the paranormal.

## 1. UNDERSTANDING THE PRINCIPLES OF MAGIC

A full understanding of all the various types of magic, their histories, intentions, reasonings behind, purposes, methods, components, rituals and supernatural forces involved. This knowledge enables the character to recognize and understand the purpose of authentic magic symbols, circles, icons, tools, methods and magical paraphernalia, as well as other signs that indicate the use/practice of magic. The character will be able to deduce the probable purpose of the magic and which supernatural forces are likely to be involved. This deep understanding of magic will enable the character to prepare against the forces at work, and stop them or use them himself. **Base Skill:** 70% + 4% per level of experience. A failed roll means the character does not realize the implication of magic or has misinterpreted its meaning. Although the arcanist's knowledge is extensive, the character is not infallible, and may have to consult his own, vast library of archaic knowledge to uncover the true nature of specific magic or unnatural forces. **Note:** The arcanist's full mystic knowledge includes everything contained in the *Magic Section*.

## 2. READ MAGIC

The ability to read a magic scroll or perform a mystic ritual is not as simple as it may sound. Under the right circumstances and frame of mind, anyone can read a spell with mystic results. However, this is pure chance. The arcanist/mage and, to a limited extent, the parapsychologist understand the practical principles of magic. The weaving of a spell is more than the reading or reciting of mere words, just as the invocation of a circle is more than chalk. The use of any magic requires a practice of mental exercises akin to Zen or Oriental meditation. The arcanist knows how to relax, clear his mind, focus by using the spell's words like a mantra, draw on his P.P.E., know exactly how much potential psychic energy will be needed and what effect the magic will have. He can manipulate mystic energies with an ease and speed that belies the years of study, practice and concentration it took to master the mystic arts. While the parapsychologist can read a legitimate spell or scroll, only the arcanist/mage can discern whether it is truly an authentic magic. Only the arcanist/mage can commit a spell to memory and call it forth when desired. Only the arcanist can draw on magic energies quickly and efficiently, whether it be for a spell, circle, or





ceremony. For, while others may hold a fraction of magic knowledge, it is the arcanist/mage who holds a far greater number of its scattered mysteries. **Base Skill:** 80% + 3% per level of experience.

### 3. THE PRACTICED USE OF MAGIC

As already denoted, the character has the knowledge, training and energy to use any type of magic. This is an automatic ability resulting from mystic study and related skills. Specific spells, circles and rituals each have their own requirements and limitations. *See the magic section for details.*

### 4. SENSE MAGIC

The arcanist/mage's familiarity with magic is so intense that he or she can automatically sense when magic energy is nearby. Unfortunately, the ability is not developed enough to pinpoint the source of the magic emanations. Instead, it is a purely unfocused sensation that magic is near (this includes the use of spells). **Range:** Will feel the use or presence of magic within a 120 foot area (36.6m), but can not pinpoint it with this sensory ability.

### 5. RECOGNIZE MAGIC ENCHANTMENT

The ability to recognize the signs of somebody or some object possessing magic properties or being influenced by magic, including charms and possession. **Base Skill:** 50% + 5% per level of experience.

### BONUSES AND VULNERABILITY

#### Bonuses

- +1 to save vs psychic attacks.
- + 4 to save vs possession.
- +4 to save vs magic.
- +4 to save vs horror factor.
- Can use any type of magic.

#### Vulnerability

- Needs a 15 or higher (less bonus) to save vs psychic attacks.
- Has no natural psychic powers.
- Can not sense the supernatural, but can sense magic.
- High P.P.E. base attracts supernatural creatures.



# THE LATENT PSYCHIC

The latent psychic is an interesting anomaly from the usual psychics in one important way; he lacks a definitive focus. Like the other P.C.C.s, the latent psychic has a vast reserve of potential psychic energy, but unlike the others, he has failed to give it a proper focus. Although this limits the character's psychic abilities, it also works to his advantage. 1) The latent psychic can cause both physical and sensitive phenomena. 2) Continues to develop psi-abilities as he/she grows in experience. 3) Retains a comparatively large amount of P.P.E. as a permanent base. This allows the latent psychic the opportunity to operate devices constructed by a psi-mechanic, as well as add his positive P.P.E. to group magic and clairvoyance. On the negative side, the character has few psychic abilities and is an attractive target for creatures which can draw power from his P.P.E. base.

The world around the latent psychic has been enhanced and enlarged by the development of psychic powers. In many respects, the character knows the psychic world better than most. The lack of a definitive focus straddles the character across three, different psychic character classes. He can reach out with invisible, psychic antennae to feel and sense the unseen forces around him, like the psychic sensitive. He can understand and, with instruction, operate the pseudo-scientific devices of the psi-mechanic. The psychic can influence the physical world too; create fire, move objects, and control his body like the physical psychic. However, the heightened understanding is tarnished by the lack of mastery over any one area of focus. His expanded world can sometimes seem too big and too overwhelming, dwarfing him and his insignificant abilities. Consequently, these psychics tend to be full of life and wonder, but often a little insecure.

## DETERMINING P.P.E. POINTS

Figuring out the character's potential psychic energy points is quick and simple. Roll four, six-sided dice (4D6) and add the combined total to ten. This is your total potential, 14 to 34.

The next steps are a little different than the other psychic character classes, because the latent psychic's powers are still developing. Divide the total P.P.E. in half. One half becomes the character's permanent P.P.E. base. The other half can be used to purchase psychic abilities. **Note:** In the case of dividing odd numbers, simply round up to the next even number and divide equally. **For Example:** 25 would become 26 which is divided into 13 for the P.P.E. base and 13 to spend on psychic abilities.

## DETERMINING INNER STRENGTH POINTS (I.S.P.)

All psychic powers require the expenditure of psychic inner strength points (I.S.P.). Every time a psychic power is used, the character must spend a certain amount of I.S.P. Each specific power will indicate exactly how many I.S.P. are needed to perform that ability. When the psychic has exhausted all of his or her I.S.P., rest or meditation will be required to regain the temporarily expended I.S.P. To determine the latent psychic's I.S.P., look at your total P.P.E.

The latent psychic's base I.S.P. is *equal* to his total Potential Psychic Energy Points. **Example:** Flo first determines her P.P.E. She rolls 4D6 and gets 15 plus 10, for a total of 25 P.P.E. (this is before the psi-energy points are divided). Her base I.S.P. is equal to her initial, 25 potential psychic energy points; I.S.P. 25. The psychic gains additional I.S.P. for each level of experience, beginning with second level. The unfocused, random nature of the latent psychic's powers creates wide fluctuations in the amount of I.S.P. gain each level. Roll 2D6 I.S.P. for each new level of experience. **For Example:** At second level, Flo gets to add more I.S.P. to her initial base of 25. Two, six-sided dice are rolled, for a total of 5. The 5 is added to the 25, for a new I.S.P. total of 30. This is repeated for each new level of experience she attains (3, 4, 5, 6, etc.).

## DETERMINING PSYCHIC ABILITIES

The latent psychic's abilities may have a greater range of possibilities, but they are also somewhat random. The first few powers to manifest themselves just surfaced one day. There was no apparent catalyst or intentional focus on them; they just suddenly popped into existence. To determine what those abilities are, roll on each of the following tables.

### One: Minor Psychic Sensitive Abilities

1-20	Death Trance
21-35	Meditation
36-51	Mind Block
52-67	Sense Evil
68-83	Sense Magic
84-00	Sixth Sense

### Two: Major Psychic Sensitive Abilities

1-11	Astral Projection
12-22	Clairvoyance
23-33	Divination
34-44	Empathy
45-55	Mediumship
56-66	Object Read
67-77	See Aura
78-88	Speed Reading
89-00	Total Recall

### Three: Physical Psychic Abilities

1-14	Ectoplasm
15-26	Hydrokinesis
27-39	Impervious to Cold
40-52	Impervious to Fire
53-64	Levitation
65-76	Resist Fatigue
77-88	Resist Hunger
89-00	Summon Inner Strength

Remember those P.P.E. points you divided in half? Well, you can use one half to buy additional psychic abilities, but there are restrictions. The latent psychic is still developing; consequently, the character does not receive all of his psi-powers at once. Instead, they develop as he or she grows in confidence and experience. This means the player must wait until the character reaches **third level** before *one additional psi-power* can be developed/purchased. The player can make his selection from



any of the psychic sensitive or physical psychic abilities. Don't worry about leftover P.P.E. points. One additional psi-ability can be purchased at each, new experience level (4, 5, 6, etc.) until all available P.P.E. points are spent. Remember, the permanent P.P.E. base points can *not* be used to purchase psychic abilities.

Or the player can opt to purchase additional I.S.P. instead of a new psychic power. *Four I.S.P. costs one P.P.E. point.*

## OTHER ABILITIES

### 1. RECOVERING I.S.P.

The recovery of I.S.P. is a natural process which is the same for all psychics. Total relaxation or sleep will automatically restore 2 I.S.P. per each full hour of uninterrupted rest. Meditation is a superior form of relaxation, restoring 4 I.S.P. per each full hour. However, meditation is lost to the latent psychic unless it happens to be one of his/her minor psi-abilities or is purchased at some future level.

### 2. OPENING ONESELF TO THE SUPERNATURAL

The latent psychic can lower his natural mental and emotional barriers to allow supernatural energies to touch him. Although not nearly as receptive as the psychic sensitive, the latent psychic can sense the presence of supernatural evil when "open". **Range** is 100ft/30.5m; one third the range of the psychic sensitive. Also like the psychic sensitive, the character *must* open himself to use any of his *sensing abilities*. Whenever the psychic opens himself, he is vulnerable to psychic attack (15 or higher is needed to save), is momentarily overcome by the psychic emanations (losing initiative and one melee attack), and becomes an attractive target to psychic vampires and ghosts. Opening oneself also permits mediumship/clairsentience to be used.

### 3. BONUSES AND VULNERABILITY

#### Bonuses

- Needs a 10 or higher to save vs psychic attacks, but only when closed to psychic emanations.
- Can sense evil (general) when "open" to psychic sensations; a state of mentally and emotionally lowering one's guard to feel the forces around him. Range: 100ft (91.5m).
- +1 to save vs horror factor.
- +1 to save vs possession
- +1 to save vs magic.
- Psychic attacks per melee are equal to the character's physical attacks per melee.

#### Vulnerability Penalties

- Needs a 15 or higher to save vs psychic attack when open to psychic emanations and when using any psychic abilities.
- The intense concentration required to use any psychic ability causes the character to lose the initiative and one attack or action during the melee round (15 seconds) that he is using his powers. Only one physical melee attack/action and all initiative are lost, whether one psychic ability or multiple psychic abilities/attacks are used that melee. This includes a sensing ability that stretches into several melees. As long as the character is using some aspect of his psi-powers, he loses one melee attack/action and initiative for every melee that

psychic abilities are used.

- Just as the character can sense the presence of evil, that same supernatural evil can sense his presence as a psychic sensitive.





# THE NATURAL OR GENIUS

Not all Beyond the Supernatural characters possess unusual powers, but all do have some special distinction which sets them apart from the rest of humanity. The so-called natural and/or genius is one such non-psychic/non-magic character. This individual exhibits an astonishing aptitude or “natural” ability in a particular area. The uncanny ability might be a skill expertise that far outstrips the person’s formal training or a physical aptitude, such as an outstanding dexterity or physical strength.

What has happened is that the character has tapped into his potential psychic energy (P.P.E.) and has *focused* it into areas of study or physical development. This means the P.P.E. has been transformed into an intellectual or physical emphasis, rather than psychic or magical.

## DETERMINING P.P.E. POINTS

Figuring out potential psychic energy points is simple: *Roll four, four-sided dice (4D4) and add it to 10.* This is your total potential, 14 to 26.

Of the total P.P.E., most of it can be spent to heighten one’s skill(s) abilities. However, at least TWO P.P.E. points must be kept as the character’s remaining base psychic energy. *See Potential Psychic Energy for a full explanation.*

## CONVERTING P.P.E.

The potential psychic energy is converted into skill bonus points. *One P.P.E. point equals a +5% skill bonus.* The bonus, in increments of 5, is a one time skill bonus that permanently increases the skill proficiency. The bonuses can be applied to one or two skills, which can easily provide a first level character with a 98% skill proficiency, or spread out as smaller bonuses (+5% and 10%) to a large number of skills. Or the player may *opt* to purchase one of the *special abilities* explained a little farther down.

The player must convert and apply P.P.E. as part of the initial character creation process. The skill bonuses can be applied to scholastic or *secondary skills*. Skill bonuses are one time, permanent bonuses that can NOT be removed, changed, switched or converted back to P.P.E. at a later time. Once a P.P.E. is converted into a skill bonus it is lost forever. Although it *can* be good to have more than the minimum P.P.E., it is a waste for this character to save a lot of potential, rather than convert it into skill bonuses. P.P.E. points not converted remain permanently frozen as the character’s innate psychic energy and can not be converted into bonuses at a later time. Obviously, education and skills must be determined before a player can divvy up skill bonuses. The skill bonus/level of proficiency gained from focusing potential psychic energy is in no way limited by formal training, so any skill or skills can be increased regardless of education. The maximum skill level possible is 98%. There is always a margin for error. The P.P.E. bonus is in addition to scholastic or I.Q. bonuses.

**An example of P.P.E. conversion and application:** Jack has a character with a P.P.E. of 15. The minimum which must be kept is 2, so Jack has 13 P.P.E. which he can convert into skill bonuses (65% total). He decides he wants to spread the bonuses around to have several higher than normal skills. Jack

decides to add +30% to his surveillance skill (cost: 6 P.P.E. points), +10% to pick locks (cost: 2 P.P.E. points), +5% to detect concealment and +5% to read sensory equipment (both cost 1 P.P.E. point *each*). that’s a total of 10 P.P.E. points. Jack *opts* to keep the last two and adds it to his base for a total of five.

Jack could have just as easily sunk his 13 P.P.E. points/65% skill bonus into two skills or divided the 30% surveillance bonus into three or six small bonuses for other skills. Be careful not to spend more P.P.E. than you have.

Laura has 23 P.P.E., giving her 21 potential points to convert into skill bonuses. She decides to pump 30% into her parapsychology skill (cost: 6 P.P.E. points) and spend the remaining 15 points on one special ability, *computer hacking*. This spends all available P.P.E. points and leaves her with the mandatory 2 as her psychic base.

## SPECIAL ABILITIES

As we saw in the example, players can either enhance existing scholastic and secondary skills or purchase one extraordinary skill ability (skill bonuses can be bought with any P.P.E. leftover). Extraordinary skills occur when the character intentionally or inadvertently focuses his potential psychic energy toward a specific skill or line of thought. This is almost always something the character *loves* to do. The person usually finds it challenging, exciting, fun or provides great satisfaction. The special ability applies regardless of age, schooling or I.Q. Even if the character has an I.Q. of 3 and flunked out of grade school, he/she is a whiz when it comes to that ability.

### 1. ELECTRICAL GENIUS

#### P.P.E. Cost: 16

The focus of this character’s potential psychic energy is electronics. This means he has an intuitive sense and understanding of electricity, circuitry and wiring. However, this “natural” skill is not the equivalent of an electrical engineering skill. Instead, it is more like a bastardized, informal skill that relies on the character’s intuitive sense, more than a comprehensive knowledge of electrical science. Of course, this natural aptitude can be combined with formal education to create a truly impressive skill-combo.

#### ABILITIES

*All are automatic, in addition to scholastic and secondary skills.*

**Basic Electronics:** Natural; no formal training is necessary. Do not select basic electronics as a secondary skill. **Base Skill:** 60% + 5% per additional level of experience.

**Special Bonus:** If the character selects the electrical engineer skill, add a one time bonus of +15%.

**Electrical Hot Wiring:** **Base Skill** is 92%, with *no* increases with experience.

Generally, the term “hot wire” refers to car thieves who *bypass* an automobile’s ignition by tearing out the ignition wires and connecting them to their own ignition or crossing wires to get an electrical charge to start the ignition without a key. The genius character can do this and more!! In addition to hot wiring cars, the character can electrically by-pass alarms, telephone lines, and electrical circuits.



### Hot Wiring/Electrical By-Pass Penalties:

The following penalties apply whenever the character tries to hot wire something. They generally reflect the complexity and difficulty of the job. In some cases, more than one penalty may apply. For Example: A new model car may have an electrical alarm and electrical lock/entry key pad, and must be hot wired for a *cumulative penalty of -20%*. ALL penalties are cumulative.

### Hot Wire/By-Pass Penalties

#### Automobiles

- 0 Cars built before 1980; a snap; time required: 1D4 melees.
- 5% Cars built after 1980; a little more sophisticated; time required — 2D4 melees (that's still only 30 seconds to 2 minutes).
- 5% Auto-alarm; should be disconnected first; time required — 1D6 melees.
- 10% Foreign car; can be tricky; time required — 2D6 melees.
- 10% Auto electric lock or entry key pad; this can be a toughy; time required — 1D4 minutes (not melees).
- 10% Hidden cutoff switch (automobile); time required — 1D6 minutes.

#### Security Alarms

- 5% A common, standard alarm system; a breeze; time required — 1D6 melees.
- 10% A more sophisticated alarm system; time required — 2D6 melees.
- 15% A sophisticated alarm system; time required — 2D4 minutes.
- 20% A superior alarm system; time required — 3D4 minutes.
- 30% A super, superior, complex alarm system (this is the bank, museum and wealthy type of security alarm); time required — 4D6 minutes.
- 10% Not familiar with the type of security system (25% chance); *add* 2D4 minutes.
- 10% Tamperproof; well, supposedly. A failed roll means the alarm is accidentally triggered; *add* 2D4 minutes.

#### Electrical Locks

- 10% A basic lock system; time required — 1D4 minutes.
- 15% A more sophisticated lock system; time required — 2D4 minutes.
- 25% A sophisticated lock system; time required — 3D4 minutes.
- 35% A super sophisticated, complex lock system; time required — 6D4 minutes.
- 15% A timer lock system (set to open only at a specific preprogrammed time; often combined with the sophisticated systems); *add* 2D4 minutes.
- Special. An alarm system is linked with the lock system. See security alarms for penalties and additional time required.

#### Miscellaneous

- 15% Tap into telephone wires.
- 10% By-pass key pad entry system, commercial type; time required — 2D4 melees.
- 20% By-pass key pad entry system, superior industrial type; time required — 1D4 minutes.

- 10% Tamperproof key pad system (often combined with the superior industrial types); *add* 1D4 minutes.
- 15% Hot wire electrical doors or elevators (access panel must be available). 2D4 melees.
- 55% Repair/Work on super-sophisticated circuitry.

The character can also accurately assess the level of complexity, specific aspects of difficulty, and time required to do the job (repair, by-pass, etc.). Recognize quality: 50% + 5% per each additional level of experience. A failed roll means he has greatly underestimated the amount of time/work required.

## 2. COMPUTER HACKING OR HACKER P.P.E. Cost: 15

The focus of this character's potential psychic energy is computer operation and infiltration. Hacking is a slang term for a computer operator who gains access to other computers, usually by telephone modem, and breaks their security code to plunder their data. This skill includes an in depth knowledge of computer programs, useful in pirating computer information.

### ABILITIES

(All are automatic, in addition to scholastic and secondary skills.)

**Computer Operation:** Natural ability; no formal education is required (do not select it as a scholastic skill). **Base Skill:** 88% + 4% per additional levels of experience.

**Computer Programming:** A natural, practiced ability; no formal education is required (do not select it as a scholastic skill). **Base Skill:** 74% + 4% per additional levels of experience.

**Computer Hacking:** The ability to deduce security codes, break the code, pirate data, and install your own security codes. **Base Skill:** 74% + 4% per each additional level of experience.

### Hacking Penalties

The following penalties apply whenever the character tries to gain access to computers and computer programs that are not his own. The penalties generally reflect the complexity and difficulty of the job.

- 10% Break simple security program; time required — 2D4 minutes.
- 20% Break a moderately sophisticated security program; time required — 6D6 minutes.
- 40% Break a sophisticated security program; 4D6 hours.
- 50% Break a super-sophisticated security program; 8D6 hours.
- 60% Break a superior, military security program; time required — 3D4 days.
- 10% Decipher an unknown data code.
- 5% Replace security code with your own. Time required depends on the complexity of the program:  
Simple — 4D6 minutes  
Moderately sophisticated — 2D4 × 10 minutes.  
Sophisticated — 1D4 hours.
- Note:** Presumably, these are *predesigned* codes that the character has designed some time ago and can be just keyed in. A good security program takes weeks or even months to design.



### 3. HUMAN CALCULATOR

#### P.P.E. Cost: 15

A character with this ability has focused his potential psychic energy on numbers and mathematics. He or she just has "a head for numbers." The character can visualize, remember and manipulate numbers in his head with astounding speed and accuracy.

#### ABILITIES

*All skills are automatic and in addition to scholastic and secondary skills*

**Exceptional Mathematics (Advanced):** A natural ability to automatically understand and perform advanced mathematics in one's mind with the accuracy and speed of a calculating machine. This includes simple addition, subtraction, multiplication, division, fractions, percentages, algebra, geometry, calculus, and so on. **Base Skill:** 80% + 4% per each additional level of experience.

**Remember Numbers:** Part of this phenomenal skill is the ability to picture and remember numbers instantly and permanently. This includes phone numbers, addresses, combination lock sequences and so on. The total recall ability is restricted exclusively to numbers. **Base Skill:** 76% + 4% per each additional level of experience. A failed roll means the number is forgotten.

This ability also adds a one time skill bonus to each of the following scholastic or secondary skills:

- Adds +10% to Cryptography
- Adds +5% to Pick Locks
- Adds +5% to Locksmith
- Adds +10% to Chemistry
- Adds +10% to Chemistry: Analytical
- Adds +5% to Physics

### 4. WEAPONS EXPERT

#### P.P.E. Cost: 16

The character has a fondness for the art and craft of metalworking and design as it applies to ancient and/or modern weapons. This focus has led the individual to read and study about weapons, as well as to emulate the old masters in their creation, design and styling. This is an aesthetic and practical appreciation of weapons and old style craftsmanship, which means he or she is not necessarily a gun toting gun bunny.

#### ABILITIES

*All are automatic in addition to scholastic and secondary skills.*

**Make and Modify Weapons:** **Base Skill:** 72% + 4% per each additional level of experience. This special skill means the character can make, repair and custom-modify weapons in which he/she has a Weapon Proficiency (W.P.). **For Example:** A *W.P. Knife or Sword* means the character knows how to properly sharpen, clean and treat the blades, as well as how to repair, balance for throwing and parrying, and even the process and skill to forge the weapon from scratch (a time consuming and physically exhausting job). A **Modern W.P.**, such as *Revolver or Automatic Rifle*, means the character knows how to best clean, unjam, condition, and maintain the weapon, as well as how to lengthen and shorten the barrel, modify the trigger to create a hair trigger, adapt it to handle a larger or smaller slug (limited to two grades up or down, with the largest and smallest calibers

being the limit for that type of weapon. That is to say, a magnum can not be made to fire a rifle shell.), and adapt the principles of the weapon(s) into micronized or special gimmick weapons. The *weapons expert* can also make any and all of the *special cartridges*, from hollow points and Dum-Dums to armor piercing and exploding shells (*See Weapons in the Equipment Section*).

#### Penalties in Creating or Modifying a Weapon

The following penalties apply *whenever* any weapon is built or modified. After the weapon is constructed, the player must roll to see if it works. The base skill is 72%, but then you must subtract all the appropriate penalties. **Penalties are cumulative**, so there are likely to be several combined penalties, especially when working with modern weapons. **For Example:** A revolver has two moving parts: the trigger, and hammer, so a penalty of -10% would apply when modifying a revolver. Thus, the chance for success drops to 57%; still not bad for a first level character.

A failed roll means the weapon does NOT work. PERIOD. Of course, the character can try again and again.

#### Penalties for Modern Weapons

- 5% For each moving part.
- 5% If explosives are involved (very touchy stuff).
- 5% If electronics are involved (another touchy item).
- 10% If miniaturization is involved.
- 10% If the character is using his own design (experimental).
- 15% If the character is not familiar with the weapon.
- 25% Rush job; takes *half the time*, but may be flawed because of it.
- 65% If an energy weapon (i.e. laser, particle beam, plasma, electricity, etc.).

#### Penalties for Ancient Weapons

- 10% Improve balance for throwing or parrying on an existing weapon (somebody else made it). +1 to parry.
- 10% Improve sharpness of a blade (superior). +1 to damage.
- 25% Improve damage capability (usually involves additional mass and better balance). +2 to damage.
- 25% Forge one's own weapon from scratch (good quality). +1 to parry.
- 35% Forge one's own weapon from scratch with superior balance, damage and/or sharpness (add +1 to strike, +2 to parry, and +4 to damage).
- 10% Own design.
- 20% Rush job; takes half the time, but may be flawed.

#### TIME RESTRICTIONS

The amount of time needed to work on a weapon varies with the complexity of the task. The player and game master will have to work out, together, how much time will be needed to do the work properly. Also, the hours of work may have to be spread out over a period of a few days or even weeks. This is precision work and requires a person's full attention.

**A fair formula for determining time** is ONE HOUR for every one penalty point. Two hours per each penalty point if it's the character's own design and add 10 hours for miniaturization. This is the time for the specific work. Additional time spent on research, travel, and getting money for parts and materials, may add a great deal more time than expected.



**Recognize Weapon Quality:** The character is so skilled and familiar with weapons that he can recognize the quality of a weapon by sight, observing it in use and/or by personally examining it. Thus, a character can ascertain the approximate value, condition and quality, as well as its authenticity and approximate age.

**Recognize quality by sight** (not personally examined): 25% + 5% per each additional level of experience.

**Recognize quality by personal examination:** 50% + 5% per each additional level of experience.

**Weapon Skill Bonuses:** The weapon expert is such an authority on weapons that additional bonuses apply. +1 to strike and parry with Ancient Weapons, +1 to strike with Modern Weapons, but *ONLY* weapons that fall into Weapon Proficiencies (W.P.) that the character knows! No bonuses apply if the character does not have that particular W.P.

In addition, select one specific weapon; not just the general type, but a specific weapon, such as a bastard sword, rather than swords in general, or a Model 61 Skorpion (7.65mm) rather than automatic pistols in general. This one very specific weapon is the character's *personal favorite* weapon in the world. No special reasons need to be given nor does the weapon need to be especially lethal or unique. It is simply the character's favorite. James Bond's favorite is a low caliber, automatic pistol. Why? Why not. This one favorite weapon gives the character an additional bonus of +2 to strike and parry (if applicable) whenever it is used.

## 5. BIO-FEEDBACK

**P.P.E. Cost:** 18

The focus of the potential psychic energy is an unique bonding of mind and body, similar to the techniques of Hindu masters who can walk on hot coals. This will allow the character to channel his inner mind, or what the orientals call "chi," to join with the conscious mind to master the physical body. Modern scientists call this bio-feedback.

### ABILITIES

*All abilities are in addition to other skills, attributes, and abilities.*

**Death Trance: Base Skill:** 80% + 4% per level of experience. A form of bio-feedback and meditation that enables the character to fall into a death-like trance. The metabolic rate is so slowed that the body temperature drops, the pulse is undistinguishable and breathing seems to have stopped completely. Without hospital facilities, even a medical doctor is likely to believe the character is dead. Requires 6 melees (90 seconds) of meditative preparation and can be maintained for up to five days without harming the character. In this state of suspended animation, drugs, toxins, and chemical damage and effects are immediately stopped, but will take effect the instant the death trance is stopped. However, the character can purge himself of such impurities, and even heal himself by slipping into a deep, or meditative trance (see cleansing spirit).

**The Cleansing Spirit: Base Skill:** 66% + 4% per each additional experience level. The character can mentally will his body to destroy disease, drugs or chemicals, and heal. This is another spectacular example of bio-feedback/mind over matter. The character is so attuned to his body that he can actually boost

his recuperative power a hundredfold.

To purge his body of poisons or to heal, the character must slip into a deep, uninterrupted trance. While in the trance the character can not engage in conversation, combat or anything else. Although this will leave him vulnerable to attack (it takes one full melee round to snap out of the trance), from all outward appearances the character will already appear to be dead.

**24 hours of cleansing meditation** will negate any poison, drug or chemical in his system and restore 10 S.D.C. or hit points of damage. This includes cuts, bullet wounds, infection, etc. A failed roll means the meditation is ineffective and will require another 24 hours of trance.

**Positive Energy: Base Skill:** 70% + 4% per each additional level of experience. A failed roll means a lack of control, no effect, try again. Yet another bio-feedback ability that instills the character with a super human, physical toughness. To maintain this semi-meditative state, the character must continually exert his will. **Super intense concentration will reduce the character's attacks per melee by half.**

### Bonuses:

- Energy attacks, including heat, fire, electricity, and lasers, do half damage!
- Gases, poisons, drugs and chemicals do half damage and are half as effective (half duration).
- +2 to save vs magic.
- +3 to save vs psychic attacks.

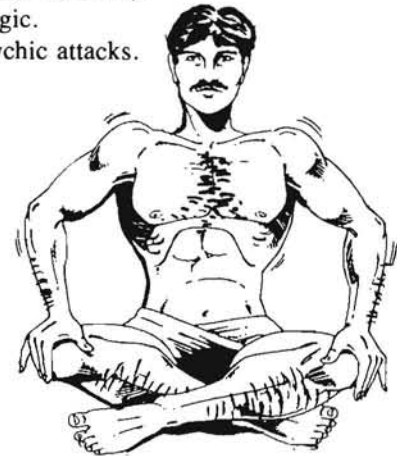

## 6. EXCEPTIONAL PHYSICAL PROWESS

**P.P.E. Cost:** 17

The focus of the potential psychic energy is directed toward physical achievement rather than intellectual. This character has a natural manual dexterity, agility, and coordination that many athletes fail to achieve in a lifetime. The individual may use this physical aptitude in a career as a professional athlete or simply enjoy it in a recreational capacity.

### ABILITIES

*All abilities are in addition to other skills, attributes, and abilities.*

**The character gets the following bonuses and modifications:**

- Add a roll of 1D6 to the P.P. attribute.
- Add a roll of 1D6 to the Speed attribute.
- Add one extra attack per melee.
- Add +2 on initiative.
- Add +1 to parry and dodge.
- Plus a 10% bonus to each physical skill requiring dexterity, such as prowl, swimming, climbing, gymnastics and so on.



## 7. EXCEPTIONAL PHYSICAL STRENGTH

**P.P.E Cost:** 15

Again, the focus is physical rather than intellectual. The character's strength and endurance is of heroic proportions, far outshining the norm.

### ABILITIES

*All are in addition to previous attribute rolls, bonuses and skills.*

The character gets the following bonuses and modifications:

Add a roll of 2D4 to the P.S. attribute.

Add a roll of 1D6 to the P.E. attribute.

Add 1D6 × 10 to physical S.D.C.

**Special:** Can carry 100 times (not 50) P.S. in pounds and can lift 200 times (not 100) P.S. in pounds.

### OTHER STUFF

Determine physical attributes, hit points, alignments, etc. as explained in the beginning of this book.

### Bonuses and Vulnerability

The genius character has used his potential psychic energy by focusing it into an uncommon skill aptitude. However, because the focus is not psychic in nature, it doesn't provide any sort of bonuses or advantages against supernatural forces. Except for his/her area of genius, the character is a normal person.

- Needs to roll a 15 or higher to save vs psychic attacks at all times.
- Has no psychic powers or senses.
- Low base P.P.E. means that the character is less likely to be sought as a P.P.E. power source, sacrifice or target for possession.
- Has no other special bonus.

---

# THE NEGA-PSYCHIC

The nega-psychic is a very odd case. The person who is a nega-psychic has an absolutely unshakable belief that psychic power, the paranormal and supernatural do not exist. No amount of evidence, speculation, scientific confirmation, nor personal experience with the supernatural, will persuade this character to change his conviction. The supernatural and all the other hogwash that goes along with it, like ESP, ghosts, monsters and UFOs, are all nonsense! This character will tenaciously cling to the line of thought that everything *must* have a plausible, logical, scientific explanation. And psychic powers, unknown energy, lines of power, ghosts, and entities ain't logical or scientific! This is the guy who may have spent the last two hours battling with supernatural creatures, witnessed magic and psi-

powers firsthand, and who will definitely state: "Alright, maybe I can't explain it, but it sure wasn't magic or spooks." Then he might add, "Science will figure it out. Maybe not in my lifetime, but they'll put all the pieces together." Swamp gas, practical joke, mass hysteria, weather balloon, sunspots, or hypnosis, are all more acceptable explanations to bizarre phenomena, no matter how lame that train of logic might be. No matter what happens, the nega-psychic (nega means negative) will propose his own solution based on "common sense and science."

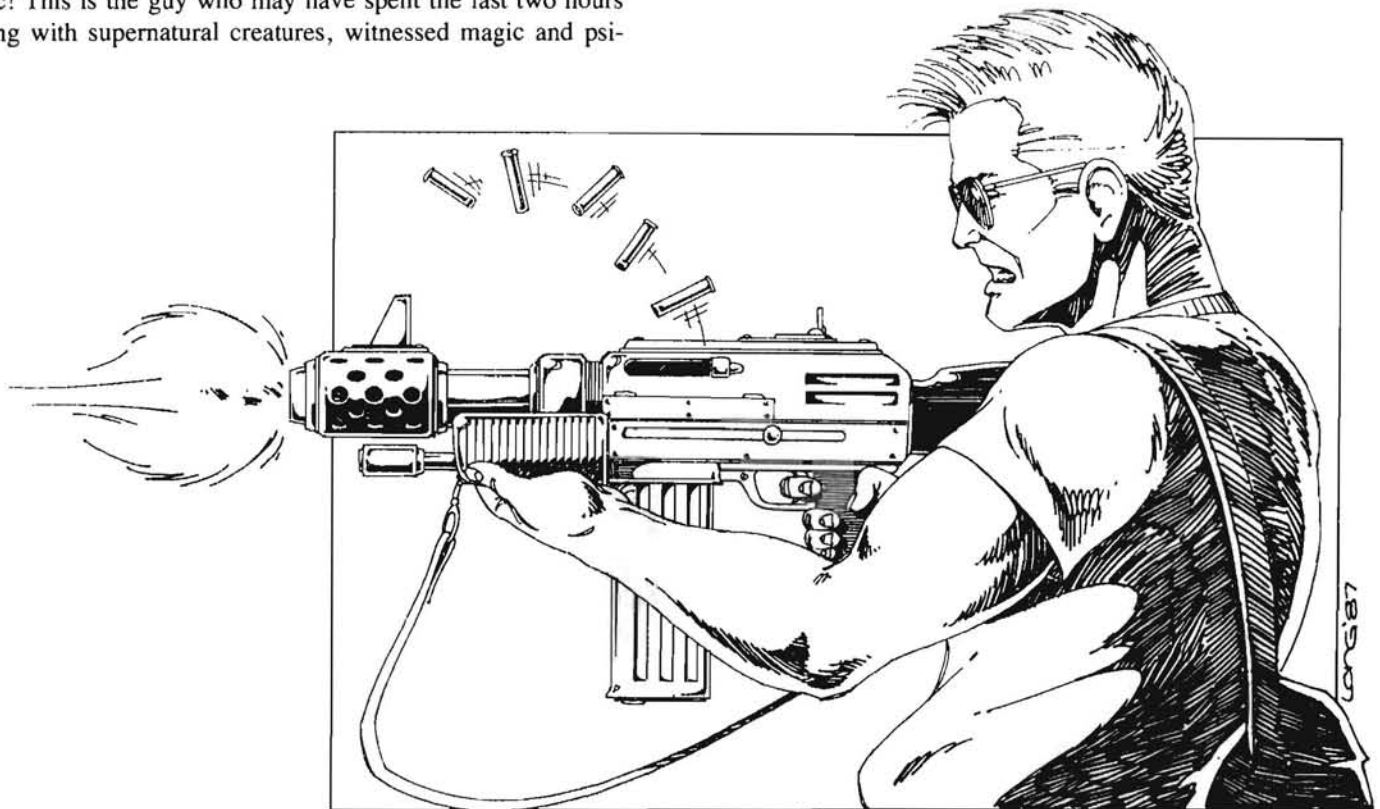



Now there are a lot of people who share the nega-psychic's viewpoint. In a small way, they are like him. But there is a humorous irony that the nega-psychic just can not appreciate. He *is* psychic and uses his psychic energies daily. "Preposterous!" will be the outcry from such individuals. "Don't try to drag me into that poppycock!" And, yet, it is true. The nega-psychic, a term the person will not answer to, is a person who develops his potential psychic energy into a sort of negative energy. This negative energy serves as a psychic shield that protects the character from psychic energies. It is a wonderful, silly, catch twenty-two.

The person has psychic potential, but vehemently denies that potential, this in turn provides an *intense focus* for his psychic energy, which manifests itself as a protective, anti-psychic shield. This anti-psychic shield, powered by the character's own psychic energy, prevents most outside psychic or supernatural influences. This means the character NEVER gets precognitive hunches, NEVER gets clairvoyant images or feelings, NEVER sees a ghost, is incapable of receiving telepathic or empathic communications, is incredibly difficult to possess, and tends to disrupt (negative psi-energy) other human and inhuman psychics around him. Ironically, because he can not be affected personally by psychic forces, it reinforces his conviction that they do not exist.

Nega-psychics often seem to be drawn to the supernatural and psychic phenomena despite their steadfast rejection of its existence. Most nega-psychics are surprisingly tolerant of "deluded individuals" who believe they have psychic powers or are plagued by unnatural forces. A nega-psychic will often associate and even work with psychics or paranormal investigators, especially if there is a scientific basis to the team's operations. The resistance to psychic influences can make a nega-psychic a valuable member to a group who could suddenly find itself the prey of the supernatural creature they seek. On the other hand, the character is often blind, deaf and dumb to supernatural forces. Not only can't the character see or sense the supernatural, he doesn't believe what he sees. Such is the paradox of the nega-psychic.

## DETERMINING P.P.E. POINTS

Determining potential psychic energy points is easy. Roll six, four-sided dice (6D4) and add it to 12. This number is your total potential, 18 to 36.

Of the total P.P.E., eight points must be kept as the character's permanent base psychic energy. All the remaining P.P.E. can be spent on acquiring anti-psychic abilities. For more details about psychic abilities, read that section.

## ANTI-PSYCHIC ABILITIES

The nega-psychics powers are a natural psychic resistance that protects only the psychic.

### Bonuses

- Needs to roll a 10 or higher to save vs a psychic attack. All saves are *automatic* and apply to each psychic attack including hypnosis and nonhostile communications including such as: telepathy, empathy, empathic transfer, object read, bio-manipulation, psychic healing and possession.
- Serves as a disruptive force. In group magic, one nega-psychic P.P.E point will negate 4 positive P.P.E. points of magic power. In a seance, *each* P.P.E point will count as a -4%

success penalty. The negative energies will also reduce the psychic skill success ratio of some psi-powers, like object read, by 10% if the nega-psychic is within 10ft of the other psychic.

Range of *disruptive nega-psychic energy* is 10ft (3m). The nega-force lasts as long as the nega-psychic is within the 10ft range. The nega-psychic can NOT turn off his negative energy. Affects only group magic, ley line powered magic, and group psychic powers (seance) by disrupting the flow of P.P.E.

### Vulnerability

The vulnerability is obvious. The character is resistant to psychic powers, both helpful and detrimental. Furthermore, the character can never understand or imagine the supernatural forces he is pitting himself against.

## PURCHASING ANTI-PSYCHIC ABILITIES

Remember your P.P.E. points? It's time we did something with those. Take your total P.P.E. and subtract 8. The eight must be put aside as your permanent P.P.E. base. You can keep more points for your base of potential psychic energy, but once put aside, they are never again available to purchase special bonuses. However, there are times when the nega-psychic can draw on his base P.P.E. reserve to disrupt mystic or psychic forces. Consequently, players, especially those with a lot of P.P.E. points, might consider adding a few more to the permanent base. **A Player's Tip:** Take your total P.P.E. and subtract the 8 permanent base points. Whatever P.P.E. that remains can be spent on "anti-psychic bonuses." Purchase the bonuses you feel are *crucial* for your character. Check to see how many P.P.E. points remain and, then, consider whether or not you might afford to add a few to your permanent base P.P.E. Remember, these bonuses *are* your character's special abilities. Don't shortchange him.

The nega-psychic can not purchase psychic abilities like most of the other psychic character classes, but can purchase psychic defense bonuses. This enables each individual player of a nega-psychic to distribute bonuses as he or she deems most suitable. Bonuses are measured in increments of +1. Several +1 bonuses can be bought and accumulated in the same category. All bonuses are limited to a maximum total of +6.

### Anti-Psychic Bonuses

- +1 bonus to save vs psychic attacks; **Cost:** 1 P.P.E. each.
- +1 bonus to save vs magic; **Cost:** 2 P.P.E. each.
- +1 bonus to save vs horror factor; **Cost:** 2 P.P.E. each.
- +1 vs possession; **Cost:** 1 P.P.E. each.

**Permanent Mind Block:** Completely prevents telepathy, empathy, empathic transfer and hypnotic suggestion. **Cost:** 6 P.P.E.

**Note:** Unlike most of the other psychic character classes, there is an advantage to adding a few (not a lot, unless you can spare it) P.P.E. to your character's permanent P.P.E. base. Remember, these P.P.E. can, occasionally, be used to disrupt other character's psychic or magic powers.



# THE PARAPSYCHOLOGIST

The parapsychologist is *not* a psychic. He has no special psychic abilities nor magical powers. Instead, the parapsychologist is armed with an open, inquisitive mind and a deep understanding/knowledge of the paranormal and supernatural. He is known by many names; doctor, scientist, psychologist, psychic investigator and ghost hunter. Names that are all appropriate, for the parapsychologist must have a degree in psychology, a background in the sciences and explores the mysterious world of the supernatural.

The focus of the parapsychologist is knowledge. Specifically, knowledge that will unravel the mysteries of the so called paranormal and supernatural. The character will tend to be observant, inquisitive, analytical and serious about his life's devotion. The person's expert knowledge provides insight into the paranormal that enables the character to participate in supernatural phenomena as easily as the arcanist and psychics. As a character, he or she will be invaluable in recognizing and confronting unnatural forces. In many cases it will be the experienced parapsychologist who will act as the group leader, deftly recognizing a supernatural foe and mobilizing those around him to counter it.





## DETERMINING P.P.E. POINTS

The determination of potential psychic energy points is quick and simple. Roll three six-sided dice (3D6). This is the parapsychologist's permanent P.P.E. base. There are no powers to purchase.

## SPECIAL TRAINING AND SKILLS

Unlike most characters, the education of the parapsychologist is too specialized to roll on the random education table in the skill section. Anybody can be a "psychic investigator." It is a sort of catch-all designation that applies to anybody who researches or studies the paranormal and/or supernatural. Parapsychology is a branch of psychology which investigates psychic phenomena; a "paranormal psychologist." This means the character has a Masters Degree in science, a four year program, plus internship, making him far more than one of the curious.

### ATTRIBUTE REQUIREMENTS

The degree of study and education imposes attribute requirements. To be a parapsychologist the character must satisfy the following minimum requirements: I.Q. 10, M.E. 10 (the higher the better).

### SKILLS

The character's years of study automatically provide a number of skills . . .

**Read/Write/Speak Native Language** — 98%

**Mathematics: Basic** — 98%

**Read Sensory Equipment** (+25% skill bonus)

**Biology** (+25% skill bonus)

**Psychology** (+30% skill bonus)

**Parapsychology** (+30% skill bonus)

**Select One Medical Skill** (+25% skill bonus).

**Select Five Technical Skills** (+25% skill bonus).

**Select Three Additional Science Skills** (+25% skill bonus).

**Select Any Two Skill Programs** excluding espionage, and military, but stage magic can be selected. (+25% skill bonus).

**Select Ten Secondary Skills** (no bonuses apply).

In addition to conventional skill areas, the parapsychologist develops a handful of skills which directly relate to the paranormal.

### 1. UNDERSTANDING THE PRINCIPLES OF MAGIC

Magic is studied because it's participants often claim psychic abilities or similar phenomena. A parapsychologist examines all paranormal occurrences and is frequently called upon to investigate an "alleged" psychic medium, witch, wizard or cultist involved in magic or paranormal activity. The ancient psychics, shamen, holy men, sages and prophets were customarily believed to be magic, magicians or linked to supernatural forces. The connection between magic, psychic phenomena, and the supernatural has existed throughout history. Consequently, the principles of magic and the psychological ramifications are a part of the parapsychologist's studies.

The parapsychologist's understanding of magic is by no means as in depth or complete as the arcanist's, but it is quite extensive. The character studies the history of magic, the various types of mystic philosophy, theories, known rituals, social structure and interactions, cults, supposed powers, links to the supernatural

and the purpose behind fundamental rituals and practices. The knowledge is complete enough for the parapsychologists to recognize specific types of magic such as voodoo or necromancy, and even identify specific circles, symbols, magic paraphernalia (ceremonial tools, herbs, components) and other signs that indicate the use/practice of magic. With this knowledge, the character can deduce the probable intent of the magic and the supernatural forces which might be involved. All of this helps the expert psychic investigator to prepare himself mentally and emotionally to combat magical threats and unnatural manifestations.

The parapsychologist's knowledge of magic is pivotal in his investigations of the supernormal, however, it is not enough to enable the character to actually perform magic. Generally, his knowledge deals with the essence of magic and not the specific intricacies of specific spells or rituals. Furthermore, the parapsychologist lacks the mental discipline and sufficient personal potential psychic energy to perform most magic. Knowledge is but one of the important elements of magic. Without the other components it is a puzzle without all its pieces. (*See The Secrets of Magic for details about magic*). **Base Skill:** 50% + 4% per level of experience. A failed roll means the character does not notice the implications of magic or misinterprets the meaning.

### 2. READ MAGIC

Although the parapsychologist can not actively practice magic, he is skilled enough to read spells and invocations from books and scrolls. Likewise, he can perform magic rituals provided that he has elaborate instructions to follow. Unlike the arcanist, master of magic, the parapsychologist will have difficulty focusing and directing the mystic forces. Nor will he know how to draw on his own P.P.E. base or other available sources, such as cult members, ley lines, and so on. However, with proper motivations, instructions and available potential psychic energy, the parapsychologist *can* successfully perform magic. **Base Skill:** 34% + 4% per level of experience if a willing participant. If the character is being forced to do the magic and does not want to succeed there is no possibility of success. If a spell or ritual is read, but the character fails to succeed in his skill roll nothing happens. Try again? **Note:** Low level spells will require two melees (30 seconds) to perform. A ritual will take 4D4 minutes longer.

### 3. RECOGNIZE REAL PSYCHIC POWERS

The character's expertise in psychic phenomena enables him to see through fakery, fabrication, simulations, quackery, and shams. **Base Skill:** 40% + 5% per level of experience.

### 4. RECOGNIZE MIND CONTROL

Including possession, psychic, hypnotic, drug and magically induced manipulation. **Base Skill:** 50% + 5% per level of experience.

### 5. KNOWLEDGE IN THE USE OF EQUIPMENT

Knowledge in the use of sensory and scientific equipment used for paranormal research. **Base Skill:** 70% + 4% per level of experience.



## BONUSES AND VULNERABILITY

### Bonuses

- +2 to save vs psychic attacks.
- +2 to save vs possession.
- +2 to save vs magic.
- +3 to save vs horror factor.
- +1 to save vs mind altering drugs.
- Can read and use magic to a limited degree, but rarely does so because of the danger and instability of magic and the attraction of evil entities.

### Vulnerability

- Needs a 15 or higher (less bonuses to save) to save vs psychic attacks.
- Has no natural psychic or magic abilities.
- Can not sense the supernatural.

## SPECIAL EQUIPMENT

These are items available only to the Parapsychologist, although a few similar items are available in the general equipment list.

### OPTICS

**Infrared Optic Systems** of any kind are extremely effective in seeing invisible supernatural creatures, including ectoplasm, poltergeist, ghosts and entities. Infrared optic systems shoot out an invisible infrared beam of light which will illuminate any invisible creature, as well as enable the person to see in the dark. The problem with infrared systems is that the infrared beam of light is usually pencil thin limiting the area of illumination/vision to a seven foot (2 meter) area. This can make surveying a large area difficult. Also the infrared beam is clearly visible to others using infrared optics. The typical infrared goggle, gun scope, eyepiece and binoculars will cost approximately \$800 to \$2000, *see the equipment section*.

**Ultraviolet Optic Systems** will illuminate ectoplasm and astral travelers. In the latter case the image of the astral body will be blurred, with indistinguishable features (even sex and size is impossible to discern), but clearly evident as a whitish violet shape. Ultraviolet systems can be built into a multi-optics helmet or fashioned into binoculars (the most expensive), gun scopes and eye pieces for \$500 to \$1800. See the equipment section.

**Other Conventional Optic Systems** such as passive night sight, thermo-imagers, illuminating pegs, flares and lights can be used as usual but have no special effectiveness against supernatural beings. Multi-optic systems can be a useful, versatile tool.

**Kirlian Photography:** A special camera system, developed by a pair of Russian scientists, which shows the aura of *living* things or "energy flows." Since the camera reveals auras and related energy it can be used to identify the presence of powerful or *unnatural psychic* and *magic* energy. Thus, a photograph of a possessed person or magically enchanted/entity inhabited object would reveal a large or unusual aura indicating the presence of unnatural forces at work. Unfortunately, the photograph alone can *not* indicate whether the unusual energies are the result of outside psychic or mystic influence or whether it is a natural force. Furthermore, the Kirlian process is somehow flawed, producing a level of inconsistency which prohibits its use as a means of conclusive evidence. The photographic process appears to be only about 60% true/

consistent. Meaning that about 40% of the time a photo of the same living thing will be markedly different than previous photographs. This makes the margin for error incredibly high. However, it can be useful in corroborating evidence from other sources of investigation.

**Kirlian Still Camera:** Cost: \$3200. Film Cost: \$5. Range: 30ft (9.1m).

**Kirlian Video Camera with Monitor (new & experimental):** Cost: (low light system) \$6900. Film Cost (one hour): \$200. Range: 40ft (12.2m).

*The Kirlian Video Camera* can be used to film and record images which can be watched simultaneously on a monitor or at a later time. Unfortunately, the Kirlian video camera still suffers from the usual inaccuracy, but allows for immediate viewing.

### SENSORS

**Portable Magnetometer:** A hand held device about the size of a small, portable T.V., 8 inches long, 6 inches wide and tall, that measures both air and surface electromagnetic energy. The one constant in ley lines, psychic, supernatural and magic phenomena is the presence of electromagnetic energy. This device will measure, record and indicate electromagnetic energy, fluxes/changes in the energy field, and pinpoint the area of energy (not necessarily the source). For example there is always a jump in electromagnetic energy whenever magic is used. Likewise, magic objects, ley lines, haunted houses and megaliths, register unusual amounts of electromagnetic energy (often fluctuating with the time of day or season or the presence of the paranormal). Range: 20ft (6.1m). Cost: \$850.

**Portable Temperature/Humidity Recorder:** Measures and records temperatures from 0 to 100 degrees Fahrenheit (-17.8 to 37.8 degrees Celsius); humidity from 0-100% (accuracy of both are within 2% of scale range). Features 8 inch chart recorder with dual pens, glass window in door, easy chart and pen replacement. Range: 1200 square foot room. Cost: 24 hour recorder — \$450, or seven day recorder — \$550. *Replacement charts cost: \$20 each, pens — \$7 each.*

**Digital Pocket Thermometer:** A lightweight, battery operated thermometer measures both air and surface temperatures in a -60 to +199 degrees Fahrenheit range (-78 to 75.6 Celsius). Features an easy to read LCD display and temperature hold switch. Excellent for locating cold spots in haunted houses. Cost: \$50.

**Pocket Ionization Sensor:** Measures and records positive and negative electric ions in the air. Lightweight with digital read-out. Range: 20ft (6.1m). Cost: \$220.

### OTHER TOOLS OF THE TRADE

**Dust Off:** A small aerosol style canister that allows you to clean anything with a controlled burst of DuPont Freon® gas. Perfect for cleaning lenses, precision mechanisms, artifacts and carved inscriptions. Cleans away ordinary dust, lint, carbon specks and powder. Costs: Regular, 12oz size — \$25. Pocket, 2oz size — 15.

**Pocket Microscope:** The size and weight of a fountain pen. A precision ground four-lense optical system with .001 reticle scale and 10× magnification, .265 inch field. Cost: \$20.



**Electronic Stopwatch:** LED display, full 60 minute range with automatic recycling. **Cost:** \$80.

**Self Igniting Micro Torch:** Fits in one hand, two adjustment valves provides precise control of flame for pinpoint soldering, welding, brazing, etc. Two hour butane gas supply (refillable). **Cost:** \$60. Damage as a weapon is 1D4; range is hand held.

**Optical Tape Measure:** Simply sight object through viewfinder, turn dial until twin images merge into one, then read the distance. Within 96% accuracy. **Range:** 3000ft (914m). **Cost** including carrying case is \$130.

## A NOTE ABOUT EQUIPMENT

Almost any kind of equipment, scientific, industrial, or otherwise, can be purchased, it just may take a while to track it down. This means that, if the character can afford it, anybody can purchase whatever he may desire, with the exception of military, experimental, and explosive equipment, and even these *may* be found through illegal sources.

If the parapsychologist is employed by an *organization* most of his equipment will be provided by the employer. This is almost certain to include all the equipment listed in this section, as well as items from the larger, general equipment section. Items that are not considered standard can be special ordered if the character can present a logical rationale or need for the purchase. In addition to equipment the parapsychologist is likely to have his own, private office, private telephone line, personal computer, access to laboratory facilities, a company car and/or access to other company vehicles, such as truck, van, jeep and motorcycle (airplanes, jets, and helicopters are too expensive to be lent out to most employees). The character may also have a secretary and/or a staff or team of psychic investigators or assistants.

The investigation of psychic phenomena is likely to take the parapsychologist and his team all over the world. Consequently, most organizations will allocate money for travel. To discourage unnecessary travel all expeditions must be approved by administrators of the organization with a typical limit of \$50,000 to \$80,000 per year. However, more funds may be available for especially important or *profitable* investigations.

Most organizations which investigate paranormal phenomena are non-profit organizations sponsored by larger scientific or academic institutions. Others may be sponsored by a philanthropic society or individual, private industry or a private individual (sole proprietor) as a non-profit or *profit* making business. A private business started by the character(s) will have to be financed by the character(s) and equipment purchased.

## OPTIONAL TABLES

The tables which follow can be used when the character and his fellow psychic investigators are employed by an organization. Disregard if self employed.

### TABLE A: THE SPONSORING ORGANIZATION

- 1-13 Philanthropist** millionaire sponsor for personal reasons.
- 14-29 University** sponsored for the advancement of knowledge.
- 30-45 Psychological Institution** sponsored for the advancement of knowledge.
- 46-58 Scientific Research Facility — Private Industry** spon-

sored for personal reasons for profit (financial or promotional value).

- 59-69 Scientific Research Foundation:** Sponsored for altruistic reasons and the advancement of science.
- 70-79 Scientific Research Institute:** Military or government sponsored for the advancement and welfare of the country.
- 80-85 Secret Organization: Geomancers** who believe ley lines are an out of control power source that has inadvertently attracted supernatural forces into our world. They hope to learn more about paranormal phenomena and combat supernatural evil.
- 86-90 Secret Organization: Supernatural Cult** that appears benign even helpful, but whose secret goal is to master supernatural forces for personal power.
- 91-95 Secret Organization: Psychics** striving to learn more about psychic abilities and the paranormal as a “new” science. Motives are purely altruistic; will help any psychics who are willing to accept their aid and further their research.
- 96-00 Secret Organization: Magic Cult** that appears like a strictly legitimate science foundation, but hope to master magic and supernatural evil for power and domination of others. This organization will consider anybody who learns their secret their enemy.

### TABLE B: STATUS WITH SPONSORING ORGANIZATION

- 1-20 Excellent!** Considered to be an exceptional talent. Increase salary by 20%; likely to get special equipment and travel allocation.
- 21-40 Well Liked.** Considered to be one of the best in the field, competent, knowledgeable, resourceful. Increase salary by 10%; likely to get special equipment and travel allocations.
- 41-60 Unpopular.** Considered to be a premadonna maverick who plays by his own rules. Good, competent parapsychologist who is well respected, but has stepped on too many toes. Gets minimal cooperation.
- 61-80 Disliked.** Competent, but does not fit into the organization. Not likely to get special equipment and only gets travel allocations for the worse assignments.
- 81-00 Friendly,** popular, competent parapsychologist. Likely to get special equipment and travel requests.



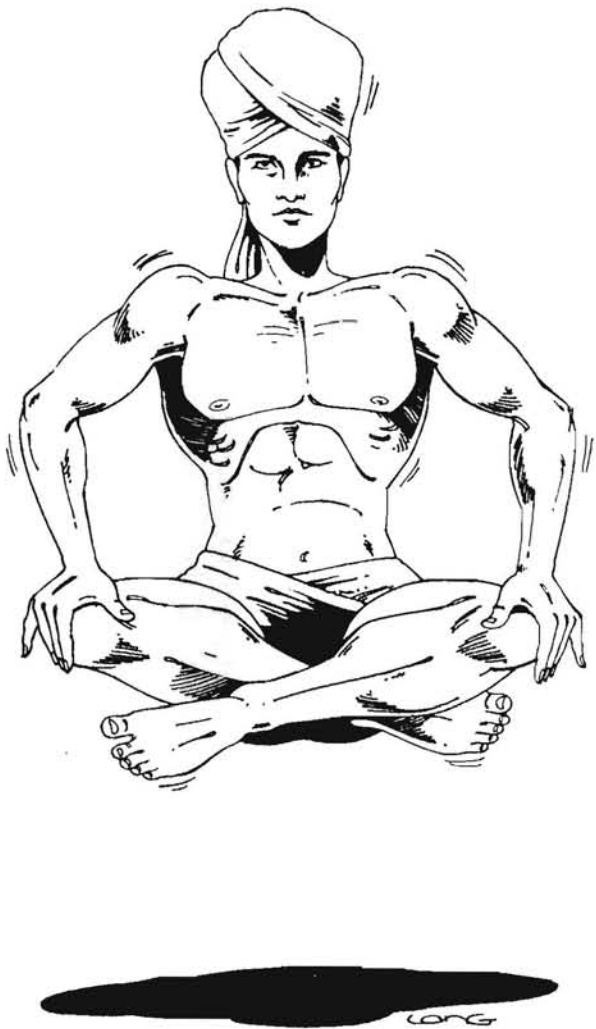

## THE PHYSICAL PSYCHIC

There seem to be two major divisions of psychic power, the sensitive whose extrasensory psi-powers are directed inwardly, and psi-powers that can be directed outward to affect the physical world. Most physical psychic powers induce some sort of physical change or create a physical force that can affect the material world. They are manifestations that can be seen, heard and felt by anyone.

The physical psychic is a person who has focused his potential psychic energy (P.P.E.) into the area of physical psychic phenomena. His is the world of cause and effect. By channeling and focusing his psychic powers, the physical psychic can mentally reach out and touch the world around him, with numerous results. Telekinesis, for example, enables him to open the door or bring himself a book without ever leaving his seat. Pyrokinesis offers control over fire, just as electrokinesis provides a limited mastery over electricity and hydrokinesis, over water. The ability to influence the real world can also be self-directed making oneself impervious to the elements or ignore hunger and fatigue. The physical psychic adds a new dimension to man's mastery over mind and body, and the world around him.

## DETERMINING P.P.E. POINTS

Figuring out potential psychic energy points is easy. Roll four, six-sided dice (4D6) and add the combined total to ten. This number is your total potential, 14 to 34.

Of the total P.P.E., *six points* must be retained as the character's permanent base psychic energy. All the remaining P.P.E. can be spent on acquiring physical psychic abilities. For a detailed explanation of P.P.E. read the section entitled *Potential Psychic Energy*.

## DETERMINING INNER STRENGTH POINTS (I.S.P.)

Before you do anything else, you must determine your psychic *inner strength points (I.S.P.)*. Like psionic powers in our other games, psychic powers draw on the character's inner mental strength or psychic energy. Every time a psychic power is used, the character expends a certain amount of that psi-energy or inner strength (I.S.P.). Each specific power will indicate exactly how many I.S.P. are needed to perform that ability. Major physical phenomena can be quite costly in I.S.P., while others will require only two or three I.S.P. points. When the psychic has exhausted all of his or her I.S.P., rest, sleep or meditation will be required to regain the temporarily expended I.S.P. No powers can be used without sufficient I.S.P.

To determine psychic I.S.P., look at your total P.P.E. points, including the permanent six base points, take that number, double it, and that is your initial I.S.P. The psychic will also gain 10 I.S.P. for every level of experience beyond first level. **Example:** Maryann first determines her P.P.E. She gets 10 points automatically and adds the roll of 4D6. She rolls 15 for a total of 25 P.P.E. To determine her initial psychic inner strength points (I.S.P.), she doubles her P.P.E. number of 25 for a total of 50 I.S.P. At second level, Maryann adds 10 more I.S.P. for a total of 60. The 10 I.S.P. is added again and again for each level of experience she attains (3, 4, 5, etc.). **Note:** The P.P.E. points, themselves (in this example, 25), are *not* doubled. So Maryann's character still has 25 P.P.E., but 50 I.S.P.

## PHYSICAL PSYCHIC ABILITIES

The abilities of the physical psychic can seem deceptively powerful. They are, without a doubt, the most flamboyant of all psi-powers. Unlike the psychic sensitive, whose powers to see, feel and sense emotions, energies and the paranormal are self-contained, the physical psychic directs his powers outward, into the world. He is closed to sensations of the supernatural. He can not feel evil nor see the invisible, because he is linked directly to the physical world. It is his *focus*. It is his strength, as well as his weakness, for despite the physical psychic's impressive powers, he, like most of us, is blind to the supernatural forces around him.

The physical psychic must also exercise caution when using his natural psi-abilities. Unlike the sensitive, these abilities can be observed by anyone. Anonymity can be lost in a single, careless instant. Also, because these powers affect the real world, their thoughtless use can lead to destruction and even death. However, used wisely, they can be a wonderful tool to help others and protect an unsuspecting mankind from supernatural forces.



## 1. RECOVERING I.S.P.

The recovery of I.S.P. is a natural process which is the same for all psychics. Total relaxation or sleep will restore 2 I.S.P. per each full hour of uninterrupted rest. Meditation is a superior form of relaxation and alignment of mind and body; thus, it will restore 3 I.S.P. per each full hour of meditation. The recovery of I.S.P. through relaxation and sleep is an automatic ability and costs nothing. Meditation is a discipline that must be purchased with P.P.E., if it is desired.

## 2. CLOSED TO THE SUPERNATURAL

Although the physical psychic possesses psi-powers, he is not receptive to the subtle sensations of the supernatural world. He is simply not in tune with psychic emanations. However, the physical psychic's presence and powers are a part of the paranormal and, as such, may become known to those who *are* sensitive to such things. This is not all bad. It means the physical focus closes the character off from supernatural forces. While this makes telepathy or clairvoyance difficult and clairvoyance impossible, it also creates a natural defense to possession and psychic attack. This natural resistance coupled with the character's own psi-abilities can make him a dangerous opponent to supernatural creatures. Ironically, this defense also makes the character vulnerable, because he lacks the ability to see or sense the presence of his inhuman foes until they take a visible form or he is guided by a psychic sensitive. This is what makes teamwork essential.

## 3. BONUSES AND VULNERABILITY

### Bonuses

- Needs a 10 or higher to save vs psychic attacks at all times.
- +2 to save vs horror factor.
- +5 to save vs possession.
- +1 to save vs magic.
- Psychic attacks per melee are equal to the character's physical attacks per melee.
- This character is usually attuned to mind and body, providing a bonus of +10%, when applicable, to all physical skills and +8 to physical S.D.C.

### Vulnerability

- Can not sense evil.
- Can not sense the supernatural.
- Can not open oneself to psychic or supernatural emanations including telepathy, clairvoyance, clairvoyance, or other psychic sensory experiences.
- Can not see the invisible.
- Psychic sensitives and supernatural creatures may be able to sense the presence of psychic abilities in the physical psychic.

## 4. PURCHASING PSYCHIC ABILITIES

Remember your P.P.E. points? Good. Let's do something with those. Take your total P.P.E. and subtract 6. The six must be put aside as your *permanent* P.P.E. base. You can keep more points for your base potential psychic energy, but it is not likely to benefit this character. Once added to the permanent base P.P.E., the player can *never* draw on those P.P.E. to purchase additional psi-powers. The following list indicates the psychic abilities which are available for purchase by the physical psychic. Only those abilities listed can be purchased. The P.P.E. cost for

each can be found next to the psi-power. Specific descriptions are located in the psychic abilities section. **A Player Tip:** Generally, the physical psychic will have fewer abilities than the sensitive. However, the physical powers affect the material plane and can be used as offensive and defensive weapons. Be careful not to be lulled into overconfidence by the more spectacular powers. You may find meditation and mind block more beneficial than pyrokinesis.

## AVAILABLE PHYSICAL PSYCHIC ABILITIES AND P.P.E. COST

Alter Aura	Cost: 2 P.P.E.
Bio-Manipulation	Cost: 8 P.P.E.
Death Trance	Cost: 1 P.P.E.
Ectoplasm	Cost: 6 P.P.E.
Electrokinesis	Cost: 5 P.P.E.
Hydrokinesis	Cost: 5 P.P.E.
Impervious to Cold	Cost: 2 P.P.E.
Impervious to Fire	Cost: 3 P.P.E.
Impervious to Poison	Cost: 3 P.P.E.
Levitation	Cost: 3 P.P.E.
Mind Block	Cost: 2 P.P.E.
Meditation	Cost: 1 P.P.E.
Pyrokinesis	Cost: 6 P.P.E.
Resist Fatigue	Cost: 2 P.P.E.
Resist Hunger	Cost: 2 P.P.E.
Resist Thirst	Cost: 2 P.P.E.
Speed Reading	Cost: 2 P.P.E.
Summon Inner Strength	Cost: 2 P.P.E.
Telekinesis	Cost: 6 P.P.E.
Total Recall	Cost: 3 P.P.E.

---



# THE PSI-MECHANIC

The psi-mechanic is a gadgeteer who needs machines as a focal point to draw on his own psychic abilities. This peculiar fellow may be a distant cousin to the alchemist of old, weaving science and psychic together. His psi-devices are working machines that, in a metaphysical way, not scientific, tap into the character's potential psychic energy (P.P.E.) reserve to simulate psychic phenomenon.

The only real drawback is that only he, or possibly another psi-mechanic or latent psychic, can use the devices. A normal man or woman, psychic or mage will be unable to use the psi-device at all.

How or why these machines work for the psi-mechanic is a mystery in itself. Often the working parts do not conform to conventional science or mechanics and may not even have a power source. The most likely explanation is that there are two hidden elements at play. *The first* is the operator's focus (belief in the device), which draws on that person's psychic energies to power the gizmo. It is the psychic's psi-energy that is the real power behind it. This would explain why only another psi-mechanic or latent psychic, both with vast untapped P.P.E., can sometimes use the bizarre machines. *The second*, hidden element is that the psi-mechanic almost certainly etches a psychic imprint into the device. The imprint acts as a combination trigger and psychic circuit board. This would explain why another psi-mechanic can't usually operate somebody else's machine without first getting instructions from the creator.

## DETERMINING P.P.E. POINTS

Figuring out potential psychic energy (P.P.E.) is a snap. Roll four, six-sided dice (4D6) and add it to 10. This is the character's total psychic potential, 14 to 34.

The next step is a little different than the other psychic character classes. *Half* of the total P.P.E. is taken and *kept* as the character's permanent base P.P.E. The remaining half is used to create the psi-machines which simulate psychic powers.

## DETERMINING INNER STRENGTH POINTS (I.S.P.)

All psychic powers require the expenditure of psychic inner strength points (I.S.P.) and the devices of the psi-mechanic are no exception. Each psi-device creates a psychic power. To activate the machine, and therefore use its power, the psi-mechanic functions as the power source, which burns up inner strength points (I.S.P.). The use and cost of I.S.P. is exactly like the normal psychic power. Devices that utilize multiple psychic powers will require the proper I.S.P. total.

**To determine the base I.S.P.**, simply take your P.P.E. number and double it. For example: A P.P.E. of 24 would provide for 48 I.S.P. Note that the P.P.E. remains 24. The character adds 10 I.S.P. for each additional level of experience, beginning with second level.

## BUILDING THE DEVICES

The character can build a device that emulates a broad range of psychic abilities. When the machine is built, the psi-mechanic is permanently drained of potential psychic energy (P.P.E.). The expenditure of P.P.E. creates the psychic circuit board which





gives the machine its power. The psychic ability is identical to the natural psi-power it is meant to emulate. The P.P.E. cost to instill a device with a specific power is listed, along with the available abilities. Each individual machine will require P.P.E. However, to build a duplicate device costs half the original, listed, P.P.E. cost. Multiple psi-powers can be built into the same device, but is costly in both P.P.E. to create it and I.S.P. to operate it (each power will require I.S.P.).

The machine should suggest some scientific common sense. For example: To see the invisible, the character would devise some type of goggles or glasses. Perhaps a psychically “enhanced” pair of infrared goggles, or passive night sight goggles with some sort of extra doohickey (psi-powered) which would offer conventional optical enhancement, as well as the psychic, see the invisible. A psychic sensory device meant to detect a supernatural presence might include multiple psi-powers, such as presence sense, sense evil and/or sense magic. This sensory device is likely to look and function like a Geiger counter or other modern sensory machine, with displays, counters, dials, indicators, and even sound. A device to induce clairvoyance, empathy or telepathy will probably fit over the head like a helmet or wild looking, thinking cap. To invoke a mind block or cause levitation might require a headband-like device or another helmet/hat. Hydrokinesis may demand an underwater eye mask with unusual attachments or a shower head or well . . . , I think you get the idea.

#### Cost and P.P.E.

Initially, at first level, the character can use as much as half the total P.P.E. to build one or several psi-machines. Remember, once spent, the P.P.E. is permanently gone. Also, remember that the other half of P.P.E. becomes the character’s permanent base and can *never* be used for building. Any available P.P.E. that is not spent on building can be saved for later use. At second level, the character gets an *additional ten P.P.E.* for building and, at each of the following levels, an additional 2 to 8 P.P.E. (roll 2D4 for each level).

A psi-mechanic can immediately build a new device each level, or opt to save all or part of the additional P.P.E. available from level advancement. The saved P.P.E. can be used to create or duplicate a device at any time. For Example: Alex reaches second level of experience and gets ten more P.P.E. for building. He saves those P.P.E. At third level, Alex rolls 2D4 for additional building P.P.E.; he rolls a 5. He now has a total of 15 P.P.E. that he can use to build psi-machines. Alex spends 4 points on the creation of a new device, keeping the remaining 11 for an emergency. Sure enough, his goggles to “see the invisible” get smashed, but Alex has eleven P.P.E. to re-create a *duplicate* pair of goggles. The first pair cost Alex 4 P.P.E., but even though it takes him just as long to build a new pair, the *duplicate* goggles cost *half*; 2 P.P.E. This leaves nine P.P.E. still in reserve. Remember never to use the permanent P.P.E. base. To avoid confusion, it may be wise to log available building P.P.E. separately.

The only restrictions are that: 1. Enough P.P.E. is available (do not use the permanent base). and 2. The character spends at least 48 hours building the item. That’s 48 hours of actual labor, not just two days time. A typical days work building a psi-machine is 10 to 12 hours, which would mean four or five days of intense activity. A rush job will require more work hours per day (16 maximum), which will result in a finished machine in three days, but an exhausted psi-mechanic.

## WHO ELSE CAN USE THESE DEVICES?

The psi-mechanic is the only person who can use his odd creations without effort. Non-psychics can not use them at all. Nor can a psychic sensitive or physical psychic or supernatural creature. However, with proper instruction and practice, a latent psychic or another psi-mechanic *may* also be able to use the device.

The chance of successfully using a psi-machine *without* personal instruction from the creator is slim. *Another psi-mechanic* has a 20% chance of figuring out its function and operation (two tries are possible). A *latent psychic* has a mere 12% chance to successfully use a psi-device (add +5% if the latent psychic uses an object read on the item).

Personal instruction by the psi-mechanic who created the device, plus 24 hours spent on focus and practice, will yield the best possible chance for success. Under these conditions, another psi-mechanic has a 55% chance of making the device work, although his own design philosophies limit his receptiveness. A latent psychic, who is not blocked by his own design ideas, has the best chance; 64%. Either character gets only *one* try. A failed roll means that, despite the private tutelage and practice, the character has no chance of ever mastering that particular psi-device. There is one more person who may be able to use the machine, with instruction. A child 6 to 12 years old has a 32% chance of successfully using the item. **NOTE:** All percentile rolls should be made in front of the game master. Scientists and mechanical engineers will not be able to find a way of making the device work by conventional means.

## BONUSES AND VULNERABILITY

### Bonuses

- **Special:** Needs a 13 or higher to save vs psychic attacks.
- +2 to save vs horror factor.
- +10% on each mechanical or electrical skill. The character’s mechanical inclinations provide an extra one time, skill bonus applicable to *all* conventional, building-type skills including demolitions, demolitions disposal, and secondary skills like basic mechanics and pick locks. This bonus is in addition to I.Q. and/or educational skill bonuses.
- Recognize magic or psychic enchantment of objects and devices (not people) — 40% + 5% per each additional level of experience.

### Vulnerability

- The most obvious weakness is that the character has no special psychic powers without the aid of his devices. On the other hand, the character can use both sensitive and physical abilities.
- Because of the unusual focus, the psi-mechanic does not have any innate sensitivity nor the usual battery of bonuses. However, the character tends to be extremely clever and resourceful.
- The large reserve of P.P.E. makes him or her an inviting target of supernatural forces.

## PSYCHIC POWERS AVAILABLE TO THE PSI-MECHANIC

Any one or more related abilities can be built into one of the psi-mechanic’s machines. The power(s) function as described in the psychic ability section and still require the usual number if I.S.P. The machine is powerless when the psi-mechanic temporarily uses up his I.S.P.



Each available power indicates the P.P.E. cost to build it into the psi-machine.

#### Sensitive Abilities

Clairvoyance (+ 10% skill bonus)	Cost: 4 P.P.E.
Empathy	Cost: 4 P.P.E.
Empathic Transfer	Cost: 6 P.P.E.
Mind Block	Cost: 2 P.P.E.
Presence Sense	Cost: 4 P.P.E.
See Aura	Cost: 2 P.P.E.
See the Invisible	Cost: 4 P.P.E.

Sense Evil	Cost: 2 P.P.E.
Sense Magic	Cost: 4 P.P.E.
Telepathy	Cost: 6 P.P.E.

#### Physical Abilities

Electrokinesis	Cost: 6 P.P.E.
Hydrokinesis	Cost: 4 P.P.E.
Impervious to Cold	Cost: 2 P.P.E.
Impervious to Fire	Cost: 4 P.P.E.
Resist Fatigue	Cost: 2 P.P.E.
Telekinesis	Cost: 6 P.P.E.

## THE PSYCHIC HEALER

The pages of history contain the stories of countless shamans, holy men, wizards, priests, prophets, and psychics, with the ability to heal. Like the other psychic character classes, the ability to heal is a matter of channeling or focusing psychic energy. In some respects the psychic healer is a *physical* psychic, because the character can physically influence others. But the distinctiveness of the healer's powers places him in a category of his own.

There are many theories regarding the powers of the psychic healer. Some believe the powers are an advanced form of hypnosis or power of suggestion. That, via the power of suggestion, the psychic actually stimulates the focus of the person's own psychic energy (P.P.E.) to heal himself.

Another theory is that the healer can manipulate physical matter, much like the physical psychic. In this way, the psychic directs his own psi-powers to induce healing, and other biological





effects in others. Whatever the cause, the psychic healer *can* heal himself and others.

To use his powers, the healer seems to require greater concentration to focus the healing energies. This means that the psychic will often lapse into a meditative trance or semi-trance, and must usually spend a half minute (2 melees/30 seconds) or more to perform a successful healing.

## DETERMINING P.P.E. POINTS

A simple process in which the player rolls four, six-sided dice (4D6) and adds the combined total to ten. This is your character's total psychic potential, 14 to 34.

The psychic healer must retain at least four P.P.E. points as his/her *permanent* base psychic energy. These four P.P.E. points can not be spent on acquiring psi-abilities.

## DETERMINING INNER STRENGTH POINTS (I.S.P.)

Before you do anything else, you must determine your character's psychic *inner strength points* (I.S.P.). Like the psionic powers in our other games, psychic powers draw on the character's inner mental strength or psychic energy. Every time a psychic power is used the character expends a certain amount of that psi-energy or inner strength (I.S.P.). Each specific power will indicate exactly how many I.S.P. are needed to perform that ability. Major psychic phenomena can be quite costly in I.S.P., while others will require only two or three inner strength points. When the psychic has exhausted all of his I.S.P., he will need sleep, rest or meditation to regain them. No powers can be used without sufficient I.S.P.

To determine your character's I.S.P., look at your total P.P.E. points, including the permanent base four points, take that number, double it, and that's your initial I.S.P. The psi-healer also gets an additional 10 I.S.P. for every level of experience beyond first level. Example: Tom has selected the psychic healer as his P.C.C. He first determines the character's P.P.E. He automatically gets 10 P.P.E. and adds to it the roll of 4D6. He rolls a 13, for a P.P.E. total of 23. To determine the healer's initial I.S.P., Tom takes the total P.P.E. number, 23 and doubles it, for a total of 46. At second level, Tom's healer adds another 10 I.S.P. to his 46, for an I.S.P. total of 56. The 10 I.S.P. is added again, and again for each additional level of experience he attains. Note: The actual P.P.E. points, in this example 23 — are *not* doubled. So Tom's character still has 23 P.P.E., but 46 I.S.P. at level one.

## PSYCHIC HEALING ABILITIES

The psychic healer has a number of psychic abilities which can be purchased with P.P.E. points. All abilities reflect a control and knowledge of the mind and body. Most of these abilities will demand intense concentration, force of will and immense psychic energy. These conditions may restrict the character's use of his psychic abilities.

### 1. RECOVERING I.S.P.

The recovery of I.S.P. points is a natural and automatic occurrence. Total relaxation and/or sleep will restore I.S.P. at a rate of two (2) per each full hour of rest. Meditation is a superior form of relaxation, focusing and aligning the mind and body in harmony. Thus, it will restore four (4) I.S.P. per each full hour

of meditation. Unlike the other P.C.C.s, meditation is an automatic ability of the psychic healer and does *not* have to be purchased.

### 2. MEDITATION

The art of meditation is a mental discipline whereby the mind dwells upon a single notion to gain insight into the inner nature and meaning of the universe and to relax, achieving an inner harmony and focus. The psi-healer must utilize meditation to focus his healing powers. It is a relatively simple process (once mastered) that the healer can achieve almost instantly (one melee). Meditation does *not* require any I.S.P.

### 3. BIO-REGENERATION

The psychic healer is so in tune with his mind and body that he can will his body to destroy disease, drugs or chemicals, and heal. Although reminiscent of the "natural" psychic's cleansing spirit ability, the healer's ability to bio-regenerate is an even more spectacular example of mind over matter.

To purge his body of poisons or drugs, the character slips into a deep, uninterrupted, meditative trance. The progress of the unwanted chemicals will stop almost immediately (within one melee/15 seconds). However, to permanently stop its effects, by destroying the polluting substance, will require a full 20 minutes of deep concentration. During this time the character can not engage in combat or even conversation, leaving him vulnerable to attacks. Indeed, the bio-regeneration trance slows the metabolism down so low that the character will *appear* to be dead.

The same process is used to heal wounds and injuries, from broken bones to cuts and bullet wounds. However, the recuperative trance is even deeper, and once begun, the character can not be roused from it until he wills it. The healing is incredible. The metabolism is slowed to a crawl almost immediately (1D4 melees), regulating the flow of oxygen and preventing further blood loss. After one to four hours of meditation (roll 1D4), the spectacular healing process begins. From this point on, the bio-regenerative process will restore 2 S.D.C. and one hit point for every *two hours* of meditation. Cuts, bullet wounds and burns will be completely healed within the week, leaving only the tiniest scarring. Broken bones will heal 10 times faster than normal. Limbs and organs which are completely destroyed or removed can *not* be regenerated. If the character loses a hand or an eye, it is lost forever.

The healer can also make himself *resistant* to fire/heat and cold (does half damage). 1D4 melees of preparatory concentration is required. Because concentration must be maintained for the duration of the resistance, the character loses initiative and half his melee attacks.

### 4. BONUSES AND VULNERABILITY

The character's bond with life makes him keenly aware of pain and suffering. These individuals are rarely of an evil alignment, tend to be extremely sympathetic and compassionate to others, and detest all forms of torment, physical and psychological. This harmonious fusion with life provides a number of bonuses.

- +8 to save vs possession.
- +4 to save vs mind altering drugs.
- +4 to save vs poisons/toxins. ● +1 to save vs magic.
- +15% to save vs coma/death. ● +1 to save vs horror factor.
- Needs a 10 or higher to save vs psychic attacks.



- Most psychic abilities require a great deal of time and concentration. Whenever a healing ability is used the healer is completely defenseless to physical attacks, meaning he can not dodge or parry without breaking contact with his patient and failing to heal.
- Not open to psychic sensations such as sense evil.

## 5. PURCHASING HEALING ABILITIES

Remember your P.P.E. points? Let's do something with them. Take your *total* P.P.E. and subtract four. The four must be put aside as the character's *permanent P.P.E. base*. Players can elect to keep more P.P.E. as a psychic energy base, but once put aside, they can never again be used to purchase psi-abilities. There is little advantage for the healer to save additional P.P.E. The remaining P.P.E. points can be used to purchase psi-healing abilities. The list that follows indicates which psychic powers are available and the P.P.E. cost for each. The descriptions for each of the powers is found in the psychic ability section. **A player's tip:** You must select psychic diagnosis to use psychic surgery. Although *no* biology, chemistry, medical or science skills are required, they will add to the character's overall effectiveness as a healer.

## AVAILABLE PSYCHIC HEALING ABILITIES AND P.P.E. COST

Deaden Pain	Cost: 2 P.P.E.
Exorcism	Cost: 3 P.P.E.
Healing Touch	Cost: 5 P.P.E.
Impervious to Cold	Cost: 2 P.P.E.
Impervious to Fire	Cost: 2 P.P.E.
Increase Healing	Cost: 4 P.P.E.
Induce Pain	Cost: 3 P.P.E.
Induce Sleep	Cost: 2 P.P.E.
Psychic Diagnosis	Cost: 3 P.P.E.
Psychic Surgery	Cost: 5 P.P.E.
Psychic Purification	Cost: 2 P.P.E.
Resist Fatigue	Cost: 2 P.P.E.
Suggestion (Hypnosis)	Cost: 5 P.P.E.



N. O'Connor & S. R. Bissette 11/87



# THE PSYCHIC SENSITIVE

There are many real phenomena in the world which operate on principles which science does not yet understand. One such area is the paranormal or supernormal phenomena, of which extrasensory perception (ESP) and psychic experiences are a part. The paranormal is generally regarded as psychic or mental abilities or manifestations that are outside the range of known human abilities.



The psychic sensitive is a person whose potential psychic energy (P.P.E.) has been focused into areas of psychic development. The sensitive has a greatly enhanced perception of energy and forces that most normal people can not even understand, let alone perceive. It is a heightened sensitivity to the unknown that the Hindu call "the third eye". A figurative representation of the sensitive's ability to "see" what others can not. Actually, this is a very apt analogy, for the psychic sensitive can, indeed, glimpse into the world of the supernatural. They can feel the presence of evil, just as you or I would feel the chill of the wind. The stench of evil, supernatural entities is as tangible as the smell of a rotten egg; while the aura of magic flickers unmistakably, like a candle in darkness. Yes, the third eye. A sixth sense that provides a very different view of our world and the beings that inhabit it.

## DETERMINING P.P.E. POINTS

Figuring out potential psychic energy points is easy. Roll four, six-sided dice (4D6) and add the combined total to ten. This is your total potential, 14 to 34.

Unlike some of the other psychic character classes, the sensitive must *retain* at least EIGHT P.P.E. points as their base psychic energy (these 8 can not be spent on acquiring abilities). See *Potential Psychic Energy* for a full explanation about P.P.E.

## DETERMINING INNER STRENGTH POINTS (I.S.P.)

First, you must determine your *inner strength points* (I.S.P.). Players of our other games will correctly recognize a strong similarity between psychic abilities and I.S.P. with psionics and

I.S.P. They both function on the same game-playing principles, although the determination of *psychic abilities and I.S.P.*, and the powers themselves are somewhat different than the old psionic standards. Like psionics, the psychic's inner strength points (I.S.P.) reflects the character's inner mental strength. Every time he or she uses a psychic ability requires concentration and willpower, drawing on the astral body or inner strength of the individual. Each specific psychic power will indicate exactly how many I.S.P. are required to perform that ability. When the psychic has exhausted all of his I.S.P. he is unable to perform any more psychic feats until he has had sufficient rest.

To determine psychic I.S.P., look at your total P.P.E. points, including the permanent eight base points, take that number, double it and that's your initial I.S.P. The psychic also gains 10 I.S.P. for every level of experience beyond first level. **Example:** Roger first determines his P.P.E. He automatically gets 10 P.P.E. plus the roll of 4D6, he rolls a 12 for a total of 22 P.P.E. To determine his character's I.S.P. he doubles the P.P.E. number of 22 for a total of 44 I.S.P. At second level, Roger adds 10 more I.S.P. for a total of 54. The 10 I.S.P. is added again, and again as each new level of experience is attained (3, 4, 5, 6, etc.). **Note:** The P.P.E. points, themselves, (in this example 22) are not doubled. So Roger's character still only has 22 P.P.E., but 44 I.S.P.

## PSYCHIC SENSITIVE ABILITIES

There are an array of powers that can manifest themselves in a psychic sensitive, however, all are relegated to mental and information gathering type abilities. The psychic sensitive is not unlike a living, human, sensory receptacle that can pick up, pinpoint, interpret, recognize and understand, supernatural energies. None of the sensitives powers have any extensions in the physical world. That is to say, the sensitive can *not* influence physical matter. He or she can not make a coin dance across a table, heal a wound, make a candle flicker or levitate into the air. Such powers are physical manifestations of psychic energy (see the physical psychic) and are not available to the sensitive.

### 1. RECOVERING I.S.P.

The recovery of inner strength points is a natural and automatic occurrence. **Total relaxation and/or sleep** will restore 2 I.S.P. for every one hour of rest. **Meditation** is a superior form of relaxation and alignment of mind and body; thus, it will restore 4 I.S.P. each full hour of meditation. Recovering I.S.P. through relaxation or sleep is an automatic ability and costs nothing. Meditation is a skill that must be purchased with P.P.E., if it is desired.

### 2. SENSE SUPERNATURAL EVIL (general)

The psychic sensitive is keenly aware of the world around him, thus, he or she will feel or sense any major disturbances nearby. One such disturbance is the presence of supernatural evil. ALL supernatural beings radiate their alignment. Most are evil. The sensitive can feel that evil like an icy chill cutting through him. The sensation is unmistakable, costs no I.S.P., and is automatic, meaning the character does not have to open himself, nor be actively trying to sense anything. The evil will wash over the character, warning him like an alarm. **Range:** Senses any *supernatural* evil within 300ft (91.5m). However, the sensation is very general. The location and nature of the evil is unknown. To pinpoint and identify its source, the psychic



must open himself and use the “sense evil” psi-power.

### 3. OPENING ONESELF TO THE SUPERNATURAL

The *root* of the psychic sensitive’s power is his inquisitive nature and willingness to drop his natural mental and emotional defenses to satisfy that curiosity. By opening oneself, the psychic enlarges his picture of the world feeling the forces at play within it. In an open state the character can continue to sense evil (general) as described previously, but also other sensations. He can “feel” *large* fluxes of energy; magic power, P.P.E. (the use of over 80 P.P.E. whether it be magic or psychic), the presence of ley line energy, electro-magnetic energy, electrical energy and the general location of intersecting underwater streams (a ley line related energy). **Range:** 600ft area (183m).

**The psychic must open himself to use any of his sensory abilities including:** empathy, empathic transfer, clairvoyance, divination, mediumship, object read and telepathy. To close oneself off is like putting on a gas mask and then trying to smell an aroma. To experience and identify the smell the gas mask must be removed. Likewise, the psychic sensitive must let down his guard to experience psychic sensations/emanations, just as one must take off the gas mask to smell. Of course, the risk of removing protective psychic defenses means the character is vulnerable to the very forces he hopes to identify.

1. The very act of opening up requires concentration, just as you might have to focus your full attention to identify an unusual smell, and even more concentration to pinpoint its place of origin/locale. When a psychic sensitive opens himself to these supernormal vibrations he must concentrate, sometimes lapsing into a semi-trance. His psychic sense, or “third eye”, sees and feels sensations that momentarily overwhelm the other five senses. Reaction time and awareness are reduced, just as it may take you a moment to realize someone is talking to you when you are deep in thought. Consequently, the character loses any chance for initiative and forfeits one attack/action per melee.
2. Opening to the paranormal means intentionally lowering one’s natural defenses. This makes the character an open target for psychic (psionic) attacks. No bonuses to save vs psychic attack. The character must roll a 15 or higher to save. This is especially true of empathic and telepathic onslaughts. **Note:** Possession is an exception. The sensitive psychic *has all bonuses* to save against possession by a supernatural entity!
3. Sensitivity to the supernatural is a two-way street. It is only a matter of time before the inhuman being senses the presence of the psychic sensitive character. Since the sensitive is likely to be the only person to identify, see and locate the creature, he is equally likely to be its first target. *Players* will be wise to remember this and take measures to protect the sensitive in their group.

### 4. BONUSES AND VULNERABILITY

#### Bonuses

- Needs a 10 or higher to save vs psychic attacks when closed to psychic emanations.
- Recognizes possession of others by supernatural forces — 50% + 5% per each additional level of experience.
- Recognizes magic enchantment — 35% + 5% per each additional level of experience.

- Can automatically sense the presence of supernatural evil within 300ft (91.5m). Also, see the sense evil psi-ability, which is infinitely more precise.
- +3 to save vs horror factor.
- +3 to save vs possession.
- +1 to save vs magic.
- +3 to save vs mind altering drugs.
- Psychic attacks per melee are equal to the character’s physical/hand to hand attacks per melee.

#### Vulnerability Penalties

- Needs a 15 or higher to save vs psychic attacks when open to psychic emanations and when any abilities are being used.
- The intense concentration required to use any psychic ability causes the character to lose the initiative and one attack or action during the melee round (15 seconds) that he is using his powers. Only one physical melee attack/action and all initiative are lost whether one psychic ability or multiple psychic abilities/attacks are used that melee. This includes a sensing ability that stretches into several melees. As long as the character is using some aspect of his psi-powers he loses one melee attack/action and initiative for every melee that psychic abilities are used.
- Just as the character can sense the presence of evil, that same supernatural evil can sense his presence as a psychic sensitive.

### 5. PURCHASING PSYCHIC ABILITIES

Remember your P.P.E. points? Good. Let’s do something with those. Take your total and subtract 8. The eight must be put aside as your permanent P.P.E. base. You can keep more points for your base potential psychic energy, but once put aside they can never be spent to purchase other psychic powers ever again. The following list of psi-powers are available to the psychic sensitive. The P.P.E. cost is indicated for each. The *descriptions* can be found in the *Psychic Ability section* elsewhere. **A Player’s Tip:** You may find the psi-powers of *sense evil* and *mind block* of incredible value.

### AVAILABLE PSYCHIC ABILITIES AND P.P.E. COST

Astral Projection	Cost: 4 P.P.E.
Clairvoyance	Cost: 4 P.P.E.
Death Trance	Cost: 1 P.P.E.
Divination	Cost: 3 P.P.E.
Empathy	Cost: 3 P.P.E.
Empathic Transmission	Cost: 6 P.P.E.
Meditation	Cost: 1 P.P.E.
Mediumship/Clairsentience	Cost: 3 P.P.E.
Mind Block	Cost: 2 P.P.E.
Object Read/Psychometry	Cost: 4 P.P.E.
Presence Sense	Cost: 3 P.P.E.
See Aura	Cost: 3 P.P.E.
See the Invisible	Cost: 3 P.P.E.
Sense Evil	Cost: 2 P.P.E.
Sense Magic	Cost: 2 P.P.E.
Sixth Sense	Cost: 2 P.P.E.
Speed Reading	Cost: 2 P.P.E.
Suggestion (Hypnosis)	Cost: 5 P.P.E.
Summon Inner Strength	Cost: 4 P.P.E.
Telepathy	Cost: 5 P.P.E.
Total Recall	Cost: 4 P.P.E.



# ORDINARY PEOPLE (Optional!)

If a player would rather play a relatively normal person, without psychic abilities or magic, that's fine. Simply ignore Step Three: Selecting a Psychic Character Class, and Step Four: Occupation (except for conventional occupations). Everything else, attributes, hit points, determining education, selecting skills, alignments and rounding out one's character remain unchanged. The only real difference is that the character has no psychic or magic abilities.

So what is an ordinary Joe doing hunting down the supernatural? Presumably, the character has been inadvertently drawn into the supernatural world by a fluke paranormal experience. The normal character had no interest in the supernatural, nor any intention of becoming involved as a psychic investigator (or combatant against supernatural forces). But something changed all that. Perhaps the character's family was the victim of some "thing" and he or she is the sole-survivor. Or, perhaps the individual is looking for somebody who has disappeared, fallen victim to a supernatural force. Or, the character may have experienced a paranormal experience that has forever changed his/her view of the world and hopes to learn more. Still another possibility could be that the person has inherited a magically enchanted object, or mystic book or haunted house. As you can see, the motivation for investigating the supernatural can be endless.

## DETERMINING P.P.E.

Figuring out the permanent base potential psychic energy (P.P.E.) is basically unchanged. There are no powers to purchase, so the result of the dice rolled is the permanent P.P.E.

**Child**, 13 years old or younger — 6D6 + 6 P.P.E.

**Teens**, 14 to 19 years old — 4D6 P.P.E.

**Adults**, 20 years old or older — 3D6 P.P.E.

The amount of potential psychic energy changes as the person grows and matures, both physically and emotionally. A child has the greatest P.P.E. because he or she is a walking energy reserve full of unbridled potential. A child has an intensely curious mind, wide open to ideas that jaded adults would reject without a moment's thought; like a ghost or monster living in the attic. To a child the world is a new and wondrous place, where anything is possible. Since a child has not yet focused his/her potential in any area his/her psi-energy is at full capacity. Sadly, this glow of potential psychic energy can become the target of supernatural beings or iniquitous mages who would feed on or tap into the child's potential to supplement its own power. However, because the child has a huge amount of P.P.E. he/she can unwittingly draw on a natural psychic resource. Psychic abilities natural (and unrecognizable) to kids are:

**Clairvoyant Flashes** — 50%, usually a dream or feeling.

**Sense Evil** — 60%; a bad feeling about somebody or someplace.

**Sixth Sense** — 60%; a sudden awareness of danger.

**See the Invisible** — 66%; sees ghosts and others, normally invisible entities.

None of these psychic abilities can be controlled or intentionally directed (most kids won't even realize anything is unusual), they just happen from time to time. The percentile number indicates the likelihood of a manifestation under stressful conditions or when threatened by supernatural evil.

A person's potential psychic energy dissipates with age as the view of the world becomes narrower and specific interests occupy one's attention (focus). A **teenager** is still growing, developing, thus, his/her P.P.E. is a little higher than a physically mature adult. An **adult** in this case, anyone older than 20 years of age, is fully developed physically and has expended P.P.E. on little areas of momentary focus. Non-psychic or magic adults always have the least P.P.E. Oddly enough this can work to the person's advantage. Much like the *nega-psychic*, the ordinary adult and teenager has unconsciously closed himself to paranormal energies. This lack of susceptibility, and the dogma of science, helps reinforce the general belief that supernatural, is superstitious tom-foolery. This means that people usually do not sense, see or experience the paranormal except in tiny unnoticeable ways like a bad feeling about something or a sense of *deja vu*. See *bonuses and vulnerability*. Kids on the other hand, are like open circuits waiting for something to plug into.

## BONUSES AND VULNERABILITY

### Vulnerability for Children

- Open to paranormal sensations especially clairvoyance, sense evil, sixth sense, see the invisible. This also makes them particularly vulnerable to empathy, telepathy, hypnosis, and magic charms.
- No bonuses vs psychic attack.
- Needs a 15 or higher to save vs psychic attacks.
- No bonuses vs horror factor.
- Attractive to supernatural creatures as a source of P.P.E. power.

### Bonuses for Children

- Sense of belief is 100% commitment.
- +1 to save vs possession.
- +1 to save vs magic.

### Bonuses for Adults and Teens

- +2 to save vs possession.
- +2 to save vs psychic attacks.
- Physical modifications (bonuses):
  - Add 1D4 to hit points.
  - Add 2D4 to S.D.C.
  - Add 1D4 to Speed.

### Vulnerability for Adults and Teens

- Needs a 15 or higher (13 or higher with +2 bonus) to save against psychic attacks.
- Being closed to psychic sensation means the ordinary person is oblivious to psychic, magic and supernatural phenomena.
- No bonus to save vs magic, other than a possible P.E. attribute bonus.
- No bonus to save vs horror factor.
- Negative attitude toward psychic abilities will reduce the success ratio of clairvoyance, object read and mediumship by 8% when within 10ft of the psychic using those powers.

### Experience Levels

The normal human uses the same experience table as the *Nega-Psychic*.



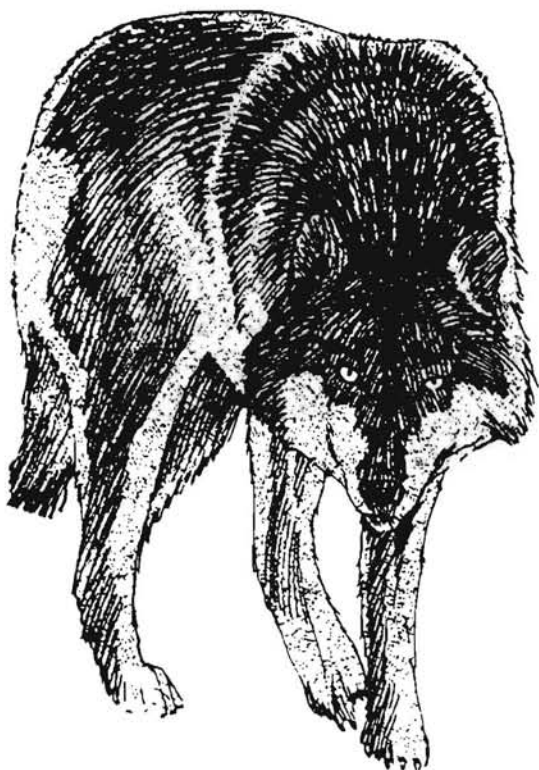

## A NOTE ABOUT MAN'S FRIENDS; ANIMALS

Most larger mammals seem to have innate natural psychic senses that warn them about the presence of supernatural forces. As odd as it may seem animals associated closely with humans on a friend/helper level have the most pronounced psi-abilities.

Dogs, cats and horses exhibit the greatest extrasensory perception. Each animal has the following abilities:

- See the Invisible
- Sense Evil
- Sense Magic
- Sixth Sense
- Empathy (receives)

Each ability is an automatic instinct that helps the animals *avoid* the supernatural. **Range:** 600ft area (183m). The animals will sense the use or presence of these forces in the area, but also in specific people or creatures as well. The animal's reactions will always be the same; intense nervousness, jumpiness, whimpering, hissing, growling, howling and alertness when the energies are sensed to be in the area. If possible the animals will try to leave the area and will flee if they get the opportunity. Only a *loyal* canine companion may stay with his human friend/master. When *cornered* face to face with the source of magic or supernatural forces the animal will attack and attempt to flee. A dog or cat will raise the hairs on its back, bare fangs and growl or hiss in a menacing warning. A horse will whine, stomp and rear. If the person or creature does not back off the animal will attack. The cat and horse will attack only to make a path of escape and to let the unnatural being know that they know its true essence. 1-60% of the time all canines will attack to kill! The remaining 40% of the time (61-00) the animal will flee. **Note:** Dogs and cats can not be trained to sniff out magic or supernatural creatures. Their natural instinct is to run away. They will NOT

search out these forces for anybody or any reason and will flee as soon as the opportunity arises.

*The animal's use of psychic abilities is automatic and natural. Consequently, they do not get an I.S.P. rating.*

## Animals and Magic

All living creatures have potential psychic energy points. An arcanist, especially evil ones, may sacrifice an animal to get its potential psychic energy. Remember, the P.P.E. of all creatures doubles at the moment of death and an arcanist can capture and use that unleashed energy. *See the Secrets of Magic pages 92, 93 and 94.*

## The following is a list of animal types, their P.P.E., and Hit Points:

- Birds (small) — 1D4 P.P.E./1D4 Hit Points
- Birds of Prey — 2D6 P.P.E./1D6 Hit Points
- Mouse — 1D4 P.P.E./One Hit Point
- Rat/Other Rodents — 2D4 P.P.E./1D4 Hit Points
- Domestic Cat — 3D4 P.P.E./2D4 Hit Points
- Wild Cats (Predator) — 3D6 P.P.E./6D6 Hit Points
- Large Wild Cats (Lion/Tiger) — 4D6 P.P.E./6D6 + 20 Hit Points
- Small Canine — 2D6 P.P.E./3D6 Hit Points
- Large Canine — 3D6 P.P.E./4D6 + 10 Hit Points
- Wolf — 4D6 P.P.E./6D6 + 15 Hit Points
- Bear — 2D6 P.P.E./3D4 × 10 Hit Points
- Mustelid (Weasel/Badger) — 2D6 P.P.E./4D6 hit Points
- Cattle — 4D6 P.P.E./4D6 + 10 Hit Points
- Horse — 4D6 P.P.E./6D6 + 10 Hit Points
- Monkey — 2D6 P.P.E./2D6 Hit Points
- Ape — 3D6 P.P.E./4D6 + 6 Hit Points
- Lizard — 1D6 P.P.E./1D6 Hit Points
- Fish — 1D4 P.P.E./1D4 Hit Points

## Saving Throws

Animals, like humans, get an automatic roll to save vs magic attacks, however, all such saves are -4.

Animals also get to save vs psychic attacks and must roll a 15 or higher to save.

**Note:** An incapacitated animal prepared for sacrifice is helpless and an automatic kill (death blow).



# Descriptions Of Psychic Abilities

## AN ALPHABETICAL LIST OF ALL PSYCHIC ABILITIES

### Healing

Deaden Pain  
Exorcism  
Healing Touch  
Impervious to Cold  
Impervious to Fire  
Increase Healing  
Induce Pain  
Induce Sleep  
Psychic Diagnosis  
Psychic Purification  
Psychic Surgery  
Resist Fatigue  
Suggestion

### Physical

Alter Aura  
Bio-Manipulation  
Death Trance  
Ectoplasm  
Electrokinesis  
Hydrokinesis  
Impervious to Cold  
Impervious to Fire  
Impervious to Poison  
Levitation  
Meditation  
Mind Block  
Pyrokinesis  
Resist Fatigue  
Resist Hunger  
Resist Thirst  
Speed Reading  
Summon Inner Strength  
Telekinesis  
Total Recall

### Sensitive

Astral Projection  
Clairvoyance  
Death Trance  
Divination  
Empathy  
Empathic Transmission  
Meditation  
Mediumship/Clairsentience  
Mind Block  
Object Read/Psychometry  
Presence Sense  
See Aura  
See the Invisible  
Sense Evil  
Sense Magic  
Sixth Sense  
Speed Reading  
Suggestion  
Summon Inner Strength  
Telepathy  
Total Recall

## PSYCHIC HEALER ABILITIES

### Deaden Pain

**Range:** Immediate proximity, touch or within 3ft (0.9m).

**Duration:** One hour per level of experience.

**Length of Trance:** Two minutes (8 melee rounds).

**I.S.P.:** 4

The ability to deaden pain can be used as a pain killer which temporarily negates existing pain or as an anesthetic to be used for surgery.

### Exorcism

**Range:** Immediate area, touch or within 8ft (2.4m).

**Duration:** Instant, if successful.

**Length of Trance:** 30 minutes of preparation and 6D6 minutes with the possessed person or animal. **Note:** can only exorcise the living.

**I.S.P.:** 10

The healer can perform a rite of exorcism that uses psychic energy to expel the loathsome being from its mortal, host body. A completely successful exorcism will free the victim of the supernatural force that controls him and send it back to its own non-earthly world. A partially successful exorcism will drive the evil force out of the possessed person or animal, but does *not* send the damnable thing back to its own dimension. Thus, it can try to possess the healer or flee to wander the Earth in search of new victims. An exorcism can only be used on living persons or animals whose bodies are inhabited by a supernatural entity or creature. *Also see possession.*

**Roll to determine success for an exorcism** at the end of the time period. **First**, roll to see if the being has been expelled from its victim's body. **Success ratio:** 28% + 7% per each additional level of experience. **Second**, roll to see if the thing is forced back into its own dimension. **Success Ratio:** 21% + 7% per each additional level of experience. A failed roll means the creature can remain in our dimension, but it must leave the area and can not possess the same individual for at least six months. **Note:** The chance of a successful exorcism on a *nega-psychic* is reduced by half, as is the success ratio for sending the being back to its own dimension. The same is true of some of the more powerful supernatural beings.

During the exorcism the possessing force can use whatever powers it may have, as well as physical attacks or any special



psychic abilities of its host body. Fortunately, the rite of exorcism weakens the creature, reducing its number of attacks per melee by half. It is wise to always have one or more assistants to help defend against the being's attacks and actions. Sedating the physical host body will immobilize it, but will not prevent psychic attacks or the creature's use of its natural powers. Too many assistants or spectators can be a liability, for the creature may attempt to flee by possessing one of them. An exorcism can be attempted on the same individual as often as the healer desires.

## Healing Touch

**Range:** Touch.

**Duration:** Instant, with lasting effects.

**Length of Trance:** Two minutes (8 melee rounds).

**I.S.P.:** 6

The healing touch is a remarkable healing ability that can instantly heal cuts, burns, bruises and similar physical wounds. The touch restores 1D8 hit points *or* 2D6 S.D.C. The healing touch can only be used on other living creatures, never on himself.

## Impervious to Cold

**Range:** Self

**Duration:** 20 minutes per level of experience.

**Length of Trance:** 1D4 melees for preparatory meditation.

**I.S.P.:** 2

A mind over matter discipline which enables the character to suffer absolutely no ill effects or discomfort from exposure to even extreme freezing conditions.

## Impervious to Fire

**Range:** Self

**Duration:** 3 minutes per level of experience.

**Length of Trance:** 2D4 melees for preparatory meditation.

**I.S.P.:** 4

Another mind over matter discipline enabling the psychic to endure intense heat, fire, boiling water, hot coals, and so on, without suffering pain, damage or scarring. Magic fires inflict *half* damage.

## Increased Healing

**Range:** Touch or within 3ft (0.9m).

**Duration:** 2D4 days.

**Length of Trance:** 1D6 hours.

**I.S.P.:** 10

The healer is able to stimulate *another* person's healing energies, dramatically increasing one's recuperative powers. Hit points and S.D.C. recovery are double the normal professional treatment rate.

## Induce Pain

**Range:** Touch or within 6ft (1.8m).

**Duration:** As long as the trance is maintained.

**Length of Trance:** One melee/15 seconds is needed to prepare, before pain can be inflicted. The length of the pain inducing trance is completely up to the psychic.

**I.S.P.:** 2 per minute.

**Savings Throw:** Standard

The ability to inflict a terrible, debilitating pain without phys-

ically damaging the living creature. Victims are -6 to strike, parry and dodge, lose initiative, skills are -30%, and attacks per melee are half. There is a good chance of the victim passing out after five minutes of continuous pain; 50% + 10% per each additional minute.

## Induce Sleep

**Range:** Touch or within 6ft (1.8m).

**Duration:** One hour per level of experience (or until awakened).

**Length of Trance:** Two minute preparatory meditation.

**I.S.P.:** 4

**Savings Throw:** Standard; plus unwilling victims are +5 to save vs psychic attack.

This is not an offensive ability, but is intended to be a recuperative power to induce sleep on those who are ill, exhausted, or an insomniac. The person will fall into a normal, restful sleep from which he can be easily roused. Unwilling victims of the induce sleep psi-power get a +5 bonus to save (because this is not the intent of the ability) and can not be involved in combat at the time.

## Psychic Diagnosis

**Range:** Touch or within 3ft (0.9m).

**Duration:** Immediate knowledge.

**Length of Trance:** 2D4 melees of meditation.

**I.S.P.:** 4

**Savings Throw:** None; except for the nega-psychic, standard.

The psychic healer can sense physical pain, damage, disease and possession with absolute clarity. This pinpoint accuracy enables the character to suggest treatment or to conduct psychic surgery.

## Psychic Surgery

**Range:** Touch

**Duration:** Varies with injury.

**Length of Trance:** 2D6 minutes of preparatory meditation, plus the duration of the surgery (which is half the time of conventional modern medicine).

**I.S.P.:** 14

Psychic surgery is used to repair broken bones, internal injuries, the removal of foreign objects (bullets, etc.), or when a character has suffered so much damage that he or she has lapsed into a coma (zero or less hit points). *The recovery from a coma* (near death) is equal to treatment from a hospital, 1-66%, when psychic surgery is used. Note that there is absolutely no scarring from psychic surgery and minimal pain (no pain if the deaden pain psi-ability is used). No tools are needed, only the psychic's hands. **Note:** A psychic diagnosis *must* be made before surgery is possible.

## Psychic Purification

**Range:** Touch

**Duration:** Immediate

**Length of Trance:** 6D6 minutes of meditation.

**I.S.P.:** 8

**Savings Throw:** None; except for the nega-psychic, standard.

The healer can use his abilities to slow a person's metabolism and destroy chemicals, drugs, poisons, and toxins in the body.



The effects of the drugs/impurities are immediately halted at the beginning of the meditation, and completely destroyed/negated by its end. Damage sustained prior to the psychic's intervention still exists.

## Resist Fatigue

**Range:** Self

**Duration:** One hour plus 20 minutes per level of experience.

**Length of Trance:** 1D6 melees of preparatory meditation.

**I.S.P.:** 4

A mind over matter discipline which enables the character to engage in physical activity without suffering from exhaustion. Although fatigue is temporarily suspended, the psychic will feel extremely tired and may even collapse when the psi-power's time limit lapses.

## Suggestion (Hypnosis)

**Range:** 10ft (3.0m), with eye contact.

**Duration:** Varies; rarely more than an hour or two.

**Length of Trance:** One melee (15 seconds) of preparatory meditation.

**I.S.P.:** 4 per idea, or attempt to implant an idea.

**Savings Throw:** Standard.

This ability is identical to the psychic sensitive.

# PHYSICAL PSYCHIC ABILITIES

## Alter Aura

**Range:** Self

**Duration:** One hour per each level of experience.

**I.S.P.:** 2

**Savings Throw:** None

A truly unique power that many psychic investigators claim is impossible and does not exist. Only a handful of physical psychics can manipulate their physical energy in such a way that it changes their aura. The altered aura will send the wrong message to those who can see auras. Alterations include:

- General level of experience can be made to seem much lower (level 1 or 2) or much higher (2D4 levels higher) than it really is.
- Conceal the presence of psychic powers.
- Conceal level of base P.P.E. (made to seem much lower).
- Conceal the presence of magic.

## Bio-Manipulation (the evil eye)

**Range:** 160ft/48.8m

**Duration:** 4-16 minutes (roll 4D4)

**I.S.P.:** 10

**Savings Throw:** Standard

The psychic is able to induce physical trauma to the nervous system of others by sheer force of will and psychic energy. This psi-power is often known as "the evil eye."

There are seven types of bio-manipulation effects. Each affects only one person per attack and can be used in any combination. Intended victims must be within line of vision or their exact

location known to the psychic. Each costs 10 I.S.P. to inflict.

This psychic power enables the psychic to temporarily manipulate specific biological functions or conditions in human and animal life-forms. *The duration can be extended 4-16 (4D4) minutes per additional 6 I.S.P.*

**Blind:** Temporarily knocks out the victim's optic nerves, rendering that person quite helpless. Victims are -9 to strike, parry and dodge.

**Deafness:** Can be caused by manipulating the eardrum. Victims can not hear anything, and are -6 to parry or dodge attacks from behind. In addition, the shock of suddenly becoming deaf makes them -3 to strike, parry or dodge any other attacks, and they automatically lose the initiative on all attacks.

**Mute:** Impairs the victim's vocal cords, making speech impossible. Victims are likely to be shocked and panic, making them -2 to strike, parry and dodge for the first melee ONLY.

**Pain:** By manipulating the nerve centers the psionic can induce terrible pain, shooting throughout the body. Victims are -6 to strike, parry, and dodge, and take one point of damage off their hit points (not S.D.C.) per each minute affected.

**Paralysis:** Immobilizes the motor part of the brain, causing legs and arms to stop functioning. Victims are completely incapacitated for the duration.

**Stun:** This attack disorients and confuses its victims. Victims forfeit one attack per melee, speed is cut by half, and are -4 to strike, parry and dodge.

**Tissue Manipulation:** Affects the tissue's connecting nerve fibers which can cause a variety of effects. By irritating the nerve fibers a victim will suddenly feel itchy, as if suddenly breaking out in a severe rash. Through endothermic manipulation the victim can be made to suddenly feel cold or hot while everyone around him feels fine. This is done by manipulating the body chemical which absorbs heat. ALL three conditions are more annoying or frightening than physically impairing. In each case the victims are -1 to strike, parry and dodge.

**Savings Throw:** Standard; if a character successfully saves against the attack he is not affected at all. This applies to all seven bio-manipulative attacks.

## Death Trance

**Range:** Self

**Duration:** As long as the psychic senses he must feign death, up to a maximum of four days.

**I.S.P.:** 1, (It's easier for the physical psychic to control his body, because that's the focus of his powers).

A state of mind over matter that slows the metabolism to such a degree that it creates a temporary state of suspended animation, simulating death. Without hospital facilities, even a medical doctor is likely to believe the character is dead (1-89% likelihood). The effects of drugs, toxins and chemicals are slowed to a crawl, doing ¼ damage or effect, but will take full effect the instant the death trance is stopped (unless treatment is administered first). While in the death-like state, the psychic can not be roused or respond to any type of stimulation, including psychic probes. This means he is incapable of attacking or defending himself in any way until the trance is broken.



## Ectoplasm

**Range:** 40ft + 5ft per level of experience (12.2 + 1.5m).

**Duration:** 4 minutes (16 melees) per level of experience.

**I.S.P.:** Vapor — 6 I.S.P., Solid — 12 I.S.P.

This mystifying ability enables the psychic to create a slightly luminous, vapor-like substance that is extruded from the pores. Ectoplasm has two forms: an invisible vapor and a luminous, solid state.

The **vapor** is a sort of floating, probing finger that can snuff out candles, open doors, knock over or pick up small objects (weighing under 9 ounces/255 grams), tap somebody on the shoulder, rustle leaves and knock on a door. The ectoplasmic vapor can be seen only by its creator, psychics and supernatural beings who can *see the invisible*, or with *infrared optic systems* (including i.r. camera lenses, i.r. gun sights, etc.). Ectoplasm, although an invisible vapor, has *physical properties*, which means it can not go through walls or other solid obstructions. Thus, a person walking into an ectoplasm stream may feel a slight sensation, like walking into a spider's web or brushing against a cotton ball. Often a person will unwittingly walk into and snag the stream of floating ectoplasm, pulling or stretching it along without being aware of it. In such cases, the psychic must maneuver the snagged portion to loop around the human obstruction. The creator of the vapor can control the full length of the vaporous stream like a floating tentacle. Although the vapor can not go through solid objects it can slip through keyholes, cracks under doors or loose seals around a window. If a breeze can blow through, so can ectoplasm. The only drawback is that the character must be able to see the ectoplasm to maneuver it.



The solid state of ectoplasm can be a startling sight, for it is clearly visible to everyone. In this form the ectoplasm can be shaped into an extra limb, such as a hand or arm and hand, or tentacle or even a foot. The ectoplasmic limb appears as a white, slightly luminous appendage connected to a trail of ectoplasm stretching back to its creator like a life-line of silly putty. The appendage and its connecting line can hover, float, levitate and fly (at a speed of 18). The solid ectoplasmic limb has much greater strength; able to carry, lift or hold up to 40lbs/18kg, but can not squeeze through the tiny openings that the vapor can. An opening must be at least the size of a quarter for solid

ectoplasm to fit, and then the limb must be turned into a thin tentacle and reformed on the other side of the opening. Ectoplasm can also be used to create a face or even a full figure, although detailed features are impossible. Ectoplasmically created images may explain apparitions reported during some seances.

**Ecto-Combat:** The ectoplasm vapor and solid form both have an *automatic dodge* against all attacks directed at any of its length. That means an attempt to hack the middle of the ectoplasmic stream/connecting line will see that portion of the ectoplasm suddenly swerve, loop or bend with a life of its own to avoid the attack. The dodge at the midsection (or anywhere else) does not count as an attack/action by the appendage at the other end. The appendage also gets an automatic dodge in addition to its attacks/actions per melee. A vapor or solid appendage *must* be controlled by its creator at all times (except the automatic dodge); thus, it has a number of attacks/actions equal to its creator's. So, if the psychic has four attacks per melee, the ectoplasm appendage also has four attacks. However, each attack/action by the ectoplasm counts as one of the character's attacks/actions that melee.

The solid ectoplasm appendage is not a great tool for combat. It limits the person's attacks/actions per melee and has minimal strength; equal to about a P.S. attribute of 4. A punch or kick does a mere one point of damage. Damage can be increased by the appendage using any type of hand-held weapon under 40lbs and less than five feet (1.5m) in length. Small modern weapons, such as a pistol or revolver, can be used, but are *minus -10 to strike*. The *vapor* can not use any weapons weighing more than 9 ounces and can inflict no damage of its own.

### Ecto-Combat Statistics

- Vapor and solid get an *automatic* dodge against all attacks, including multiple or simultaneous attacks.
- +5 to dodge; applies to vapor and solid.
- +1 to parry; applies to vapor and solid.
- +1 to strike; applies to vapor and solid.
- Astral S.D.C. is 40 plus one hit point. Applies to vapor and solid. If the ectoplasm is destroyed the creator takes one hit point and 10 S.D.C. of physical damage.
- Vapor inflicts no physical damage, but can touch, tap or pickup and carry objects weighing 9 ounces or less.
- Solid ectoplasm inflicts one point of damage in combat or by weapon.
- Attacks or actions per melee are equal to its creator's. Each attack/action by the ectoplasm, excluding dodges, counts as one of the character's attacks that melee. A pair of ectoplasmic limbs will divide the attack between the two equally.
- Sunlight or bright artificial light (250 watts) reduces the range to half.
- Maximum range possible for vapor and solid is 40ft plus 5ft per level of experience (12.2 + 1.5 meters per level).
- One full melee (15 seconds) is required to create an ectoplasm vapor or solid appendage.
- Half a melee (7 seconds) is needed to withdraw/return ectoplasm into its creator.



## Electrokinesis

**Range:** Varies

**Duration:** Varies

**I.S.P.:** Varies

Electrokinesis is a psychic power that allows the psychic to exert amazing physical control over electricity.

- 1. Electrical Resistance:** The psychic can manipulate his body so to become resistant to electricity. Up to 60,000 volts will inflict no damage or ill effect. Currents greater than 60,000 volts, including lightning and magic electricity, do half damage. **Range:** self. **Duration:** 3 minutes per level of experience. **I.S.P.:** 4.
- 2. Electrical Discharge:** The character can cause *static* electricity within a six foot (1.8m) area, as well as emit an electrical discharge by touch. *The discharge* can be a little jolt or inflict up to 1D6 damage as often as once per melee. **Range:** touch or 2ft distance. **Duration:** Instant. **I.S.P.:** 2 per each discharge.
- 3. Manipulate Electrical Devices:** Through focused thought the psychic can enforce a limited control over electrical devices, such as turn off and on light switches, computers, televisions, radios, blenders, microwave ovens, flashlights, toys (battery and plug types), windshield wipers, and all types of electrically operated appliances, toys and devices. He can also manipulate the controls of the device, such as volume, channel selection, tuners, speakers, change speed, dim lights, and so on. A dozen different electrical functions can be manipulated each melee. This can mean flicking the light off and on six times (12 functions/6 off, 6 on) or turn on the T.V., turn its volume up to the max. and turn on 10 other appliances (12 functions in all). **Range:** 45ft + 5ft per level of experience (13.7+1.5m per level). **Duration:** 2 minutes per level of experience. **I.S.P.:** 4. **Note:** The character does not need to see the devices to manipulate them. He can feel their presence.
- 4. Sense Electricity:** The psychic can sense or feel electricity and pinpoint its exact location with fair expertise. **Range:** 45ft + 5ft per level of experience. **Duration:** 2 minutes of extreme sensitivity when he can pinpoint every source of electricity in the area. **I.S.P.:** 2 per every two minutes. **Base Skill:** 55% + 5% per each additional level of experience. A *failed roll* means only 1D6 × 10% of all the electrical devices/sources of electricity could be sensed.

## Hydrokinesis

**Range:** Varies

**Duration:** Varies

**I.S.P.:** Varies

This ability enables the character to use psychic energy to sense and influence water.

- 1. Sense Chemical Impurities:** The psychic can sense whether or not water is polluted/contains other substances. The exact nature of the additive or pollutant may be unknown, but he will know that it is not completely natural. *When sensing water, first roll to determine:* **1) Pure or Drinkable** (nonhazardous/tap water) 70% + 5% per each additional level of experience. **2) Second, Roll for general nature of the pollutant;** this identifies whether it is chemical/drug (not deadly, but will cause a reaction if drunk) or poison/toxin

(deadly or harmful if swallowed). Success ratio in identifying the general nature of the pollutant is 35% + 5% per each additional level of experience. **Range:** self/six inches. **Duration:** One minute (4 melees). **I.S.P.:** 2 per minute.

- 2. Boil Water:** The psychic can increase the temperature of water raising it to boiling level within one minute (four melees). Up to one gallon (3.8 liters) can be affected. Once set a boiling, it will take the usual amount of time to cool. This power can *not* be made to boil the water or blood in a living creature. **Range:** 8ft (2.4m) + 2ft (.6m) per level of experience. **Duration:** One minute (4 melees). **I.S.P.:** 3 per gallon of water.
- 3. Water Spout:** An ability that enables the psychic to control and hurl water. The effect can be used to make water bubble (but not heated), shoot straight up like a geyser or a water blast hurling across a room like a short, powerful spray from a garden hose. Up to one gallon of water can be manipulated and hurled up to a distance of 20 feet. **Note:** The fluid must be 75% water to be controlled, such as punch, hot coffee, chicken soup, tea, kool-aid, etc. Forget about hurling ice (frozen does not count), paint, gasoline or cake batter.

Making water leap with a life of its own can be startling to others and can make a great distraction if handled right. Hurling normal water or a cool drink into somebody's face/eyes will momentarily blind and surprise the individual, causing him/her to lose initiative and one attack that melee. Hurling hot or boiling water on the body (especially the crotch) will have the same results. Hurling *boiling water* in the face is horribly painful, causing 2D4 damage, loss of initiative, loss of all attacks for 1D6 melees and temporary blindness for 3D6 melees (– 10 to strike, parry and dodge). Characters of a good alignment will not hurl boiling water in the face unless under an absolutely life and death circumstance.

**Hurling range:** 20ft/6.1m. **Duration:** Instant. **I.S.P.:** 5. **Bonus:** + 1 to strike. Making water bubble or rise up like a fountain can be maintained for up to 30 seconds (2 melees). **Note:** The psychic can influence up to one gallon of water up to 20ft away, whether he can see it or only feel its presence.

- 4. Sense Water:** The character can sense the presence of any water exposed to the open air automatically at no cost of I.S.P. **Range:** 20ft/6.1m. **Duration:** Permanent. **I.S.P.:** None. **Note:** Underground rivers, airtight containers, etc., can *not* be sensed.

## Impervious to Cold

**Range:** Self

**Duration:** 20 minutes per level of experience.

**I.S.P.:** 2

A mind over matter discipline which enables the character to suffer absolutely no ill effects or discomfort from exposure to even extreme freezing conditions.

## Impervious to Fire/Heat

**Range:** Self

**Duration:** 3 minutes per level of experience.

**I.S.P.:** 4

Another mind over matter discipline enabling the psychic to endure intense heat, fire, boiling water, hot coals, and so on without suffering pain, damage or scarring. Magic fires inflict



half damage.

## Impervious to Poison/Toxin

**Range:** Self

**Duration:** 2 minutes (8 melees)

**I.S.P.:** 4

The character can negate the full effects of poisons and toxic chemicals which he has ingested (eaten or drank) or introduced into the bloodstream, as long as he/she has advance knowledge of its deadly properties. A poison, toxin, or drug which has been unknowingly inflicted (and starting to take effect) can be negated too, but will do *half damage* or effect before it can be completely negated. **Bonuses:** Identify poisons — 30% + 4% per level of experience; +2 to save vs poisons and drugs.

## Levitation

**Range:** Up to 60ft/18.3m away.

**Duration:** 2 minutes per level of experience.

**I.S.P.:** Small — 2, medium — 6, large — 6 per every 10 pounds of weight.

**Savings Throw:** None

Levitation is a limited form of telekinesis that can raise an object (or even a person) straight up into the air and suspend it there (hover). Small objects weighing two pounds (0.9kg) or less are the easiest to levitate. Maximum height is 8ft (2.4m) plus one foot (0.3m) per each level of experience. Medium size objects weighing 3 to 20 pounds (1.4 to 9.1kg) are more difficult, requiring greater concentration. Maximum height is 6ft (1.8m) plus one foot (0.3m) per level of experience. Large objects or people weighing over 20lbs cost 6 I.S.P. plus 1 I.S.P. for every 10lbs beyond 20. Thus, a 125lb weight (56.7kg) would require 17 I.S.P. to raise it into the air. Maximum height is 4ft (1.2m) plus one foot (0.3m) per level of experience.

## Meditation

**Range:** Self

**Duration:** Varies with the person's needs.

**I.S.P.:** None

Meditation is the only ability that can be done at any time and costs no I.S.P. to perform. Meditation is not so much a psychic power as it is a mental discipline. The character meditates by dwelling upon a single notion, mental object, or mantra (a repetitious chant or humming), to achieve a deep relaxation, focus, or to gain insight and harmony into one's inner self, nature and the universe. Meditation is often required to use psychic and magic powers.

## Mind Block

**Range:** Self

**Duration:** 10 minutes per level of experience.

**I.S.P.:** 4 (per each duration period)

This is the ability to completely close or block oneself from all psychic/mental emanations. When intentionally closed to supernatural or psychic forces the character can not sense anything, can not use psychic abilities, nor be influenced by others. A mind block will prevent penetration of telepathy, empathy, hypnotic suggestion, and empathic transfer. It can be an invaluable protective mask when dealing with malevolent psychic forces. Adds a bonus of +1 to save vs all psychic and mental attacks.

## Pyrokinesis

**Range:** Varies

**Duration:** Varies

**I.S.P.:** Varies

Pyrokinesis is a psychic power that gives a character the power to manipulate fire.

- 1. Fire Resistant:** The psychic can endure great heat and fire with minimal ill effect. **Damage** is reduced by half. Magic fires do full damage. **Range:** Self. **Duration:** 5 minutes per level of experience. **I.S.P.:** 2.
- 2. Spontaneous Combustion:** The ability to create a spark that will ignite combustible material, such as paper, old rags, dry grass, gasoline, etc. Note: Human hair should not be considered a combustible material. This is a slow fire, starting with a tiny spark and grows. Initially, it is not a roaring blaze. **Range:** Can be ignited up to 30ft away (9.1m). **Duration:** Instant; fire will last and spread until it is put out or there is nothing to burn. **I.S.P.:** 2.
- 3. Fuel Flame:** The character can feed the fire with psychic energy, doubling it in size. **Affects** a 10ft (3m) area. **Range:** Up to 30ft + 5ft for each additional level of experience. **Duration:** Instant. **I.S.P.:** 4.
- 4. Extinguish Flames:** The power to instantly put out an area of fire. **Affects** a 15ft (1.5m) area of fire. **Range:** Up to 30ft + 5ft per each additional level of experience. **Duration:** Permanent until set on fire again. **I.S.P.:** 4.
- 5. Create Flame:** The incredible ability to create fire out of thin air. Can be an 8ft pillar of fire affecting a 4ft (1.2m) area or a 6th wall of fire stretching six feet long (1.8m) plus one foot per each additional level of experience. **Damage:** 4D6 from the pillar, 6D6 from the wall, plus both have a 72% likelihood of setting any combustibles it they touch ablaze (including cloth, rugs, curtains furniture, etc.). **Range:** Cast up to 30ft + 2ft per additional level of experience. **Duration:** 2 minutes per level of experience; longer if it sets other things on fire. **I.S.P.:** 20.  
Another fire creation ability is the hurling of a *fire ball*. **Damage:** 6D6, **Range:** 30ft + 2ft per each additional level of experience. **Duration:** Instant. **Bonus:** +2 to strike. **I.S.P.:** 25.
- 6. Sense Fire:** The psychic can sense or feel the presence of fire and pinpoint its exact location. **Range:** 100ft + 5ft per level of experience. **Duration:** 2 minutes of extreme sensitivity when he/she can pinpoint the exact location of every fire in the area. **Base Skill:** 90% success ratio. A *failed roll* means only 2D4 × 10% of the fires can be located by sensing. **I.S.P.:** 2 per every 2 minutes.

## Resist Fatigue

**Range:** Self

**Duration:** 1 hour + 20 minutes per level of experience.

**I.S.P.:** 4

A mind over matter discipline which enables the character to engage in physical activity without suffering from exhaustion. Although fatigue is temporarily suspended, the psychic will feel extremely tired and may even collapse when the psi-power's time limit lapses.



## Resist Hunger

**Range:** Self

**Duration:** 6 hours

**I.S.P.:** 2

Another mind over matter discipline that subdues any feeling of hunger, allowing the character to function at full effectiveness without nourishment. It is important to point out that while the psi-power maintains full operations, the body is still suffering from malnutrition and starvation. Loses 3lbs of weight per day. **Note:** A psychic can survive up to 60 days, functioning as normal, without any food by continually using resist hunger. On day 61 the character will lapse into a coma. Under this extreme condition, 60 days of food deprivation while still fully active physically, the character is -20% to save vs coma/death.

## Resist Thirst

**Range:** Self

**Duration:** 6 hours

**I.S.P.:** 6

This ability is identical to the resist hunger psi-power except it applies to the consumption of water. It does not negate the long-range damage from dehydration.

## Speed Reading

**Range:** Self

**Duration:** 3 minutes per level of experience.

**I.S.P.:** 2

This is the ability to read and comprehend the written word extremely quickly. Speed of reading is 30 pages per minute/4 melees. The psychic will retain the information as he would normally. Highly technical texts will reduce the speed reading by half (15 pages per minute) and may require two readings.

## Summon Inner Strength

**Range:** Self

**Duration:** 10 minutes per level of experience.

**I.S.P.:** 4

This psi-power enables the character to draw on his inner reserves of strength to ward off pain and fatigue. Every time the psychic calls upon his inner strength the following bonuses apply:

- Add +10 S.D.C.
- Add +2 to save vs poison or toxins.
- Add +5% to save vs coma/death.
- Fatigue is temporarily forgotten and the character can function as if he was fully rested for the full duration of the summon inner strength power.

## Total Recall

**Range:** Self

**Duration:** Permanent

**I.S.P.:** 2

The character remembers every word he reads. Specific blocks of information can be recalled in perfect detail at will. Each block of information costs 3 I.S.P. to recall in absolute detail. If all I.S.P. have been expended, the memory is a little

fuzzy so that exact quotes and details may be impossible to recall. *Roll percentile:* 1-50 remembered in full detail, word for word; 51-80 details are forgotten, but the full essence of the ideas are clear; 81-00 can only recall the most basic concepts no details nor strong comprehension.

## Telekinesis

**Range:** Up to 60ft (18.3m) away.

**Duration:** 2 minutes per level of experience.

**I.S.P.:** Small — 3, medium — 8, large (over 20lbs) — 8 + 1 per every 10lbs of weight.

Telekinesis is the ability to move objects without any other means than directed psychic energy. The character can make an object hop, fall, roll, rise into the air, suspend it there (hover) or make it fly across the room.

In order to move an object by telekinesis, the item must be clearly visible, within the psychic's range (60ft/18.3m) and the point of focus. As usual, the psychic must concentrate on what he is doing; thus, each telekinetic feat counts as one of the character's physical attacks. The total number of telekinetic attacks is equal to the character's number of physical attacks per melee; usually 3 or 4. One can attack with telekinesis by hurling an object as if thrown or causing it to buzz about a room, swinging and hitting like a club controlled by an invisible hand. Several objects can be telekinetically thrown around within the same melee round, but not simultaneously. The psychic can only concentrate on one item at a time. **For Example:** A physical psychic with four, normal, hand to hand attacks per melee can perform four attacks with telekinesis. First, he makes a flower vase fly from the table, aiming it at his opponent's head. Second, he makes the lamp hurl at the guard at the door. Third, the table is suddenly flipped up on end and, fourth, the doorknob is turned and the door flung open. Four attacks or actions using telekinesis.

As we can see in the example, telekinesis can be used to do more than making objects fly around. The telekinetic power can be used to open doors, flick switches, press buttons, turn knobs and dials, open windows, make a rocking chair rock and so on. The range of possibilities is extensive when you stop and think about it. Remember, each action counts as one of the character's physical actions/attacks per melee.

It is easiest to move or hurl small objects weighing two pounds (0.9kg or less). Maximum height or distance is 60ft (18.3m). Medium size objects weighing 3 to 20 pounds (1.4 to 9.1kg) are more difficult to manipulate. Maximum height or distance is reduced by half — 30 feet (9.1m). Large or heavy objects weighing over 20lbs are the most difficult to maneuver, reducing maximum height and distance to 15ft (4.6m). I.S.P. cost for large, heavy objects is 8 I.S.P. for the first 20lbs (9.1kg) plus one I.S.P. for each additional 10lbs (4.5kg) of weight. This means it would cost 19 I.S.P. to move a 125lb (56.7kg) weight (8 I.S.P. for the first 20lbs + 11 I.S.P. for the remaining 105lbs). Remember, the height and distance of effect is limited to 15ft (4.6m) for such a heavy item.

### Combat Bonuses:

- +3 to strike with telekinesis; physical/skill bonuses to strike do not apply when telekinesis is used.
- +4 to parry with telekinesis, by using a controlled object to parry or sheer telekinetic force to block an attack. Counts as a medium, heavy object; costs 8 I.S.P.





● **Damage from Hurling Objects:**

Small: 6 ounces to 1 pound — 1D4

Small: 1½ to 2lbs — 1D6

Medium: 3 to 4lbs — 2D4

Medium: 5 to 10lbs — 3D4

Medium: 10 to 24lbs — 3D6

Large: 26 to 40lbs — 4D6

Add 1D6 for each additional 20lbs of weight.

**Note:** Telekinesis is not a force field, thus, while it can be used to parry/block a punch, kick, club, knife or even sword, it can not stop bullets, arrows, gas, flying tackles, and similar attacks. Furthermore, a failed roll to telekinetically parry means the psychic did *not* parry and *is* struck by his opponent.

## PSYCHIC SENSITIVE ABILITIES

### Astral Projection

**Range:** Self

**Duration:** 5 minutes per level of experience.

**I.S.P.:** 8

Through intense concentration/meditation (4D4 minutes of preparation) the psychic can free his mind, or inner self, from his physical body. This psychic inner self is the astral body, a whitish, transparent, ghostly image of the character's physical form. A long silver thread or *cord* connects the astral body with its physical self. If the cord is severed the character is likely to die of sudden shock as body and soul are torn asunder. There is only a 30% chance the astral self can locate its physical body without the silver umbilical cord (roll best 2 out of 3).

The physical body lapses into a coma-like trance when the astral self has left it. In this state the body is completely helpless. It can not walk, move or think; completely catatonic.

*The hazards are threefold:* **First**, if the physical body is killed, the astral body is forever lost and will die, fade away, within

six hours. **Second**, if the astral body gets lost or captured while in the astral plane, the body will begin to waste away and die. (**Note:** One minute of our time is equal to one week in the astral plane). **Third**, the astral body is vulnerable to psychic attacks and attacks from ghosts, entities and creatures of the astral plane.

There are two levels of astral projection, *coexistence* (physical body and spirit form) in the material world and/or *the astral plane* (another dimension). Astral projection from the physical body into the *material world* creates a ghostly spectre of the astral self which can be seen only by other psychics, young children under 13 years old, animals and most supernatural creatures. While in astral form the character automatically gains the ability to float, fly (mach one/670mph maximum), see the invisible, pass through solid objects, impervious to physical harm (including cold, heat and energy), and see and hear as usual. The astral body can not communicate with the physical world except through telepathy or empathy, nor speak to, smell or touch anything on the material plane. The astral self is little more than a mute, ghostly observer. Of course, this is a great way to locate invisible supernatural entities, as well as spy on other humans on the material plane (although limited by short sprints. See duration).

**Traveling in astral form** has its own very special dangers. While the character can see the invisible and other astral travelers, they can also see him. This makes him susceptible to their psychic and astral form attacks, for two astral travelers can lock into hand to hand combat as well. The most vulnerable target is the silver cord which is the astral traveler's lifeline to the physical world. Fortunately, the cord has an *Astral S.D.C.* which is two times that of the person's physical hit points and S.D.C. combined. The thread-like silver cord is a difficult target to hit; attackers are -6 to strike. The astral body also has an S.D.C. two times greater than the hit points and S.D.C. of the physical body combined. This means if the character has 18 hit points and 28 S.D.C. both the astral body and its silver cord have 92 Astral S.D.C. each (18 + 28 = 46 × 2 = 92 each). Remember, magic and psychic influence have full effect on the astral body. This includes exorcism, which will force the astral traveler to leave the immediate area (400ft radius) and not return



for 24 hours. The astral traveler has the same number of attacks per melee, bonuses, hand to hand, skills, knowledge and psychic powers that he or she has in the material plane.

**Entering the astral plane** is like entering the twilight zone. After a minute of concentration the astral gateway appears as a bright patch of shimmering, white light. Once the astral traveler passes through it, he will find himself in an endless expanse of white light, and rolling, white clouds. There is no up or down, no bottom or top; no north or south, no land or air or sea, just endless, slowly swirling white. Time too, is a different or altered state, for what would seem to be a week in the astral plane is barely one minute in the physical world. Time and space twisted and distorted, the astral traveler can travel from one end of our planet to the other, in the blink of an eye, by hopping through the astral plane. While this may sound wonderful, the astral plane has its dangers as well. **First**, the distortion of place and time makes it extremely difficult to find the material world and one's dormant, physical body. Even trying to follow the silver cord can lead to nowhere.

**To return from the astral plane to the physical body, roll on the following table:** Each roll will determine the astral traveler's state of mind and sense of direction. The percentile dice can be rolled up to three times per melee (15 seconds). The player must roll "definitely certain" to successfully return. The player may keep trying until he succeeds or time elapses.

#### **Location of the Physical Body**

##### *Roll Percentile Dice to Return from the Astral Plane*

- 1-30 Hopelessly Lost (roll again).
- 31-50 Uncertain, Confused (roll again).
- 51-76 Fairly certain of location; on the right track (roll again).
- 77-00 Definitely certain of location. (Whew! Made it Back).

\*Astral travel with a *partner* is a much safer way to travel, because if one can find his body, he can lead the other one out with him.

**Note:** Traveling on the material plane in astral form is infinitely easier than the astral plane. To find the physical body the character need only return to where he left it. If it has been moved or hidden the astral self can sense its location with a 60% efficiency (roll once per melee).

**The other danger** lies in being attacked by other beings in the astral plane. Entities and elemental creatures of magic live in the astral plane or travel through it. These beings are usually hostile, evil forces. While the astral body can not touch or communicate with the material world, the astral body is quite solid to other inhabitants of the astral plane. The astral body is also vulnerable to magic and psychic powers, as well as physical assault by astral entities.

The energy which composes the astral plane is responsive to thoughts and desires. The strongest astral beings can mentally or magically control what a small area might look like. This means that the astral plane is made up of hundreds or perhaps thousands or even millions of tiny astral "kingdoms" adrift within the vast whiteness. Exactly what these kingdoms look like is up to the entity that creates it. Some may look like a modern city, other castles or forests, while still others, a frightening landscape. Perhaps this is where legends of visitations to heaven and hell originate? It is always wise to avoid an astral kingdom, because only the most powerful entities and astral beings can create and maintain them. In Professor Victor Lazlo's book, "Worlds

Within Worlds," he provides us with this firsthand account of astral travel:

*"Although I myself have only minuscule psychic abilities, what might be considered a latent psychic (very latent), I had never been able to achieve astral projection. However, lord, high priest Vish-taal assured me that he could help me achieve the reputed state and lead me into the astral plane. So I bravely began my excursion into the ethereal realm that coexists with our own. After nine days of fasting, consuming only herb broth prepared by Vish-taal once per day, I was ready at last. We meditated together for three hours then, before I realized it, I was looking down at my own body. The sensation must be akin to floating in the weightlessness of space. The room seemed somewhat out of scale and distorted, like looking through a fish-eye lens. Suddenly I realized Vish-taal was floating next to me. He assured me that all was well and that after a few more out of body experiences I could see the material world as clear as normal. But today our goal was the astral plane. He took hold of my shoulder and beckoned me to come. With that, we both rose upward through the ceilings of the next three floors, the roof and skyward. I must confess that my 23 years as an investigator of the paranormal had not prepared me for this experience. All my professional cool had fled me the moment I left my body. I was so enthralled with the events and images that without the guidance of Vish-taal I would have bobbed about the room like a dumfounded child seeing Disneyland for the first time. Everything seemed to sweep by me, stealing my full attention for that moment, giving away to the next sensation and the next. As one sped skyward at a speed I can not begin to guess, the sparkling body of my astral guide caught my attention. For the first time, I noticed that our astral bodies were aglow with a bright translucent, blue-white light with countless tiny flashes of white, yellow, and blue light, like a thousand microscopic strobe lights set for a slow pulse. A thread of translucent silver unreeled itself as we rocketed ahead. Vish-taal yanked my attention with the words 'the gateway'. Before us was a glittering wall of light which we plunged through at great speed without pause. Suddenly we were plunged into a world of swirling white, broken only by wisps of white clouds. There was no longer any sense of up or down. Direction had no meaning. Without my astral guide to calm me I would have become lost in the vastness of the white infinity. Vish-taal assured me that with training one could sense the material world and use it like an invisible compass. I must admit that after what seemed to be about a half hour, I was able to discern shapes and patterns in the endless white clouds and mists. A strange calm seemed to take hold of me and made the whiteness seem far less alien. Then, after a long while, appearing through a fog-like mist stood a forest. Shades of green and brown and grey leaped out of the whiteness. A blue sky broken by cumulus clouds radiated around the green. Without realizing it, I had automatically gravitated toward the oasis of color. Suddenly, the sensation of evil shot through me like a hundred burning needles. Never in my experience as a minor psychic sensitive had I ever felt such hatred, such loathing. To my left a billow of grey*



and black storm clouds began to roll out from the green trees. The blue sky darkened and the clouds shot toward me with an anger I can not describe. Vish-taal's voice echoed in my ears: 'Go now we must, Victor. We should not try battle with this one. Now Victor, away from the dark. Flee with me and look not back.' We sped through the white and I did not look back. Obviously, I survived to tell this tale. When we returned to our physical bodies I was still shaking. Vish-taal smiled knowingly and said, 'Victor, you see much adventure this day. I will send food while you much relax.' With a wink, the old yogi left me with my own thoughts.

"The experience seemed to last several hours. I would have hazard to guess eight or nine. Yet the wall clock confirmed with my wristwatch that less than six minutes had actually elapsed. Did I experience astral travel? Or was it sensory deprivation? The wily old priest could have easily drugged my broth or even hypnotized me. I had seen him expertly use hypnosis on others on countless occasions. But the old man and I had been friends for years and I honestly don't think my mentor would deceive me. So this then was the astral plane. I wish I could relate the details with greater clarity, but as I said, my objectivity and skills as an investigative reporter deserted me. One thing that did strike me was how much my astral plane experience seemed to mimic the transmissions of Lt. Taylor from Flight 19, which disappeared in 1945 over the Bermuda Triangle. In that celebrated and much disputed case, five Air Force Avenger Torpedo Bombers disappeared during a routine flight near Ft. Lauderdale, Florida. The leader's (Lt. Taylor), radio transmissions were bizarre. He reported that both compasses were out, and on a fairly clear winter afternoon, could not find Ft. Lauderdale. Other transmissions speak of vast whiteness and swirling clouds. Of not being able to find the sun or ascertain any sense of direction. Not even up or down. The transmissions faded in and out until they stopped. The final transmission: "We'll fly west until we hit the beach or run out of gas." Flight 19 disappeared without a trace. The most logical explanation is that the five aircraft perished in a sudden squall; not that any storms were known to have arisen that afternoon. Is it possible that some mysterious force opened a portal into the astral plane? A portal that the five bombers, and a sixth search aircraft and its crew of thirteen, inadvertently flew into? It is a possibility I must investigate further."

Excerpted from Victor Lazlo's *WORLDS WITHIN WORLDS*, 1977.

## Clairvoyance

**Range:** Self (although the image could pertain to people or places thousands of miles away).

**Duration:** 6D6 Melees

**I.S.P.:** 4

**Base Skill:** 58% + 2% per level of experience.

This allows the psychic to see or feel glimpses of the possible future. This is achieved through meditation or intense concentration in which the clairvoyant thinks about a particular person, event or place. Add +5% to the base skill if the person involved

is a friend or loved one. Clairvoyance is unpredictable and can not be turned on and off like a light bulb. Sometimes it works (if the roll is under the base skill) and sometimes it does not (when the roll is above the base skill). A failed roll means the psychic received no insight to the future.

A clairvoyant trance can be attempted as often as *twice every day*. The message can be a sudden feeling that somebody is in need ("... something's wrong. It's ... it's ... Janet! I've got to see her!") or, more often, a sudden flash of insight, a sudden image that races through the mind. The image is like a brief snippet of film from a movie or a dream. Often all the details are not clear, but the potential danger is. For example, "The psychic character is in a trance or meditation, thinking about his/her friend Janet. Suddenly, the mind is flooded with an image of Janet rushing down a crowded street. It's dusky, like morning, twilight or evening. She seems very upset. The traffic light changes to amber. Janet races into the street, ignoring the light. It turns red. There's a car, squeal of tires, Janet screams. The image ends. Is Janet hurt? Killed? Unknown, but the danger is clear. There are also other hints of information: the time of day, Janet seeming upset, rushing, etc. The glimpse into the future could be twenty minutes, eight hours, 24 hours, or a week. The psychic has no way of knowing. Of course, he has the advantage of recognizing the potential danger as it begins to unfold and may be able to avoid it, stop it or change the outcome. The image may last a few minutes or be a sudden flash lasting but a few seconds. The flash could be a peculiar noise, a face, or a specific image, like a particular door or object.

It is important to note that sometimes a clairvoyant image will occur unintentionally, without the psychic trying to do so. These most often manifest themselves as dreams or nightmares during sleep. The clairvoyant dream is exactly like the image from a meditative trance described previously. The precognitive flash of the future may also occur unbeckoned while awake, but this is extremely rare. These brief glimpses of the possible future happen because the clairvoyant is acutely attuned to his world. Anything that might hurt or change that world (including people and places) will often be foretold in a flash of insight.

**Game Masters:** Be careful of revealing too much. Use the examples provided as a guide. Remember, these are brief glimpses of the possible future, not a motion picture. The psychic can NOT engage in any actions, combat or otherwise, during a moment of clairvoyance or the image will instantly stop. It usually requires 2D4 melees of concentration or meditation before the image occurs. Remember, a failed base skill roll means absolutely nothing happens, but still burns up the 4 I.S.P. and time.

## Death Trance

**Range:** Self

**Duration:** As long as the psychic senses he must feign death, up to a maximum of four days.

**I.S.P.:** 2

A state of mind over matter that slows the metabolism to such a degree that it creates a temporary state of suspended animation, simulating death. Without hospital facilities, even a medical doctor is likely to believe the character is dead (1-89% likelihood). The effects of drugs, toxins and chemicals are slowed to a crawl, doing ¼ damage or effect, but will take full effect the instant the death trance is stopped (unless treatment is adminis-



tered first). While in the death-like state, the psychic can not be roused or respond to any type of stimulation, including psychic probes. This means he is incapable of attacking or defending himself in any way until the trance is broken.

## Divination

**Range:** Self

**Duration:** 2D4 minutes

**I.S.P.:** 3

**Base Skill:** 42% + 2% per each additional level of experience.

Divination is a *precognitive* ability to sense the future. Throughout the history of the world there have been fortune-tellers who claim to foretell the future by reading tarot cards, sticks, palms, tea leaves and other things. This precognitive power is much less accurate and detailed than clairvoyance. With divination there is no image, no sound, no tangible memory or flash, only an impression.

To perform a divination, the diviner must meditate for at least 15 or 20 minutes. The tools or item(s) read by the fortune-teller are laid out/spilled before the psychic, their random patterns providing *hints* to the future. No specific questions or details can be revealed, such as, "Yes, if you go to the house this evening you will be attacked by a madman and murdered with a knife." Instead, what *might* be revealed is something like, "I see the spectre of death. It waits hurgrily. I see violence and . . . yes . . . madness." or "Death awaits you at the house." Neither says that the character will be killed, but does confirm that somebody or something may be out to kill him. This is the way divination should work, small *impressions* of the *possible* future. **The game master** should never predetermine the outcome of a game or an event within a game. Like real life, there are too many x-factors which can change what may seem inevitable. Consequently, keep the divination answers a bit general to give yourself maximum flexibility of play. NEVER make a situation completely hopeless!

**The diviner** can try to divinate his own future, but with a -10% skill penalty, or the future of ONE person at a time. **The person can ask** up to 13 questions which the diviner will try to answer. The divining character must roll percentile dice for each question. **A failed roll** means he senses *nothing* and can not answer the question. Professional fortune-tellers will make up some intriguing line of malarkey like, "The wheels of the future are always turning. Too many things could influence your future in this regard (in answer to the question). Proceed with caution." or "Something blocks my vision . . . I can tell you nothing."

There are all types of methods and items of divination. The psychic's personal orientation/focus must be limited to one or two types. Select one (or two maximum) focuses/objects needed for divination. **Note:** That the character can not see into the future without using the item(s).

### DIVINATION FORMS TABLE

**ARITHMANCY:** The use of numbers, either in patterns which reoccur around the person or selected randomly, to tell their past or predict their future. See also Numerology.

**ASTRAGALOMANCY:** Divination by the use of dice or marked pieces of bone. This technique includes modern dice, the Viking system of "casting the runes" and the casting of human and animal knucklebones used by African witch doctors.

**BELOMANCY:** Foretelling the future by throwing arrows to the ground and observing the pattern they form. This particular technique would be well suited to primitive or modern, bow-using cultures.

**CARTOMANCY:** This form of divination is done literally by the "turn of a card." It uses special decks of cards, known as Tarot, but can also be done with a regular deck of playing cards. Each card is ascribed a specific meaning and are laid in a pattern. Meditation on the cards and the pattern they form give the divination. Cartomancy has always been one of the most popular kinds of fortune-telling and has existed from the time of the Pharaohs of Egypt.

**CEPHALOMANCY:** This divinatory skill uses the bumps and depressions which can be found on a person's skull to predict their future. It is vaguely related to palmistry in that the person's entire future is supposed to be written on their body.

**CHIROMANCY:** Also known as *palmistry*, this art teaches the user to read the future in the lines found in the palms of the questioner's hands. Each line is supposed to govern one particular area of life, including Life, Love and Fortune.

**CRYSTALOMANCY:** Another very common form of divination, this technique uses a crystal ball as an aid for seeing into the future. There are many arguments among experts as to whether the answers/visions actually appear within the crystal or just within the mind of the seer, who uses the crystal only as a focus.

**EMPROMANCY:** This is divination by the studying of objects placed in a sacrificial fire, especially as to any shapes or forms seen in the smoke or the fire itself.

**GEOMANCY:** Divination by tossing pebbles on the ground and analyzing the pattern they form. The pebbles can either be special ceremonial stones, or they can simply be a handful of stones picked up on a beach.

**HYDROMANCY:** This skill requires the use of a small pool of water in which the seer analyzes the ripples and other disturbances of the pool itself.

**ICTHYOMANCY:** Very popular in cultures which depend upon fish for existence, this is divination by the examination of the entrails of a fish.

**KLEIDOMANCY:** By suspending a pendulum over an alphabet and asking questions, the pendulum is supposed to spell out the answers. A cousin to this skill today is the modern Ouija board.

**LECANOMANCY:** One of the most beautiful and most expensive of the divinatory arts, gems are dropped into still pools of water and the ripples they create are analyzed for hints about the future.

**MOLYBDOMANCY:** This is divination by observing the pattern formed by molten lead after it has been dropped onto a smooth surface.

**NUMEROLOGY:** A very popular form of divination for the last hundred years or so, this art analyzes numbers connected to a person's name and date of birth, using a very stringent system for reducing alphabetical names to numbers.

**PESSOMANCY:** This is divination by observing the size, shape, texture, etc., of a pebble drawn randomly from a pile.

**PHYLLORHODOMANCY:** Taking literally the old saw that



each flower carries a message, this technique analyzes the pattern formed by the petals and leaves of a rose to divine the future.

**PYROMANCY:** According to the practitioners of this technique, by analyzing a fire, paying special attention to the flames and any smoke or sparks, the future can be told.

**TASSEOGRAPHY:** This is the reading of tea leaves; a specialty of old women in tea houses and restaurants around the world.

**XYLOMANCY:** This technique analyzes the pattern of spikes thrown on the ground. Somewhat related to Belomancy, the best known example of this system is the Chinese "I Ching," or Book of Changes, system.

## Empathy

**Range:** 100ft area (30.5m)

**Duration:** Two minutes (8 melees) per level of experience.

**I.S.P.:** 4

**Savings Throw:** Standard; a save vs empathy means the psychic can not get a clear sense of the emotions of that particular person. To save vs empathy the person must roll to save once each melee that the psychic is using empathy. Mind block will prevent any empathic emanations from the blocked person.

Empathy is a psi-ability that makes the psychic aware of, or feel, the emotions of other people, animals and supernatural creatures. The strongest emotions are easiest to sense: hate, anger, terror, love. Feeling for emotions can often be used to establish that somebody or something is nearby, but can not be used to pinpoint an invisible or hiding person/creature. Empathy can be especially helpful in recognizing and communicating with ghosts and other supernatural creatures.

Questioning a person/being while using empathy can be very handy in establishing how they are reacting to you. In a limited sense, empathy can be used like a lie detector to see if the emotions match the verbal response. For Example: "Did you know the deceased?" The verbal answer is no, but there is a sudden flare of nervousness and fear (or hate). This doesn't mean the guy is the killer, but it might mean he is lying about knowing the dead man. Further questions might pull out a strong emotion such as anger or hate (or happiness), which may confirm the psychic's suspicions that this man might be involved in the murder. However, remember that this is, at best, circumstantial evidence and definitely inadmissible in court. Physical proof must be found, but the empathic readings may put characters on the right track. Also, remember that the empathic psychic is feeling the person's real emotions, but interpreting their significance. A very nervous person may always radiate fear or anxiety, while a cold-blooded, pathological killer may feel nothing at all and stay calm and cool as he lies through his teeth. The feeling of hate may mean that the person did know the murder victim, or knew of him, and hated him for any number of reasons. That does not mean he killed him. As you can see, interpreting emotions can be a tricky thing.

Haunting ghosts and entities rarely mask their emotions. Thus, the psychic can easily tell if one or more is nearby (within 100ft/30.5m) and what it is feeling. "I sense great sorrow." or "Do as it says! It is angry, almost crazed. I think it will carry out its threat if you try to stop it."

## Empathic Transmission

**Range:** 60ft (18.2m)

**Duration:** 2D6 minutes (2 to 12 minutes)

**I.S.P.:** 6

**Attacks Per Melee:** Equal to the individual's psychic abilities; usually 2 or 3 psi-attacks per melee.

**Savings Throw:** Standard

This incredible ability enables the psychic to instill a powerful emotion into another living creature; person, animal or supernatural being. Each psychic attack/transmission can only affect one creature at a time. Several supernatural creatures have this ability or some aspect of it.

**Despair or Sorrow:** Invokes great emotional upheaval, deep sorrow and a sense of loss. There is a 50% chance of the victim surrendering or leaving without a battle; furthermore victims are -2 to parry and dodge.

**Confusion:** Disorients the person so badly that he has no sense of direction, time, or of what is exactly going on. Victims are -3 to strike, parry and dodge, and lose initiative in any combat.

**Fear:** Invokes unreasoning terror in all those affected. Victims are -3 to strike, parry and dodge, plus there is a 66% chance that those affected will turn and run.

**Hate or Anger:** Will prompt those affected to act rashly, charge, attack, argue violently, etc. Victims are likely (60% chance) to attack, kill, harm, or betray those they dislike; +1 (yes, that's plus) to strike, -1 to parry and dodge.

**Love or Peacefulness:** Will induce a deep feeling of serenity, dispelling anger, hatred, sorrow, and so on. Hostile opponents are likely (60% chance) to reconsider their actions, deciding not to attack, show mercy, leave without being overtly cruel or destructive, halt a rampage, and so on. It does NOT make its victims docile sheep, but curbs hostility.

## Meditation

**Range:** Self

**Duration:** Varies with the person's needs.

**I.S.P.:** None

Meditation is the only ability that can be done at any time and costs no I.S.P. to perform. Meditation is not so much a psychic power, as it is a mental discipline. The character meditates by dwelling upon a single notion, mental object, or mantra (a repetitious chant or humming), to achieve a deep relaxation, focus, or to gain insight and harmony into one's inner self, nature and the universe. Meditation is often required to use psychic and magic powers.

## Mediumship/Clairsentience (Seance)

**Range:** Self

**Duration:** 2D4 minutes (plus 3D4 minutes of preparation)

**I.S.P.:** 4

**Base Skill:** 30% + 2% for every P.P.E point that can be drawn on.



Some individuals are especially sensitive to psychic impressions and can open themselves to the supernatural forces. The clairvoyance power operates on two levels. **First:** The psychic sensitive acts as a beacon, *calling* out to haunting ghosts or other entities. This makes the psychic presence known, as well as invites the entity(s) to come forth and communicate.

**Second,** the psychic acts as a *medium* through which the entity can speak (temporary possession) or as the mediator (the person who asks the questions). As the mediator of a seance group, someone other than the psychic beacon is temporarily possessed, but only the mediator can ask questions. The spirit or entity will temporarily enter the medium or psychically susceptible member of a seance group to communicate. The voice is often the voice of the spirit force, not the person, and might be in a foreign language. The entity may not speak at all, but write or draw its message. Communications are usually brief, seldom lasting more than five minutes and ending abruptly. The entity is *not* bound to answer questions truthfully, although good alignments have no reason to lie (evil entities lie freely). The person selected as the "mouthpiece" will remember nothing that occurred while possessed. If the person has latent psychic powers or much P.P.E. points, the possessing force will be able to draw on that energy reserve to create other phenomena such as telekinesis, empathic transfer, etc. The spirit's words and actions can not be controlled, making physical manifestations all the more frightening. This accounts for gusts of wind, rapping, table movement, etc. Fortunately, the possession is short-lived, or contact can be broken by breaking the chain in the seance.

The *seance chain* is composed of a group of people who sit, holding each other's hands to create a circle. The group can be a mere two people or as many as a dozen. It is pointless for the psychic medium to open himself up to a seance without at least one other, because he can not remember what happens while under the control of the entity. Another reason for having several people is that each person can feed the medium with their own potential psychic energy (P.P.E.). Each person in the seance chain can temporarily contribute up to half of his/her P.P.E. to the cause. The only requirement is to truly desire communication with a supernatural force. Each *supporter* of the communication link adds P.P.E. fuel. Each P.P.E. point increases the bases skill by +2%. The psychic medium can draw on all of his P.P.E. points, which is usually 8 or 10. Every P.P.E. point from a person *opposed* to the communication reduces the success ratio by -2%. A *nega-psychic* who is a member of a seance chain will reduce the success by -4% per each of his P.P.E. points. However, the *nega-psychic* can *observe* a seance without any ill effects. The use of the P.P.E. energies is momentary and returns to full level within minutes, but may leave some participants with a slight feeling of dizziness or fatigue for those few minutes. The seance can be broken at any time by letting go of each other's hands. **Game Master's Note:** The behavior of the ghost or entity that communicates through the medium will depend on the type of entity, its alignment and its plans. Many haunting ghosts want help if they can get it, while poltergeists are pure mischief. The more powerful, evil entities may mislead or mock the characters, or even lash out during a seance, using the participant's own P.P.E. against them. However, a seance assault is usually more frightening than deadly. The spirit force can communicate in voice, writing, symbols/drawings, or sometimes with telepathy or empathic transfer as well. A brief gust

of wind often whips up out of nowhere, small objects are knocked over or rattle about, the table may move or levitate as much as two feet above the floor and another psychic may sense the entity's emotions. The most sensational and violent seances may produce hurling objects which can inflict minor physical damage to the seance participants, ectoplasmic apparitions, empathic transmissions (usually fear, confusion or despair) and even magic spells/assaults. Regardless of the strength and ferocity of the creature's response/onslaught, the seance can *always* be instantly stopped by just one person breaking the chain of holding hands. The moment somebody lets go, the mini-circle of P.P.E. power is broken and the entity is dispelled from the host medium's body. At that same instant all physical and mental manifestations cease.

In the case of non-psychic seance attempts (ordinary people without the aid of a professional psychic or medium), the base skill is equal to the number of P.P.E. points linked by the hand holding. The person with the most P.P.E. or one with latent psychic abilities is the likely one to be selected by the entity to communicate through.

## Mind Block

**Range:** Self

**Duration:** 10 minutes per level of experience.

**I.S.P.:** 4 (per each duration period)

This is the ability to completely close or block oneself from all psychic/mental emanations. When intentionally closed to supernatural or psychic forces the character can *not* sense anything, can not use psychic abilities, nor be influenced by others. A mind block will prevent penetration of telepathy, empathy, hypnotic suggestion, and empathic transfer. It can be an invaluable protective mask when dealing with malevolent psychic forces. Adds a bonus of +1 to save vs all psychic and mental attacks.

## Object Read (Psychometry)

**Range:** Touch

**Duration:** Varies; usually about 2D6 minutes.

**I.S.P.:** 6

**Savings Throw:** None

**Base Skill:** *Impressions:* 56% + 2% per level of experience.

*Images:* 48% + 2% per level. *Present:* 38% + 2% per level of experience.

This uncanny ability enables the psychic sensitive to receive impressions and images from an object regarding its use, history and last owner. This is done by holding the object and concentrating on a specific line of thought or opening up to general impression (the latter is always more vague and random). Just as a psychic must open himself to sense evil or magic, he must open himself to the object. If successful, he will receive impressions and/or images revealing bits of information.

**Impressions include:** General alignment of its last owner (good, selfish, evil), general emotional state of mind (anger, happy, sad, hate filled, confused, etc.), the object's general purpose (what it is used for), whether or not the last owner is living or dead, and whether the item has been used with/by magic or supernatural forces. Object read will also conclusively indicate whether the item is currently enchanted or contains a supernatural force/entity (as well as *its* alignment and emotions).



If the item is possessed, an object read makes the reader totally vulnerable to psychic attack (no bonuses to save).

**Images:** The psychic can also see images of isolated events which have happened in the past. This will provide brief *snippets* of images and events that will offer glances of the previous owner and others close to him. Traumatic and emotion filled events/images are the easiest to see. Impressions will accompany the images, adding to the story as it unfolds. *Information includes:* approximate age, height, weight, build, race, sex, sometimes occupation, hair color and length; special facial or body features, such as a scar or tattoo or beard (very often the exact facial features are out of focus, blurred or obscured); the object's use/purpose; and some special event, usually very traumatic, important or happy. Often the event image will be fragmented as if it was a piece of movie film edited by a crazy man. The event will always be one in which the object was involved in some way.

**The present can also be glimpsed,** but costs an additional 4 I.S.P., with no guarantee of success. Sometimes the psychic can focus in to see and feel the last owner as he or she is at that very moment. This will provide an idea of what is his current state of mind/emotion, appearance/dress, general location (that is to say, a bedroom, office, street, outdoors, etc. No address or sense of close or far is provided), general features (shaved his beard, dyed hair, etc.) and so on. The psychic may be able to identify a place or person by feature, if he has seen it before or runs into it/him in the near future.

**The success or failure of an object read:** roll percentile dice once for impressions and once for images. The roll must fall under the character's base skill ability to succeed. A roll higher than the base skill means a failure and the psychic feels and/or sees nothing. Impressions and images are two different things, so *roll for each*. The psychic may get no impressions, but see images or vice versa. The present can *not* be seen unless the psychic was successful on at least one of the previous read impressions or images rolls. Once an object has been read it can *not* be read again by the same psychic, even if he did not see or feel a thing. Of course, the psychic can attempt to object read other items, but each attempt will cost 6 I.S.P.

## Presence Sense

**Range:** 120ft/36m area

**Duration:** 2 minutes (8 melees) per level of experience.

**I.S.P.:** 4

**Savings Throw:** None

Presence sense is a sixth sense which will alert the character to the presence of supernatural and magic creatures in the area. The ability can not pinpoint the location of the presence, but will give the psychic the impression of whether it is near (within 50ft/15.2m) or far (beyond 90ft/27.4m). It will also give the character a vague idea of how many presences there are; one (1 or 2), a few (3 to 6), several (7 to 14), or many (15 or more). The psychic can also sense human presences, but with much less accuracy. It is more of a feeling of "We are not alone." The person's distance is undeterminable and the number of people is limited to a sense of one or two or many (and that is only right 50% of the time).



## See Aura

**Range:** 60ft and must be visible.

**Duration:** 2 melees (30 seconds)

**I.S.P.:** 6

**Savings Throw:** None, but a mind block will hide the presence of psychic abilities, the level of P.P.E., and possessions by a supernatural force.

All things, organic and inorganic, have an aura. The aura has many distinctions and can be used to see or sense things invisible to the eye. *Seeing an aura will indicate the following:*

- Estimate the general level of experience. Low (1-3), medium (4-7), high (8th and up).
- The presence of magic (no indication of what or power level).
- The presence of psychic abilities.
- High or low base P.P.E.
- The presence of a possessing entity.
- The presence of an unusual human aberration which indicates a serious illness, non-human, or mutant, but does not specify which.

**Note:** Can not tell one's alignment from "see aura".

## See The Invisible

**Range:** 120ft/36m distances.

**Duration:** 1 minute per each level of experience.

**I.S.P.:** 4

**Savings Throw:** None

The character can see forces, objects and creatures which can turn invisible or are naturally invisible. Even if the creatures have no form per se, the psychic will be able to discern the



vaporous image or energy sphere which is the being. This includes ghosts, entities and the astral body.

## Sense Evil

**Range:** 140ft/42.7m area.

**Duration:** 2 minutes (8 melees) per level of experience.

**I.S.P.:** 2

**Savings Throw:** None

This psi-power is a much more refined ability to feel the presence of evil. All supernatural creatures radiate their alignment, good or evil. A psychic sensitive will automatically feel supernatural evil without spending a single I.S.P. However, to get a clearer picture of the evil force(s) the character must open himself and use the sense evil ability.

The sense evil psi-power will indicate the general number of *supernatural evil*: one, a few (2-6), several (7-14), or many (15 or more). It can also register the intensity of the evil and pinpoint the general location of the source(s) to a particular room(s), possessed object or person, or distance; i.e. very near (within 15ft/4.5m), near (within 50ft/15.2m), or far (60 to 140ft/18.2 to 42.7m). The character can track the source of supernatural evil, like a bloodhound, by sensing how close it is to him.

Evil emanations from human beings are much less distinct and can *not* be felt unless the source-person has an immediate evil intention and has psychic powers or is psychotic. The former can mask his evil intentions with a mind block.

## Sense Magic

**Range:** 120ft/36m area

**Duration:** 2 minutes per level of experience.

**I.S.P.:** 3

**Savings Throw:** None

The ability to sense magic is much like the sense evil psi-power. The psychic can feel magic energy, tell whether it is near (within 20ft/6.1m) or far (up to 120ft/36m away) and follow the emanations to pinpoint their source as a particular place, room, person or object. **Note:** Invisible, magical supernatural creatures or objects can only be traced to a general area, like a specific room or corner. The psychic will also be able to sense whether or not an object has magic powers, if a person or item is enchanted/under a magic spell (this does *not* include psychic powers), when magic is being used within the area (120ft) and when a person is casting a spell (users of magic do *not* radiate magic energies until they call upon them).

## Sixth Sense

**Range:** 90ft/27.4m

**Duration:** Until the danger passes or happens.

**I.S.P.:** 2

**Savings Throw:** None

The sixth sense is a power that gives the psychic a precognitive flash of imminent danger to himself or somebody near him (within 90ft). The character will not know what the danger is or where it will come from, nor who it will be directed at when in a group. All he will know is that something life threatening will happen within the next 60 seconds (4 melees)! The sixth sense is triggered *automatically*, without the consent of the psychic, whenever his life is in great peril or the life of somebody he greatly cares about (friend, loved one, etc.). The sixth sense

is only triggered by an *unexpected, life threatening* event which is already set into motion and will happen any second. The power *can not* be called upon at will to sense for traps or ambush. Instead, it works like an automatic reflex. If the character has used all his I.S.P. the sixth sense is temporarily rendered inoperative.

### Bonuses:

The sudden flash of insight provides the following bonuses. All bonuses apply only to the initial *melee* when the attack occurs.

+6 on initiative roll

+2 to parry

+3 to dodge

The character can not be surprised by a sneak attack from behind.

## Speed Reading

**Range:** Self

**Duration:** 3 minutes per level of experience.

**I.S.P.:** 2

This is the ability to read and comprehend the written word extremely quickly. Speed of reading is 30 pages per minute/4 melees. The psychic will retain the information as he would normally. Highly technical texts will reduce the speed reading by half (15 pages per minute) and may require two readings.

## Suggestion (Hypnosis)

**Range:** 12ft/3.6m, with eye contact.

**Duration:** Varies with each circumstance and subject; rarely more than a few hours maximum.

**I.S.P.:** 2 per idea or attempt to implant an idea.

**Savings Throw:** Standard

The power of suggestion is a psychically boosted form of simple hypnosis. The power is limited to relaxing/calming somebody down, putting a person or animal in a light sleep, helping a person to relax and focus on a particular thought (good for helping someone to remember things) and implanting subtle ideas. The implanting or "suggestion" of an idea must be subtly worked into a comment. The suggestion must be kept simple and clear, such as "You know you can *trust* me" or "You feel like you *have a fever*. Yes, you do have a *fever*. You're burning up (with *fever*). You should *lie down*." or "You don't want to go there." The power of suggestion can also be used to make the victim imagine sounds and images. "Did you hear that? Listen! *Footsteps!* You hear the *footsteps* . . . yes, you do!" Or, "At *midnight the spectre appears*. Everybody who is ever present *sees the spectre at midnight*." The poor individual who fails his savings throw will, indeed, imagine he sees something at midnight.

The power of suggestion can *not* make a person think he's a chicken, nor does it make a person the psychic's charmed, zombie slave that obeys his every command. It simply soothes or implants a notion into someone's thoughts. Sometimes that little bit can be an important edge.

**Note:** A successful save against a suggestion means the idea is not implanted. The psychic may try again (at the cost of another 2 I.S.P.).



## Summon Inner Strength

**Range:** Self

**Duration:** 10 minutes per level of experience.

**I.S.P.:** 4

This psi-power enables the character to draw on his inner reserves of strength to ward off pain and fatigue. Every time the psychic calls upon his inner strength the following bonuses apply:

- Add +10 S.D.C.
- Add +2 to save vs poison or toxins.
- Add +5% to save vs coma/death.
- Fatigue is temporarily forgotten and the character can function as if he was fully rested for the full duration of the summon inner strength power.

## Telepathy

**Range:** Read surface thoughts up to 60ft/18.3m away or two-way telepathic communication — 140ft/32.7m.

**Duration:** 2 minutes per level of experience.

**I.S.P.:** 4

**Savings Throw:** Conditional. When a person suspects that he is being telepathically probed he can resist, getting the *standard* savings throw. Mind blocks will completely prevent telepathic probes or communications as long as the block is up.

The power of telepathy allows the psychic to eavesdrop on what a person is thinking at a particular moment. This is done by focusing on that one person and picking up on his or her

surface thoughts. *Surface thoughts* are those thoughts and musings uppermost in a person's mind. A deep probe into memory is not possible. Although the psychic can read the thoughts of several people, he can only do so by focusing on *one* person at a time. Simultaneous, multiple mind reading is impossible for the character.

Limited telepathic communication is also possible. The telepath can *send* a directed thought message to one person at a time. The message must be as brief and clear as possible. Like, "John, I need you immediately. Hurry!" or "Stop! Don't do that." "Come here," "Look Out" or "Press the green button." However, two-way telepathic communication is not possible except between two telepathic psychics.

## Total Recall

**Range:** Self

**Duration:** Permanent

**I.S.P.:** 2

The character remembers every word he reads. Specific blocks of information can be recalled in perfect detail at will. Each block of information costs 3 I.S.P. to recall in absolute detail. If all I.S.P. have been expended the memory is a little fuzzy, so that exact quotes and details may be impossible to recall. *Roll percentile:* 1-50 — remembered in full detail, word for word; 51-80 — details are forgotten, but the full essence of the ideas are clear; 81-00 — can only recall the most basic concepts; no details nor strong comprehension.





# THE SECRETS OF MAGIC

**Please Note:** Throughout this section magic is treated as a real, existing force complete with theories and historical references. This is done only for dramatic purposes. We must again express that this is a purely fictional work and has absolutely no bearing *on the real world!* Really!!

Magic is an enigma that has haunted mankind throughout the centuries. Is it real or make-believe? And if real, how does it work? Will it allow man to reach new heights or destroy him? Must one consort with demons or can it be used for good purposes? These are just a few of the hundreds of questions regarding magic. Much of magic's secrets are lost to confusion, inaccuracy and ignorance. Others are jealously guarded by individuals and cultists who believe they alone command true magic. Yet so-called "magic" power is rooted not in myth or the supernatural, but in nature and the composition of the universe. It is an energy source that human beings can learn to control with spectacular results.

## THE MAGIC SYSTEM

Magic is, paradoxically, both simple and complex. The complexity lies in the difficult mental disciplines which *must* be mastered and the lifetime study required to find "true," usable, magic knowledge. The actual use of magic, once one has learned how, is easy. This is reflected in the very simple game mechanics. All magic requires two things: 1) Mystic Knowledge and 2) Sufficient Potential Psychic Energy (P.P.E.).

## STEP ONE: BELIEF

The most difficult aspect in the mastery of the mystic arts is belief. The practitioner of magic must absolutely believe that magic is real, it exists, and that he or she has the knowledge and skill to perform magic. This must be 100%, unwavering conviction, not just self-confidence. An individual can not even consider pursuing the mystic arts without absolute belief. The tiniest nuance of uncertainty will destroy any chance of learning magic. It is an obstacle that most people (94%) can *not* overcome. The belief that magic is pure fantasy is too strong in the modern civilizations of the world.

Since most people do not truly believe in magic, it is lost to them. The citizens of a hustling, bustling metropolis could live out their lives completely oblivious to the ley line and nexus of invisible potential psychic energy that pulses through the heart of their city. For them, it simply does not exist. Thus, it is not real.

Only the arcanist and, to a much lesser degree, the parapsychologist can use magic. All other characters, even if they believe in magic, have converted their personal potential psychic energy into other areas of *psychic* development. Once the P.P.E. is converted it can never be regained, so none of the other psychic character classes can learn magic. However, with the exception of the nega-psychic, any character can participate in group magic and use most magic artifacts (reading a magic scroll or spell is not included).



## STEP TWO: MENTAL DISCIPLINE

Theoretically, anybody can learn to use magic; however, it is an extremely difficult process that proves to be impossible for most people. ALL magic draws on what parapsychologists call *potential psychic energy* or P.P.E. It is as good a designation as any. Potential psychic energy is present in all living creatures, even if only in a minuscule amount. **Psychics** are able to draw on that energy and focus it to create a handful of amazing *psychic abilities*, such as levitation, telekinesis, ectoplasm, clairvoyance and others. The psychic's orientation and focus permanently



changes potential psychic energy into psychic energy abilities and inner strength points (I.S.P.). This *conversion* of potential psychic energy is the source of their psychic powers. Only a small reserve of P.P.E. is retained. Does this mean psychic abilities are really magic? No, not really. The potential psychic energy, which is the essence of magic, is a natural energy that the psychic inadvertently draws on and changes into a permanent psychic energy base (I.S.P.). A psychic can never use his I.S.P. for magic or vice versa. While the psychic energy and powers share a common root with so-called "magic" energy, they are two very different things.

**The dedicated practitioner of magic**, usually called an arcanist or mage, has learned to draw upon his own P.P.E. reserve without changing its essence. Furthermore, the arcanist learns to nourish and cultivate his potential psychic energy. The difference between men of magic and psychics is that the psychic transforms P.P.E. into psychic energy, while the arcanist is a receptacle for unmodified mystic energy, effectively becoming a living battery for potential psychic energy. Like most batteries, the arcanist can learn to contain that energy, release it and recharge, as well as link with other power sources. The trick is learning to recognize that energy, how to contain it and then how to use it.

To utilize magic the character must learn mental disciplines akin to Zen or Oriental meditation. The individual *must* be able to completely rid himself of distracting thoughts and emotions, to concentrate on one thought, one razor sharp focus, in order to direct magic forces. To be an effective mage, the character must take this art of concentration a step further and be able to relax, clear his mind, and focus under the most distracting and frightening conditions. It is a meditative art that must be learned to perfection. Unfortunately, the human mind is a cluttered and complex machine that is not easily mastered. Thus, the meditation skill alone will require *years* of intense practice to conquer and must be continued daily to keep sharp. The pursuit of magic is not for the impatient.

## STEP THREE: UNDERSTANDING MAGIC

### Good or Evil

It is the intangible, metaphysical aspect of "the power" that has eluded or confused mankind for eons. Magic or potential psychic energy is a natural resource; it exists silently, waiting to be used. The energy is neither good nor evil. Rather, it is a force that can be taken and molded by intelligent creatures for any purpose, exalted or despicable. It is the user of the magic and his purpose that dictates good or evil. Ignorance and stupidity can also lead to evil by unleashing demonic creatures or deadly forces.

### Types of Magic

Magic is an energy that can be controlled and manipulated by the human mind and force of will. It is a fabulous power that can create a storm or fire an energy bolt, or open a door to another world. It is a force that requires no external casing or internal mechanism to use; only the mind. It seems to be an inexhaustible energy that continually renews itself. A force of nature that can be harnessed by a single individual. Because the history of man spans the world, we see countless beliefs, reli-

gions, rituals and legends of magic. Throughout history, particularly driven individuals have learned to draw on the incredible energy. Whatever methods, rules and practices they used became the whispered and coveted way to magic.

In many instances, these methods were believed to be the only true forms of usable magic. The only apparent means to access "the power." Secret traditions and rituals were soon created to preserve, protect and conceal the secret way. Over the centuries, a dozen or so different, dominant types of magic have been developed. The irony is that each specific type of magic, no matter where on earth or when in time, draws on the same energy. The rituals, techniques, disciplines, components, and philosophies are completely man's own device. Each simply represents one of the countless methods in which man can draw on the mystic energy. Each method is restricted by its own laws, purpose and perceptions, much like schools of philosophy or the vast variety of martial arts. Each is similar in some respects, but very different in others; although the uninitiated may see no or little difference at all. Each magic, regardless of its name, whether it be called wizardry, druidism, witchcraft, necromancy, conjurement, voodoo, thaumaturgy, alchemy, phantagenics, phytynic power or sorcery, is but one focus, one means, of manipulating the *same* raw potential psychic energy (P.P.E.). This is not to imply that each is the same or that someone can simply make up their own magic, only that each draws from the same energy pool.

Each school of magic has its own philosophy and approach to harnessing magic. The philosophy, practices and rituals serve very important, concealed functions. The words of a spell or ceremony are usually designed to intentionally focus the participant's concentration. Sometimes there is *repetition*, like a mantra chant used in meditation, to clear the mind and focus on one particular thought or nothing at all. Often the chant will be intentionally *paced* to build a mental and emotional momentum. *Timing and intensity* of thought and emotion are usually key elements in successful magic. The various specific types of magic provide their practitioner(s) with an immediate orientation, focus and that all-important confidence that magic is real and attainable because it has existed for centuries in this form.

The true student of magic (the arcanist) may study several types of magic in order to recognize their powers and practitioners whenever they are encountered, but will select and *practice* only one. The type of magic selected will always reflect the individual's ethics, attitudes and alignment. For example, an arcanist with a good alignment would not use voodoo or necromantic magic, both of which call upon demons, evil forces and blood sacrifices, and are generally used to hurt, scare and enslave other people and supernatural beings. An evil character, on the other hand, may find such purposes, and the foul rituals involved, to be stimulating, and serving to intensify and focus magic for his or her own evil motives.

## STEP FOUR: UNDERSTANDING P.P.E. AND MAGIC

ALL magic requires two things: 1) Mystic knowledge and 2) sufficient potential psychic energy (P.P.E.). Specific words, components, rituals and ceremonies are all elements used to achieve magic and fall into the first category of "mystic knowledge."



Players will find that every magic invocation, be it a spell or ritual ceremony, will always require the expenditure of potential psychic energy. Each magic invocation will have the letters P.P.E., followed by a number to indicate how much energy is required to create that particular magic effect. Generally, magic requires a lot of energy; often more energy than any one person can possibly have. That's okay because the practitioner of magic can draw P.P.E. from other individuals, some magic artifacts, and places of power.

### Drawing P.P.E. From Others

Everybody has some measure of potential psychic energy (P.P.E.). The arcanist has the greatest amount of P.P.E. because he has learned to contain, nourish and draw upon it for magic. He can use his own energy reserve to create acts of small magic. The P.P.E. will always regenerate after a short while, much like the psychics and inner strength points (I.S.P.). However, the more powerful magic requires a great deal of energy to create. This means the arcanist will have to supplement his own P.P.E. with additional, outside, energy. This can be done by linking with other people. The people can be ordinary everyday folk, psychics or other arcanists. Everybody, including ordinary people, has some degree of potential psychic energy. It may not be much, 3 or 4 P.P.E. points, but it exists and can be added to the arcanist's energy pool.

An arcanist (that's *any* user of magic) can usually draw on anybody's P.P.E. with or without their consent. If the person or people whom the arcanist is drawing additional energy from are **unaware** that he is doing so, the mage can tap up to 2D6 of their total potential psychic energy. If the people are **unwilling** and are consciously resisting the mage, then he can *not* tap any of their P.P.E.. Individuals who believe in magic and the arcanist's abilities can knowingly and willfully **consent** to give the mage up to 70% of their P.P.E., but must actively concentrate on doing so. This means they must focus on achieving the same purpose/goal or mystic result. The more intense the emotion the better. An Arcanist can *not* have his P.P.E. drained by another arcanist or supernatural creature.

**Evil arcanists** can also draw P.P.E. from individuals through *blood sacrifice*. This is your classic 'kill a virgin' which has been so publicized in horror literature. The sacrifice victim does *not* have to be a virgin; anybody with a lot of P.P.E. will do the job. Sacrificial victims are seldom used in any spell magic, but *may* be a key component for *evil ceremonial magic*. The reason for a sacrifice is that a person's P.P.E. surges at the moment of death, *doubling* in strength (animals too). In the foulest of ceremonial magic, the crescendo is the murder of the sacrificial victim, enabling the diabolical mage to tap the dying victim's doubled P.P.E., as well as his cult members' (such rituals usually involve a cult). Note: That this hideous act of evil can only be done by characters of an evil alignment; diabolic miscreant or aberrant. Any *good or selfish* characters who *willingly* participate, in any way, with a blood sacrifice of a human being will have his or her alignment immediately changed to **evil**. Principled and scrupulous characters will not even partake in the sacrifice of animals, but unprincipled and anarchist (selfish) alignments can. *Also see ceremonial magic*.

**The nega-psychic and the arcanist** are the only character classes that are impervious to P.P.E. vampirism. No arcanist or supernatural being can use the P.P.E. of a nega-psychic or ar-

canist. In fact, the presence of a nega-psychic within the range of a magic weaving mage will drain him of some of his precious P.P.E. *See the nega-psychic character class for details*.



### Cults are a Special Case!

Mystic cults or secret societies will have a dozen or more members who actively participate in ceremonial magic and rituals. While not necessarily evil, the fanaticism involving cult members is usually an aspect of evil. Fanatical individuals are irrationally and unscrupulously dedicated to one individual or cause. This fanatical loyalty, or excessive zeal, is ideal for fueling a mage with ALL the cultists' available P.P.E. (as willing pawns) *plus* an additional one P.P.E. point per each cult member stimulated from their fervor. No other mage can tap into the cult's P.P.E. if they are already, willingly, *directing* their P.P.E. to their arcanist leader. *Also see cults and ceremonial magic*.

### Limitations

To draw potential psychic energy (P.P.E.) from *unwilling or unaware* people (or animals) the mage must be within sixty feet (18.3m) and can affect only three individuals per each level of the arcanist's experience. However, an arcanist can easily draw P.P.E. from up to six *willing* participants and twice that number if the arcanist has a M.A. (mental affinity) of 22. They must also be within 60ft plus 10ft per level of experience.

**Animals** are always considered to be *unwilling victims!* Animals can automatically sense magic/arcanists and instinctively fear it. This makes them unwilling subjects who are actively *resisting* the mage so that no P.P.E. can be drawn from them. this is true even if the arcanist is of good alignment and/or the animals owner/master/friend. The **ONLY** way to draw on the P.P.E. of an animal is to kill it; blood sacrifice.

### Drawing P.P.E. from Magic Artifacts

There are some magic artifacts that act as portable P.P.E. batteries, from which a mage can add to his own P.P.E. reserve. Some are finite energy sources that are worthless when used up, while others will recharge to maximum energy level over every 24 hour period.



## Ley Lines, the Ultimate P.P.E. Source

The Earth is interlaced with a grid pattern of natural potential psychic energy. There are numerous places where that energy can be found and used for magic. They include the pyramids of Giza, Stonehenge, and others. *See the section on ley lines and places of power, which follows this section, for full details.*

## The Recovery of Personal P.P.E.

All characters automatically recover or regenerate their potential psychic energy (P.P.E.) as a natural process. **Half** of the character's P.P.E. will return within 12 hours, and **all** P.P.E. will return within 24 hours. Rest and relaxation are not a factor. Note that the percentage of P.P.E. is used rather than x-number per hour. This means if a character's total P.P.E. is six, half (three) will return in 12 hours and all six will be available in 24 hours. If the character is an arcanist with 41 P.P.E., 21 will be recharged and available for use within 12 hours (always round odd numbers up), and all 41 P.P.E. will return in 24 hours.

## STEP FIVE: SPELLS, RITUALS AND SUMMONING

Historically, there are dozens of different approaches, principles, practices, and philosophies of magic. To describe each would fill a book of its own. Furthermore, many are just variations of one another or derivative of the same basic, inspiring source. Consequently, for game purposes, we will address the three basic types and approaches to magic, rather than specific schools of magic philosophy and practice, like voodoo. Please note that the following data is pure fiction, inspired by ancient myths and decades of horror genre literature and movies.

### SPELL MAGIC

There are three major types of magic: spell, ritual and summoning. **Spell magic** is a versatile, compact and portable approach to magic. It seldom requires components and can be performed by the arcanist without elaborate, time-consuming ceremony or the need for cultists.

*To perform spell magic*, the arcanist must have conquered the mental disciplines and be able to dive deep within himself, draw on his own P.P.E. (which can be supplemented by other sources around him), and focus it to create magic. The spell itself is a string of words, much like a meditative mantra, which serve to help the mage to concentrate and focus his thoughts. As usual, the real power lies within the practitioner of magic, but the right words are required to unleash that power. The mage must be truly confident and absolutely positive that the words, the spell, *will* create magic, or nothing will happen. It is the exceptional individual who is so supremely confident that he or she can devise his own brand of magic and create his own series of working magic spells. Such an individual *may* appear once every few centuries. Thus, men of magic must unearth existing spells, created by others, which they can truly believe in because history has proven it to be real or the mage has seen the spell in action with his own eyes. This is where apprenticeship with a master mage is ideal, for it is much easier to believe in something you have witnessed in person than to believe in a theory or a supposedly real incident related in writing. The intimacy and trust of personal involvement is always a benefit. Unfortunately, it is a rarity, especially in our modern world, to find a true master

of the mystic arts who is willing to train a person in the rigors of magic's mental discipline, let alone share *any* of his magic spells or ritual knowledge.

*Spells* are excellent in that they can be used quickly, without pomp, ceremony or components. The spoken word and immediate focus of concentration (a mild trance) means a spell can be created almost instantly, once or twice per melee (15 seconds). **The limitation** is that spell magic is only effective in using low level spells that require as little potential psychic energy as possible. The more powerful spells require greater amounts of P.P.E. than the mage may personally have, or one spell may use up all of his P.P.E. Although the mystic can draw additional P.P.E. from other characters, it mandates even greater concentration and reduces the number of spells possible per melee to one every two melees (30 seconds). The most powerful spells will be impossible without a ley line nexus or some other source of *massive* potential psychic energy. Furthermore, powerful magic will demand lengthy mental preparation (i.e. meditation and concentration) that may stretch into several minutes or even hours. **NOTE:** Each spell will indicate if additional preparations or time are required.

### Ritual Magic and Cults

*Ritual or ceremonial magic* usually involves the more powerful magic invocations, has multiple participants, and utilizes components, circles, symbols and other ceremonial items. This is where cults, covens and secret societies spring from. These mystic organizations consist of fanatical individuals selected for their excessive and irrational zeal and high levels of potential psychic energy. A magic cult or secret society will have *one* leader adept in the mystic arts. It is he (or she) who directs and motivates the group. In most cults the leader is supreme, with perhaps one, clearly submissive, assistant or aid who may be able to assume the mantle of leadership if the supreme leader is eliminated. The rest of the participants are fanatical believers, acolytes or the faithful, who have devoted their lives to their leader and "the cause" (whatever the cause may be). The believers rarely know anything about magic; not spells, mental disciplines nor mystic lore. They are dedicated to a cause, a belief or an individual. Although they gladly participate in magic ceremonies they have no inkling of the how's and why's behind it.

It is the fanatical cultists' excessive and unscrupulous dedication that makes them the ideal pawns of maniacal men of magic. A capable mage can whip his minions into a frenzy *to get ALL of each members' P.P.E. (+1)!*

Rituals and ceremonies are designed to stimulate the participants (almost hypnotically capturing their attention) provide a riveting focus, and slowly, methodically, build their excitement to a fever pitch. The end of the ceremony is the climax; a grand crescendo that has its followers on the edge of their seats. The potential psychic energy at its maximum is unleashed with one final act or verse from the leader, enabling him to draw on the full amount of psychic energy. Effectively, many individuals are made to function as one, with one identical goal. A dramatic focus of potential psychic energy gleefully given to the arcanist who leads them.

Most ritual and ceremonial magic is intended to be vehicles for group involvement. While ley lines and places of magic can provide vast amounts of mystic energy, they are relegated to specific locations and moments of celestial alignments. A cult







can provide great P.P.E. without the benefit of natural places of power. For Example: A dozen cult members with an average of 12 P.P.E. each (usually only individuals with high P.P.E. will be recruited) will provide the wizard with over 150 P.P.E., in addition to his own P.P.E. base. A formidable amount of mystic energy available as often as every 24 hours. Now, combine the power of a cult with a ley line nexus and the mage's power is doubled or quadrupled.

### Limitations of Ceremonial Magic

The obvious benefit of ritual or ceremonial magic is the immense amount of energy it can unleash. However, there are some drawbacks.

1) Rituals require a lot of preparation and time to execute. Remember, the participants are not trained in meditation or any of the mental disciplines needed to draw on one's P.P.E. Consequently, it is each member's faith and participation in the ritual that manipulates their emotions and focuses their intentions to release and direct their reserve of potential psychic energy. Thus, a typical ritual will require anywhere from 20 minutes to 2 hours to invoke the magic.

2) If the ritual is interrupted for more than a few moments (2 melees/30 seconds), the groups' trance is broken and the ceremony must be started again from the beginning. The emotional letdown caused by the interruption will reduce the total available P.P.E. by 30% if the ceremony is tried again within less than 24 hours. If the ritual is incomplete or altered, it will be ineffective.

3) The most vulnerable target of any ceremony is the leader. Incapacitate the leader and no magic will be possible. Remember, cult members have no in depth knowledge of the mystic arts. However, they will physically lash out to *destroy* any force that dares to threaten their leader or goals. There is also a chance (30%) that the leader's right-hand man may know enough magic to be a magic threat, or able to reorganize the cult if the leader is lost. **Note:** The cult leader's right-hand man is rarely more than a second level arcanist. This means it will probably take a year or two to reorganize (the leader should be at least 4th level).

4) The optimum number of participants is the mage/leader and a dozen followers. To successfully manage and manipulate a group of 13 to 20 individuals, the mage must have a mental affinity (M.A.) attribute of 17. For a group of 21 to 32, the arcanist must have a mental affinity of at least 22. And to lead a group of 33 to 56, the arcanist must have a mental affinity of 26 or higher. **Note:** The overall number of members in a secret society can number into the hundreds or thousands with supporters and peripheral activists; but the inner circle, the core group who are the true fanatical participants of the mystic cult leader, is limited as described. It is likely that the secondary members of a large cult will act as the first line of defense and front men for the covert magic organization.

5) Ritual magic tends to involve the manipulation of others, and *may* include acts of cruelty or blood sacrifices. Characters of a good alignment will never participate in any ritual that will compromise their alignment. If they do, their alignment will be immediately reduced to one of the selfish or evil alignments, depending on the degree of selfishness or evil involved in their actions. Good characters will NEVER actively lead or participate in a cult because of the unscrupulous activities and manipulation

of others. Only the anarchist and evil alignments will organize a cult.

Of course, the great power offered by a cult or secret organization/worshippers will always be alluring to certain power hungry individuals. The concept is ideal for ruthless arcanists, because it provides a great deal of energy, there are no shared secrets and, thus, no threat to the mage from within the organization. He or she is the ultimate authority and power of the group. Some of the more intelligent and powerful supernatural beings will use cults to bolster their magic powers.

### Summoning and Cults

Summoning is a *ritual magic* that either creates a dimensional rift that allows a supernatural being to enter our world to do the bidding of the mage who summoned it, or enables the mystic to draw power from a supernatural creature. The allegiance with purely evil beings, and the acts of evil so often needed in the rituals, means that only characters of an anarchist or evil alignment can ethically perform many summoning rituals. Frequently, the summoning mage must prove his commitment to evil by offering a blood sacrifice or by making a pact with the powerful supernatural being. It is from summoning magic that the legends of necromancy and demon worship are derived. Since it is usually evil sorcerers who partake in summoning magic, these self-serving fiends have no compunction against using cultists as their stepping stones to power.

*Summoning magic includes* calling forth and enslaving entities and demonic forces, bridging dimensions, unholy allegiances with super-powerful beings of evil, possession, demonic familiar, and commanding so-called demon hordes. It is important to point out that not all summoning magic demands blood sacrifices or pacts with demons, so there are many rituals that arcanists of a good alignment can use. However, the forces called upon are always evil and treacherous; thus, they will be quick to destroy, torment, or trick good characters. As a student of the mystic arts, the arcanist will study *all* magic, including summoning. Knowledge has many uses.

This knowledge of summoning magic will enable an arcanist to recognize dangerous rituals, specific cults, the mage's intentions (good, evil, foolish), components, special requirements, the dangers involved, and even the type of demon(s) being summoned. Knowledge of ceremonial magic and cults will also provide the character with the knowledge needed to thwart or counter the ritual. **Note:** Circles, symbols, costumes and components are used exclusively in all ritual magic, and to scare off intruders.

## STEP SIX: THE PURSUIT OF MAGIC

The search for and mastery of, real magic spells, rituals, artifacts and places, is a difficult task that challenges the arcanist throughout his life. As mentioned earlier, it is very nearly impossible to create your own magic spells and rituals, even though all magic is powered by the same energy. It is a rare individual who can develop his or her own school of mystic philosophy and working magic. **Game Master Note:** No player character should be able to create new magic spells of his own unless he/she is at least a 7th level arcanist, has a Mental Endurance



(M.E.) of 17 or higher, a Mental Affinity of 14 or higher, and is extremely self-confident and/or driven. Even then, there is only a 16% chance of success. If the first *three* attempts are all failures (can be the same spell or 3 different), the character's self-confidence is irreparably shaken and the odds of success plummet to 6%. If each of his next *three* attempts fail, the chance of success drops to 3%. If the character persists in his efforts to design his own magic, he will get a dozen chances at the 3% success ratio (no more than three consecutive rolls at any one time). If all 12 attempts fail, the arcanist's confidence is shaken to his roots. Permanently reduce all P.C.C. magic skills by 5% and no other attempts at creating magic are possible. One or more successes with the last 12 will restore confidence, push future success possibilities back up to 6%, but the 5% skill penalty is lost forever. 12 or more consecutive failures, despite previous successes, will cut the success ratio to half, where it will remain from then on. An early success at 16% or 6% will boost confidence and add +2% to the success ratio, but 6 consecutive failures thereafter will drop the success ratio by half, where it will forever remain.

Obviously, it is much easier and safer to find and utilize magic which has been created by others and, over the centuries, proven to be functional. Yet, even this can be a task. There is a great deal of time and energy involved in ferreting out truth from myth. Real, working, magic spells, rituals and information (true history, background, purpose, etc.) are hard to find. Frequently, those who have learned the secrets of magic intentionally keep their knowledge hidden and refuse to share it. Much mystic knowledge has been destroyed, forgotten or lost to posterity. What knowledge does remain is buried within superstitions, myths, legends and out-and-out fiction. Often the knowledge is in scattered fragments, or distorted so that no one source holds the complete answer. There is so much mistaken, misleading, incomplete, and just plain wrong data concerning magic, that it is a chore just to recognize elements of authentic magic.

### Determining Mystic Knowledge

ALL arcanists (any practitioner of magic) will have a general knowledge about most spells and rituals. That is to say that they are likely to have read about it, heard references to it or seen it once or twice before, but do *not* necessarily know how to perform the magic. It's like real life stage magic. We've all seen various magic tricks dozens of times. I'm pretty certain how some of them are done and a few I have read about in detail so I know exactly how they are performed, but I could not perform them. On the other hand, there are a handful of simple tricks and illusions I could perform if I continued to practice the routine. Then, there are others that are a complete mystery. In this game, magic knowledge works the same way. Just because the character knows about magic, it doesn't mean he knows everything. He might recognize an artifact, or the words of a spell or ritual, or understand what is happening (and perhaps how to stop it), but it does not insure that he can do that exact same magic himself. It is also possible that the mage can create a similar or identical feat of magic, but he uses a completely different spell or ritual to achieve the same goal. Don't forget that there are several schools of magic philosophy and technique. The game master should use the character's "real" experiences in previous adventures, his skill level as it relates to his understanding the principles of magic, and related skills, such as the various lores and lan-

guages, to determine whether or not the character can figure out what's happening. **A G.M. Tip:** Always let the player formulate some idea of what is going on. Even if he or she comes to the wrong conclusion, it can add real flavor and anticipation to the game.

*The search* for mystic knowledge is an all-consuming passion that carries the arcanist from adventure to adventure. It is his insatiable thirst for that knowledge that compels the character to pore over books, study history, collect ancient artifacts, examine myths and legends and superstitions with a fine-toothed comb, visit reputed places of magic, collect articles and reports of strange phenomena, and personally investigate odd occurrences which might be linked to magic.

### Specific Magic Incantations

Spells and ritual invocations can be learned from other arcanists, from some of the intelligent supernatural beings, and from the written word (such as a book, diary, scroll, etc.), or pieced together from several sources (usually involving old manuscripts and hearsay). A player can tell the game master that his or her character is searching for a new magic invocation or a specific invocation, but it is up to the game master's discretion as to whether the character is successful or not and how long it may take.

Just because the character is looking does not mean he will find anything. First he must know where to look, know what he's looking for and be able to recognize it (or part of it) when he sees it. I would dearly love to find a million dollars in my back yard, but years of searching would prove fruitless. One: It's a ridiculous thought. Two: What would a million dollars be doing in my back yard. This is not a logical place to find that kind of money. Three: If by some miracle there was a precious gem or artifact buried in my lawn I'm not likely to recognize it and may throw it in the garbage or leave it where it lay. This silly example clearly dramatizes the type of things a game master must consider whenever a player makes that kind of request. If the character has a "real" reason to believe some iota of magic data is nearby and is looking in the right place, then, maybe he or she will find something. Maybe! Magic is rare and obscure. It may require years of searching to uncover anything, let alone a specific item or incantation. Game masters, don't let magic imbalance your game. You should get an idea of what *you* and your players can handle before you start doling out magic left and right. Take it slow at first, and make it a point of not getting carried away unless you and your players are looking to play outrageous and high-powered adventures.

### SUGGESTED RULES FOR DETERMINING AND ALLOTING MAGIC KNOWLEDGE

**ONE:** *ONLY* the **Arcanist** and **Parapsychologist** have skills in using magic incantations, so none of the other characters should have more than a passing interest in the hard, cold, facts of magic. Likewise, it is pointless for any other character to desire or hoard scrolls or mystic texts, except to keep it out of the hands of those who can use them (if that's true, he'd be more apt to destroy such items).

**TWO:** **The Arcanist** will start, at level one, with a comprehensive knowledge of magic and at least sufficient mastery over the other disciplines. This means the character knows everything he needs to know to perform any type of magic. But



there are restrictions caused by alignment and limited knowledge.

**The Arcanist's alignment** will, periodically, prevent the character from using some types of magic. A good character will avoid necromancy, voodoo, alliances with demons, willful enslavement of others (including supernatural and evil beings) and human sacrifices (blood sacrifices in general). The character's alignment will always influence the types of magic incantations selected, although, technically, the mage *can* perform any magic.

### The Initial Magic Knowledge of an Arcanist

The player playing an Arcanist must roll four-sided dice to determine how many spells the character knows per each level of magic. *The levels of magic* indicate the complexity of the invocation, the scarcity, and P.P.E. cost. The higher the magic level the more costly it is to use, the longer it takes to cast and the more difficult it is to find. *See the magic invocation section for specific spells/rituals.*

Once the number of magic invocations are known for each level, the player makes his *selections*. **Note:** The player is limited to only the number of invocations he has rolled for each individual level of knowledge. He/she can not adjust the *number* of invocations in any way. **For Example:** Malcolm rolls one six-sided die (1D6) to determine how many invocations his character knows from each of the first six magic levels. He rolls a 4 for level one, 3 for level two, 6 for level three, 5 for level four, 2 for level five and 4 for level six. Malcolm must now select which of the 4 invocations he knows from the ten (total) first level magic. He selects 3 from the ten second level invocations, 6 from level three, and so on. He can not take two or three of his third level selections and apply them to his measly two fifth level, or decline to take any first level knowledge and apply them to second level. Mystic knowledge is very random and difficult to find. It is common to know many of one particular level of magic and almost none of another. It's a matter of fate, chance and luck (in game mechanics, the luck of the dice). Remember, the levels indicate the complexity and rarity of the magic and have nothing to do with the experience level of the character. A first level Arcanist can know many high level magic invocations.

### At First Level of Experience the Arcanist Knows:

1D6 Level One Invocations  
1D6 Level Two Invocations  
1D6 Level Three Invocations  
1D4 Level Four Invocations  
1D4 Level Five Invocations  
1D4 Level Six Invocations  
1D4 Level Seven Invocations  
1D4 Level Eight Invocations  
1D4 Level Nine Invocations  
No Level Ten Invocations  
No Level Eleven Invocations  
No Level Twelve Invocation  
No Level Thirteen Invocations  
No Level Fourteen Invocations  
No Level Fifteen Invocations

### Spell or Ritual

The player must also decide whether the knowledge is a spell incantation or a ritual/ceremonial rite. Spells and rituals are two completely different approaches to magic. This means that each time an invocation is selected, the player must state whether he wants it to be a spell or a ritual; the character does *not* automatically know both. However, things are not as grim as they sound. The player also rolls four six-sided dice (4D6) to determine the number of invocations for which the arcanist **DOES** know both spell and ritual knowledge. The selection is made from the invocations known by the character. **DO NOT** select more invocations. **For Example:** After all of his selections had been made (both spell and ritual), Malcolm rolled the four six-sided dice to see how many invocations his character knows as **both** spell and ritual knowledge. A roll of "11" wasn't bad. Now Malcolm had to decide which of the magic invocations known by his character would come in handy as both spells and rituals. He decided most of the lower level invocations, which he had selected as spells, were best suited as spells (that's not necessarily true, but that was his decision). Of the five level selections of invocations from level four, which included Astral Projection, Charismatic Aura, Energy Field, Seal and Shadow Walk (all selected as spells), Malcolm decided that he wanted the *ritual knowledge* for Energy Field, Charismatic Aura and Seal. That left eight (11 - 3 = 8) other selections which his arcanist could know as both spell and ritual magic.

### Finding more magic.

Ultimately, it is the game master who controls the amount of additional magic available to the arcanist. It is the game master who must logically and sparingly work the discovery of new magic knowledge into the "story" of the adventure or campaign. New Magic will not be available every adventure. Although the magic system is designed to be quite balanced under most circumstances, the use and availability of magic will differ from game master to game master, depending on experience, the players, the story, and personal taste. If you feel a particular invocation will imbalance or hurt your game, do not make it available.

---

**Note:** Magic can not be cast from the astral plane or while in astral form, into the material world. However, two astral travelers can attack each other *in the astral plane* with magic (spell only), psychic powers or hand to hand.



# MAGIC INVOCATIONS: SPELLS AND RITUALS!

## LEVELS OF MAGIC

The magic levels have nothing to do with the experience level of the character. The magic is listed by level to indicate the invocation's *comparative* P.P.E. cost, complexity and rarity. The higher the level, the more potential psychic energy needed. The higher the level, the less common the invocation and more the difficult to find. Any arcanist can and will know a greater number of invocations, low and high level, regardless of the character's level of experience.

## INVOCATIONS: SPELLS OR RITUALS

To avoid a complicated magic system, all magic invocations/incantations can be found as both spells or rituals/ceremonies.

**Spells** are *usually* low level invocations taking the form of a chant or mantra, require minimal potential psychic energy (P.P.E.) and can be performed quickly. Two low level spells (levels one through three) can be cast per melee (15 seconds). The higher levels of magic are more complex and require more time. One spell per melee for fourth and fifth level magic. One spell every two melees (30 seconds) for levels six and seven, and two minutes (8 melees) for levels eight and higher.

**Ritual or ceremonial magic** *usually* involves an arcanist and several friends or followers participating in a magic invocation ceremony that demands great amounts of potential psychic energy. But low level invocations can also be done this way. Level one through eight invocations can be completed in 20

minutes. Levels nine, ten, eleven and twelve require a one hour ceremony. Levels thirteen, fourteen and fifteen require an hour and a half, 90 minutes. Or as many as five (5) low level invocations can be performed during a multifunction ceremony, but take 90 minutes each.

When invocations are selected or found, the player (when initially selected) or the game master (all later additions) must designate whether the invocation is a spell or a ritual/ceremony. Knowing the spell version of an invocation does not mean the mage also knows the ritual, and vice versa. However, the character can learn *both* the spell version and the ritual version(s) of the same invocation. Also, remember that there are dozens of variations of spells and, especially, rituals to invoke the same basic magic. For example: Demonic, necromantic, and other evil forms of magic, frequently require a blood sacrifice or act of evil or cruelty. But the same invocation, that is, the same magic power/effect, also exists as other, non-violent, non-wicked rituals as well. It is simply a matter of finding these rare, lost secrets of magic.

## MAGIC COMBAT

### Saving Throw

Whenever magic is used to attack or influence somebody, that person, or any living creature, automatically gets a saving throw. A *saving throw* is like a mental or magical parry to fight off/block the influence of magic. A **successful saving throw** against magic means the magic has no effect on the person. A **failed roll** to "save vs magic" means the magic has full effect on the victim. Physical magic assaults, such as cloud of smoke, energy bolt, fire bolt, objects hurled by telekinesis, call lightning, and similar attacks in which a visible, real, physical force is being used, can not be avoided by rolling a saving throw. In those instances, the saving throw does not apply. However, the physical attacks can be dodged like any physical attack. **Non-living** objects get no saving throws. **Animals** are -4 to save.

*To save against a magic attack, the player rolls a 20-sided die and must match or better the magic attack.*

*To save vs spell magic, the player must roll a 12 or higher against individuals who are of levels 1, 2, or 3 experience; 13 or higher against mages who are 4th, 5th, 6th or 7th level; 14 or higher against individuals who are 8th, 9th, 10th and 11th level; 15 or higher for mystics who are 12th, 13th, 14th or 15th level or higher.*

*To save vs ritual/ceremonial magic, the player must roll a 16 or higher. The saving throw for ritual magic is much higher than that for spell magic because of the preparation time, deep concentration, high emotion and, usually, the greater number of people participating in the ritual.*

### Cancelling Magic

The creator of the magic can cancel/stop its-effect or influence instantly at any time. Likewise, the magic-weaver does not have



N. O'Connor & S.R. Bissett



to create the magic for its full duration, but can impose any amount of time, as long as it does not exceed the maximum possible duration.

**Interrupting a spell caster**, preventing him from completing the spell, will force the mage to stop and start, again, from the beginning. But no potential psychic energy is lost. A spell caster can stop reciting a spell in mid-incantation without expending P.P.E. or causing any side effect.

**Ritual/Ceremonial magic**, although usually more powerful, is also more fragile. **An interruption of the ritual, lasting more than 30 seconds** preventing the arcanist leader from continuing, will ruin the ceremony, as well as cause 30% of the total available P.P.E. to leak away unused. **Incapacitating the leader** for over 30 seconds will have the same effect. **Incapacitating the other** participating members/cultists (rendering them unconscious, pulling them away, etc.) will only reduce the amount of available potential psychic energy. Of course, if the available P.P.E. is reduced to below the invocation's requirement, the magic can not be performed. **The negate magic** spell or ritual can also be used to cancel/stop the effects of magic.

## MAGIC TERMS AND DESCRIPTIONS

**Level of experience/spell caster** refers to the experience level of the person who is casting the magic. This is a very important distinction, particularly in a combat situation, because the higher the experience level of the spell caster, the more powerful the spell. Many invocations will indicate something like "*Duration: 5 melees per level of experience.*" or "*One die damage per level of the spell caster.*" and so on. **This means** that a *third level mage* with a spell duration of 5 melees per level of the spell caster, upon casting a spell, can maintain the spell's effects for a maximum duration of 15 melees (5 melees for each level of experience  $\times$  third level = 15 melees).

**Range:** Indicates the maximum distance the magic can be cast with: X number of feet, touch or radius (area of spell effect).

**Area affect magic** are incantations that affect everyone and/or everything in a given area or radius. A spell with a 15ft radius affects *all* within the circle of its power/radius. Those just outside the area are not affected.

**Line of vision** means that the mystic's target/victim must be within his sight (line of vision) to be affected. If the target is not seen, is totally obscured by obstacles, darkness, invisibility, or just not seen by the spell caster (hiding, behind him, beyond normal vision), the magic can not be used. However, some line of vision spells can be directed in a specific area that the spell caster can see to affect someone invisible or hidden.

**Touch** means that the magic's effects can only be transmitted through physical contact.

**Duration:** This indicates how long the magic's effects last, whether it be *instant* like a Fire Bolt or *long-lasting* like a Fly as an Eagle spell. Long-lasting magic will indicate exactly how many melees it lasts, "*per level of experience.*"

**Base magic strength/attack for spell magic** is 12.

**Base magic strength/attack for ritual magic** is 16. No bonuses apply to increase the strength of ritual magic.



Nancy O'Connor  
E.S. REISSETTE 10/87



# An Alphabetical List of Invocations by Level

*The number in parenthesis ( ) are the number of P.P.E. required to use the magic.*

## Level One

Blinding Flash (1)  
Cloud of Smoke (2)  
Death Trance (1)  
Globe of Daylight (2)  
See Aura (2)  
See the Invisible (2)  
Sense Evil (1)  
Sense Magic (2)  
Sense P.P.E. (3)  
Thunderclap (2)

## Level Two

Befuddle (3)  
Climb (3)  
Concealment (3)  
Detect Concealment (4)  
Extinguish Fire (4)  
Fear (5)  
Heavy Breathing (3)  
Levitation (4)  
Mystic Alarm (4)  
Turn Dead (4)

## Level Three

Breathe Without Air (5)  
Energy Bolt (5)  
Fingers of Wind (5)  
Float in Air (5)  
Fuel Flame (5)  
Ignite Fire (6)  
Impervious to Fire (5)  
Impression (4)  
Invisibility: Simple (6)  
Negate Poisons/Toxins (5)  
Paralysis: Lesser (5)  
Telekinesis (6)

## Level Four

Astral Projection (7)  
Blind (6)  
Charismatic Aura (7)  
Cure Minor Disorders (7)  
Energy Field (7)  
Fire Bolt (7)  
Multiple Image (7)  
Repel Animals (7)  
Seal (7)  
Shadow Meld (7)  
Swim as a Fish (6)  
Trance (7)

## Level Five

Calling (8)  
Circle of Flame (10)  
Domination (10)  
Energy Disruption (8)  
Escape (8)  
Eyes of Thoth (8)  
Fly (15)  
Heal Wounds (10)  
Horrific Illusion (10)  
Sleep (10)  
Superhuman Strength (10)  
Superhuman Speed (10)

## Level Six

Apparition (15)  
Call Lightning (15)  
Compulsion (15)  
Cure Illness (15)  
Enhanced Memory (12)  
Impervious to Energy (15)  
Mask of Deceit (15)  
Memory Bank (12)  
Teleport: Lesser (15)  
Time Slip (15)  
Tongues (12)  
Words of Truth (15)

## Level Seven

Agony (20)  
Animate/Control Dead (20)  
Constrain Being (20)  
Invisibility: Superior (20)  
Invulnerability (25)  
Life Drain (25)  
Metamorphosis: Animal (25)  
Paralysis: Superior (25)  
Purification (Food/Water) (20)  
Second Sight (20)  
Wind Rush (20)

## Level Eight

Commune with Spirits (25)  
Exorcism (30)  
Hallucination (30)  
Locate (30)  
Luck Curse (35)  
Metamorphosis: Human (35)  
Minor Curse (30)  
Negation (30)  
Oracle (30)  
Sickness (35)  
Spoil (Water/Food) (30)

## Level Nine

Curse: Phobia (40)  
Familiar Link (55)  
Metamorphosis: Insect (60)  
Protection Circle: Simple (45)  
Summon & Control Canine (50)  
Temporary Insanity (60)  
Transferral (50)

## Level Ten

Banishment (65)  
Bonding (80)  
Curse: Paranoia (70)  
Control/Enslave Entity (80)  
Metamorphosis: Superior (100)  
Summon/Control Rodents (70)  
Wards (90)

## Level Eleven

Create Mummy (160)  
Curse: Neurosis (95)  
Immure Entity (200)  
Remove Curse (140)  
Summon & Control Animals (125)  
Summon Fog (140)

## Level Twelve

Amulet (290)  
Calm Storms (200)  
Create Zombie (250)  
Metamorphosis: Mist (200)  
Summon Entity (250)  
Summon Rain (200)

## Level Thirteen

Create Golem (500 or 700)  
Protection Circle: Superior (250)  
Summon Storm (300)  
Summon Lesser Being (425)  
Sanctum (390)  
Talisman (500)

## Level Fourteen

Id Barrier (600)  
Restoration (750)  
Summon Greater Being (800)

## Level Fifteen

Dimensional Portal (1000)  
Teleport: Superior (600)  
Transformation (900)

**Note:** Remember, all of these invocations can be used as a spell or ritual; base saving throw for a spell is 12, ritual is 16.



# INVOCATION DESCRIPTIONS

## LEVEL ONE

### Blinding Flash

**Range:** 10ft (3m) radius; up to 60ft (18.3m) away.

**Duration:** Instant

**Saving Throw:** Standard

**P.P.E.:** One

This invocation creates a sudden burst of intense, white light, temporarily blinding everyone in its ten foot radius (3m). Victims are blinded for one to four melees, a penalty of -5 to strike, and -10 to parry and dodge. The chance of falling is 50% every 10ft (3m). The magic can be cast up to 60ft (18.3m) away. Saving throw is standard; those who successfully save vs magic are not blinded.

### Cloud Of Smoke

**Range:** 90ft (27.4m)

**Duration:** 4 melees per level of experience.

**Saving Throw:** None

**P.P.E.:** Two

This magic enables the arcanist to create a cloud of dense, black smoke (30ft x 30ft x 30ft maximum size) up to ninety feet away. Victims caught in the cloud will be unable to see anything beyond the cloud, and their impaired vision allows them to see no more than three feet in the cloud (and that means only a blurry shape). While in the cloud, victims will be -5 to strike, parry, and dodge.

### Death Trance

**Range:** Self

**Duration:** 10 melees (2½ minutes) per level of experience.

**Saving Throw:** None

**P.P.E.:** One

A magically induced trance which makes the mage appear to be dead. There is no breathing, pulse, heartbeat, or any other signs of life. While in the trance, the arcanist is quite helpless, unable to speak, move or invoke magic. Only minor physical sensations felt by the mage are recognizable, like being jostled, carried or hearing voices, but no specific identification or memories are possible. The magic can be canceled at will.

### Globe of Daylight

**Range:** Near self or up to 30ft (9.1m) away.

**Duration:** 12 melees (3 minutes) per level of experience.

**Saving Throw:** None

**P.P.E.:** Two

A small globe or sphere of true daylight is magically created. The light is bright enough to light up a 12ft (3.6m) area per each level of its creator's experience. Because it is daylight, it can ward off most vampires, keeping them at bay just beyond the edge of light. The creator of the globe can mentally move it along with himself, or send it up to thirty feet (9.1m) ahead. The maximum speed at which the globe can travel is equal to a speed attribute of 12.

### See Aura

**Range:** 100ft (30.5m)

**Duration:** 1 melee

**Saving Throw:** None; but a psychic mind block will mask the presence of psychic abilities, the level of P.P.E., and possession.

**P.P.E.:** Two

All things, organic and inorganic, have an aura. The aura has many distinctions, and can be used to see or sense things invisible to the eye. *Seeing an aura will indicate the following:*

- Estimate the general level of experience. Low (1-3), medium (4-7), high (8th and up).
- The presence of magic (no indication of what, or power level).
- The presence of psychic abilities.
- High or low base P.P.E.
- The presence of a possessing entity.
- The presence of an unusual human aberration, which indicates a serious illness, non-human, or mutant, but does not specify which.

**Note:** Can not tell one's alignment from "see aura".

### See the Invisible

**Range:** 200ft (91m) vision, self or others by ritual.

**Duration:** 1 minute (4 melees) per each level of experience.

**Saving Throw:** None

**P.P.E.:** Two

The character can see forces, objects and creatures which can turn invisible or are naturally invisible. Even if the creature has no form per se, the mystic will be able to discern the vaporous image or energy sphere which is the being. This includes: ghosts, entities and the astral body.

### Sense Evil

**Range:** 90ft (27.4m) area

**Duration:** 2 minutes (8 melees) per level of experience.

**Saving Throw:** None, except a psychic mind block, or a protection from magic pentacle which will prevent the spell from working on anyone in the circle. The psychic's equivalent power of sense evil is not blocked by the magic pentacle.

**P.P.E.:** One

The sense evil invocation will enable its spell caster to feel or sense the presence of *supernatural evil*. It will indicate approximately how many supernatural evil presences are within the 90ft (27.4m) area; one, a few (2-6), several (7-14), or many (15 or more). It can also register the intensity of the evil and pinpoint the general location of the source(s) to a particular room(s), possessed object, or person, or an approximate distance (very close, near, far, etc.).

Evil emanations from human beings are much less distinct and can not be sensed unless the source/person has an immediate evil intention.

### Sense Magic

**Range:** 120ft (36m) area; self only.

**Duration:** 2 minutes (8 melees) per level of experience.

**Saving Throw:** None

**P.P.E.:** Two

This magic ability enables the character to sense or feel the presence of magic. Like a Geiger counter, the individual can



tell if he is near (within 20ft) or far (toward the limit of the range). The ability can also indicate whether a person or object is enchanted/under a magic spell (this does not include psychic powers), is in the process of invoking magic, or if magic is being used in the range area. **Note:** Arcanists and most supernatural beings do not register as magic except when actually casting a spell/using magic.

## Sense P.P.E.

**Range:** 120ft (36m) area

**Duration:** 1 minute (4 melees) per level of experience.

**Saving Throw:** Standard; ley lines and inanimate objects have no saving throw.

**P.P.E.:** Three

This mystic invocation allows the invoker to sense the presence of potential psychic energy (P.P.E.) within a 120ft (36m) area. Like a Geiger counter, the individual can tell if he is near (within 20ft/6.1m) or far (at the limit of the magic's range). This magic ability should not be confused with "sense magic." It can NOT pickup *magic* emanations, so it will not identify most magic objects, enchantment or spell casting. What this magic does provide is an indication of potential psychic energy within the area — people, places, supernatural beings, animals and other sources of P.P.E. This can be important if there is a need to draw additional P.P.E. from another source(s). **First**, the magic will alert the mage to the presence of potential psychic energy in its range area. **Second**, the arcanist can determine the approximate amount of P.P.E. each individual currently possesses. Little is 1-5 P.P.E., typical is 6-15, medium is 16-30, a lot is 31-60, vast (and often unnatural) is 61 and higher, incredible is 500 P.P.E. or higher. Objects only register potential psychic energy if they are possessed/inhabited by a living force.

## Thunderclap

**Range:** Directly affects the immediate area (30ft/9.1m around the magic weaver), but can be heard up to one mile away.

**Duration:** Instant

**Saving Throw:** Save vs Horror Factor

**P.P.E.:** Two

The invocation produces a booming clap of thunder that is so loud that it seems to make the air vibrate. A thunderclap is an excellent means of alerting or signaling allies, as well as a means of intimidation. As an intimidation device, it will momentarily startle and distract everyone other than the spell caster. This provides the creator of the thunder with a bonus of +5 on his initiative, +1 to strike, parry and dodge, and creates a horror factor of 8 (all characters within 30ft/9.1m must roll to save vs horror factor, except the mage who made the thunder).

## LEVEL TWO

### Befuddle

**Range:** 100ft (30.5m)

**Duration:** 2 minutes (8 melees) per level of experience.

**Saving Throw:** Standard

**P.P.E.:** Three

An enchantment that temporarily causes its victim to become confused and disoriented. Concentration and reactions are im-

paired. Those affected are -2 to strike, parry and dodge; attacks per melee are reduced by one-half and all skills suffer a penalty of -20%. Each invocation affects only one person each time it is cast. A successful save vs magic means the intended victim suffers no impairment.

### Climb

**Range:** Self, or others up to 40ft away (12.2m).

**Duration:** 5 minutes (20 melees) per level of experience.

**Saving Throw:** None

**P.P.E.:** Three

An enchantment that enables the enchanted person to climb with exceptional, almost inhuman, skill, speed and agility. Skill level is 98% for *normal*, rough, climbable surfaces; speed is equal to speed attribute. Smooth, presumably unclimbable or extremely difficult surfaces to climb normally can be scaled with a skill level of 60%. Rappelling is included.

### Concealment

**Range:** Small objects up to 40ft away (12.2m).

**Duration:** 5 minutes per level of experience.

**Saving Throw:** Standard

**P.P.E.:** Three

This magic makes any small object sort of invisible. Actually, it affects the perception of anybody who looks at it. Unless the person(s) makes a successful saving throw, the item can not be seen. This can be applied to an item on one's person or out in the open. Only one object is affected each time the magic is invoked. The object can not be living and must be smaller than 14 inches in length and height 6 inches in width, and weigh 14 pounds (6.4kg) or less. Each person who looks at the place where the enchanted object is resting must roll a saving throw versus magic. A failed roll means that particular individual will not see it until the magic lapses. **Note:** If the object is used as a weapon or picked up by the mystic or anyone who does see it, the enchantment is broken and it becomes clearly visible to all.

### Detect Concealment

**Range:** Area affect: 30ft (9.1m).

**Duration:** Instant

**Saving Throw:** None

**P.P.E.:** Four

A magic invocation that will instantly negate any concealment spell(s) and reveal any object(s) which may have been mystically concealed. Can be directed at a specific area or individual, or made to affect an entire area of 30ft (9.1m). Only the spell caster can see through the concealment.

### Extinguish Fire

**Range:** 20ft (6.1m) area, up to 80ft away.

**Duration:** 1 minute (4 melees) per level of experience.

**Saving Throw:** None

**P.P.E.:** Four

The mystic can instantly put out up to a 20ft (6.1m) area of fire 80ft away (24.4m). A total of 40ft (12.2m) can be extinguished every 15 seconds (one melee).



## Fear (Horror Factor: 16)

**Range:** 20ft (6.1m) area, up to 100ft away (30.5m).

**Duration:** 1 minute (4 melees) per level of experience.

**Saving Throw:** Special; Save vs Horror Factor

**P.P.E.:** Five

The invocation creates a sensation of fear over a particular area (20ft maximum area of affect). The mystic can place the enchantment on an area occupied with people, or an area that is not presently occupied. Anybody entering the area of enchantment must roll to save vs horror factor 16. A failed roll means the person is suddenly washed with terror and will be momentarily stunned, loses initiative, is the last person to attack, and can not defend against an opponent's first strike each melee the person is in the area of fear. Also see "the Horror Factor" explanation in the combat section of the book.

## Heavy Breathing

**Range:** 60ft

**Duration:** 5 melees per level of experience.

**Saving Throw:** Standard

**P.P.E.:** Three

The mage is able to conjure a mysterious, frightful sound of heavy, labored breathing, as if something invisible was lurking about. The mage can mentally manipulate the sound, increasing or decreasing the breathing rhythm, and move the sound around up to 60ft away. The breathing can be heard in a six foot radius. Those hearing the breathing will become fearful and panicky. There is a 60% chance that the frightened fellow will flee in terror. Those who hear the breathing, but do not run, will be -2 to strike, and -1 to parry and dodge as they shake in their boots.

*Saving Throw:* Standard; those who save are not affected/fearful.

## Levitation

**Range:** Up to 60ft (18.3m) away.

**Duration:** 3 minutes (12 melees) per level of experience.

**Saving Throw:** Standard

**P.P.E.:** Four

Magic levitation enables the invoker of the magic to raise himself, or other people, or an object, straight up into the air and suspend it there (hover). Movement is limited to straight up and down; no horizontal motion is possible. Weight is restricted to 200lbs (90kg) plus 20lbs (9.1kg) per level of experience. Unwilling victims of the magic get a saving throw; a successful roll means the person is *not* affected by the levitation and remains planted firmly on the ground. Maximum height possible is 60ft (18.3m) plus 10ft (3m) per each level of experience. Targets can be affected up to 60ft (18.3m) away.

## Mystic Alarm

**Range:** 12ft (one object)

**Duration:** One year per level of experience.

**Saving Throw:** None

**P.P.E.:** Four

The arcanist can protect his possessions and domicile by placing mystic alarms on them. The invocation creates invisible, ward-like symbols on any *one*, specific, non-living object. If

this object is touched or disturbed by anyone other than the spell caster, a silent alarm will buzz in the mage's head, alerting him to the intrusion. The alarm will alert him instantly, even if he is thousands of miles away or in another dimension. Once disturbed, the alarms disappear. The mystic alarm has a limited life of one year per level of arcanist.

## Turn Dead

**Range:** Up to 60ft (18.3m) away

**Duration:** Instant effect.

**Saving Throw:** Standard

**P.P.E.:** Four

The utterance of this arcane magic will turn/repel 1 to 6 animated dead per level of experience. This means that those creatures affected will turn and immediately leave the area without harming the spell caster or anyone near him. The dead turned will not come back for 24 hours. This magic only affects "animated" dead, and skeletons or corpses that are magically animated like marionettes, but will *not* affect vampires, zombies, or any corpse or skeleton possessed by a living entity.

## LEVEL THREE

### Breathe Without Air

**Range:** Self or others by touch.

**Duration:** 12 melees (3 minutes) per level of experience.

**Saving Throw:** None

**P.P.E.:** Five

This invocation enables the person to function normally without air, whether it be underwater or in a vacuum, or in an area with little or no oxygen. Unfortunately, the magic does *not* protect the person from magic toxins or other types of magic, but *does* protect against natural and man-made gases.

### Energy Bolt

**Range:** 150ft (45.7m)

**Duration:** Instantly

**Damage:** 4D6

**Saving Throw:** Dodge of an 18 or higher.

**P.P.E.:** Five

The incantation creates an energy bolt that the mage can mentally direct by simply looking at his intended target. The bolt may appear to fire from a hand or finger or the eyes, but needs *no* physical gesture, such as pointing. Damage is normally four six-sided dice (4D6), but is increased to 6D6 under the influence of a *ley line* and 8D6 at a *ley line nexus*; P.P.E. cost is still only five despite the increased damage capability. *One* energy bolt can be fired at one target per each spell invocation.

### Fingers of the Wind

**Range:** 90ft

**Duration:** 3 melees per level of experience.

**Saving Throw:** None

**P.P.E.:** 5

The magician can conjure a wind and manipulate it to touch, tap, bump, or press against a person or object. It can also put out candles, slam doors shut, or move or knock over small items weighing less than 10 pounds.



## Float in Air

**Range:** Self or others within 30ft.

**Duration:** 10 melees per level of experience.

**Saving Throw:** None

**P.P.E.:** Five

This spell creates air currents which hold a person or object aloft, hovering about one foot above the ground. It can be used to slow someone's descent from a fall or used to float on top of water. Movement is awkward and slow while in the air. The floating person suffers the following penalties: All attacks, strikes, parries and dodges are at -1; normal speed/movement is reduced to half.

## Fuel Flame

**Range:** 100ft (30.5m)

**Duration:** Instant

**Saving Throw:** None

**P.P.E.:** Five

The magic feeds any existing fire, doubling it in size. It can affect a 10ft area (30.5m) up to 100ft away.

## Ignite Fire

**Range:** 40ft (12.2m)

**Duration:** Instant (counts only as one attack; fire lasts until it is put out).

**Saving Throw:** None

**P.P.E.:** Six

A magic that is similar to the pyrokinetic ability called spontaneous combustion, but is a little more potent. The magic will ignite any material that can burn. This means the mystic could set a chair on fire, a jacket, hair, and so on. **Note:** Volatile substances that are *contained in something*, like gasoline in the gas tank of a car, can NOT be ignited. The target to be set on fire must be clearly *visible*. Maximum area of affect is 3ft (0.9m). If somebody's clothes or hair are set on fire, they have two melees (30 seconds) to get it off or put the fire out before damage is inflicted; no other combat or action is possible. Damage from the small fire is 2D6 per melee (beginning after the first 2 melees).

## Impervious to Fire

**Range:** Self or others up to 60ft (18.3m) away.

**Duration:** 5 minutes (20 melees) per level of experience.

**Saving Throw:** None

**P.P.E.:** Five

A magic invocation that makes the individual temporarily impervious to fire. Normal and magical fires do no damage to the person or to anything he is wearing/on his person.

## Impervious to Poison

**Range:** Self or others by touch.

**Duration:** 5 minutes (20 melees) per level of experience.

**Saving Throw:** None

**P.P.E.:** Five

This enchantment makes the person temporarily impervious to poisons, deadly toxins and poison gases.

## Impression

**Range:** Touch

**Duration:** One melee (15 seconds).

**Saving Throw:** None

**P.P.E.:** Five

The mystic is magically instilled with the ability to receive psychic impressions from an object about its *previous owner*. The following information will be revealed.

1. General alignment; good, selfish, or evil.
2. Human or not human (specific nature of the inhumanness not revealed).
3. Old or young.
4. Male or female.
5. Healthy or sick or hurt.
6. Whether the object is important or valuable to the individual, although the reason why is not revealed.

## Invisibility: Simple

**Range:** Self only (includes clothes and articles on one's person).

**Duration:** 3 minutes (12 melees) per level of experience.

**Saving Throw:** None

**P.P.E.:** Five

The arcanist and anything he is wearing or carrying at the time of the invocation are turned completely invisible. Any object picked up after the character has become invisible remains visible. Likewise, any item on his person that is dropped becomes visible. Neither normal nor nightvision can detect invisibility; only beings who can naturally, psychically or magically "see the invisible" are able to see an invisible person. Infrared and heat detectors can also pinpoint an invisible person.

Although the invisible person is imperceptible to the eye, he still retains physical mass. This means he can not go through walls nor can weapons pass harmlessly through him. The character still makes noise, leaves footprints, and physical and magical contacts/attacks still affect him as usual.

While invisible, the mage can talk, weave spells, walk, climb, run, open doors, carry objects, and perform other acts of physical exertion, including combat, and remain invisible. The invisibility is terminated when the magic's duration time elapses or the mage cancels the spell. **Note:** If cut, only the blood is visible.

## Negate Poison/Toxin

**Range:** Self or by touch.

**Duration:** Instant

**Saving Throw:** None

**P.P.E.:** Five

The arcanist can magically turn a poisonous substance inert, rendering it harmless. The magic can also be used to instantly negate poison in the bloodstream preventing further damage by the foul substance. However, any damage caused by the poison before the magic is used can not be reversed.



## Paralysis: Simple

**Range:** 60ft (18.3m)

**Duration:** The effect lasts one minute (4 melees) per level of experience.

**Saving Throw:** Standard

**P.P.E.:** Five

This magic attack temporarily paralyzes a part of its victim's body; immobilizing that particular limb. A paralyzed hand means that the person can not pick up or hold objects or write, or use the hand in any way. A paralyzed arm means the limb dangles uselessly at the person's side. A paralyzed leg will make standing difficult and movement almost impossible; reduce speed by 90%, -2 to parry and dodge. **Note:** The incantation will paralyze only one limb per each invoking of the magic. Internal organs can *not* be affected, so the mage can not paralyze a heart or lung, etc.

## Telekinesis

**Range:** 60ft (18.3m)

**Duration:** 1 minute (4 melees) per level of experience.

**Saving Throw:** Dodge

**P.P.E.:** Six

The telekinesis invocation temporarily empowers the arcanist with the psychic ability to move objects with thought. This power can be used to move or hurl objects, bring them to him, open doors, flick switches, press buttons, and so on.

### Rules and Limitations:

- Maximum Total Weight: 60 pounds (27kg).
- Attacks Per Melee: Equal to the number of hand to hand attacks per melee that the character may have.
- Bonuses to Strike: +3 with telekinesis; physical and skill bonuses to strike do not apply when telekinesis is used.
- Bonuses to Parry: +4; physical and skill bonuses to parry do not apply to telekinesis.
- Damage from Hurling Objects:
  - Small: 6 ounces (0.2kg) to 1lb (0.45kg) — 1D4
  - Small: 1½ to 2½lbs — 1D6
  - Medium: 3 to 4½lbs — 2D4
  - Medium: 5 to 10lbs — 3D4
  - Large: 11 to 25lbs — 3D6
  - Large & Heavy: 26 to 60lbs — 4D6Add 1D6 for each additional 20lbs of weight.
- Object being manipulated must be visible.
- Telekinesis can be combined with hand to hand combat, but does *not* add extra attacks per melee.
- Influence from ley line energy doubles the amount of weight and range possible.
- Ley line nexus energy triples the amount of weight and range.

## LEVEL FOUR

### Astral Projection

**Range:** Self

**Duration:** 5 minutes per level of experience.

**Saving Throw:** None

**P.P.E.:** Seven

The incantation sends the spell caster's astral body into the

astral plane, another dimension. This magic functions exactly like the psychic sensitive ability of the same name.

## Blind

**Range:** Touch or 10ft (3m) away.

**Duration:** 1 minute per level of experience.

**Saving Throw:** Standard

**P.P.E.:** Six

An enchantment that can blind one person or animal each time the spell is cast. The intended victim must be visible and within range. The victim will be temporarily blind; -5 to strike, -10 to parry and dodge, and likely to stumble and fall for every 10ft (3m) of movement (50% chance).

## Charismatic Aura

**Range:** 60ft radius

**Duration:** 6 melees per level of experience.

**Saving Throw:** Standard

**P.P.E.:** Seven

A particularly handsome tool of deception, this magic can be cast upon the spell caster or another person. The spell instantly enhances that person's physical beauty by eight (8), increasing his charisma and charming all who behold him. Although the focal point of the spell is the person on whom it was cast, it affects everybody in a 60 foot radius (emanating from the person with the charismatic aura). Thus, *everybody* in that radius is allowed a saving throw vs magic. Those who successfully save will not be affected at all; those who fail to save are affected and will respond accordingly.

The person with a charismatic aura can invoke one of three responses: *friendship/trust*, *power/fear*, and *successful deception*.

**Friendship/Trust:** The first few words spoken will set up the response. Thus, a statement of friendship, peace, or trust will inspire those sentiments in everyone affected.

**Power/Fear:** A statement of power, anger, strength, or vile intent, will strike awe and fear into everyone affected. (Example: "Lay down your weapons and let us pass, lest you suffer my wrath!"). **Horror Factor:** 13.

**Successful Deception:** This enables the charismatic aura person to *convincingly lie* like a master con-man. There is an 80% chance that those affected will believe anything he tells them. This response is triggered by a phrase like: "Trust me completely . . ." or "I would never lie to you."

## Cure Minor Disorders

**Range:** Touch or 10ft (3m).

**Duration:** Instant

**Saving Throw:** Standard (if unwanted)

**P.P.E.:** Seven

A unique bit of curative magic that will instantly relieve *minor* physical disorders and illness, such as headaches, indigestion, gas, heartburn, nausea, hiccups, muscle stiffness, low fever (under 101 degrees) and similar. This invocation will also negate simple curses that inflict minor disorders.

## Energy Field

**Range:** Self or others up to 60ft (18.3m) distance.



**Duration:** One minute (4 melees) per level of experience or until it is destroyed.

**Saving Throw:** None

**P.P.E.:** Seven

The magic creates a protective field of energy around the mystic, others, or an object. The maximum area of protection is about 8ft (2.4m), which means it can protect a small roomful of people (about 6 to 8 individuals). The energy field appears as a semitransparent wall or bubble that shimmers with a blue-white light. The field normally provides a total protection of 60 S.D.C., but is doubled at ley lines and tripled at ley line nexuses. Armor Rating is 4.

## Fire Bolt

**Range:** 100ft (30.5m) plus 5ft (1.5m) per level of experience.

**Duration:** Instant

**Damage:** 6D6

**Saving Throw:** Dodge

**P.P.E.:** Seven

Like the energy bolt, the mage can create and direct a bolt of fire. Bonus to strike is +4. **Damage** is normally 6D6, but increases to 8D6 at ley lines and to 1D6 × 10 at a ley line nexus.

## Multiple Image

**Range:** Self

**Duration:** One minute (4 melees) per level of experience.

**Saving Throw:** Special penalty of -4 to save.

**P.P.E.:** Seven

An illusion that creates three identical images of the mage which mimic his every movement exactly. Only piercing the false image with iron will dispel that particular image. This is a great way to confuse, scare and distract an opponent(s). Provides the mage with a bonus of +2 on initiative, +2 to dodge, +1 to strike.

*Saving Throw:* Viewers may be able to see through the illusion and identify the true person, but such rolls vs magic are at a minus six (-6).

## Repel Animals

**Range:** 30ft (9.1m)

**Duration:** Immediate

**Saving Throw:** Standard for animals.

**P.P.E.:** Seven

The character can invoke an enchantment that will make even a hostile predatory animal stop, turn, and leave the area without harming the mage or anybody near him. The animal will not return for hours. The enchantment can affect six animals simultaneously.

## Seal

**Range:** 100ft (30.5m)

**Duration:** Two minutes (8 melees) per level of experience.

**Saving Throw:** None

**P.P.E.:** Seven

The mage can magically prevent any inanimate object from being opened. The mystic can seal shut a door, gate, window, drawer, lid, and so on. There is no sign of force, the lock can be unlatched, but the door, or whatever, will not yield/open

regardless of the character's physical strength. The only way to get in or out or open is to smash or chop through the obstacle.

At early levels, the mystic can only seal one item per incantation. However, at fourth level of experience and beyond, the arcanist can seal every door, window and enclosure within an 100ft area (that can be an entire 50 to 80 foot house up to 3 stories high).

## Shadow Meld

**Range:** Self

**Duration:** Two minutes (8 melees) per level of experience.

**Saving Throw:** None

**P.P.E.:** Seven

This unique magic enables the mage to step into shadows, becoming totally invisible, even to a "see the invisible" spell. The shadow must be at least five feet tall to become an effective hiding place. The shadow serves as a superior means of hiding or moving unseen. The mage can move, walk, or run through the length of shadow or from shadow to shadow. While in shadow/darkness, the mage prowls at a 60% proficiency (or at +15% to normal skill, whichever is higher).

Intense light will dispel the shadow, leaving the mage revealed. Of course, sanctuary can be found by fleeing into another shadow. Feeble light, less than 10 torches or 300 watts, will only create more shadows.

While hidden in shadow, the character is still susceptible to magic, psychic and physical attacks, although attackers are -5 to strike him (because they can not see him). Area affect magic does not suffer any penalty. *Infrared* optics are the only means that can be used to see somebody in a shadow.

## Swim as a Fish

**Range:** Self or others up to 10ft away.

**Duration:** 5 minutes (20 melees) per level of experience.

**Saving Throw:** None

**P.P.E.:** Six

An incantation that provides the character with exceptional swimming abilities. Equal to Advanced Swimming and S.C.U.B.A. skills combined: Base Skill is 96%, can swim a distance of 100 × P.S. in yards/meters without tiring, additional +1 to parry and dodge while in water, and can hold breath for two minutes at a time.

## Trance

**Range:** Touch or within 12ft (3.6m).

**Duration:** 5 minutes per level of experience.

**Saving Throw:** Standard

**P.P.E.:** Seven

This enchantment places another person into a zombie-like state in which the entranced person is in a hypnotic daze, unaware of his environment or happenings around him. He can not formulate thoughts, use skills, or act on his own. While entranced, the individual is only aware of the enchanter's voice and will follow extremely simple commands, such as stay, sit, follow me, get inside, lay down, give me your hand, etc. The entranced victim can NOT engage in any type of combat to any degree, nor any actions that require skill or thought, and offers no resistance. The magic is meant to incapacitate more than it is to



enslave. Evil men of magic often use trance on prisoners or intended victims of a human sacrifice.

While entranced, the person can *not* be made to reveal secrets, betray a friend, harm himself, or act against his alignment. All physical attributes function as if they are half of what they really are; thus, a speed of 10 is 5 while entranced. The victim of a trance will remember nothing of the events that occurred while entranced.

## LEVEL FIVE

### Calling

**Range:** 2 miles (3.2km) per level of experience.

**Duration:** 5 minutes per level of experience.

**Saving Throw:** Standard

**P.P.E.:** Eight

The calling is like a limited form of telepathic communication in which the arcanist can mentally call a specific individual. To use "the call," the mystic must know the person's whole name (first and last), must have personally met the individual (even if only briefly) and must be within range. The call sends a telepathic message to that particular person, calling him or her by full name, and leaves an impression of where the mage can be found. A typical call message will be something like "Erick Wujcik, come to me." or "Richard Burke, I need you." Only the individual to whom the call is made can hear it, no one else. If a successful saving throw is made, the call, and impression of location, is heard only once. If the saving throw is not successful the call will repeat itself over and over again, three times per melee, until the spell elapses or the person goes to the mage. Nothing except a mind block can block out the call. A failed roll means the call keeps coming and coming, compelling the person to answer it.

### Circle of Flame

**Range:** 10ft around self.

**Duration:** 2 minutes (8 melees) per level of experience.

**Saving Throw:** None

**P.P.E.:** Ten

The mystic can create a circle of flame around himself. No combustible material is required. The flame is five feet tall and inflicts 4D6 damage to anybody who tries to pass through the fire.

### Domination

**Range:** Touch or within 4ft (1.2m).

**Duration:** 15 minutes per level of experience.

**Saving Throw:** Standard

**P.P.E.:** Ten

Domination is another trance-like enchantment that enables the mystic to impose his will over his victim's, forcing the person to do his bidding. The victim of domination will appear to be acting oddly, dazed, confused, slow and unfriendly (ignoring friends, etc.). The enchanted person has one goal, to fulfill the command of the mage. Under the enchantment of domination, the character's alignment does Not apply. He will steal, lie, assist in crimes, kidnap, betray friends, reveal secrets and so on. The victim is under (almost) complete control of the spell caster. The only things the bewitched individual will *not* do are

commit suicide, inflict self-harm, or kill a friend or loved one. A good aligned character, principled, scrupulous and even unprincipled, can not be made to kill anybody; it is too deeply against their alignment.

The enchanted person is not himself and suffers the following *penalties*. Attacks per melee are half, speed is half, all skills are half their usual proficiency, speech is slow, and the person seems distracted or a little dazed.

A successful saving throw versus magic means the magic has no effect. The person is 100% his normal self. The effects of the domination magic can *not* be faked.

### Energy Disruption

**Range:** 60ft (18.3m)

**Duration:** 3 minutes (12 melees) per level of experience.

**Saving Throw:** None

**P.P.E.:** Eight

A particularly useful magic in this modern era. The invocation will temporarily knockout, stop, or immobilize, any electrical device it is aimed at. This includes automobiles, computers, surveillance cameras, sensors, appliances, entire fuse boxes, batteries, electric alarm systems, etc. The apparatus is not harmed in any way, it simply ceases to function. When the magic elapses, the item(s) will work perfectly, with no sign of malfunction or energy loss.

At low level the arcanist can only affect one particular item per each invocation. However, at *fourth level* the mage can affect all sources of electricity within a 40ft (12.2m) area, and the range for a canceling one specific device is doubled.

### Escape

**Range:** Self, touch or 5ft (1.5m).

**Duration:** Instant

**Saving Throw:** None

**P.P.E.:** Eight

The escape invocation enables the mage to magically escape any bonds, or open any locking mechanism that bars his way. This includes being tied with rope, handcuffs, prison cells, doors, trunks, locks, straightjackets, etc. One restraint or lock can be undone per each invocation (one per melee is possible). Only gagging the arcanist will prevent the use of this magic.

### Eyes of Thoth

**Range:** Self or others by touch.

**Duration:** 10 minutes per level of experience.

**Saving Throw:** None

**P.P.E.:** Eight

Thoth is the god of knowledge and wisdom of the ancient Egyptians and said to know all languages. This invocation enables the character to read and understand ALL written languages, modern and ancient. However, the spoken languages are incomprehensible unless a tongues spell is also invoked or the person has an education in that language.

### Fly

**Range:** Object by touch.

**Duration:** 6 minutes per level of experience.



**Saving Throw:** None

**P.P.E.:** Fifteen

The arcanist can magically bestow the power of flight only to an inanimate object not made of *metal or plastic*. He or she can then use that object to fly. This is the origin of the myths about the witch and her broom and of flying carpets. The object must be big enough to hold onto or, preferably, large enough to sit on. If the item is small, the mage must hold on for dear life, and if his grip should give way, he will fall to his doom. To avoid muscle strain and tragedy, it is best that the object can be comfortably sat upon. The maximum length and width of the enchanted item must not exceed six feet (1.8m). This maximum size is enough to accommodate three additional adult passengers or six children. **Note:** The magic will not work if the object has any metal or plastic on it, including nails.

Maximum altitude is 1000ft (305m). Maximum speed is 35mph (56kmph); the object can be made to hover stationary.

## Heal Wounds

**Range:** Touch or 3ft (0.9m) distance.

**Duration:** Instant

**Saving Throw:** Standard, if the person resists the magic.

**P.P.E.:** Ten

This powerful invocation will instantly heal minor physical wounds, such as bruises, cuts, gashes, bullet wounds, burned flesh and pulled muscles. It will *not* help against illness, internal damage to organs or nerves, broken bones or poisons/drugs.

In the case of bullet wounds, the bullet should be removed first. If the bullet is left inside a person it will be a constant irritant causing chronic pain; reduce the character's P.E. attribute by one and P.P. attribute by one due to stiffness and discomfort.

The heal wound magic restores 3D6 S.D.C. and 1D6 hit points.

## Horrific Illusion

**Range:** 30ft (9.1m)

**Duration:** 2 minutes (8 melees) per level of experience.

**Saving Throw:** Save vs Horror Factor 14.

**P.P.E.:** Ten

The arcanist creates a frightening, illusionary image of a horrible sight using common images, such as a hundred large (presumably poisonous) spiders or other bugs or snakes, or a vicious, rabid animal(s), or fire, and similar. Everybody who sees the illusion must roll to save vs horror factor: 14. A failed roll means that the character is momentarily stunned, with the usual horror factor combat penalties applicable for that one melee. However, the illusion is so real that any character who fails to save will not go past the illusion, but can try to find another route around it.

## Sleep

**Range:** Touch or 1ft (0.3m).

**Duration:** Becomes inert within 15 minutes; affects last 10 minutes per level of experience.

**Saving Throw:** Standard

**P.P.E.:** Ten

The invocation can turn any normal, drinkable fluid or food into a sleep inducing potion. Immediately after two bites of enchanted food or two gulps of fluid, the person will fall into

an enchanted sleep. The victim can not be awakened by any means except by the arcanist canceling the magic or until the magic's duration time lapses. A successful save means the enchanted food or drink has no effect.

## Superhuman Strength

**Range:** Self or others by touch.

**Duration:** 2 melees per level of experience.

**Saving Throw:** None

**P.P.E.:** Ten

The incantation magically increases the character's physical strength (P.S.) to 30 and physical endurance (P.E.) to 24 and adds 30 S.D.C. for the duration of the magic.

## Superhuman Speed

**Range:** Self or others by touch.

**Duration:** 1 minute per level of experience.

**Savings Throw:** None

**P.P.E.:** Ten

The invocation bestows the character with the incredible speed attribute of 44 (equal to 30mph) and adds a bonus of +2 to parry and +6 to dodge for the duration of the magic. All movements performed during this period are done without fatigue.

## LEVEL SIX

### Apparition

**Range:** 30ft (9.1m)

**Duration:** One minute (4 melees) per level of experience.

**Saving Throw:** Standard

**P.P.E.:** Fifteen





The arcanist can create a realistic apparition in the form of a horrible creature or weird thing that will attack anybody who comes within 20ft of it. Apparitions are commonly used to block passages and guard entrances. Although an illusion, it will appear completely real, interacting with an opponent's actions. The illusion will appear to sweat and bleed, but can not be killed or stopped. The illusion can appear as any known supernatural creature or an imaginary "thing," like a man-eating refrigerator and so on.

There are only three ways to destroy the illusion: **1)** A successful save vs magic will cause the thing to disappear (at least for that individual). *Each* character must make a saving throw. **2)** Plunge a rod or something made of *iron* into it. **3)** Wait for the magic's duration time to elapse.

The person who sees the apparition will believe it to be real in every way and will even imagine it inflicting damage to him. Combat should be conducted as usual, although the damage is imaginary and disappears when the apparition is destroyed. However, the character will believe and react to it, and combat it, as if it were real. Should the opponent of the apparition die (or so he believes), he will fall unconscious for 2D4 minutes from shock. The experience is traumatic; roll to save vs insanity (a 12 or higher saves). If the roll is a failure, roll percentile dice on the *Random Insanity Table*. **Note:** No physical damage is actually sustained.

The creature will always have at least 3 attacks per melee, but no more than 6; +2 to strike, +3 to parry, +6 to dodge, incredibly strong and has a horror factor of 10.

## Call Lightning

**Range:** 300ft (91m)  
**Duration:** One melee  
**Damage:** 6D6+6  
**Saving Throw:** Dodge  
**P.P.E.:** Fifteen

The arcanist can call forth up to three lightning bolts, each doing 6D6+6 damage, within one melee (15 seconds). A roll to strike must be made for each lightning bolt; +3 to strike. If the mage desires, he can call down less than three, but not more than three, and can not wait until the next melee to use them. All three lightning bolts must be used within one melee round. Range is doubled and add 2D6 damage when at a ley line nexus.

## Compulsion

**Range:** 60ft (18.3m) and within line of vision.  
**Duration:** 24 hours  
**Saving Throw:** Standard  
**P.P.E.:** Twenty

The mystic can implant a sudden desire or need in another person's mind. The focus of the irresistible impulse should be something reasonable and attainable, although the motive may seem quite irrational. The enchanted person will be consumed with the object or action of the implanted compulsion, whether it be something very simple, like a craving for a candy bar, or the need to visit somebody or something more extravagant. The victim of this enchantment will be obsessed with attaining whatever it is for the full duration time of the incantation or until it is attained. A "remove curse" will also negate the compulsion.

## Cure Illness

**Range:** Touch or 3ft (0.9m).  
**Duration:** Instant cure  
**Saving Throw:** None; standard if the person resists treatment.  
**P.P.E.:** Fifteen

A potent magic that can cure ordinary disease and illness, such as fever, flu, and other common diseases. The magic can *not* cure cancer, lung disease, wounds, broken bones or internal damage to organs. Nor can it cure magically induced sicknesses or disorders.

## Enhanced Memory

**Range:** Self  
**Duration:** 10 minutes per level of experience.  
**Saving Throw:** None  
**P.P.E.:** Twelve

This magic enables the mage to remember events which he has experienced, or witnessed, or items read vividly. Adds a +10% skill bonus applicable to all skills, and adds to reading speed (doubles it), for the duration of the magic.

## Impervious to Energy

**Range:** Self or others by ritual.  
**Duration:** 2 minutes (8 melees) per level of experience.  
**Saving Throw:** None  
**P.P.E.:** Fifteen

The arcanist can make himself impervious to all forms of energy including fire, heat, electricity, lasers and so on. Energy attacks do no damage whatsoever. Physical attacks, guns, knives, clubs etc., do normal damage.

## Mask of Deceit

**Range:** Self  
**Duration:** 10 minutes per level of experience.  
**Saving Throw:** Standard  
**P.P.E.:** Fifteen

A useful tool for deception, it magically creates an illusionary mask over the person's own facial features. Age, gender, skin color, hair, hair length, and specific features are composed with thought. However, the magic is limited to facial features and does not apply to any other part of the body. The mage can attempt to imitate a specific person's face, but has a mere 20%+5% per level of experience skill level; if the character has the disguise skill, use that base skill instead. **Saving Throw:** Everyone encountering the person gets a save vs magic, but is -4 to succeed. A successful save means the features are seen not the mask.

## Memory Bank

**Range:** Touch  
**Duration:** 3 months per level of experience.  
**Saving Throw:** None if willing; standard if unwilling.  
**P.P.E.:** Twelve

The mage can implant a block of memory/information deep into another person's subconscious mind without them ever knowing what it is. The mage can then retrieve it at any time



with a mere touch. This technique can be used to safely record and hide phone numbers, addresses, incantations, or any other data under 1000 words. The information can be stored for three months per level of the enchanter. **Note:** A mind block will make it impossible to implant or retrieve a memory bank. There is no limit to the number of memory banks a mage can implant in the same person. The memory will fade away after the magic's duration time has elapsed.

## Teleport: Lesser

**Range:** Five miles (8km) per level of experience; touch.  
**Duration:** Requires two full melees (30 seconds).  
**Saving Throw:** None  
**P.P.E.:** Fifteen

The power to transmit matter from one place to another. The lesser teleport invocation is limited to non-living substances. Up to 50lbs (22kg) can be instantly transported from the location of the spell weaver to any location miles away. The only requirements are that the arcanist *touches* the object to be teleported and that the location of where it is being sent to is *known* by the arcanist. Success Ratio: 80% + 2% per level of the arcanist. An unsuccessful roll means that the object never arrived where it was supposed to and could be anywhere within the mage's range.

## Time Slip

**Range:** Self  
**Duration:** ½ melee (7 seconds).  
**Saving Throw:** None  
**P.P.E.:** Fifteen

The invocation momentarily suspends time, enabling the spell caster to slip 7 seconds into the future. The mage can move forward seven seconds while all around him are caught in the past. The magic is such that the arcanist can *not* physically hurt any living creature, but can move about the physical environment, open doors, grab an item, run, etc. The effect will appear, to others, as if the character disappears for an instant and then suddenly reappears a few seconds later. All around him lose two attacks that melee round, but the mystic retains all of his.

The time slip is ideal for a quick escape. **Note:** Whatever actions the magician takes within the seven seconds are unseen and unknown to the other characters.

## Tongues

**Range:** Self or others by touch.  
**Duration:** 3 minutes (12 melees) per level of experience.  
**Saving Throw:** None  
**P.P.E.:** Twelve

The magic enables the character to perfectly understand and speak all spoken languages; 98% proficiency. An understanding of written languages is not provided by this magic. *See the "Eyes of Thoth."*

## Words of Truth

**Range:** 5ft (1.5m)  
**Duration:** 1 minute (4 melees) per level of experience.

**Saving Throw:** Standard  
**P.P.E.:** Fifteen

A person affected by this enchantment is compelled to answer all questions truthfully. The arcanist must be within five feet and can ask two brief questions per melee. It is wise to keep questions simple and clear to avoid confusion.

*Saving Throw:* The enchanted person makes a saving throw for each question asked. A successful save means he doesn't have to answer. Questions can be repeated.

## LEVEL SEVEN

### Constrain Being

**Range:** 30ft  
**Duration:** 2 minutes per level of experience.  
**Saving Throw:** Standard  
**P.P.E.:** Twenty

This invocation is useful for controlling lesser supernatural creatures. The enchantment forces the being to obey the arcanist to a very limited degree. Mainly, the arcanist can hold the "thing" at bay with an order like: "Back, stay back", "go . . . begone," "Stay there . . . don't move." "No." "Stop." "Back away." No commands more elaborate than that will be obeyed. The "constrain being" incantation works much like a cross holds a vampire at bay. As long as the mage and his allies stay out of the creature's reach, the magic will hold it at bay. If it can reach out and hurt somebody, it will. If it is attacked, the enchantment is broken and it is free to lash out at anybody. **Note:** Possessing entities and the greater supernatural beings are not affected by this magic.

### Agony

**Range:** 5ft (1.5m) per level of experience.  
**Duration:** 1 minute (4 melees).  
**Damage:** Special  
**Saving Throw:** Standard  
**P.P.E.:** Twenty

A particularly cruel and painful invocation that incapacitates its victim with pain. Under the influence of the magic, the victim has no attacks per melee, can not move or even speak; only writhe in agony. Although there is no physical damage (no S.D.C. or hit points are lost), the pain *is* very real, and it will take another minute for the victim to regain his full composure. During that minute his number of attacks per melee are reduced by half, speed is reduced by half, and he suffers a penalty of -1 to strike, parry and dodge. Only one person can be affected per invocation.

### Animate and Control Dead

**Range:** 400ft (122m)/line of vision.  
**Duration:** 5 minutes (20 melees) per level of experience.  
**Saving Throw:** None  
**P.P.E.:** Twenty

With this incantation the arcanist can animate the remains of dead bodies, human, animal or monster, and mentally control them like a puppetmaster would a marionette. The remains are



not alive and do not have any intelligence whatsoever. It is the sorcerer who controls their actions.

**Restrictions:**

1. The mage can animate and control only two corpses/skeletons, plus one per level of experience.
2. The animated dead must remain in his line of vision. If it can not be seen, it can not be animated.
3. The animated dead can be a corpse or skeleton. *Attacks per melee:* two each, *Speed:* 7, *Damage:* 1D6 from punch, bite,

claw or blunt weapon. Modern weapons, such as guns of any kind, can not be used by animated dead.

4. Only total destruction will stop an animated dead, or knocking out the controlling mage. **S.D.C.** of a small corpse/skeleton, about 3 or 4ft (0.9-1.2m) tall, is 50 S.D.C.; medium, 5 or 6ft (1.5-1.8m), is 80 S.D.C., large, 7 to 12ft (2.1-3.6m), is 140 S.D.C. **Note:** Bullets do  $\frac{1}{3}$  damage, blunt and smashing attacks do full damage, fire does double normal damage. Animated dead can not be stunned nor affected by a death blow or critical hit.



Nancy O'Connor & SPREISSE 7-10-87



## Invisibility (Superior)

**Range:** Self or others by touch.

**Duration:** 3 minutes (12 melees) per level of experience.

**Saving Throw:** None

**P.P.E.:** Twenty

A powerful incantation that makes the spell caster invisible to all means of detection. Infrared, ultraviolet, heat, motion detectors, and even an animal's sense of smell, can not locate the invisible person. No footprints are made, and little sound (Prowl 84%). The magic is broken only if the character makes a hostile move, engages in combat/attacks. At that instant, he becomes completely visible. **Note:** The invisible character is not ethereal and can not walk through walls; he must still use a door. The act of forcing open a door or window, picking a lock, tapping somebody, accidentally bumping somebody, or accidentally getting shot or hurt, is not considered an act of aggression or combat, so invisibility is maintained.



## Invulnerability (limited)

**Range:** Self or others by touch.

**Duration:** 1 melee (15 seconds) per level of experience.

**Saving Throw:** None

**P.P.E.:** Twenty-Five

The magic makes the individual impervious to fire and all energy attacks, impervious to poisons/toxins/gases/drugs, and provides a form fitting energy field which appears as a glowing aura around the body (provides 100 S.D.C.). The invulnerable character is also +10 to save vs magic, psychic assault and horror factor. Once the 100 S.D.C. from the energy field are exhausted, the person will suffer normal damage to his own S.D.C. and hit points.

## Life Drain

**Range:** 30ft (9.1m)

**Duration:** 2 melees (30 seconds) per level of experience.

**Damage:** Special; see description.

**Saving Throw:** Standard

**P.P.E.:** Twenty-Five

The life drain is a debilitating magic that weakens an opponent. The victim will turn pale and experience weakness. Reduce S.D.C. by half, hit points by half, speed by half, attacks per melee by one, and skills are -10%.

Low level arcanists (1-3) can only affect one individual per each spell cast, but at fourth level the mage can also cast the magic on a 15ft (4.6m) area, affecting everyone who enters and remains in the area of enchantment.

Once the magic's duration time has lapsed, the victim's skills and attacks per melee return to normal, S.D.C. returns at a rate of 8 per hour, and hit points return at a rate of 4 per hour. Reduced speed (half) and a feeling of weakness remains for six hours. **Note:** This spell weakens but does not kill.

A successful saving throw means the magic has no affect on the person.

## Metamorphosis: Animal

**Range:** Self or other by ritual.

**Duration:** 20 minutes per level of experience.

**Saving Throw:** None

**P.P.E.:** Twenty-Five

The invocation can completely transform a character into a particular animal, from an alley cat or cocker spaniel to a lion, wolf, alligator or bird. As the animal, the character gets all the inherent abilities and defenses which that animal form may offer, but retains his *own* I.Q., ability to speak, memory, S.D.C. and hit points. The mage can return to human form (naked) at will.

To determine the general abilities of an animal type, use the following tables. **Note:** For an in depth description of animals and their abilities (monsters too), you might want to take a look at *The Palladium Book of Monsters & Animals*.

**Retractable Claws:** Small Cats (lynx, bobcat), damage — 1D6.

Big Cats (lion, tiger), damage — 2D6.

**Claws:** Digging (badger, wolverine), damage — 1D8.  
Miscellaneous (rodent, lizard), damage — 1D4.  
Birds of Prey, damage — 1D6.  
Bear, damage — 1D8.

**Teeth:** Bear, damage — 2D4; Polar Bear — 2D6.  
Canine, damage — 1D6; Wolf — 2D6.  
Feline, damage — 1D6; Tiger/Lion — 2D6.  
Musteline, damage — 1D4; Badger/Wolverine — 1D6.  
Herbivores, damage — 1D4 (horse, goat, ape, human).  
Birds of Prey (beak), damage — 1D4.

**Antlers:** Small Antlers — 1D4.  
Large Antlers — 2D4.

**Horns:** Small Horns — 1D6.  
Large Horns — 2D6.

**Hooves:** Small — 1D6 (kick). Large — 2D6 (kick).

**Speeds:**

Wild Canine — about 35mph maximum for up to an hour.

Small Wildcats — 15mph in spurts of 10 to 20 minutes.

Large Wildcats — 30mph in spurts of 10 to 20 minutes.

Cheetah — 90mph in 3 to 5 minute spurts.

Deer/Antelope — 30mph maximum for up to an hour.

Horse — 40mph maximum for up to an hour.

Elephant — 25mph for up to an hour long.

Rhinoceros — 35mph in 3 to 8 minute spurts.

Alligator — 35mph in 2 minute spurts.



Lizards — 10 to 20mph in 2 to 5 minute spurts.  
Typical Birds — 30mph for up to 1D4 hours.  
Birds of Prey — 40mph for up to 1D4+1 hours.

## NOCTURNAL ANIMALS

### Abilities and Bonuses:

1. Extraordinary vision approximately 10 times better than a normal human's. This means the character can clearly see an 18 inch item up to two miles away (3.2km).
2. Nightvision — 600ft (183m); can see in the dark.
3. Extraordinary sense of smell allows the character to detect very faint scent traces. Tracking by smell is at a skill level of 35%+5% per level of experience. Identify person by scent is a 48% chance.
4. Natural Prowl skill is 65%+5% per level of experience.

## Paralysis: Superior

**Range:** 30ft (9.1m)

**Duration:** 1 minute (4 melees) per level of experience.

**Saving Throw:** Standard

**P.P.E.:** Twenty-Five

This magic temporarily incapacitates its victim, paralyzing him completely. In this state the victim can not move, or even speak. A successful save means the magic has no effect.

## Purification

**Range:** Touch or 3ft (0.9m).

**Duration:** Instant

**Saving Throw:** None

**P.P.E.:** Twenty

The mystic can purify food or water, cleansing it of disease, bacteria and poison/toxins. Up to 50lbs (22kg) of food or 10 gallons of water/fluids can be purified.

## Second Sight

**Range:** 5 miles (8km) per level of experience.

**Duration:** 2 melees (30 seconds).

**Saving Throw:** None; mind block will temporarily prevent the use of second sight.

**P.P.E.:** Twenty

A unique use of magic that enables a mage to see and hear what another person is doing at that very moment. To use second sight, the arcanist must have previously encountered/met the individual. The mage just has to think about that person and he will get a clairvoyant-like vision showing what that person is doing and saying, and who he/she is with. The vision is what one might expect to see in a crystal ball except that the arcanist sees it in his mind. The vision lasts only 30 seconds each time the magic is invoked.

A mage can also use second sight to transmit his present activity to another person. This is a great way to show somebody that you are in trouble. **Note:** The image always consists of true events showing exactly what is happening when it is happening. The vision can not be altered or doctored in any way. Only a mind block will prevent the person from being seen through second sight.

## Wind Rush

**Range:** 120ft (36.6m)

**Duration:** 1 melee (15 seconds).

**Saving Throw:** Standard; to keep balance.

**P.P.E.:** Twenty

This spell creates a short, powerful wind gusting at 60mph, which is capable of knocking people down, knocking riders off mounts, blowing small objects 20 to 120ft away, or creating dust storms.

The wind can be directed by the spell caster at a specific target or a general sweep (maximum wind width — 20ft) can be made. Anyone caught in the wind is helpless and unable to attack or move forward. It takes an additional melee to recover, and 1-8 melees to gather up all items blown away.

**Saving Throw:** A roll of 18 to 20 saves one from losing one's balance and/or losing some item(s).

## LEVEL EIGHT

### Commune with Spirits

**Range:** Self, or others by ritual; 200ft distance.

**Duration:** 5 minutes per level of experience.

**Saving Throw:** None

**P.P.E.:** Twenty-Five

The incantation enables the arcanist to see and speak with all types of "entities," including poltergeists, haunting spirits, trapped entities, imprisoned entities and possessing entities. The ability to see and communicate with these ghostlike beings does not mean that they will obey the character, but a dialogue can be exchanged. **Note:** In this case, the term "entity" specifically refers to the type of supernatural beings known only as entities. See the monster section for details.

### Exorcism

**Range:** 30ft (9.1m).

**Duration:** The spell lasts 3 minutes, results last 6 months or longer.

**Saving Throw:** Standard; 12 by spell or 16 by ritual.

**P.P.E.:** Thirty

Exorcism is a powerful magic that forces a possessing supernatural being to relinquish its control over the enslaved person, animal or object. Forced out of its host body, the evil intelligence will try to possess any other human or animal within the immediate area (30ft/line of vision). The horrid thing gets two attempts at possession. Fortunately, the exorcism incantation protects the person who was its original victim with a bonus of +12 to save vs possession and the mage conducting the exorcism a bonus of +6 to save vs possession. Anybody else in the area has no extra bonus and is in great peril. **If the evil force fails** in both of its attempts to take possession of a host body, roll percentile dice on the following:

**1-52** The evil intelligence is instantly returned to its own dimension.

**53-00** The being can continue to exist in our world, but must immediately flee the area and can not return for at least 6



months. See *possession and possessing beings in the Monster Section*.

**Note:** Ritual exorcism always has a greater chance for success. An exorcism can be repeated by the same character on the same person as often as needed (just be certain the mage has sufficient P.P.E.).

## Hallucination

**Range:** Touch, or 3ft (0.9m).

**Duration:** 3 minutes (12 melees) per level of experience.

**Saving Throw:** Standard

**P.P.E.:** Thirty

The invocation creates a mystic illusion or delusion that the mage implants in the character's mind, thus only that one person experiences the illusion. Whatever the illusion is, whether it be a monster or fire, or bottomless pit or a void or whatever, seems completely real to its victim. The person hallucinating will react and interact with the hallucinatory image regardless of what anybody else may say or do. A successful save vs magic means that the magic has no effect. **Note:** A mind block adds a +3 bonus to save vs hallucination.

## Locate

**Range:** 15 miles per level of experience.

**Duration:** Instant

**Saving Throw:** None

**P.P.E.:** Thirty

Locate is a magic invocation that enables the arcanist to sense the general location of his quarry. The location is limited to a general area or environment, like a specific apartment building, house, shopping mall, church, park, on an airplane headed for New York (or wherever), etc.

To locate a particular person the arcanist must have either personally encountered the individual or a photograph must be provided. **The success ratio for a spell is 41%. The success ratio for a ritual is 89%**, but this also requires an object owned by the person or a lock of hair, or fingernail clippings, or dried blood from that person.

## Luck Curse

**Range:** Touch or 10ft (3m).

**Duration:** 24 hours per level of experience.

**Saving Throw:** Standard; 12 by spell, 16 by ritual.

**P.P.E.:** Thirty-Five

The incantation inflicts the person with *bad luck*. The victim's **normal bonuses** to strike, parry, dodge, and initiative, and roll with punch, are all reduced to zero; no bonuses! **Critical strikes** do normal damage (except a natural 20 which always does double damage); a death or knockout/stun punch does only 1D4 damage. **Kick attacks** have a 60% chance of causing the character to trip and fall down. **Prowl skill** turns into a clumsy roll, making noise every time it is tried. **All skills** are minus -40%, but only during critical situations. The GM can add other minor occurrences of bad luck.

Only a "remove curse" invocation can negate the effect of this enchantment.

## Metamorphosis: Human

**Range:** Self, or other by ritual.

**Duration:** 20 minutes per level of experience.

**Saving Throw:** None

**P.P.E.:** Thirty-Five

A human arcanist can shape change, altering his or her physical structure. The ultimate disguise, the mage can change his height, weight, age, hair color, hair length, skin color, gender, and features. An inhuman being can transform itself to appear completely human.

To attempt to impersonate a real, existing person, the arcanist must have the disguise skill, even though he/she is mentally molding his/her features through magic. A good photograph is required. **The success ratio** for imitating/impersonating the appearance of a real person is the mage's *disguise skill* + 20%. The better he knows the person the more complete the disguise.

In a ritual version of this same magic, the mage can metamorphosize somebody else, rather than himself. Also in the ritual magic, the mage can metamorphosize someone else into an exact duplicate of himself. Furthermore, a captive at the ceremony can be duplicated without flaw. **Note:** The metamorphosis process only changes the appearance of the body. The transformed person retains his own voice, memory, skills, and attributes/abilities.

## Minor Curse

**Range:** Touch or 10ft (3m).

**Duration:** 24 hours per level of experience.

**Saving Throw:** Standard

**P.P.E.:** Thirty

The arcanist can inflict a curse in the form of minor physical disorders that cause a constant irritation. Such disorders include:

**Fever:** -2 on initiative, -5% on all skills, reduce speed and endurance (P.E.) by 25%. Fever ranges from 99 to 102 degrees, victim feels drained, tired, uncomfortable.

**Gas:** Some indigestion and nausea, bloated feeling. Farts once every two melees (pee-u). -2 on initiative, sneak attacks and prowl are impossible.

**Headache:** Dull, throbbing headache; sleep and concentration are difficult. All skills are -10% and all saving throws are -1 (lack of focus).

**Hiccps:** Annoying; interrupts speaking constantly. Language skills are -15%, mental affinity (M.A.) is reduced by half. Prowl is impossible. Spells can still be cast with little difficulty.

**Ingrown Toenail:** Painful to walk, victim limps. Reduce speed by 1/3, prowl is -10%, climb is -15%.

**Itching and Rash:** Very uncomfortable; almost maddening itch that can be relieved only by scratching. Reduce mental affinity (M.A.) by half, -4 on initiative and minus one attack per melee.

**Pimples:** Dozens of pimples break out all over the face and arms. Reduce physical beauty by half.

**Nausea:** Stomachache, loose bowels and vomiting, slow this poor victim down. Reduce speed to a comfortable half normal (running faster is possible, but there is a 50% chance of vomiting). Sudden movements, bumpy rides or high speed chases (50mph or faster), have a 60% chance of inducing



vomiting or diarrhea. The victim is -6 to strike, parry and dodge while throwing up, and has no initiative.

**Runny Nose and Cough:** The victim suffers from a nagging, constant cough, watering eyes and runny nose. Reduce physical beauty (P.B.) by 25%. Prowling and sneak attacks are impossible. Spell casting is unimpaired.

**Vertigo:** The character gets dizzy when running (speeds higher than 8), during high speed chases (50mph or faster), or when exposed to heights (must be looking out a window or standing on a ladder or ledge, and so on, higher than 10ft). When vertigo hits, the character is almost helpless: reduce attacks per melee to one, no initiative, (minus) -8 to strike, parry or dodge. The vertigo will last as long as the victim is exposed to what induces it.

No normal medicine or cures will rid a character of a curse. Only a remove curse incantation can do it, or waiting until the duration time of the curse elapses. A negation spell can be tried, but it has only a 25% possibility of success.

## Negation (Of Magic)

**Range:** Touch or 60ft (18.3m).

**Duration:** Instant

**Saving Throw:** Special (Ritual magic has a greater chance of success).

**P.P.E.:** Thirty

This incantation will instantly cancel the effects or influence of most magic. To determine whether the negation is successful or not roll a saving throw. If the roll is a successful save against the magic used, its influence is immediately destroyed/negated/canceled. 12, 13, 14, or 15 is needed for spell magic depending on the experience level of the mage (usually 12 or 13 is needed, or 16 and higher to save vs ritual magic). A failed save means the negation attempt did not work. Try again if sufficient P.P.E. is available.

**Negation will not work against** possession, exorcism, constrain being, banishment, talisman, amulet, enchanted objects, symbols/circles of protection, wards, summoning magic, zombies, golems, restoration or healings/cures. Negation can be attempted to cancel a curse, but only has a 25% possibility of succeeding, and that's only if the saving throw was successful. Of course, it has *no* affect against psychic abilities or the machines of a psi-mechanic.

## Oracle

**Range:** Self

**Duration:** 1 minute (4 melees)

**Saving Throw:** None

**P.P.E.:** Thirty

The oracle is the magic equivalent of divination combined with clairvoyance. The arcanist receives a dream-like vision of a possible future. The focus of the vision will depend on what, when or whom the mage is thinking about. The same basic rules that apply to divination and clairvoyance apply to the "oracle" invocation.

## Sickness

**Range:** Touch or 20ft (6m).

**Duration:** 12 hours per level of experience.

**Saving Throw:** Standard

**P.P.E.:** Thirty-Five

Sickness is a debilitating magic which afflicts its victims with the symptoms of a specific disease. Only the symptoms of the disease manifest themselves, not the actual disease. Consequently, a medical examination will show there to be no physical cause to the illness. At best, it will be diagnosed as psychological or unknown. No matter how ill or helpless the victim may become he can not die from the magic sickness. But the character will suffer greatly.

All sickness inflicted by this magic is severe, inflicting the following penalties and modifiers: Attacks per melee are reduced to one, physical endurance is reduced by 70%, -4 to strike, parry and dodge; no initiative, and skills are reduced by 40%. The person is very weak, disoriented and uncomfortable.

## Spoil

**Range:** Touch or 3ft (0.9m)

**Duration:** Instant

**Saving Throw:** None

**P.P.E.:** Thirty

Basically, this magic is the opposite of the purification (food/water) incantation. In this case, the mage can instantly transform good food into spoiled, affecting 50lbs (22kg) or 10 gallons (37.9 liters) of water/fluids, making the food inedible and the water undrinkable. Anybody who forces themselves to eat or drink the horrible tasting food or drink will get sick with stomach cramps and diarrhea. Penalties: -1 on initiative, -1 to strike, parry and dodge.

## LEVEL NINE

### Curse: Phobia

**Range:** Touch or 20ft (6m).

**Duration:** 24 hours per level of experience.

**Saving Throw:** Standard

**P.P.E.:** Forty

The phobia curse implants in its victim an unreasoning fear of something (see phobia in the Insanity section). The arcanist can select one of the phobias listed in the insanity section or make a random roll on that table or introduce a new phobia (new phobias must be approved by the game master). The victim of the curse will have a phobic reaction every time he encounters that fearful thing. Only a "remove curse" is a 100% cure, "negation" has a 25% chance of success, and, of course, the arcanist who created the curse can cancel it at any time.

### Familiar Link

**Range:** Self and animal/600ft (183m).

**Duration:** Indefinite

**Saving Throw:** None

**P.P.E.:** Fifty-Five

At third level the arcanist is experienced enough to mentally link with a small animal (mammal, bird or lizard). This link is permanent, producing a rather impressive symbiotic relationship. No matter how wild or mean the animal may have been, it will be instantly linked to the mage, becoming docile and submissive



to him and him alone. The two are now one. The spell caster is its friend and master, an extension of the animal. The animal familiar will understand and obey any command, verbal or mental. For the arcanist, the familiar is now a sensory extension enabling him to see, hear, smell, taste and feel everything the animal experiences. Thus, familiars make great spies; listening to conversations and prowling into areas not easily accessible to its master. Although the familiar understands and obeys its master, it can not actually speak to him.

Just as the arcanist knows what the familiar is feeling, so does the familiar know what its master is experiencing. If one is in danger the other will know it. Because of the magical nature of the union, the mage and the familiar both get an additional six hit points. However, if the familiar is hurt or attacked, its master also takes the same damage even if miles apart. **If the familiar is killed**, the arcanist *permanently loses 10 hit points*. There is a 50% chance he will also suffer shock from the ordeal; if he does, he will lapse into a coma for 1-6 hours. Another familiar link can not be tried again for at least 1½ years.

#### Other Limitations:

1. Telepathic/empathic communications: maximum range: 600ft (183m).
2. Familiar possesses its normal animal abilities.
3. Size: 25 pounds (11kg) maximum.
4. Usual animal types used: cats, dogs, coyotes, foxes, weasels, rodents, birds, lizards, and snakes.

## Metamorphosis: Insect

**Range:** Self, or others through ritual magic.

**Duration:** 20 minutes per level of experience.

**Saving Throw:** None

**P.P.E.:** Sixty

The mage can transform himself into an insect, including spiders, that is no smaller than a half inch (12.7mm) and no larger than six inches (152.4mm). In insect form, the mage retains his own I.Q., memory, knowledge, hit points, and S.D.C.; however, the performance of human skills is impossible as a bug. Likewise, magic can not be cast because as an insect he can not speak. The metamorphosis can be cancelled at will, but the arcanist will be naked.

*The following are some typical bug abilities:*

#### Bite or Sting:

Nonpoisonous: One hit point or S.D.C. point.

Non-Lethal Poison: 1D6 damage, causes swelling and discomfort.

#### Speed:

Running: Spd. attribute equal to eight.

Climbing: Spd. attribute equal to six.

Flying: 20mph for extended flight.

35mph for short bursts (30 seconds).

**Note:** Seems to never tire and can walk on any surface.

#### Abilities and Bonuses:

1. Prowl: Small insects, 2 inches or smaller — 90%; larger insects, 2½ inches or bigger — 66%.
2. Natural climbing ability on any surface is 98%, spiders can rappel.
3. Bonus to automatically dodge is +6.
4. Range for hearing is 50ft (15.2m).

5. Range for vision is 50ft (15.2m), but has 180 degree peripheral vision, making sneak attacks impossible (automatic dodge).

## Protection Circle: Simple

**Range:** Radius of the circle.

**Duration:** 24 hours, plus 4 P.P.E. to reactivate after the circle's initial creation.

**Saving Throw:** None

**P.P.E.:** Forty-Five

Even as a spell, this invocation might be considered a ritual, for it requires the physical drawing of a circle and symbols while the spell incantation is recited. Chalk or charcoal, or almost any substance, can be used to draw the circle. 45 potential psychic energy points are needed to initially create the circle, but a mere four P.P.E. is all that is needed to reactivate it. Anybody with sufficient P.P.E. and desire can reactivate a protection circle. However, if the circle is damaged (scraped, scarred, rubbed out, etc), it will not function and a new one will have to be created.

The simple protection circle will protect everybody inside its radius by keeping *lesser* supernatural creatures ten feet (3m) away from the circle. The creatures can not come any closer, nor enter the circle. The circle also provides its occupants with a bonus of +2 to save vs magic and psychic attack.

Although lesser supernatural beings, such as entities, ghouls, and gremlins, can not come near or enter the circle, they can hurl objects, use weapons, or use magic and psychic powers against the person(s) inside the circle. *Greater beings*, such as vampires, elementals and demi-gods, are not affected by the simple circle and can enter effortlessly. No bonuses vs magic apply against these powerful beings either.

## Summon & Control Canines (Pentacle)

**Range:** Varies

**Duration:** 5 hours per level of experience.

**Saving Throw:** Standard animal, but only if a part of the player characters' group.

**P.P.E.:** Fifty

All pentacles or pentagrams are used for summoning or potentially evil intent. The Chinese geomancers found that *circles* represent mutual support, the cycle of life, and flowing energy. But the *pentacle*, the five pointed star, represented mutual destruction and evil. That is why all protection magic incorporates the circle symbol and all summoning utilizes the pentagram.

The summon & control canines pentacle will provide 1D4 canines (dogs, wolves, etc.) plus one additional canine per level of experience. The animals will be under the complete control of the mage, obeying his every command, and will fight to the death. The pentacle will also give the arcanist the power to control any other canines which were not originally summoned, within 200ft/line of vision, as long as the mystic remains in the pentacle. The canines originally summoned will obey the arcanist in and out of the pentagram for the duration of the enchantment, then leave.



## Temporary Insanity

**Range:** Touch or 20ft (6.1m).

**Duration:** 1 minute (4 melees) per level of experience.

**Saving Throw:** Standard

**P.P.E.:** Sixty

With this powerful magic the arcanist can instill an unreasonable need, desire or motivation/emotion into another person. The enchanted person will then be compelled to *immediately* respond to his feelings. A simple suggestion or command must be spoken by the mage, such as: "He hates you. Kill him before he can kill you. Kill him!" The afflicted character will react immediately and try to kill that person, regardless of alignment or personal relationship. Another example is: "That is yours (a particular item). Don't let them take it from you. Get it, Now!" The character will instantly want the item and will do anything to get it. Or "You love me, don't let them hurt me. Stop them." And so on. The insanity is a completely overwhelming and *irrational* compulsion and *violent* reaction, usually uncharacteristic for that person. **For Example:** Suddenly attacking a friend or ally and shouting "I hate you! Die!" is not normal. As soon as the magic's duration time elapses the victim instantly returns to his/her normal self and will not understand what suddenly came over him/her.

*The enchantment* dulls the victim's normal reaction time and thoughts, inflicting the following penalties: minus one attack per melee, -1 to strike, parry and dodge, but +3 on initiative. The victim can not be made to commit suicide.

## Transferral

**Range:** Touch or 10ft (3m).

**Duration:** One hour per level of experience.

**Saving Throw:** Standard

**P.P.E.:** Fifty

The arcanist can use this magic to temporarily transfer his mystic essence into another person by transferring all but 4 P.P.E. and experience into that individual. A See Aura would reveal no magic, little P.P.E. and no level of mystic experience. It is an excellent way to hide one's mastery of magic when needed.

*The person* to whom the P.P.E. and experience have been transferred is completely unaware of the power within him and can *not* use it. *The mystic* who has temporarily drained himself of magic retains his mystic knowledge, but has only 4 P.P.E. and can create magic only at first level proficiency. He can regain his power by touching the person who holds it or by waiting until the magic's duration time elapses.

## LEVEL TEN

### Banishment

**Range:** 100ft (30.5m)

**Duration:** 2 weeks per level of experience.

**Saving Throw:** -1 per every 2 levels of the arcanist.

**P.P.E.:** Sixty-Five

A useful invocation for controlling supernatural beings is Banishment. The magic forces one lesser supernatural being, per experience level of the arcanist, to leave the immediate area

(2 mile/3km radius). The creature(s) can not return for at least two weeks per level of experience. Each lesser being gets to roll to save vs the magic. A successful save means it is not banished and can stay to cause trouble. As always, a banishment ritual has a greater chance of success (16 or higher is needed to save.)

## Bonding

**Range:** 12 miles (19km) per level of experience.

**Duration:** Varies with each individual spell.

**Saving Throw:** Standard, with a (minus) -1 penalty to save.

**P.P.E.:** Eighty plus the cost of the additional magic.

Bonding is a powerful *ritual* incantation that combines magic to strike at somebody from a great distance. It is a common ritual in the practices of voodoo. The arcanist makes a clay, straw or rag doll in the image of a man or woman. Then a lock of hair or fingernail clippings from the intended victim is glued to the doll effigy. To complete the magic the incantation is performed and the *victim's true name* (first, middle, and last) must be known (if the person has no middle name, only the first and last must be known). When this has been done, the doll is magically linked to that specific individual. This means that non-energy magic, like befuddle, fear, breathe without air, trance, calling, heal wounds, compulsion, sickness, curses and so on, can be cast on the doll effigy and it will affect the *real* person. *Summoning and protection magic*, as well as *energy magic* like energy bolt, call lightning, fire bolt, telekinesis, etc., can not be used on the doll with any effect.

*Pins and needles* can be used to inflict stabbing pain into the victim. This is done by stabbing the doll with a pin or needle. Wherever the needle is stabbed will inflict a terrible pain: leg, arm, chest, stomach, etc., that will temporarily incapacitate the character. The victim will double over with pain, losing all but one attack that melee and is -4 to strike, parry and dodge. Despite the great pain, the needle inflicts only one S.D.C. point of damage each time. *Fire* can be used to wear a character down with fever-like symptoms: feels like he's burning up from heat, sweats profusely, speed is reduced by 25%, skills are -5%, -1 to strike, parry and dodge. Needles and fire can be inflicted for a total of one minute (4 melees) per experience level of the enchanter. The magic spells or ritual magic will last as long as the normal duration for that particular spell. No more than two spells can be inflicted on the victim at any one time.

**The initial bonding ritual** requires 80 P.P.E. *plus* the P.P.E. cost of whichever invocation is being cast on the victim. The mystic assault happens as soon as the spell is finished and will last the usual length of that spell. Shortly after the spell is cast the bonding magic becomes too weak to transmit other magic. However, the link between the living person and the doll continues to exist. The mystic can bring the bonding magic back up to full power (and be able to inflict more magic on its victim) by repeating the bonding incantation and spending 40 P.P.E. points. Each renewal provides the arcanist with the opportunity to inflict more magic on his victim or one minute (4 melees), per level of experience, to use needles or fire on the doll. Remember, no more than two spells/invocations can be used on a person at any given time. Consequently, if the victim is still under the effect of an invocation, only one new one can be cast upon him. The victim always gets to save vs each magic spell/attack directed at him. A successful save means it has no effect;



try again. As always, the base saving throw versus spell magic is 12, while versus rituals is 16.

## Curse: Paranoia

**Range:** Touch or 20ft (6.1m).

**Duration:** 24 hours per level of experience.

**Saving Throw:** Standard

**P.P.E.:** Seventy

This curse inflicts extreme paranoia on its victim. The poor individual will become convinced that he can trust or believe no one, regardless of past friendships. The afflicted character will see everybody as sinister and treacherous beings, probably associated with supernatural evil. They all covet his possessions, knowledge or death. Any act of aggression toward the paranoid will convince him of treachery and he will react in kind. *General reactions* will include secretiveness, hiding data and items of importance, staying aloof and alone, lying, and an immediate, hostile counter-response to any perceived threats.

## Control/Enslave Entity

**Range:** 30ft (9.1m)

**Duration:** 48 hours per level of experience.

**Saving Throw:** Standard

**P.P.E.:** Eighty

Another incantation used to control supernatural forces. This magic does not summon entities, but does enable the mage to control them when encountered. The arcanist can control two entities per each of his levels of experience. All varieties of entities are susceptible to this enchantment. Each individual entity gets to make a saving throw vs magic. A successful save means it is not controlled by the arcanist. A failed roll means it will obey the arcanist to the best of its ability (some are barely intelligent).

At the end of its mandatory service to the arcanist, the mage can try to renew his control by invoking the control invocation again, banish the creature (see Banishment), or just let his control slip away. The latter can be dangerous, because the evil beings *may* turn on the mage to extract vengeance or just out of spite. On the other hand, the more intelligent types may willingly agree to work with an arcanist, especially an evil one, if it will help the diabolical being in its own schemes or to inflict pain and suffering.

## Metamorphosis: Superior

**Range:** Self, or other by use of ritual only.

**Duration:** 20 minutes per level of experience.

**Saving Throw:** None; standard if an unwilling victim.

**P.P.E.:** One Hundred

This incantation enables the spell caster to transform himself into any real, living creature: animal, human or insect. The usual limitations and abilities still apply. The arcanist can also transform himself to *resemble* a supernatural creature, but does not possess any of its powers or abilities, only his own normal, human abilities (I.Q., memory, attributes, hit points, S.D.C. et cetera.).

A person other than the arcanist can be transformed, but lengthy ritual magic must be performed to do so. The individual will remain in metamorphed form until the spell's duration elapses or the mage who invoked it cancels it.

## Summon and Control Rodents (ritual)

**Range:** 600ft (183m)

**Duration:** Five hours per level of experience.

**Saving Throw:** Standard animal

**P.P.E.:** Seventy

This pentacle of summoning produces an army of mice or rats that obey the will of the arcanist who summoned them. As long as the mage stands in the pentagram he can control any other types of rodents. **Note:** Familiars are not affected.

The sorcerer can summon 30 rodents per level of experience. Mice and rat bites inflict one point of damage each. Mice have one attack per melee, rats have two. All are +1 to dodge and are excellent climbers.

## Wards

**Range:** Varies with type.

**Duration:** Effects vary with type.

**Saving Throw:** Standard; spells are base 12, wards created by ritual magic are 16.

**P.P.E.:** Ninety

The ward's invocation creates mystic symbols used to protect items of value, to protect dwellings, and as booby traps. The ward can be cast on a door or window, a section of floor, a cabinet or on a specific item such as a book or statue. The ward symbols on the object are always obvious, to serve as a *warning*. When somebody, other than the arcanist who created them, touches the object, a spell is triggered. The following wards can be created. Each ward invocation will create two separate wards, the ritual invocation will create three. The object to be warded must be present.

**Alarm:** A screeching, siren-like noise is instantly sounded and continues to blare for TEN minutes. The sound can be *easily* heard through closed doors up to 100ft away.

**Fear:** An aura of fear engulfs everybody within a 20ft area of the ward. Each person must roll to save vs magic or be overwhelmed by terror. Effects are identical to the second level fear invocation.

**Fire Bolt:** The person touching the item is struck by a fire bolt causing 6D6 damage; no saving throw is applicable. Same as the fourth level invocation.

**Paralysis (lesser):** The ward temporarily paralyzes the person's hand and arm for 1D4 hours. Effects are identical to the third level invocation.

**Sleep:** The ward will put to sleep everybody within a ten foot area around it. Each person must roll to save versus magic. The sleep lasts for 6D6 minutes. Effects are identical to the fifth level spell.

**Agony:** The person who touches the object is wracked with agony for 2D8 melees. The effects are identical to the seventh level invocation.

**Curse (minor):** Inflicts a minor curse identical to the eighth level invocation except that it will linger for 1D6 weeks.

**Curse (phobia):** Inflicts a phobia curse identical to the ninth level invocation except that it will linger for 1D4 weeks.

**Banishment (counts as two wards):** Will instantly force lesser supernatural beings from the area, just like the tenth level invocation. Plus, the creature must leave the object where it rests.



After a ward has been triggered, its magic is used up and it disappears. A ward can last for centuries if left undisturbed. The life span of a ward is 150 years per level of the arcanist.

## LEVEL ELEVEN

### Create Mummy (ritual)

**Range:** Touch

**Duration:** Exists until destroyed.

**Saving Throw:** None

**P.P.E.:** One Hundred Sixty

The mummy invocation is a necromantic ritual that turns a corpse into one of the undead. The ritual involves treating pure linen strips of cloth with a mystic solution and wrapping the body in the cloth. The incantation brings to life (if you can call it that) a sort of humanoid robot devoid of emotions and fearless. Like a machine, the barely intelligent "thing" follows simple orders to the best of its ability. The mummy is incapable of understanding complex commands, or performing any skills. It is simply a lumbering corpse. Of course, this combined with its near indestructibility makes it an ideal guardian. A simple command like "Kill all who enter." (with the exception of the mage) is all that it needs to know. A mummy can not speak (or read) but grunts, growls and howls.

The most devastating aspect of the damnable creature is that it is dead, and feels no pain or emotions. Bullets, knives, clubs, and even most magic, have no affect against the monster. Physical attacks simply nick or poke holes into a lifeless husk. Magic charms, sleeps, curses, illusions, illness, paralysis, and turn dead (the mummy is an undead) do nothing at all. Banishment does not work because the mummy is not actually a living supernatural creature. Negation simply does not work and remove curse is not applicable.

**The only way to stop a mummy** is to: 1) Trap or imprison it. 2) Blow it to bits. 3) Burn it up. **Note:** Protection circles will hold a mummy at bay. *Fire* is its one major weakness and it knows that, so a wall of fire or a torch or flamethrower may also keep it at bay. The magic is present in both the dead body and the linen wrappings. *If the wrappings are destroyed*, fire does double damage to the corpse, and even sunlight will inflict 3D6 points of damage per melee of exposure.

#### The Mummy

- I.Q. 4, P.S. 20, Speed 7
- Three attacks per melee, 2D6 damage by hand/punch.
- +5 to damage.
- +1 to parry, no dodge or initiative bonus.
- Most psychic powers and magic have no effect.
- Fearless; no horror factors scare it. However, small fires have a horror factor of 7 and larger fires, man-sized or bigger have a horror factor of 13.
- S.D.C. of linen wrappings: 50 (bullets do effectively no damage).
- S.D.C. of Corpse: 70, but only fire and explosives damage it. Sunlight hurts it only if all or most of the protective cloth wrappings have been destroyed. A typical torch will do 1D6 damage each time it is struck by one.

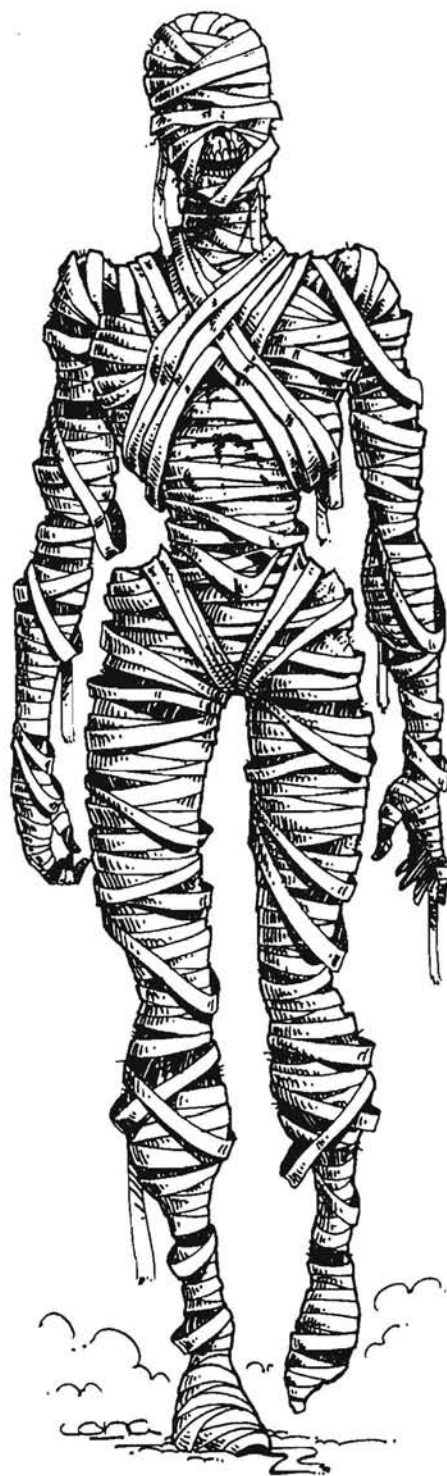

### Curse: Neurosis

**Range:** Touch

**Duration:** 24 hours per level of experience.

**Saving Throw:** Standard

**P.P.E.:** Ninety-Five

The incantation afflicts its victim with a neurotic disorder. The arcanist can implant one specific neurosis or roll on the random neurosis table in the insanity section. The insanity is temporary and fades away several days after the duration time has elapsed.



## Immure Entity

**Range:** Touch or 20ft (6.1m).

**Duration:** Instant; imprisonment is indefinite.

**Saving Throw:** Standard

**P.P.E.:** Two Hundred

This invocation is not a summoning ritual, but is extremely useful in directing and controlling supernatural "entities." Immure can actually imprison an entity inside an object. The act of imprisonment can be punishment or as part of a scheme. An imprisoned entity still retains all of its abilities, although it is trapped. Consequently, a seemingly harmless ring or medal could contain a poltergeist, trapped entity, or a possessing entity which can still use its abilities to help or hurt. The immured entity must obey the mage who imprisoned it and can not strike out at him while imprisoned.

There are only two ways to free an immured entity. The arcanist who trapped it releases it by cancelling the magic, or by destroying the object in which it is imprisoned. To prevent easy escape, the arcanist will usually use a hard, durable substance, such as metals, stones and gems, but any non-living substance can be used (wood, skull, etc.).

*See entity in the monster section for specific types and powers.*

## Remove Curse

**Range:** Touch or 10ft (3m).

**Duration:** Instant removal.

**Saving Throw:** None

**P.P.E.:** One Hundred Forty

The arcanist can attempt to remove any type of curse using this incantation. To determine success a 20-sided die is rolled (plus bonuses) to save vs magic. A successful save means that the curse is instantly gone. A failed roll to save means the curse is still in effect. Try again with a new invocation and another 140 P.P.E.

The remove curse is a powerful magic that provides bonuses to save vs magic and to remove that curse. Those bonuses are:

Spell: +5 to save

Ritual: +10 to save

## Summon and Control Animals (ritual)

**Range:** 600ft (183m)

**Duration:** 5 hours per level of experience.

**Saving Throw:** Standard for animals.

**P.P.E.:** One Hundred Twenty-Five

A superior summoning pentacle, the invocation empowers the arcanist to summon and control any type of animal.

**Tiny animals** like frogs and mice — 40 per level of experience.

**Medium-sized animals** like dogs and cats (up to 30lbs) — 8 per level of experience.

**Large animals** like horses — 6 per level of experience.

**Exotic animals**, including animals which are not indigenous to the area; i.e., animals such as a tiger, panther or elephant are not native to New York city. Only *one* per level of experience.

As usual, any animal which comes into the arcanist's 600ft (183m) range while in the pentagram will obey the mage unless it makes a successful save vs magic. Familiars are not influenced by the control animal pentagram.

## Summon Fog

**Range:** Up to 10 miles away per level of experience.

**Duration:** 1 hour per level of experience.

**Saving Throw:** None

**P.P.E.:** One Hundred Forty

The arcanist can call forth a dense fog that will impair vision and make travel difficult. **The fog** is so thick that a person can see clearly for four feet (1.2m) and see only blurred, shadowy figures and shapes for about another 10ft (3m). Anything beyond 10ft (3m) is totally obscured by fog. The fog can be made to cover a *one mile area* (1.6km) per each experience level of the arcanist.

*Safe travel* is slowed to a crawl. On foot, a safe speed is 10 or less, and even then there is a 30% chance of tripping over something every 30ft or so (9.1m). A completely safe speed is 3. Running faster than a speed of 10 is hazardous, with a likelihood (60%) of falling every 30ft of travel. All sense of direction is lost. A safe speed for an automobile is 5mph (8kmph). Up to 20mph can be attained, but the risk of running off the road is 60%, and for every half mile there is a 40% chance of crashing into something. Traveling faster than 25mph is certain disaster, with an 85% likelihood of running off the road and a 70% chance of crashing. Roll for every 600ft (183m). Air travel is impossible.

**Bonuses or penalties?** The fog adds a +20% to prowl skills. *Long-range combat* and gunfights are extremely difficult. All such attacks, including distance magic and psychic attacks, are -5 to strike and opponents are +2 to dodge each other's attacks.

The summoner can cancel the fog at any time or let it last out its full duration. It can be summoned day or night, any time of the year.

## LEVEL TWELVE

### Amulet

**Range:** Holder/wearer of the amulet.

**Duration:** Exists as long as the medallion is not destroyed.

**Saving Throw:** None

**P.P.E.:** Two Hundred Ninety or more.

The "amulet" is a potent invocation that instills a medallion or charm with mystic properties that will protect an individual from magic or supernatural forces. The only requirement of the invocation is that the amulet be made of one metal purified by fire or made of semiprecious stone.

*The sole purpose of an amulet is to protect.* Protection is provided in several different ways. Any one of the following can be created by the amulet invocation.

**Charm:** A general ward against magic, that provides a bonus of +1 to save versus magic and psychic attacks. **P.P.E. Cost:** 290.

**Protection Against Sickness:** Amulet that specifically protects against the eighth level magic invocation "sickness." Bonus of +6 to save. **P.P.E. Cost:** 290.

**Protection Against Insanity:** Adds a bonus of +4 to save against *all* magically induced insanities. **P.P.E. Cost:** 320.

**Protection Against the Supernatural:** Adds a bonus of +2 to save vs horror factor. **P.P.E. Cost:** 300.

**See the Invisible:** Enables only the wearer of the medallion, to see the invisible. **P.P.E. Cost:** 500.



**Sense the Presence of Spirits:** The amulet changes color whenever an entity(s) is in the area. Range: 60ft (18.3m).

**P.P.E. Cost:** 310.

**Turn the Undead:** A charm that will prevent any of the undead from physically touching them while they wear or hold the amulet. The amulet works much like a cross does against vampires. Effective against all undead including mummies, zombies and vampires. **P.P.E. Cost:** 400.

## Calm Storms

**Range:** Immediate area around the mage, affecting a one mile (1.6km) area per level of experience.

**Duration:** 1 hour per level of experience.

**Saving Throw:** None

**P.P.E.:** Two Hundred

The arcanist can calm the tumultuous tempest of nature with a simple invocation and 200 points of potential psychic energy. As a spell, the mage can slow a downpour to a light rain, reduce wind speed by half, reduce waves by half and lighten the dark, stormy skies.

Using ritual magic the mystic can turn a torrential rain into a drizzle, reduce winds to a gentle breeze, shrink ocean waves to normal, disperse a tornado in an instant and get the sun to peek through clearing skies.

**Note:** Calm Storms is effective against natural and magically induced storms.

## Create Zombie (ritual)

**Range:** Touch

**Duration:** Exists until destroyed.

**Saving Throw:** None

**P.P.E.:** Two Hundred Fifty

The zombie invocation is a necromantic ritual that turns a corpse into the undead. To create a zombie, the sorcerer must find a recently deceased body, no more than six hours dead, lay it on a white or silver linen, draw a circle around it and light three scented candles. The candles are then placed on the body: one on the forehead, one on the mouth and one on the chest above the heart. As the incantation reaches its climax, the mage cuts his finger and draws a pentagram on the corpse's throat with his still warm blood. Moments later, the monstrosity rises to pseudo-life, the obedient slave of his creator. The ceremony must be done secretly in a graveyard or burial place during a night of a full moon.

The zombie is more intelligent than the mummy and can speak, read simple signs and sentences, perform simple tasks and even drive a car. This means a zombie(s) can be sent to retrieve an artifact, follow somebody, kidnap a person and so on. A zombie will only obey the person who created it and individuals whom its creator may designate as authorities.

Like the mummy, a zombie is a walking corpse. It feels no pain, no fears, no goals and little emotion. Bullets, knives, clubs, and other physical attacks do **NO** damage. Mental assaults by psychics, magic charms, illusions, sleeps, curses, sickness, paralysis, and other similar attacks, do **no** damage. Turn dead does not work because the zombie is an undead. Banishment doesn't work because it is not actually a living supernatural being. Negation simply does not work and remove curse is not

applicable. However, the zombie is more vulnerable than the mummy, the trick is knowing what to use.

A zombie is vulnerable to *magical energy attacks*, such as energy bolt, fire bolt, circle of flame, and call lightning, all of which do full damage. *Normal electricity*, lasers, particle beam weapons and similar energy weapons do half their normal damage. *Normal fire* inflicts full damage. Weapons made of, or covered in *silver*, will do full damage whether it be blade or bullet. Zombies can also be trapped/imprisoned and blown up.

**Zombies will rise again**, even if riddled with silver bullets or blown to bits, unless their heads are severed from their bodies and buried separately, or an exorcism is performed. Otherwise, it will regenerate *all* S.D.C. and body parts within *48 hours* and seek out its master for new instructions. There is no limit to the number of zombies a mage can command. Horror stories in Haiti whisper of entire sugar cane plantations worked by zombie laborers.

## ZOMBIES

- Horror Factor: 12
- I.Q. 7, P.S. 20, Speed 10.
- Two attacks per melee, 2D4 damage by hand/punch or by weapon. Guns can be used, but at -4 to hit.
- +2 to parry and dodge. No initiative bonus.
- Most psychic and magic powers have no effect, only energy.
- Fearless; no horror factor scares it. However, large fires and energy weapons/barriers will hold it at bay. A protection circle will also keep it away.
- S.D.C.: 150; will regenerate within 48 hours unless head and body are buried separately.

## Metamorphosis: Mist

**Range:** Self; or others through ritual magic.

**Duration:** 20 minutes per level of experience.

**Saving Throw:** None; standard if an unwilling subject.

**P.P.E.:** Two Hundred

Said to be the most powerful of all the metamorph magics, the arcanist can transform himself into a mist. As a mist, no physical or energy attacks can harm him. No locked door can stop him, for he can slip through the tiniest crack or keyhole. Although the mystic can not communicate or cast magic, he can hear and see events around him as would a normal human being. Of course, he can materialize (naked) with a thought.

The mist moves at a maximum speed of 14. Prowls (natural, innate ability) at an 80% skill proficiency, is completely silent, can hover up to 100ft high (30.5m) and is semitransparent.

## Summon and Control Entity (ritual)

**Range:** Not applicable.

**Duration:** 24 hours per level of experience.

**Saving Throw:** None

**P.P.E.:** Two Hundred Fifty

An impressive ritual, the magic invocation plucks an entity (specific type can be designated) out of its native dimension, and magically teleports it to appear before the conjurer. The alien being is automatically under the mage's control and will obey him without question. The entity can be used for any purpose: manual labor, protection, assault, etc.



The supernatural creature can be returned to its own world at any time before the duration time of the invocation elapses. After the duration time elapses, the entity slips out of the mage's control and remains in our world. If it suits the entity, it may elect to work with the arcanist or it can be enslaved by other mystic means. An unhappy or vengeful entity may attack the mage at the first opportunity after the mage loses control.

See entity in the monster section for details about types and powers.

## Summon and Control Rain (ritual)

**Range:** Immediate area around the mage or up to 10 miles away per level of the experience.

**Duration:** 1 hour per level of experience.

**Saving Throw:** None

**P.P.E.:** Two Hundred

The arcanist can create a rainstorm out of thin air. The rain can be controlled to be a drizzle, light rain or downpour. One mile (1.6km), per level of experience, can be affected by the rain. A heavy storm will reduce visibility and slow travel.

## LEVEL THIRTEEN

### Create Golem (ritual)

**Range:** Touch

**Duration:** Exists until destroyed.

**Saving Throw:** None

**P.P.E.:** Stone: 500 or Iron: 700

The sorcerer first draws a pentagram in animal blood. Second, he sculpts a golem (humanoid shape) from clay. Third, he places two onyx gems, valued at no less than \$1000 each, for eyes. Fourth, he places a heart, molded out of iron, into the clay body. Lastly, the mage recites the ritual ceremony. At the end of the ritual, the mystic places a single drop of his blood on the behemoth's forehead to bring it to life. The process permanently drains the mage of 6 S.D.C. points.

Both the stone and iron golems are mystical creatures born of magic and almost indestructible. Since they are not of flesh and blood, psychic and magic attacks designed for the human physiology and mind do not affect them. That means charms, sleeps, bio-manipulation, illusions, paralysis, etc., have no effect. Since the horrid thing was never alive, turn dead is *useless*, as is banishment, negation and remove curse. *Physical attacks* and *energy magic* can hurt a golem, but do half damage (even explosives), and then only if the roll to strike is higher than its A.R. (armor rating). Any rolls to strike under the golem's A.R., 14 or 17, bounce off harmlessly.

In many respects, a golem is like the mummy, only bigger and tougher. It can not speak, nor read or understand complex commands. It has no emotions, no fears, and is like a robot waiting for a direction. Golems will obey only the person who created it. When the creator dies, the golem will follow his last command until it is destroyed.

### GOLEM

- Horror Factor: 16
- I.Q. 6, P.S. 25, Speed 8, Height: 6ft to 18ft (1.8-5.4m).
- Four attacks per melee, 2D6 damage by hand/punch.
- +10 to damage.
- No bonus to parry or dodge or on initiative.

- Impervious to most psychic and magic attacks. Magic energy attacks and normal weapons, like guns, knives and clubs, will do only half damage.
- Impervious to normal fire (magic fire does half damage).
- Armor Rating (A.R.): 14 — stone or 17 — iron.
- S.D.C.: 150 stone or 300 iron.
- Regenerates completely within 24 hours unless its heart is removed.

## Protection Circle: Superior

**Range:** Radius of the circle.

**Duration:** 24 hours; but can be reactivated immediately at a cost of 20 P.P.E.

**Saving Throw:** None

**P.P.E.:** Two Hundred Fifty

In principle and function, the superior protection circle is just like the simple circle, only stronger. The arcanist must recite the invocation while drawing the circle in chalk or any substance. 300 P.P.E. are needed to initially create the circle, but a mere 20 P.P.E. points will reactivate it. Anybody with sufficient P.P.E. and desire can reactivate a protection circle. The circle ceases to function only if it is seriously marred.

The superior protection circle will protect everybody inside its radius by preventing all supernatural creatures from coming any closer than 20ft (6.1m) from its edge. Even greater beings are held at bay. *Lesser beings* can not stand to be within *line of sight* of the circle and are forced to leave (even if it's only to the next room with the door shut). This means no attacks are possible for the lesser beings.

The circle also provides the following bonuses to all occupants: +5 to save vs all magic and psychic attacks, impervious to possession, +8 to save vs horror factor. Plus it provides an *extra* 10 P.P.E. to each arcanist and 10 I.S.P. to each psychic. Of course, the characters are vulnerable to conventional weapons and thrown objects.

## Summon and Control Storm

**Range:** Immediate area around the mage or up to 10 miles (16km) away.

**Duration:** 1 hour per level of experience.

**Saving Throw:** None

**P.P.E.:** Three Hundred

The arcanist can create a destructive storm out of thin air. A rainstorm will create a torrential downpour of 4 inches of rain per hour, causing flooding even in cities. Flooded roads will *immobilize* all vehicles (water is 3 to 5ft high). Poor visibility will slow travel to about 20mph. Traveling fast is likely to cause an accident; roll on the following table for every *two miles* (3.2km) traveled.

- 1-30** No problem, keep going.
- 31-39** Vehicle stalls out. 1-50% chance of restarting.
- 40-69** Vehicle runs off road and is immobilized.
- 70-00** Vehicle crashes into an obstacle or another vehicle. Vehicle is immobilized. All passengers *roll 2D6 damage for every 10mph of vehicle speed*. The storm is accompanied by damaging winds gusting to 35 and 45mph (54 to 72km). The rain and wind makes air travel impossible.

A *windstorm* may be accompanied by light rain, but the real threat is high winds. Winds gust up to 70 and 90mph (112 to 144km) uprooting small trees, knocking



down tree branches and electrical wires, and even overturning an occasional car. Travel on foot is very difficult, reducing a character's speed by 90%. Travel in automobiles is slowed to about 20mph. Traveling any faster is likely to cause the vehicle to run off the road or flip over. Roll 40% + 10% for every 10mph (16kmph) above 20mph (32kmph). Roll once for every 4 miles of travel (6.4km). Air travel is extremely hazardous, but not impossible.

## Summon Lesser Being (ritual)

**Range:** Not applicable.

**Duration:** 24 hours per level of experience.

**Saving Throw:** None

**P.P.E.:** Four Hundred Twenty-Five

An impressive ritual that plucks a supernatural being out of its native dimension and magically places it before the mystic in our world. A specific lesser monster can be summoned if desired, or a random creature can be called for.

The alien being is automatically under the arcanist's control and will obey him without question. The only things it will not do is commit suicide and it may not fight to the death.

The monster can be returned to its own world at any time before the duration time of the invocation elapses. If the creature is not returned and the duration lapses, the mage loses control of the thing and it remains in our world. The creature can be enslaved by other means, may elect to stay with the mage, or wander off to wreak havoc. The only way to send it back to its world is to open a dimensional portal.

See Monster Section for specific creatures.

## Sanctum

**Range:** 30 × 30ft room; can be created up to 200 miles away.

**Duration:** The lifetime of the mage or until canceled.

**Saving Throw:** None

**P.P.E.:** Three Hundred Ninety

The mage can protect a room of up to 30 × 30ft (9.1m × 9.1m) from mystic influence by using the sanctum invocation. The room is instantly turned into a safe haven, or sanctum, free of mystic disturbance. While inside the room, the mage can not be found by the *locate spell*, can not be seen by *second sight*, and can not be affected by *bonding magic* (but only while in the room). Even more impressive is that *animated dead* and *undead* can not enter the sanctum. *Lesser monsters* can not enter unless they save vs magic; greater beings and humans are not affected and enter at will.

## Talisman

**Range:** Varies with type of spell.

**Duration:** Talisman exists until destroyed.

**Saving Throw:** Standard

**P.P.E.:** Five Hundred

The term talisman is believed to have its roots in the Arabic language and means "to make marks like a magician." Indeed, that is what a talisman is, an extension of magic, an item that contains magic power.

A talisman can be made from almost anything, although it is most commonly designed as a medallion, necklace, mantle, pin,

charm, small statue, headdress, or hand-held symbol. A talisman is designed to perform one function only. The invocation enables the arcanist to empower an ordinary object with magic powers. The only substances which can not be used are iron and plastic, and the object can not be larger than two feet (0.6m) tall, long or wide. Once an object is transformed into a talisman, the arcanist can empower it with one magic spell. The spell can be selected from levels one through eight, excluding illusion types. Of course, to implant the spell the arcanist must already know it and it must be a *spell* invocation, not a ritual.

After its initial creation, the talisman can be used to cast its one spell for a total of three times. After all three have been cast, the object is drained. The mystic who created the talisman can replace its three exhausted spells by casting that same spell invocation combined with part of the talisman spell or ritual. The cost of the recharge is 50 P.P.E. plus the cost of the spell invocation. Note that the process must be repeated for each of the three identical spells (each at a cost of 50 P.P.E. plus the spells P.P.E. cost). Thus, to recharge all three identical spells would cost 150 P.P.E. plus. The aspect of three spells attributed to a magic item may be the source of legends that grant three wishes.

A talisman can be used for one purpose other than spells. The mage can elect to make it a potential psychic energy battery. Instead of spells, the mystic can put up to 50 P.P.E. into it initially and recharge it with 30 P.P.E. at the cost of 60. The talisman can then be used at a later time to bolster the character's normal P.P.E. reserve. A P.P.E. battery can never hold spells.

A talisman can be destroyed by smashing it. That's all there is to it. If the arcanist who created it is killed or can not be found, the talisman will be good only for whatever number of spells that are currently inside it and can *not* be recharged. Remember, only the mage who created it can recharge it.

## LEVEL FOURTEEN

### Id Barrier

**Range:** Up to 200ft (61m) away.

**Duration:** 3 minutes (12 melees) per level of experience.

**Saving Throw:** Standard, and vs horror factor.

**P.P.E.:** Six Hundred

The arcanist can erect a powerful, defensive shield of semitransparent energy. The barrier itself emanates horror, and a character must save vs *horror factor 14* to even come within 10ft of it. Those who fail to save vs horror factor can *not* pass through the barrier.

Anybody who braves the barrier must roll again; this time to save versus magic. A successful save means the character passes through the barrier with only a headache and loses one attack that melee. A failed save means the character must face an apparition of his greatest fear. The apparition is exactly like the sixth level invocation and will last as long as the barrier remains up. Only the mage who created the Id Barrier can make the apparition vanish, or cancel the barrier before its normal duration time.



## Restoration

**Range:** Touch or 3ft away (0.9m).

**Duration:** Instant/permanent

**Saving Throw:** None

**P.P.E.:** Seven Hundred Fifty

This is a powerful healing incantation. The magic will instantly, and completely, heal wounds, cuts, bruises, burns, etc., restoring full S.D.C. and hit points, while leaving only minimal scarring. It is so powerful a magic that it can heal internal organs and mend bones. Even bullets or shrapnel will magically disappear and the wounds heal. The invocation can also restore several limbs, such as a hand, arm, finger, foot, leg, etc., providing that the limb has not been severed from its body for more than 48 hours. Substitute limbs and organs can not be used. Nor can this invocation restore life or replace missing limbs or organs.

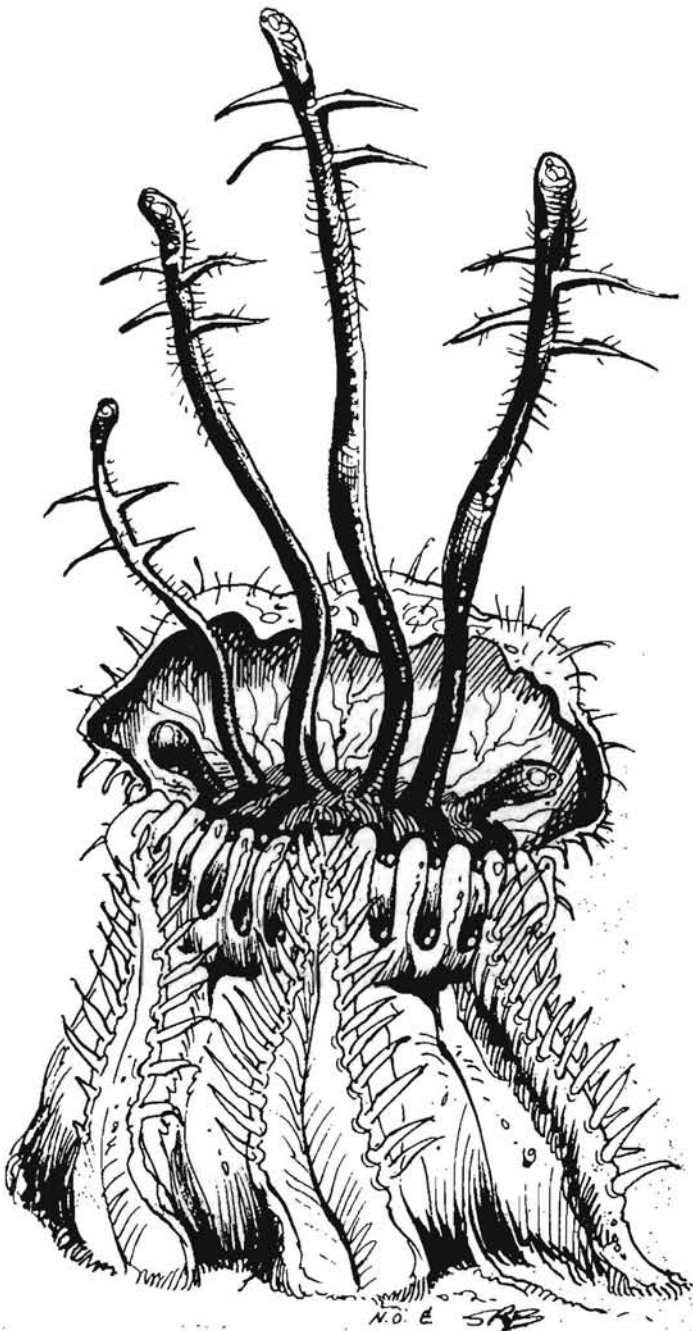

## Summon Greater Being (ritual)

**Range:** Area near summoning pentagram.

**Duration:** 1 hour, possibly more.

**Saving Throw:** None

**P.P.E.:** Eight Hundred

The invocation to summon greater beings is not the same as previous summoning circles. First of all, except for vampires, a greater supernatural being can not bring its physical form into our world except through a dimensional portal. However, these demigods can divide a part of their essence to possess the summoner or some other victim (animal or human). The possessed person or animal will have the greater being's intelligence, will, and some powers. This is where the story of demon familiars originates. For details about possession, see "greater beings" in the monster section. **Note:** The pentagram protects the mage from possession and mystic assaults; +10 to save.

Through the pentagram the summoner can communicate with the greater being to make a deal, or pact, with the powerful creature. Should terms be agreed upon, the being can provide the mage with additional P.P.E. for immediate use or cast magic upon him. (See the greater being description for details). In this way the supernatural creature can help his human partner or pawn, or send part of its intellectual essence into our world without physically entering our dimension.

## LEVEL FIFTEEN

### Dimensional Portal

**Range:** A few feet away.

**Duration:** 30 seconds (2 melees) per level of the spell caster, or one minute (4 melees) per level of experience when performed as a ritual.

**Saving Throw:** None

**P.P.E.:** One Thousand

The dimensional portal invocation opens a two-way door to another dimension. The arcanist can open a door to a specific world or randomly. This is the only way a greater being can enter into our dimension. The extreme cost in potential psychic energy (P.P.E.) makes the use of this magic very uncommon, and often forces a mage to coordinate his efforts with the flow and ebb of critical energy at ley line nexuses. Once the dimensional portal closes, the only way back in or out is to open another portal.

One of the real dangers of using this magic is that some "thing" unwanted always slips through. Roll on the following table to see what type of supernatural creature enters into our world through the portal. Roll once for every minute (4 melees) the portal is open.

1-6	One Elemental:	1-25	Fire
		26-50	Air
		51-75	Water
		76-00	Earth
7-13	1D6 UFOonauts		
14-20	One Banshee		
21-27	One Dybbuk		
28-34	One Dimensional Ghoul		
35-42	1D6 Poltergeists		



- 43-49 1D4 Gremlins
- 50-56 One Possessing Entity
- 57-64 1D4 Gargoyles
- 65-72 1D4 Poltergeists
- 73-80 One Tangler
- 81-87 One Haunting Entity
- 88-94 One Vampire
- 95-00 1D4 Dar'ota

\*Or the game master can introduce a randomly generated monster.

Once through the portal, the creature(s) is likely to take off and hide until it can get its bearings and formulate a plan of action. It will confront the summoning mage and his associates only if attacked or if it believes it can defeat him/them.

## Teleport: Superior

**Range:** Self or others; distance of 300 miles per level of experience.

**Duration:** Instant

**Saving Throw:** None

**P.P.E.:** Six Hundred

The arcanist can instantly transport himself and up to 1000lbs (450kg), per level of experience, hundreds of miles away. To teleport, the mage must have a mental picture of his destination. The best results can be achieved when the character is personally acquainted with the target destination, some place he has visited or knows well. However, locations seen in photographs or described in detail can also be reached, but there is always a chance of a miscalculation.

The mage can teleport himself alone, or other people and objects within 20ft (6.1m) of him. The total number of people and items which the mystic can teleport is limited by the amount of weight he can handle (1000lbs per level of experience).

The following tables indicate the chance of a success and the results of a failed teleport.

### Chances of a successful teleport:

1. Teleporting to a familiar location or a destination visible from one's starting point: 99%.
2. A place seen only a few times before (2-6 times): 85%.
3. A place seen in a photo (the photograph is being looked at during the moment of teleportation): 80%.
4. A place never visited before, but described in detail: 58%.

5. A place never before visited and known only by name or brief description: 20%.

### Results of an Unsuccessful Teleport

*(Roll percentile dice for random occurrences.)*

- 1-40 Appear at the wrong place. No idea of present location; 3D6 × 100 miles off course.
- 41-75 Appear at the wrong place. No idea of present location; 1D6 × 100 miles off course.
- 76-98 Teleport several feet above the ground; everybody falls, suffering 2D6 damage.
- 99-00 Teleport into an object; instant death.

## Transformation (ritual)

**Range:** Touch

**Duration:** 3 days per level of experience.

**Saving Throw:** Standard (minus) - 3 to save.

**P.P.E.:** Nine Hundred

Transformation is a powerful spell that transforms a normal human being into a grisly, demonic monster. After the transformation is completed, the pitiful creature will be a mindless slave of the mage who transformed him/her. As a monster, the character has no recollection of his/her life as a human, retains no skills, knowledge or memory, or even attributes. The "thing" will obey the mage without question and most of the time, regardless of its original alignment. However, principled, scrupulous and unprincipled characters will not kill or hurt a child, or a very dear friend or loved one. Some half remembered fragment of lost memory and emotion prevents it. Likewise, the character can not be made to commit suicide or fight to the death.

The only way to recognize the transformed character is with see aura, clairvoyance, object read or telepathy.

There are four ways to return the person to normal. 1) Wait until the duration time elapses. 2) Convince the mage who made the transformation to cancel the spell. 3) Kill the mage. 4) Remove curse has a 1-19% chance of negating the magic (roll percentile dice). The negation spell has no effect against this powerful magic.

To determine the appearance and abilities of the transformed person, roll on the random supernatural creature tables in the monster section. The transformed human will not have any spell casting powers, but may have psychic abilities.



# LEY LINES AND MAGIC PLACES

**Please Note:** Throughout this section magic is treated as a real, existing force complete with theories and historical references. This is done only for dramatic purposes. We must again express that this is a purely fictional work and has absolutely no bearing on the real world! Really!!

## THE THEORY OF VICTOR LAZLO

The following excerpt from Victor Lazlo's controversial book, **Worlds Within Worlds**, reveals the psychic investigator's revelation regarding magic and its relationship to the earth.

*"One of the civilization's greatest losses is the knowledge of earth forces. Undoubtedly, our prehistoric ancestors held at least an inkling about the power locked within Mother Earth. The Chinese may have been the first to recognize 'the power' and formulated a quasi-scientific philosophy of principles around it. But they were not alone. The megaliths of Western Europe, the Indian mounds of North and South American, the pyramids of Egypt, the giant desert carvings of Peru, and the massive stone heads of Easter Island all stand as mute sentinels to secrets lost. Each and every structure is a mystery. Marvels of construction which one must assume was beyond the capabilities of the prehistoric people who built them, one to five thousand years before mankind would develop mathematics or the written word. In most cases, modern historians are at a loss to explain why or how they were constructed. Or who were the builders. Each and every place has its own string of legends, telling of curses, ghosts, gods, demons, apparitions, strange happenings, visions and magic. Legends that often persist throughout the centuries to modern times. The same or similar tales that have continued with each new generation, despite the passage of eons and the fact that different people of different cultures, religions and origin have dominated the land.*

*"Modern man is fascinated by these shadows of our past. Is it man's unrequited curiosity that drives him to wonder about these places or is it more? Some nagging racial memory or intuitive sense that tries to alert us to the significance of the land. An attraction that draws thousands of normal people, tourists, to simply come and look and touch. Places known to have been used for magic or pagan religious ritual, which are still secretly used by practitioners of magic. Places shunned by the local inhabitants who know it to be evil, or still thought to be places of healing.*

*"One modern theory, dismissed by science, is the concept of 'ley lines.' It has been observed that the hundreds of megaliths, mounds and spiritual places often rest on a straight line from one another, like a geographic connect-a-dot pattern. Where two or more straight ley lines connect are places*

*of most notoriety such as Stonehenge. Along the path of the lines is unusually high amounts of electromagnetism. Psychic sensitives and seers claim to see and feel another energy that spirals up from the earth at these locations. Where two or more energy lines intersect the energy is strongest. As you may have already surmised, the places of intersection are marked by ancient megaliths or other similar distinctions or are infamous for supernatural phenomena.*

*"It seems that the prehistoric architects who built these impressive structures could also see or sense the energy. This would certainly explain the Celtic stone carvings of concentric circles found at hundreds of sights believed to harbor magic or supernatural forces. It may also explain the almost universal use of the image of a coiled snake to represent magic. A symbol used by the ancient Egyptians to the North American Indians. Because we know so little about prehistoric man, especially the Picts of the British Isles where megalithic structures and paranormal phenomena abounds, any postulations about these people and their holy places are almost pure conjecture. However, we do know of at least one ancient culture that had practiced earth magic, the geomancers of China.*

*"The Chinese geomancers practiced 'Feng-shui,' which, say the Chinese is, 'a thing like wind, which you can not comprehend, and like water, which you can not grasp.' Feng-Shui is a blend of science, philosophy and religion, deeply concerned with the harmony between man and nature. Its teachings profess that nature is a living entity and that the surface of the earth is a 'dim mirror' of the powers of the heavens (an aspect of Feng-shui that considers the movement and alignment of the sun, moon and stars). It decrees that man must learn to conform to nature if he is to be happy.*

*"Despite what may appear, to modern thought, a collection of superstitions to do with luck and ancestors, Feng-shui is a complex system of geomantic planning. The metaphysical science would be used to determine the most favorable geographic location, both environmentally and spiritually, to build a temple, home and entire cities. The practice dates back to at least 1000 B.C. and many insist that it is still secretly used today.*

*"According to the Chinese geomancers, landscape held good and evil forces, 'ying or yang,' and that the chi, the inner spirit, could be drained away or poisoned by a bad location. These evil locations were called 'sha,' meaning 'noxious exhalations,' and included straight ley lines of supernatural energy and places where the lines crisscrossed ('Dragon Vein'). The sha intersections were said to operate as a destructive force causing bad luck, killing livestock and attracting evil spirits. Good locations followed a winding path or 'Dragon Tracks.' The evil places were always straight lines and multiple junctions where lines of evil force crossed. One can not deny the similarity between Feng-shui and the 20th century concept of ley lines. If we compare Feng-shui and ley lines one is struck by the immediate contradiction of straight lines being evil and winding lines good. The ley lines of Europe are straight lines with the cross junctions marked with giant stones. Some of these places are considered bad luck or damned, but most were sacred or magical sights, not evil. What we have here is **not** a contradiction in understand-*



ing, but a practical, philosophical difference. The Chinese recognized the power of these places, but also appreciated that the power attracted evil and maleficent forces. The principles of Feng-shui clearly establishes this knowledge and it is here that we see to different approaches. Feng-shui sees these intersections of good and evil forces (supernatural energy) as the dark side of nature's duality. Rather than try to control or use such dangerous forces they avoided it. Feng-shui is a theological science of avoidance. A logical solution in dealing with a potentially deadly force.

"The ancient Picts of Britain, or whoever the mysterious constructors of the giant stone monuments were, took a completely different approach. They had to know about the dark side of the ley lines and junctions of even greater supernatural energy. But rather than shun these places they sought to control them and use them. The energy is the essence of what man called magic. A force, an energy, that prehistoric man recognized and the Picts, and perhaps the druids after them, learned to control! It is likely that these ancient people were the greatest men of magic to ever walk this planet. I am certain that the myth of Merlin, the magician, is a diluted tale of one or several of these prehistoric wizards. Likewise, the legends of Atlantis and Lemuria may also have its roots from the prehistoric mages of Western Europe.

"My theory is this. Ley lines are some sort of geo-psychic energy. Sorcerers throughout history mention places of power. Although these places are steeped in superstition about the supernatural and magic I believe these are only aspects or side effects that result from using the energy. After exhaustive research and studies conducted under my supervision, I have concluded that the energy is a natural force akin to what psychics recognize as magic. Magic energy is nearly identical to potential psychic energy, the natural, human energy resource responsible for psychic abilities. Psychic sensitives have felt the emanations; those with the gift to see the invisible have described seeing faint swirls of energy rising from the earth. Conventional science has corroborated that electromagnetism in these areas is unusually high with erratic increases and decreases. Unfortunately, the so-called magic energy eludes all other means of detection.

"Prehistoric wizards and priests, the metaphysical scientists of the age, recognized the geo-psychic energy (magic, if you must) as being a natural resource, neither good nor evil. Remarkably, these people developed a science to harness and use the energy. Remember, historians tell us that prehistoric man had not developed the written word nor mathematics. Yet four or five thousand years before the written word, these primitives (I laugh at that word) constructed great megaliths with individual, single cut, stone slabs 10 to 30ft (3 to 9.1m) long, all of which weighed several thousand pounds and some as heavy as 50 tons, transported them as far as 130 miles (209km), raised them upward and hefted 10 ton lintels to rest securely atop them like a giant archway. Even more astonishing is that many, like Stonehenge, clearly have astronomical calibrations accurately marking winter and summer solstice and other astronomical events. Furthermore, many of these megaliths, mounds and sacred places are in an exact straight line from each other, miles apart and very often can not be seen from one point to the other (but clearly visible from the air). These are two feats that should not be

possible without advanced mathematics and a complex understanding of astronomy; two sciences which are not known to come into existence for another five or six thousand years. Then there is the prehistoric man-made, Silbury Hill at Avebury England which stands an imposing 130ft high (39.6m) and is spread out over five and a half acres! How these monuments were constructed is as much a mystery as who. But the why is now obvious. To identify places of power, specifically nexus points, and to harness and control that energy. The aspect of an astronomical observatory was crucial in ascertaining specific times when the energy would ebb and rise with the alignment of celestial bodies. Undoubtedly the ancient wizards had great power available to them especially during certain key moments of the year. It is even possible that they used magic to erect megaliths. One myth about Stonehenge says that Merlin built it with his magic. Armed with the secrets of what I call 'geo-psychic energy' and the zen-like mastery of the mind and body required to manipulate any psychic type energy, these prehistoric people did not need a written language or the other obvious trappings of civilization. Like the Chinese, they conformed to the environment, living closely to nature, but unlike the oriental geomancers, they dared to tap directly into the energy. These masters of magic may have ruled Western Europe for eons. Whatever destroyed them is one of history's many mysteries. Disease? Invaders? Or perhaps the very forces they sought to control? Since they disappeared before the advent of written history, they and their secrets are forever lost to antiquity.

"However, our story does not end with the demise of the European wizards. Fragments of magic knowledge have trickled down throughout the ages, although much of it is buried in tons of meaningless ceremony, superstition and half truths. More important is that the ley lines and places of power still radiate with geo-psychic energy. Energy silently waiting to be called upon again.

"Magic, or more appropriately, the power of the human mind unleashed, invokes the myriad of possibilities, but there is also great danger. Ley lines and multiple cross junctions are also responsible for the existence of the supernatural forces. Although I have devoted a great deal of this theory to the ancient Chinese and Europeans, magic and the supernatural exists throughout the world. Why? Because ley lines and multiple cross junctions exist throughout the world. The Indians of North America recognized the mystic energy and the presence of supernatural evil. Places where 'spirits speak' or the abode of 'bad magic'. Places they marked with large mounds of earth, often shaped in the form of spiritual animals, or with standing stones or giant desert carvings. Others became sacred burial grounds because the Indians believed that the spirits of the dead walked that land (and in a very real sense they did). The ancient South Americans also recognized places of magic. A civilization that predates the Inca Empire is responsible for a multitude of small and humongous (500 and 600 feet long/152.5 to 183m) carvings in the Nazca desert and Peruvian mountains. The Incas, Mayans and Aztec Indians may also have had mystic knowledge. The Aztec were almost certainly necromancers. With the exception of the Aztec and a tribal shaman or medicine man, the Indians of North and South America marked places of power, but avoided them. The Australian aborigines walk along 'earth lines' that



join sacred centers and sacred rocks, said to rekindle the human spirit. Voodoo originated on the island of Haiti (located along the southern edge of the Bermuda Triangle); megalithic structures have been found off the coast of the Bimini Islands (also in the Bermuda Triangle), as well as the pyramids of South America, Egypt, and other structures found on many islands of the Pacific Ocean. Places of power scattered across the globe that have always radiated geo-psychic energy and still do.

*"The geo-psychic energy is a natural resource. A tool which can be used for either good or evil. A power that can be touched by the human mind, channeled and directed by thought. But mankind is not the only living creature that can utilize this potential energy, there is also the denizen of the supernatural. A host of inhuman creatures from other worlds. Creatures inexorably drawn to places of power like moths drawn to a flame. This is the dark side the Chinese Feng-shui warns us about. The cause of the suffocating and deadly 'sha'.*

*"Places of power, especially multiple junctions, serve as the crossroads of reality. A natural gateway to other dimensions. A doorway used by otherworldly beings to enter into our world. The demons and monsters of our myths. Maleficent forces of evil that have nothing in common with humanity. Forces which see mankind as a toy to play with or as a source of prey to feed their ravenous desires. Even a cursory examination of paranormal phenomena will instantly reveal that most occur near ley lines and ley line nexus junctions. It is at these places that the foul beings enter into our world. They linger within these areas because it is here that they are most powerful. But they are only now beginning to realize that man has changed. That humans no longer recognize them. That they can walk among the cities of man unseen and unopposed! This has made them increasingly bold. My research indicated that supernatural predators are entering our cities and towns at an alarming rate. And still nobody can seem to see it. The murderer who kills a dozen people because the neighbor's dog made him do it. Is the man insane or the victim of supernatural evil? The bag-lady who swears that she sees creatures prowling the abandoned tenement buildings of the slums; is she insane or drunk? Or has she glimpsed one of man's age-old enemies from another world? The sheriff who swears to have seen a flying saucer, the young suburban family who flees their home because it is haunted, the lunatic who pleads for somebody to remove the demons who possess him, are all mere pawns in a much deadlier game. Yet, if we will not at least consider the existence of untapped human potential, magic, or the supernatural how can we hope to survive. Our foe is already in the back yard, but we're too foolish to lock the back door."*

## A DOORWAY TO UNREALITY

The danger to mankind is not whether he uses or doesn't use potential psychic energy or places of power, but the fact that he is completely oblivious to their existence. In mankind's desperate drive to attain greatness, humans have ascribed too much value to their pitifully incomplete view of the world. Man emphatically rejects the possibility of anything that is too fanciful or too far removed from the *man-made* laws of nature. To accept the existence of mystic energy and mind power would disrupt the perception of man's carefully built structure of nature. Thus, it is

relegated to the world of myth and fairy tales. It is a perception that could very well doom humanity. For to ignore the existence of psychic energy is to ignore its inherent dangers.

Everything seems to have a balance yin-yang, good and evil, light and dark. Fire warms and helps man in countless ways, yet in an instant, it can become a devouring monster of destruction. Oil and petroleum with all their diversity poisons the water and chokes our air. Likewise, there are inherent dangers that coexist with lines of power. Dangers that exist because the energy exists. Dangers which mankind has elected to ignore.

## THE ESSENCE OF MAGIC

Victor Lazlo's theories regarding ley lines, what he called geo-psychic energy and places of power, is dead on accurate. The earth is crisscrossed in a matrix of natural energy that psychics and parapsychologists call *potential psychic energy* or by the P.P.E. acronym. The potential psychic energy is a sort of bonding energy that seems to permeate all living things and links them to the very planet or perhaps even the universe. In all likelihood it is a fundamental building block in the fabric of the universe, just as DNA or amino acid are a fundamental element of life on this planet. The energy is mysterious only because it is a x-factor that formal science does not even recognize to exist. Without the systematic methodology governed by scientific study is left to but a handful of tiny, insufficiently funded, quasi-scientific fringe groups, mystics and misdirected fanatics. Furthermore, potential psychic energy, rooted in the metaphysical, is the antipathy of science and, therefore, scorned. The power of the mind and energies related to that power is relegated to the world of science fiction.

One problem is conceptual semantics. The moment anybody mentions "magic" the door to most people's minds slams closed. Magic is a fantasy based in superstition, myth and ignorance. Or so most people would believe. The word *magic* is a misnomer that implies that its powers are not real or supersede the laws of nature. Most dictionary definitions will read something like this: "Magic: The art of producing results through the help of superhuman beings or supernatural means, the occult forces of nature, sorcery, witchcraft." In one sense it is a true definition, because historically, magic has always been linked to mystics, shamans, sorcerers, witches, demons and deities. A perception perpetuated by the modern entertainment industry. But it is also a very erroneous and misleading definition.

**Magic is the utilization of potential psychic energy (P.P.E.) in its purest form.** It exists in living creatures and exists in lines of energy which flow through our planet. It is as real as the electromagnetic energy that accompanies it and flows through man and nature. Like natural gas or uranium, the energy can be found in reservoirs within the earth. Unlike other natural resources the energy seems to replenish itself never running dry. This may be part of its cosmic nature. A power grid of natural energy that weaves throughout space and, perhaps, time and the multiverse. A grid work of energy that binds the earth to the universe in ways we do not yet understand, and to other worlds, other dimensions of reality. The ancient Chinese geomancers recognized these lines of power and called them "Dragon Paths." Pathways where the mystic energy flows and ripples like an ocean tide. Where two or more paths cross the energy is at its greatest. These are nexus points or what men of magic call "places of power." Because mankind is intrinsically linked to



the matrix he can draw upon its energy. With time and practice he can learn to use it just as we use natural gas to heat our homes.

The energy grid that crisscrossed the world does not cling to the surface of the planet, but slices through it, merging with it like a spiderweb of life-giving blood vessels. A spiderweb that is measured in light-years and ties us with the rest of the universe. Each line is a crack in the substance of what we call reality. The location where several lines of the spider's web connect is a doorway. A portal where space and time are warped and intermingled with other times, other places and other realities. The power is greatest at these junctions or nexus points. It's these places which ancient man marked with giant stone megaliths, burial mounds and pyramids. Places of power marked so that future generations would know them and beware.

Man is not alone. He never has been. Myths are rife with supernatural beings that prey upon mankind. Monsters which may be simple predators in search of food or beings which are the consummate essence of evil. Demons, earth spirits, faeries, ghosts, dragons, gods, and monsters of every variety, have been recorded throughout the ages. Supernatural beings that understood and used magic. Beings which are not born of superstition and ignorance, but very real creatures that have entered through the rifts of time and space at ley line nexus points. Creatures which prey on human beings. Monstrosities which enter unopposed because mankind denies they exist. Vile, iniquitous beings that grow ever bolder as they begin to claim man as their plaything.

These beings function on a different level than life as we know it. Creatures which are not indigenous to our planet, but alien beings who have entered into our dimension through the use of magic. Most of these beings seem to be far more attuned to potential psychic energy than humans. Many actually feed on the energy, while others use P.P.E. to wield great magic. These are the denizens of the supernatural. Exactly what these beings are or from where they come is not known. Why they come to our world is also a mystery. Almost all are intensely evil creatures; evil in a different way than humans. Like the demons and devils of mythology, these creatures appear to be diabolically evil through and through. So evil that they exude revulsion and horror. If the essence of pure, unadulterated evil could be given body, then these creatures are just that. They are not simply evil in the intellectual sense, that is to say, a mere state of mind, but the embodiment of pure wickedness, devoid of love, regret, or compassion. Insidious monsters driven to kill and torment other beings.

Supernatural monsters gain entrance to our world when massive amounts of potential psychic energy are used. This occurs during natural flare-ups of P.P.E. at places of power, the foolhardy opening of dimensional gateways through magic, and the inappropriate use of magic (especially at ley lines and places of power). Supernatural beings are most commonly found at, along or near ley lines and places of power, because of the bond between them and potential psychic energy. Consequently, the majority (approximately 74%) of supernatural, paranormal, psychic and unexplained phenomena, throughout history, has occurred near ley lines or places of power.

## PLACES OF POWER

There are five types of places of power:

*Ley Lines*

*Ley Line Nexus Points*

*Rips of Magic*

*Transitional Places of Power*

*Power Triads*

### LEY LINES

Ley lines are a matrix of natural potential psychic energy that run in straight lines across the globe. The source of the energy is unknown and apparently inexhaustible. At some places around the world the ley lines are strong enough that their energy can be seen or felt by individuals who are sensitive to psychic (or magic) emanations. It is at these locations that psychics, practitioners of magic and supernatural beings, can draw on some of its energy.

The potential psychic energy along ley lines is quite weak compared to some of the other places of power. Even still, its power will benefit anybody who is remotely attuned to psychic energy. The energy from a ley line is very subtle, acting as a battery of potential psychic energy and boosting the character's own abilities. The influence is so slight that it is imperceptible, unless one is consciously trying to sense ley line energy. Very often, the character will not even be aware that his or her abilities have been augmented. (**G.M. Note:** This means the characters will not know that a ley line is nearby and should not use their abilities any differently than usual). It may only be after the character has used his powers that he *may* realize that it was more potent than usual or that there is more psi-energy (I.S.P. and/or P.P.E.) for him to use than he thought there should be. More likely than not, the character will never notice anything at all, especially in the heat of combat or other troublesome event. Many psychics know little or nothing at all about places of power and would have no reason to suspect any outside influences over him or her. Most psychics would simply perceive an increase in their abilities as a *normal* inconsistency in their own powers; psychic phenomena tends to have its irregularities. Only an arcanist or parapsychologist are likely to recognize the influence of a ley line and even they may miss its subtle hand.

### How Ley Line Energy Affects Psychic Characters

Areas where ley lines are strong will radiate P.P.E. to about a five mile (8km) area along the path of the line. A typical ley line will run in a straight path for one to six miles (roll 1D6) and then fade, only to reappear scores or hundreds of miles away.

The energy of a ley line will continually boost the I.S.P. of a *psychic sensitive, physical psychic, latent psychic, psi-mechanic and psychic healer*, by FIVE I.S.P. This means that these characters will have an extra five I.S.P. *each melee* (sorry, not accumulative), even after their normal I.S.P. reserve has been exhausted. Why? Because they can draw on the potential psychic energy of the ley line and convert it to I.S.P. The ley line serves as a massive battery of psychic energy which all psychics can plug into.

*The Nega-Psychic's* powers are his natural defense, thus add a bonus of +2 to ALL savings throws when under the influence of a ley line.

*The Natural or Genius P.C.C.* enjoys a +2% skill bonus or.





*all skills.* Physically oriented characters of this P.C.C. do not get skill bonuses, but, instead, get a +1 to strike, parry and dodge.

*The Parapsychologist P.C.C.* gets a +3% skill bonus on all skills related to parapsychology only!

*The Arcanist/Mage* can draw on an extra FIVE P.P.E. per melee (not accumulative) to use in magic.

*Supernatural creatures* and some *magic artifacts* can also use ley line energy. They either get FIVE I.S.P. per melee or FIVE P.P.E. (for magic) per melee, just like the psychic or arcanist. **Note:** The supernatural creature or artifact can draw only on one or the other, not both I.S.P. and P.P.E.

## LEY LINE NEXUS POINTS

The junction point where two or more ley lines cross each other is the most potentially powerful source of psychic energy. It is the nexus point of several ley lines which is most commonly marked by ancient megaliths, pyramids, burial mounds and standing stones. Stonehenge is the most renowned of the megalithic structures, but there are dozens of similar places scattered throughout the British Isles, Scotland, Ireland, France and Malta. Pyramids, mounds, standing stones and giant carvings of animal effigies are found throughout the world. Nine out of

ten times the prehistoric structure marks a ley line nexus of potential psychic energy. A location the users of magic call "a place of power."

A place of power radiates raw potential psychic energy (P.P.E.) far greater than any one ley line. All psychics can tap into and use the P.P.E. much like they can a ley line, but with much more impressive results. Generally, a psychic can perform his abilities with enhanced strength and less effort. However, the real potential of a power nexus can only be realized by an arcanist/mage.

### How Ley Line Nexus Points (Junctions) Affect Psychic Characters

Places of power always generate potential psychic energy. However, there are periods when the level of energy increases dramatically. The most notable period of increased energy is during a planetary alignment and during the seasonal equinox and solstice. Small increases also occur at midday (noon) and midnight. The increases along ley *lines*, during these periods, are insignificant, so there is no perceivable change in its influence on psychic individuals. On the other hand, the influence at the *nexus* center is staggering.

**Normally**, during low energy ebb, *the psychic sensitive, phys-*



*ical psychic, latent psychic, psi-mechanic, and psychic healer*, will enjoy the following benefits, as long as they are within 80ft (24.4m) of the ley line *nexus*. 1) Provides an additional 8 I.S.P. per melee (non-accumulative). 2) Doubles the usual duration of the psychic affect/influence. 3) Doubles the usual damage (if any).

*The Nega-Psychic's* natural psychic defenses increase, thus add +3 to ALL savings throws. At a nexus the character's negative influence also increases. The negative force continually radiated by the character is doubled, negating eight magic P.P.E. for every one of the nega-psychic's P.P.E., and the range of effect is 20ft.

*The Natural or Genius P.C.C.* enjoys a +4% skill bonus on all skills. Physically oriented characters of this P.C.C. get a bonus of +1 to strike, +2 to parry and +2 to dodge, but no skill bonuses.

*The Parapsychologist* gets a +5% skill bonus added to all skills related to parapsychology only.

*The Arcanist/Mage* can draw on an extra TEN P.P.E. per melee for magic (not accumulative).

*Supernatural creatures* and some magic artifacts can also use the energy at the places of power. They either get EIGHT I.S.P. per melee for psychic powers or TEN P.P.E. per melee for magic. **Note:** Supernatural creatures or artifacts can draw only on one or the other, not both I.S.P. and P.P.E.

**AT NOON (Midday) AND AT MIDNIGHT**, the energy tide of the nexus point rises. The high energy period lasts for one hour, from 12 o'clock (noon) till 1:00 p.m., or 12:00 a.m. (midnight) till 1:00 a.m. This means that, in addition to the normal psychic benefits at a ley line *nexus* (just described), the character's abilities are even further enhanced.

*The Psychic Sensitive, Physical Psychic, Latent Psychic, Psi-Mechanic and Psychic Healer*, can each use their already enhanced psychic abilities at HALF the usual I.S.P. cost.

*The Nega-Psychic, Natural and Parapsychologist* are unchanged (see ley line nexus at normal energy level).

*The Arcanist/Mage's* personal P.P.E. level is temporarily doubled during that one hour period. However, once all his/her P.P.E. is spent on magic, only the perpetual 10 P.P.E. is available to draw on.

*Supernatural creatures* and some magic artifacts will also use the increased energy of the witching hour (midnight to one in the morning) or high noon. Creatures of predominately psychic ability will have the same increased abilities as the human psychic characters. While the users of the mystic arts will have the increased magic P.P.E. as the arcanist.

**THE EQUINOX (vernal and autumnal)** are *two* times each year when the sun crosses the equator and day and night are of equal length (usually around March 21st and September 23rd). During the *daylight hours* of the **vernal equinox** (spring) and during the nighttime hours of the **autumnal equinox**, the ley line nexus' are alive with energy. *All characters'* P.P.E. reserves are temporarily doubled, excluding the *arcanist/mage*, whose P.P.E. is tripled.

*The Psychic Sensitive, Physical Psychic, Latent Psychic and Psychic Healer*, can each use their already enhanced psi-abilities (see ley line nexus at *normal* energy level) at HALF the usual

I.S.P. cost, plus a one time bonus of 20 I.S.P. The 20 I.S.P. bonus is gone at the end of daylight during the vernal equinox and at the end of night (darkness) during the autumnal equinox.

*The Nega-Psychics', Naturals'/Genius' and Parapsychologists'* abilities during an equinox are identical to those gained at noon and midnight. Nothing more.

*The Psi-Mechanic* has a unique opportunity to use his temporarily increased P.P.E. to build, or begin to build, a new psi-machine. Since the total time period available during an equinox is 12 hours, it is likely that the psi-mechanic will have to wait and build his machine during several equinox and/or solstice periods. Even if the character has no knowledge of ley lines or places of power, he will sense the extra power inside himself and intuitively know that he has the power and insight to create new psi-machines. Note that this instinctive sense will occur only if the psi-mechanic is actually present at a ley line junction during an equinox (or solstice). Of course, an Arcanist/Mage or Parapsychologist knowledgeable in ley lines could inform the Psi-Mechanic of this unique opportunity if the character so desires. The rest will come naturally.

*The Arcanist/Mage* has the best opportunity to use his abilities. The practitioner of magic will have his personal P.P.E. level tripled at the beginning of the equinox, plus the 10 magic P.P.E. available each melee (non-accumulative). However, once all his/her P.P.E. is spent on magic, only the perpetual 10 P.P.E. is available to draw on.

*Supernatural creatures* and some artifacts can also use the potential psychic energy. As usual, they are under the same restrictions as their human, psychic or magic counterparts.

**SOLSTICE (summer and winter)** occurs two times a year when the sun is farthest from the Earth's equator (around June 21st and December 21st) and the two shortest days of sunlight sends ley line junctions aboil with energy. The bonus power(s) are identical to the spring and winter *equinox*, with two notable exceptions: 1) An incredible flare of potential psychic energy erupts during the first few minutes of dawn (lasting a total of five minutes). During that brief period a prepared arcanist/mage can use that energy to perform incredible magic. A total of 200 P.P.E. are available, but only during those first five minutes of the day's new light. 2) A similar, but smaller, flare occurs at the moment the sun completely sets. During those first five minutes a total of 100 P.P.E. are available for mystic purposes.

**Note:** The two energy flares provide a momentary P.P.E. energy surge that must be used immediately (within 5 minutes), if it is to be used at all. The P.P.E. can NOT be stored and saved for use at some later time; it's now or never.

**A LUNAR ECLIPSE** happens when the Earth is in a *straight line* between the sun and the moon and the shadow of the Earth covers the moon. A lunar eclipse occurs once a year and lasts about an hour and a half. During that hour and a half (90 minutes) the ley line nexus seethes with power. *All characters'* P.P.E. reserves are temporarily tripled (except the Arcanist).

*The Psychic Sensitive, Physical Psychic, Latent Psychic, Psi-Mechanic and Psychic Healer*, will enjoy the following benefits, as long as they are within 100ft (30.5m) of the ley line *nexus*: 1) Provides an additional 10 I.S.P. per melee (non-accumulative). 2) Doubles the usual duration of the psychic affect/influence. 3) Doubles the usual damage, if any. 4) The use of a psychic ability *costs half* the usual I.S.P. (but only during the



90 minutes of the eclipse). **5) Bonuses:** +1 to save vs possession and any form of mind control. Also adds +10% to psychic abilities with skill levels like clairvoyance and divination.

*The Nega-Psychic's* natural psychic defenses increase, thus *double* ALL savings throws. The negative force which the character generates is also vastly increased, affecting a 30ft (9.1m) area around him. Each one of the character's nega-P.P.E. points will negate 10 points of magic P.P.E. and/or a penalty of -10% on psychic abilities that have a skill success ratio, such as object read, clairvoyance or divination. Remember, the nega-psychic's P.P.E. base is also doubled (as are all characters') for the 90 minutes of the eclipse.

*The Natural or Genius* P.P.C. who is scholastically oriented enjoys a +6% skill bonus on all skills, including secondary, plus a +1 to parry and dodge. *Physically oriented* Naturals get a bonus of +10 S.D.C., +2 to strike, parry, dodge and roll with a punch or fall, but no skill bonuses.

*The Parapsychologist* gets a +5% skill bonus added to all skills related to parapsychology only. Plus bonuses of +1 to save vs magic, psychic attack and possession.

*The Arcanist/Mage* has his personal P.P.E. quadrupled as soon as he arrives at a ley line nexus during a lunar eclipse. In addition, the man of magic can draw on a total of 300 P.P.E. at any time during the eclipse period (90 minutes). However, once all his/her available P.P.E. is spent on magic, only the perpetual 10 P.P.E. per melee is available to draw upon. Remember, the ten P.P.E. is not accumulative.

*Supernatural creatures* and some artifacts can also use the potential psychic energy. As usual, they are under the same restrictions as their human, psychic or mystic counterparts. There is also a 25% chance that 1D4 supernatural beings can enter into our world at each nexus point during a Lunar Eclipse.

**A PARTIAL SOLAR ECLIPSE** is the second most powerful moment possible at a ley line nexus. This time it is the moon which is in a straight line between the Earth and the sun, but is too far away from the Earth to completely obscure the sun. A partial solar eclipse is an *annual* event which has a great impact on places of power. The effect it has on individuals present at a ley line nexus (junction) is identical to the lunar eclipse, but *lasts a mere 10 minutes!*

There is one big difference. The potential psychic energy released during those ten minutes is an incredible 600 P.P.E. points. With this much energy a mystic can attempt to open a gateway to other dimensions and/or summon and control supernatural beings. There is also a 50% chance that 1D6 supernatural creatures can enter into our world at each nexus point during a partial eclipse.

**A TOTAL ECLIPSE OF THE SUN** occurs when the moon passes in front of the sun and Earth, but is close enough to the Earth that the sun is briefly blocked from sight. Only a radiant ring of light, emanating from behind the silhouetted moon, can be seen of the sun. As one might expect, this rare solar event (occurs about once every 10 years) has a profound effect on all places of power. A total solar eclipse is visible from only a small section of the planet. To the rest of the world, the eclipse appears as a partial solar eclipse. This means that most ley line nexus' will react exactly as they do during an annual, partial solar eclipse. However, at ley line nexuses located at the part of the planet where a total solar eclipse is visible, the available potential

psychic energy reaches its maximum capabilities. A total eclipse will last 2 to 8 minutes (roll 2D4). All characters' personal P.P.E. is quadrupled.

*The Psychic Sensitive, Physical Psychic, Latent Psychic, Psi-Mechanic, and Psychic Healer*, will enjoy the following benefits, as long as they are within 200ft (61m) of a nexus center: **1)** Provides an additional 10 I.S.P. per melee (non-accumulative) for the duration of the eclipse (roll 2D4 minutes). **2)** Doubles the usual duration of the psychic effect/influence. **3) Doubles the usual damage.** **4)** Doubles the usual range. **5)** The use of a psychic ability costs one third the usual I.S.P. (but only during the 2 to 8 minutes of the eclipse). **6) Bonuses:** +1 to save vs possession and any psychic attack. Also add +20% to psychic abilities with skill levels like clairvoyance and object read. **7)** Can draw on an additional 20 I.S.P. per melee (non-accumulative) for the duration of the eclipse.

*The Nega-Psychic's* natural psychic defenses are increased; *double* ALL savings throws, plus add +3 to save vs magic and +3 to save vs possession. The negative energy radiated by the nega-psychic, will interfere with ALL psychic attacks directed at the nega-psychic reducing the damage and effect to one third normal. Each of the character's nega-P.P.E. points will negate 20 points of magic P.P.E. and/or a penalty of -10% on all psychic abilities that have a skill success ratio, such as object read or clairvoyance. Remember, the total eclipse temporarily quadruples the character's P.P.E.

*The Natural or Genius* character who is scholastically oriented enjoys a +6% skill bonus on all skills, including secondary. Plus, a bonus of +1 to strike, parry and dodge. *Physically oriented* Naturals get a bonus of +20 S.D.C., +2 to strike, parry, dodge and roll with a punch or fall, one extra attack per melee (hand to hand), but no skill bonus.

*The Parapsychologist* gets a +5% skill bonus added to all skills related to parapsychology only. Plus bonuses of +2 to save vs magic, +2 to save vs psychic attack and +2 to save vs possession.

*The Arcanist/Mage* has his personal P.P.E. magnified by TEN times. Plus there is a total of 1200 P.P.E. available for magic during the eclipse period (2D4 minutes). Such vast potential psychic energy can be used to unleash great magic or open a dimensional gateway.

*Supernatural creatures* and some artifacts can also use the potential psychic energy. As usual, they are under the same restrictions as their human, psychic or mystic, counterparts. There is also a 70% likelihood that 3D6 miscellaneous, supernatural creatures will be able to enter into our world, during the eclipse, at all nexus points under the affect of the *total* eclipse.

**NOTE:** The special bonuses, increased I.S.P., increased personal P.P.E., extra magic P.P.E., or I.S.P. gained from a ley line nexus point, will continue only for the brief time of the energy surge. In the case of an equinox or solstice the energy at the nexus lasts for half a day, while the massive amount of energy caused by an eclipse lasts only a few minutes. In *all* cases, once the energy effect stops, all bonuses and extra P.P.E. and I.S.P. are gone; returned to normal. *See nexus points during normal low energy.*

**OTHER PERIODS** of potential psychic energy surges occur at ley line nexus points during other planetary alignments. Three or four planets (including Earth) aligned in a straight line with



each other will create an effect identical to a lunar eclipse. An alignment of five or more is equal to a partial solar eclipse.

### SUMMARY OF PEAK TIMES OF ENERGY AT A LEY LINE NEXUS (JUNCTION)

Noon — Lasts one hour.

Midnight — Lasts one hour.

Vernal Equinox (spring) — Lasts about 12 hours.

Autumnal Equinox (fall) — Lasts about 12 hours.

Summer Solstice — Lasts about 9 hours.

Winter Solstice — Lasts about 9 hours.

Lunar Eclipse — Lasts about 90 minutes.

Partial Solar Eclipse — Lasts about 10 minutes.

Total Solar Eclipse — Lasts 2 to 8 minutes.

Planetary alignments\* — Lasts 40 to 120 minutes (3D4 × 10).

\*Also see the *normal* level of energy at a ley line nexus.

### RIPS OF MAGIC

Periodically, tiny pinholes of mystic energy rips through the fabric of reality. From these holes radiates potential psychic energy, like a tiny fragment of ley line. The rip, or hole, is always a comparatively small area, affecting about a four to sixteen foot (1.2 to 4.9m) area (roll 4D4 feet). Most (71%) can be found along a ley line pattern, although they may exist thousands of miles away from any known line of power.

Rips of magic, like ley lines, are batteries of potential psychic energy that can be knowingly or inadvertently tapped by psychics and practitioners of magic. The power/abilities the rip provides are *identical to ley lines* (not a nexus), but its area of influence is limited to its tiny radius of four to sixteen feet (G.M., roll 4D4 to determine the size of the hole). To draw on the P.P.E. battery a character must actually stand in the radius of the rip. Standing even a mere foot away will not enable the psychic character to use the hole's energy.

Supernatural creatures are, of course, drawn to rips of magic, especially *entities* which must feed on potential psychic energy. Victor Lazlo made this observation: *"I have noticed the presence of an anomaly that bears a striking resemblance to the power of ley lines and geo-psychic energy at several haunted places. The anomaly is a small area of geo-psychic force that radiates from an area of less than five meters (16ft). At every haunting where an anomaly has been found, there have been poltergeists and trapped entities in addition to the haunting entity. In such cases, the anomaly can be identified by a psychic sensitive as a ley line (which it is not, exactly) or area of magic energy. A non-sensitive can locate the anomaly because the area can be physically felt as the infamous 'cold spot' and is almost always the heart of the supernatural activity at a haunting. After cross-referencing several sources, I have come to recognize that a substantial number of haunted houses and places seem to show the existence of the geo-psychic anomaly. My guess is that as many as 40% of all hauntings are caused or stimulated by the presence of the miniature ley line of geo-psychic energy. If the weird occurrence is a permanent emanation of P.P.E., like a ley line, then those particular places may always attract poltergeists and other entities. We should investigate this further."* A quote taken from a letter from Victor Lazlo to a one-time colleague.

All rips of magic are not permanent as Professor Lazlo feared they might be. Most, about 75%, will suddenly appear, remain

for several decades, and then close up and disappear. These holes of energy are not so much rips as they are temporary leaks along ley lines. Picture a weave of fabric pulled very tightly. At weak points the fabric will separate a little to reveal a pin hole. It is through this pinhole in the fabric of space and time that the potential psychic energy of a larger ley line escapes. However, if the pull on the fabric is reduced the weave will sag back together, closing the hole. What causes the tension that opens a hole of potential psychic energy is not known, although one can safely assume that it is of cosmic origin.

A typical rip of magic will appear and remain active for decades; roll 3D6 × 10 years. There is also a 60% chance that the hole will appear again about every hundred years after its closure. A small percentage of rips, about 18%, are as permanent as ley lines.

**NOTE:** *Remember*, a rip or hole of magic energy (P.P.E.) is identical to a ley line in power and boosted abilities it can provide to psychic and magic characters. The only difference is that to draw on its energy the individual(s) must stand directly in the small area of the hole (4D4ft). The energy of a rip can not be used beyond the perimeter of the hole itself.

### TRANSITIONAL PLACES OF POWER

The fourth type of place of power is an *irregularity* that sporadically occurs along a ley line pattern. From time to time, the potential psychic energy within the overall ley line pattern builds and surges with an overabundance of energy. When this occurs the energy must be released, and there is an eruption of psychic energy somewhere within the spider web of ley lines. Oddly enough, the sudden release of P.P.E. rarely occurs at a ley line nexus, nor at known places where ley line energy is at its strongest. Instead, the eruption happens at a completely random point within the ley line web.

Most of the energy eruptions are completely random occurrences, taking place anywhere at any time. A few, however, will occur at the *same* general area at *regular intervals*, appearing, disappearing and reappearing, for a short while, every 20 years, or 40 years, or 100 years, or 7 years, or whatever. It is the latter which is sometimes recognized and taken advantage of by practitioners of magic.

The disruptive nature of the energy release means that the occurrence is like a volcano, with several eruptions over a short period to let off the turbulent, excess energy. Each time the eruption occurs, the P.P.E. will be available for mystic use or a dimensional doorway swings open. In the case of regular interval-type phenomena, the number of eruptions (waves of available energy) will be the same every few decades it occurs. Likewise, the same type of odd events or supernatural menace(s) will plague the area during every period that the energy surge happens. This will create a history of supernatural events that might be uncovered by an arcanist or investigative team.

**Game Masters** can use the following tables to create the happenings of a transitional place of power or use them as a guideline to construct your own specific events. Note that such an occurrence is fairly rare, happening only once every few years, but may occur at a half dozen different locations simultaneously.



## ONE: The Effects and Degree of Energy Released

- 1-17 Equal to an equinox each time the energy eruption occurs.
- 18-34 Equal to a lunar eclipse per each eruption.
- 35-50 Equal to a partial solar eclipse per each eruption.
- 51-66 A dimensional doorway opens to release some sort of supernatural evil (2D4 lesser supernatural creatures). A knowledgeable practitioner of magic can seize this opportunity to summon several specific, supernatural creatures through the dimensional door. The dimensional rift will open each time there is an energy eruption. The rift will remain open for 6D6 minutes at a time.
- 67-83 Equal to a total solar eclipse per each eruption.
- 84-00 A dimensional doorway opens\* to release a major supernatural force of evil. It will wreak havoc until the last eruption opens the dimensional door for the last time and then it will go back to its own dimension. (In the case of regular interval occurrences the creature will wait until the cycle reoccurs, returning every time to cause death and sorrow.) \***Game Masters** can *opt* to change this and instead use the dimensional rift as a two-way portal that will enable the characters to enter into another dimension. *See the "Game Master's Option" in the Triad section that follows for suggestions on dimensional travel.*

## TWO: The Overall Period of the Energy Surges

- 1-14 24 hours
- 15-30 Two days
- 31-44 Four days
- 45-58 Seven days
- 59-72 Nine days
- 73-86 Fourteen days
- 87-00 Twenty-one days

**THREE: The Number of Energy Eruptions During the Overall Period.** (Note: The first begins the period, the last ends it, all others occur within the overall period of occurrences.)

- 1-20 Two eruptions
- 21-40 Three eruptions
- 41-60 Four eruptions
- 61-80 Five eruptions
- 81-00 Six eruptions

**FOUR (optional):** The location is a site of *regular intervals* of P.P.E. surges and eruptions. Roll to determine the interval of years between each incident.

- 1-16 Seven years
- 17-32 Nine years
- 33-48 Twenty years
- 49-65 Thirty years
- 66-81 Forty years
- 82-00 Forty + 6D6 years

## POWER TRIADS

Power Triads are, without question, the most innocuous in appearance and the most spectacular in effect. There are six triads; five located over oceans where warm waters flow to meet cold and a sixth encompassing the Mediterranean Sea. The best known of these six triads lies off the coast of Miami, Florida, stretches southeast to Puerto Rico and north to Bermuda; it is

the infamous **Bermuda Triangle**. Also known as the Devil's Triangle, this vast area of Atlantic Ocean has been the site of countless tales of ghost ships, sea monsters, apparitions, flying saucers and unexplained disappearances for centuries. The most famous case is the disappearance of an entire squad of *five Avenger Torpedo Bombers* on December 5, 1945.

Flight 19 was lead by veteran flight instructor, Lt. Charles Taylor, on a routine navigational training exercise at mid-afternoon. The flight would never return. What happened to the five fighter planes and 13 crewmen is a mystery. All that remains is a transcript of a garbled radio message intercepted at 3:40 p.m. over Ft. Lauderdale: "What is your trouble?" asked another pilot a few miles away. "Both of my compasses are out and I am trying to find Ft. Lauderdale," replied instructor Taylor. For the next 45 minutes the other pilot tried to talk Taylor and his four companion planes back to Ft. Lauderdale. The pilot tried to orient Taylor and his men with the position of the sun, yet though it was a clear day, *none* of the five planes could find the sun. Then transmission went dead. The ground station at Fort Everglades had established intermittent contact with Flight 19, during which they spoke of a sunless, white sky and a complete loss of direction. The five pilots could not see the sun, land or water. Finally, at 5:15, Lt. Taylor's last radio transmission was received: "We'll fly west until we hit the beach, or run out of gas."

Authorities at Ft. Lauderdale air base ordered an immediate search. A Mariner Flying Boat, with another 13 man crew, was in the air within minutes. A short time later, radio contact was lost and the Flying Boat joined Flight 19 in oblivion. Despite the extensive search which followed, none of the airplanes, nor crewmen, nor any trace of wreckage, was found. Bad weather, perhaps a sudden squall (not that any such storm is *known* to have existed that day), is the official solution to the disappearances.

If the disappearance of Flight 19 was one random event, then a sudden storm might be the logical answer. However, boats have been found completely intact and sailable, with no sign of trouble except that the crew is simply gone. Weird lights, ghosts, sea serpents, UFOs and other supernatural occurrences have been recorded for generations. Again we find the handiwork of prehistoric mages marking a place on **Bimini Island** as a place of magic power. The structure is a reversed "J" shape, built of 15 ton, stone blocks and measuring approximately 1970ft (600m). Today the stone marker is nestled below 20ft (6.1m) of Atlantic water in a fishing reef. As usual, its builders are an unknown, prehistoric race. The location of Bimini Island is the western point of the Bermuda Triangle. About a 150 miles further west is Miami, Florida, following the triangle southward is Haiti, the home of Voodoo magic, and the southern tip of the Bermuda Triangle.

Farther south is another Triad, the **South American Triangle** located a few hundred miles off the coast of Argentina and Uruguay. Almost directly east of it is the **African Triangle** located below Madagascar and off the coast of Mozambique, South Africa. Across from it is the **South Pacific Triangle** which stretches from the northern tip of Tasmania and is nestled between Australia and New Zealand. About 2000 miles above Australia is the **Japanese Triangle** which starts at Guam, runs northeast to Wake Island and north to about 250 miles off the coast of Honshu, Japan. The last Triad is the Mediterranean



Triangle, which covers the entire Mediterranean Sea with its southern tip covering the Nile Delta, the site of the great pyramid of Giza. (See map for specific location).

Each of these so-called "Devils Triangles" are located in an almost straight line from each other (only the Mediterranean Triangle is slightly out of alignment). Each sits off the eastern coast of a major continent (again, only the Mediterranean Triangle breaks the pattern, surrounded by land). Three exist on each side of the equator and each area is known for its rough waters and violent storms. The Bermuda Triangle, African Triangle, South Pacific Triangle, and especially the Japanese Triad, are all in waters known for tropical cyclones. Are these storms just because of the cold and warm waters and wind currents that merge there, or are the storms rooted in something a little more cosmic? Although the Bermuda Triangle is the most publicized for its odd occurrences, each of the other five have equally as vast and nearly identical histories of weird happenings.

Each of the six triads are formed by ley lines that connect to form a triangle. The triangular shape creates a self-contained energy vortex unlike any other place of power. The energy vortex is actually a rip in the fabric of space and time. A *wandering* door to other dimensions contained within the triangle of ley lines. In its least dangerous form, the dimensional door is closed; a tiny electromagnetic anomaly harmlessly drifting about within the perimeters of the triangle. However, the doorway expands and swings open several times a year. The extradimensional flare-ups occur during or near the spring and fall equinox, the summer and winter solstice, and during celestial events, such as eclipses and planetary alignments. The doorway to other worlds also opens randomly, perhaps the result of cosmic phenomena in some other dimension. The duration of the random manifestations are usually short, rarely lasting more than a few hours (roll 1D6 hours). However, the occurrence of a lunar or partial eclipse, as well as the seasonal power surges, will fling the dimensional door wide open for days at a time (roll 2D6 days). During these occurrences, the tiny magnetic anomaly swells and grows into a vortex of potential psychic energy and other cosmic forces. In protest, the ocean winds and waters instantly whip themselves into a furious, unnatural storm. The vortex and the accompanying storm happen so quickly that an airplane or ocean vessel would be engulfed before they knew what hit them. As the rip in space and time grows ever larger so does the magnitude of the storm. Thunder, lightning, clashing winds, and cascading rain, churn up the waves and atmosphere alike, but there is always an area of least resistance. A pathway that somehow seems less turbulent. A pathway that ultimately leads to the now enormous dimensional doorway, gaping wide like a monstrous maw, waiting to devour its prey. The dimensional rift can encompass several thousand feet (3D4 × 1000ft), although this is quite small when compared to the thousands of square miles enclosed by the ley line triangle. But it is large enough to easily swallow an unsuspecting ocean liner or passenger jet.

The vortex, large or small, is always in motion, so it will *never* be found in the exact same place at any given time. As the harmless electromagnetic anomaly, it slowly bobs about the triangle's radius, while the full size dimensional vortex is hurled through the triangle by the force of the storm that encircles it. Anything caught in the path of the traveling dimensional rift will be hurled into another dimension (or attacked by "things"

that have come into our world through the rift).

A total solar eclipse is even more spectacular, rending space and time like buck-shot fired through a bed sheet hung out to dry. The usual vortex swells open, two times larger than usual, accompanied by several dozen, smaller (2D4 × 100ft) dimensional rifts/storms scattered throughout the triangle. The major vortex will roar through the triangle for hours (roll 2D6 hours), then vanish, taking the smaller ones with it. But this is not the end of the phenomenon. Every day for the next several weeks (roll 2D4 weeks) a major dimensional rift will spring to life, always accompanied by an entourage of smaller dimensional passages (roll 4D6). After a few hours, all will vanish as quickly as they came. Since violent storms are common to the waters of the six triangles, and the odds of a chance encounter are actually quite slim (3%), nobody notices anything unusual.

*There are several constant variables that occur whenever caught in a dimensional vortex.* As the storm approaches, radio wave distortion increases. The storm/vortex will move at speeds of 35 to 70mph (54 to 112km) and may move *against* the natural wind. Upon immediately entering the edge of the storm, radio wave distortion will render the radio useless. All other instruments, including wristwatches, will go crazy, spin wildly, run counterclockwise, or stop dead. No amount of tampering will get the radio or instruments to function properly. The compass will spin counterclockwise, until out of the storm. Passengers completely lose all sense of direction. Those aboard an airplane will even lose the sense of where's up and down. The vessel will be buffeted by waves of turbulence that seem to be tearing the vessel apart (this is an illusion, for the real damage is usually insignificant). The sky will be a dark grey-green (or sometimes orange-red), interrupted by great, billowing, grey/black clouds and white flashes of what resembles heat lightning. Some of the clouds may be of unusual shapes, including long cylindrical clouds running both horizontally and vertically (up and down like a pencil standing on end). Time is frequently distorted; what seems to be hours may turn out to be minutes, or what seems to be minutes is hours or even days. Passage *through* the dimensional rift is always accompanied by the sensation of floating, completely engulfed, by swirling white clouds for several minutes. Then, the storm again for another few minutes, followed by riding out of the storm into a calm, peaceful sky/waters. The storm (and the dimensional rift) can be seen moving off into the distance. **GAME MASTER'S NOTE:** A *close encounter* with a dimensional vortex does NOT mean the characters will get pulled into another dimension. Often the experience will be the terror of riding out the storm, time distortion, space warp, or combat with a supernatural creature. *See the Random Encounter Table and suggestions that follow shortly.*

The real danger is not being accidentally sucked into the dimensional vortex, but that horribly evil, supernatural beings from other realms of reality can enter into our world. Creatures that are attracted by potential psychic energy and that feed on it or other living creatures, such as humans. Alien things that belong on some distant world. It is these horrific creatures that are responsible for stories of sea serpents, ghosts, ghost ships, demons, flying saucers and other unnatural occurrences, in the six triangles. Creatures just as responsible for disappearances and death than a wandering dimensional hole in space and time, or even tropical storms. Each time a dimensional vortex appears a certain number of beings slip through into our world. Some



die in the tempest of the storm, others perish in the merciless ocean waters, but others survive. They survive to prey on mankind; first dispersing to ley lines, then into the deepest confines of human civilization. They are the true dangers because mankind is blind to their existence and unprepared to combat them. Those individuals cursed with the insight that the demons of our past are real and very much with us are terribly few and frequently unprepared for battle.

Fortunately, for mankind, the most powerful, the demonic demigods of ancient man, can seldom enter through the rifts of the triads. Instead, it is the more common, lesser beings that slip through the turbulent dimensional door. The most common are entities of all kinds, UFO-nauts, gremlins and the lesser predatory type creatures.

## TRIAD RANDOM ENCOUNTER TABLES

### Roll Percentile Dice

The following table is a selection of possible events that can occur near a dimensional rift/vortex (within five miles/8km), or if caught in the storm that encompasses the vortex. Suggestions for dimensional travel are also provided.

- 1-9** 1D6 Poltergeist cause mischief for several minutes (roll 3D4 minutes). *See Entities: Poltergeist in the monster section for details.*
- 10-20** **Flying Saucers:** The character(s) see 1D6 flying saucers, darting about playfully, less than a mile away (1.6km). Suddenly, the glowing disc(s) zooms toward the character(s) and stops within 300ft (91.5m). The disc will linger for 3D6 minutes, hovering and performing aerial acrobatics, and may pick up a character for psychic examination. *See the UFO-naut in the monster section for details.*
- 21-29** **Lost at Sea:** For what seems to be an eternity (roll 2D8 hours), the character(s) is lost at sea. All instruments go dead, including the radio. The water and/or air is turbulent and foggy. Sense of direction is distorted and uncertain. The sounds of a storm in the near distance can be heard, but not seen. Unexpectedly, everything clears up, the instruments are all working perfectly, and the weather is beautiful. A quick radio check confirms that the characters are at exactly the same location they were at before the fog rolled in and that no time has elapsed. Time simply became nonexistent. **Game Master Option:** If you wish, the characters can be bothered by some lesser type, supernatural being, like a poltergeist, ghost, seaweed monster (an entity), gremlins, or similar, during the time they are lost.
- 30-38** **A Giant, Hungry Octopus** or Squid-like monster attacks the boat. (Roll again if in an airplane.) The damn "thing" is relentless and will fight to the death. The octopus creature: Hit Points — 100, S.D.C. — 50 (The G.M. may want to double the S.D.C. and/or hit points if the characters consist of a larger group with a lot of firepower.)  
**Size:** 50ft (15.2m)  
**Horror Factor:** 16  
**Alignment:** Miscreant  
**Animal Intelligence**  
**Attacks Per Melee:** 6; lashes out with tentacles, in-

flicting 2D6 damage per each hit. The bite from its beak-like mouth does 3D6 damage.

**Notes:** If snared by a tentacle, the person will suffer 1D6 damage and will be unable to pull free. However, inflicting 15 points of damage to that tentacle will cause it to let go. Otherwise, it will toss its victim into its mouth within four melees. Fire does normal damage to the beast. The creature has no bonuses to strike, dodge or damage.

- 39-47** **Engulfed by a Strange Cloud:** A storm rages a mere half mile away (0.8km). The sky is an unusual color (G.M. choice: green, red, violet, etc.). A very weird, tubular cloud is moving toward the character's vessel (airplane, or boat) and may be moving against the wind (Horror Factor: 14). Regardless of the vessel's speed, the massive tubular cloud, five times larger than the vessel, will catch and engulf it within 2D6 melees. Yes, this includes boats.

Being engulfed by the cloud will create an instant nighttime effect. Artificial lights still work, but the radio and all sensory equipment go dead, while the compass spins wildly counterclockwise. There is a strange calm inside the cloud. No wind or turbulence of any kind; no outside noise, just a strange quietness. Psychic Sensitives will sense no evil, nor presence, but will sense incredible magic energy. Arcanists and characters with a great deal of P.P.E. (10 or higher) will immediately feel dizzy and nauseous. Other characters will feel an odd, tingling sensation. Anybody who attempts to use magic will pass out, remaining unconscious until the cloud is gone. Magic artifacts will not function. Jumping ship will hurl the character into an endless void. The cloud will linger for 6D6 minutes, then lift and fly off into the distance. Despite the time on their watches (and minimal fuel consumption), it will be 2D6 hours later. The characters will be exactly where they were just before the cloud engulfed them, but the storm will be nowhere in sight.

The cloud is a P.P.E. leech and will have temporarily drained everybody of their P.P.E. (leaving only 2 P.P.E. points per person). The usual rate of recovery is applicable (this includes magic items).

- 48-56** **One Greater Entity** will create a body for itself out of seaweed, rags, magazines, debris, or the most readily available loose material, and attack the humans. This will occur on an airplane as well as a boat. The thing will be in a foul mood, with a taste for blood. It will fight until its artificial body is destroyed; 80 S.D.C. points (double if the characters are heavyweights with a lot of firepower). Horror Factor: 15.
- 57-65** **Sudden Storm:** A gale whips up out of nowhere. Aircraft must turn back and land until the storm is over or try to go around it (a large detour). Water vessels will make no headway against the storm despite the crew's best efforts. Radio and sensory instruments are unreliable (function only 40% of the time). The storm will last for 2D6 hours. Odd shapes in the waves and clouds may be noticed. When the storm subsides, the vessels caught in the tempest will have suffered only minimal damage; a miracle considering the ferocity of the storm.



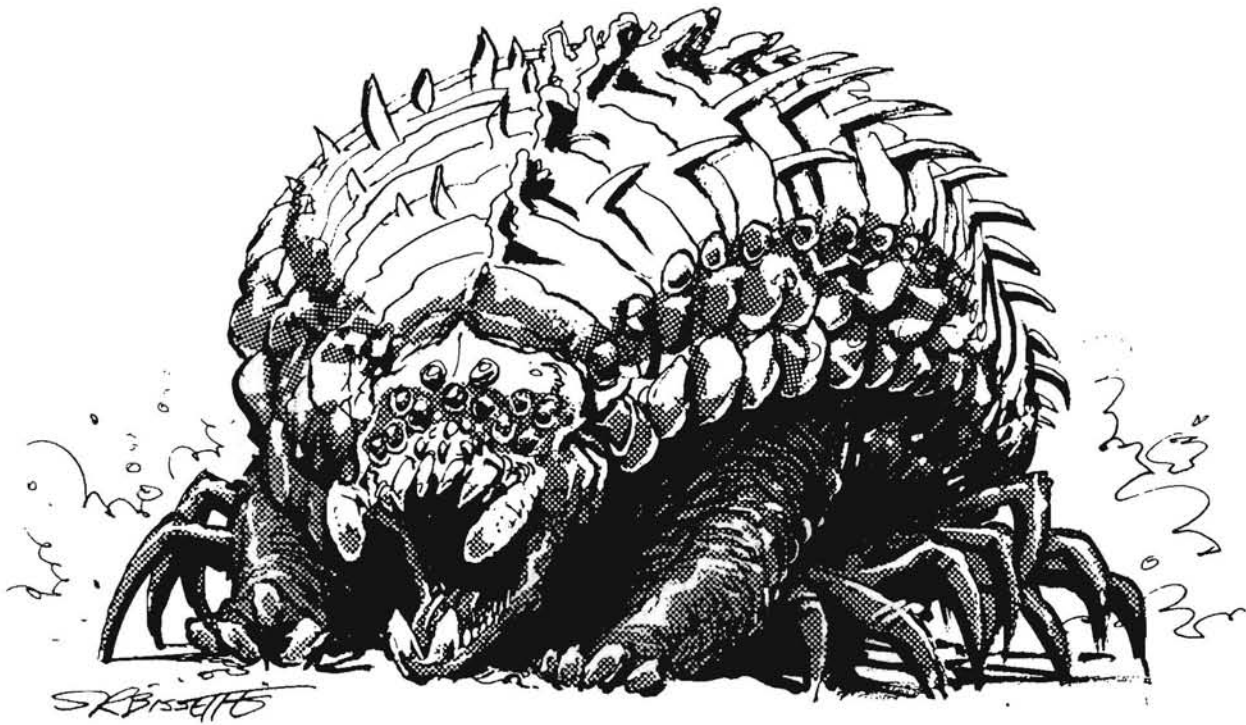

**66-74 Creature in the Hold:** Somehow, some kind of horrible creature got inside of the hold or cargo area of the vessel. This is the result of the multidimensional vortex teleporting a supernatural creature into our world. "It" is as surprised by this turn of events as the characters. Scared and hostile, the predator will lash out with murderous intent. **Game Master Note:** Select any of the non-magical, predatory creatures from the monster section. The creature will fight until it is killed or can escape.

**75-83 Surrounded by Odd Sky:** A sickly, unnaturally colored sky completely surrounds the vessel (violet, green, orange, brown, your choice). Equally odd colored cloud formations streak the skyline. Turbulence hints of a storm nearby, although it can not be seen. The radio is a wall of static, the compass needle spins counterclockwise like a tiny propeller. The remaining instrumentation seems a bit twitchy, but functioning (about 70% accurate). A character of evil or selfish alignment will hear a voice in his or her head. The voice will identify itself as a powerful creature (perhaps even a deity) and promise the person more power, respect, wealth, revenge or whatever else is required to tempt the character, than he/she has ever imagined. All the person has to do is allow "it" to *join* with him/her to share in "its" power. This is a powerful being of magic that can divide itself into multiple essences. If the person agrees, the creature will implant a part of itself into him/her, getting a foot in the dimensional door. This is not a full-fledged possession, so a psychic sensitive will not sense a supernatural presence or magic. (See *creatures of power* for details).

If all the characters refuse the offer, the voice will be forced to leave. A great turbulence will grip the vessel, rattling and shaking it for 2D4 minutes. Then it will stop and the sky will return to normal. The vessel will suffer no damage.

**Game Master Note:** Allow the player to play his normal character and this "new," evil persona that now shares his body. The demonic creature of power will either slowly corrupt the character and/or periodically seize complete control. This is an excellent opportunity to role play, like an actor who portrays twins, one good and one evil. At first the being will be very cautious and try not to alert the other characters to its presence. "It" is likely (70% probability) to try to trick the group into opening a dimensional doorway at a place of power so that it can bring its physical body into our world (this is its most powerful form). GMs can also have this happen to a non-player character who can be molded into a long or short running villain.

**84-92 Ghost Ship** (applicable to water and air): Out of a cloud bank, or mist, glides a battered, wooden, sailing ship several centuries old. The vessel's masts are hung with tattered sails and seaweed drapes the deck banisters and railings. No crew can be seen. A red or violet light seems to radiate from the vessel, making goose bumps crawl across all observers' flesh. Whether the characters are in a boat or airborne plane, the ghostly apparition will catch up to them and match their speed. It will ride alongside mimicking every maneuver: slow, fast, turn, stop, etc. (Yes it can keep up with a jet aircraft). Radar will *confirm* that something *is* definitely there. All instrumentation on the characters vessel will work perfectly. A psychic sensitive will be able to sense supernatural evil, magic and unnatural presence.

*After the ghost ship has followed alongside for a few minutes, roll for one of the following occurrences to take place on the character's vessel. Roll Percentile Dice:*

**1-16** A small fire springs to life out of nowhere! It is a potential danger, but can be easily extinguished if immediate action is taken (within 1D4 melees). If the



fire is not put out it will continue to grow, like a normal fire, and threaten the entire vessel.

**17-33** ALL lights go out! Replacing fuses or light bulbs will have no effect. Even flashlights will not operate; only torches. The lights will remain off until the ghost ship leaves.

**34-50** The engine(s) suddenly stop!! Aircraft will begin to descend, boats will be set adrift. The engines will remain dead for 2D4 melees, then suddenly spring to life again.

**51-66** A sudden, unexplained turbulence shakes the vessel, but there is no apparent wind, waves or storm. Lasts for 2D6 minutes.

**67-84** A thunderous pounding assails the vessel, as if a huge, powerful fist was pummeling the hull. It will persist for 1D6 minutes.

**85-00** Instruments go haywire, spinning crazily. Lasts for 1D6 minutes.

**NOTE:** the ghost ship will pace the character's vessel for 4D4 minutes before it veers away and disappears. However, if the ghost ship is boarded by any character, the following will take place:

**Boarding the ghost ship** is possible (at least for other boats). The ancient ship seems absolutely real! Battered, but sound. A minute after the ship has been boarded, roll again on the preceding occurrence table to see what is happening on their own vessel. After two or three minutes of further investigation, the characters on board the ghost ship will be besieged by 1D6 poltergeist. The entities' attack will be more unnerving than harmful and lasts a mere four melees (one minute). A few moments later, each character on the specter vessel must roll to save vs psychic attack as Empathic Transfer: Fear washes over them. Immediately, the following melee, a hatch will open by itself, unleashing 2D4 animated skeletons; the crew. The skeletons are garbed in rags and brandish rusty swords and clubs (all weapons do 1D6 damage). They will step upon deck howling and grunting menacingly, but will not attack until one minute has passed (that's four melees) or they are attacked first. If the characters flee to their own vessel, the skeletons will go back into the hold and the ship will sail away. If they linger on board the ghost ship the skeletons will attack. The fight will continue until the living intruders have jumped ship or are killed. The skeletons, possessed and controlled by entities, will fight until their bone bodies are destroyed. However, unless the bones are burnt up or smashed into powder, the entities will reform their skeletal bodies within six minutes for a renewed attack. Plus, another 3D6 skeletons are still in the hold to slay any intruders who enter the lower decks. The fighting will continue until all human intruders have been repelled. Then the ship will turn and leave. **Note:** The ship itself will not burn and the skeletons will not leave the ghost ship.

**93-00 Space Warp:** The characters' vessel is caught in turbulence, the radio is all static and the instruments are all relaying contradictory data. The sky begins to change colors, then turns into a swirling, white void. Pilot and passengers all lose their sense of direction, including up

and down. The weirdness lasts for 3D4 minutes, then gives way to a normal clear sky and instruments return to normal. But all is not normal. The vessel, whether it be a conventional airplane, jet, sailboat or ocean liner, will be miles away from the spot where the occurrence began. Add 30 miles (48km) for every minute the odd event lasted. **Example** The weirdness lasts 11 minutes (roll 3D4), so the vessel has traveled 330 miles ( $11 \times 30 = 330$ ).

Next, roll to determine the random direction the characters have traveled. Roll percentile dice.

1-20	The original course
21-40	North
41-60	South
61-80	East
81-00	West

## THE GAME MASTER'S OPTION

Each of the six triangles is a dimensional gateway that periodically swings open, allowing all types of supernatural or alien creatures into our world. The game master can use the *Triad Random Encounter Table* provided in this section, or use it as a guideline to create his/her own specific selection of weird happenings. The game master can substitute monsters selected from this book, create his own, or use creatures from other Palladium Books® role-playing games or other games produced by other companies. Remember, this is a multidimensional rift so almost anything is possible. **Warning:** 1) the most powerful, deity-like creatures of power, are seldom able to enter our dimension through a triad. Consequently, they are not likely to be an opponent. 2) G.M.s be careful! Do not get too wild. These regions may allow as many as a few dozen supernatural creatures into our world each time the dimensional rift swings open, but the areas are *not* crawling with monsters. After they get in, they scatter to other places of power around the world. As little as 15% will remain near the triangle.

The ambitious game master can allow the player characters to inadvertently enter into other dimensions, or back through time. The process would be like getting caught in a sudden storm at or over sea. The vessel would be buffeted by turbulence until it suddenly plunges into a void of swirling white clouds. While in the white, all instruments spin wildly, the radio will cease to function, and everybody loses their sense of direction including up and down. The whole effect lasts about three minutes (although it will seem two or three times longer), followed by five minutes of storm again. Then clear skies and working instrumentation. The question is, whose clear sky? The G.M. can plunge the characters into any kind of alien, supernatural or alternate world, from horror to fantasy, from science fiction to . . . well . . . anything. This can serve as a plausible way to link other Palladium Books RPG settings, characters or equipment with each other. The G.M. can also link or combine aspects of other role-playing games produced by other companies. After all, this is a multi-verse of an infinite number of alternate worlds. Again, I must caution the game masters who attempt, to link multiple dimensions to not get too wild. Giant, Robotech™ type robots, ogres and wolfen, super heroes and mutant ninja turtles, are not likely to mix real well in a contemporary Earth environment. **Beyond the Supernatural** should be more of a shadowy world; a somewhat subtle game, full of suspense, intrigue, mystery,



insidious evil, dark secrets and unheralded acts of bravery and adventure. Not a free-for-all.

*Here are a few things to consider when playing dimensional travel:*

1. Dimensional travel through a triad is extremely rare. The characters must happen to be at the right place (a tiny area amidst thousands of miles) at the right time. The odds of being randomly or intentionally swallowed by a dimensional vortex is remote (2% chance). Consequently, this should not happen more than once or twice in years of play. Dimension spanning magic is an alternative method, but requires vast amounts of P.P.E. and is fraught with danger, making it relatively uncommon.
2. Never plunge the characters into a hopeless, too deadly, environment.
3. Always give the characters a way to get back home. This can be done through happenstance, magic, places of power, or science, but provide some way out, otherwise it is an unfair dead-end.
4. Time distortion: One Earth day passes for every one week in the other dimension.

**Note:** The complexity of dimensional travel can be a tricky subject. If you, the game master, do not feel up to the task or simply do not wish to take the campaign in that direction, then don't! Dimensional travel can easily get out of hand and change the entire balance of the game.

**The mysterious island** can be a limited and controlled method of dimensional travel that may be more appropriate for most game masters. It works something like this: The character's boat or aircraft is caught in a storm. Distortion makes radio contact impossible. The instrument panel goes dead or acts wildly, while the compass needle whirls around like a tiny propeller. The storm's turbulence is tremendous and threatens to destroy the vessel. Sense of direction is uncertain and it seems only a matter of time before the vessel is destroyed. Suddenly, the storm breaks away to cloudy, white sky (the clouds may be swirling counterclockwise or moving at great speeds in the opposite direction of the characters' vessel). After a few minutes, the vessel moves out of the strange, white clouds and into an area of calm and drizzle. A small island (no larger than 50 miles/80km in any direction) can be seen a little ways in the distance. It seems to be safely nestled in the calm of the eye of the storm. The storm rages on, in even greater intensity, all around the isle. A boat or ship can easily dock offshore, while an aircraft can land in the grassland or flat scrub land without difficulty. (G.M.s, the grassy flat land should be large enough to allow any size aircraft, including a jet liner, to land and take off). Once settled on the island, the vessel will seem remarkably unscathed by the fierce winds and turbulence of the storm. The storm will continue to rage all around the island for days (the length of the characters' stay), although a bit of sunlight may peek through the ominous clouds above the island.

There are three approaches to adventures on the island:

1. The characters have bridged dimensions and are in *another* world, but adventures are limited to the island.
2. The entire island has been plucked from another dimension and will exist in *our* world for the duration of the dimensional storm.
3. The island is an anomaly of space and time caught in the

dimensional vortex. Thus, it can be inhabited by people, animals, or creatures from any time of our Earth's history (or future).

In the case of possibilities #1 and 2, the game master can design any type of environment and stock it with all types of supernatural beings, unearthly creatures, odd civilizations, magic that only works on the island, or whatever the individual G.M. feels is appropriate for his campaign and players. Again, game masters should feel free to draw on their imagination or other sources of inspiration including other role-playing games, novels, comic books and movies.

*To escape the island*, the characters must get back on their vessel (or a new vessel) and go back into the never-ending storm. After about 20 minutes of storm will be the white clouds, "pop" through the dimensional door and back home. Regardless of the amount of time spent on the mysterious island (days, weeks, months), only 3D4 hours will have expired on Earth.

## PROLONGED EXPOSURE TO PLACES OF POWER

Constant or extended exposure to ley line energy will have a negative affect on psychic characters. Although the potential psychic energy radiated by ley lines and other places of power boosts the psychic's psi-abilities, it also subjects the individual to constant P.P.E. stimulation. After a short while the psychic will begin to suffer from overstimulation. The constant flow of extra psychic energy will act as a sort of psychic adrenalin rush that never stops. Consequently, the psychic will begin to feel on edge, tense, jumpy, and irritable and may become melancholy, quick-tempered or hostile.

### THE NEGATIVE EFFECTS OF PLACES OF POWER

Prolonged exposure to the constant psi-energy at places of magic will begin to adversely affect psychic characters within ten hours. The energy from ley lines, ley line nexus points and transitional places of power, are the most dangerous because they each provide *constant* potential psychic energy (P.P.E.). Rips of magic are so very localized that their energy never goes beyond their tiny radius and are easy to avoid. Power triads are dimensional gateways that do not provide psychics with additional P.P.E. stimuli.

### THE SIDE EFFECTS

Prolonged exposure to potential psychic energy (P.P.E.) for 10 hours or more, within a 24 hour period, will begin the process of mental and emotional deterioration. **Note:** The character will *still* enjoy all the benefits that the ley line energy provides, such as additional I.S.P., enhanced psi-abilities, and so on, but will also suffer from the energy as a side effect of constant psychic stimulation. In some cases, the bonuses and penalties will negate each other, at least for a while. **The nega-psychic** is the only exception, and suffers no adverse side effects whatsoever!

#### Phase One: After 10 Hours.

All psychic character classes (P.C.C.), will feel a little on edge, anxious, jumpy. *Ordinary people* (non-psychic characters) suffer no ill effects regardless of the time spent on or near ley lines — days, months or years. The same is true of the *nega-psychic*.



### **Phase Two: After 20 Hours.**

All P.C.C.s feel anxious, tense, jumpy; sleep is difficult and not restful.

### **Phase Three: After 50 Hours.**

All P.C.C.s feel very tense, edgy, easily agitated and quick to anger. A constant, dull, throbbing headache and nausea adds to the discomfort.

### **Phase Four: After 70 Hours.**

All P.C.C.s are jumpy, grouchy, agitated, argumentative and moody. Sleep is increasingly difficult; only about four hours of restless sleep is possible per day. All feel very stressed. The headache persists, but the nausea is gone. **Penalties:** -1 on initiative rolls, -5% on all psychic skill abilities that have a success ratio or skill level, including clairvoyance, object read, recognizing enchantment and possession, parapsychology and similar skills.

### **Phase Five: After 90 Hours.**

All P.C.C.s suffer from high anxiety, tension, nervousness, the relentless headache, and sleeplessness. **Penalties:** -2 on initiative, -2 to save vs horror factor, -10% on all psychic skills (as described previously), -5% on all other skills. Characters who are accustomed to drinking alcohol have a 50% chance of getting drunk regularly; roll once for every six hours. See the effects of alcoholism and totally drunk in the insanity section. The withdrawal symptoms do not apply, because the character is not an alcoholic . . . yet. The individuals will tend to be argumentative, confrontational and hostile, given to shouting, breaking things, pushing people and even fist fights (will not fight to kill, only to zero S.D.C. at the worst).

### **Phase Six: After 160 Hours (equal to about 7 days).**

The P.C.C.s all suffer from the previous symptoms PLUS a 32% chance of developing a phobia and a 22% chance of developing an obsession. **Note:** These are not permanent insanities and will go away completely if the character is removed from the ley line energy for at least 26 hours.

### **Phase Seven: After 220 Hours or more.**

All the previous symptoms continue, but on an increased level. **Penalties:** -4 on initiative, -4 to save vs horror factor, -15 on all psychic related skills, -10% on all other skills. The chance of developing a phobia is 52% and the chance of developing an obsession is 32% (roll once for every 60 hour period beyond 160 hours).

### **THE CURE**

To negate all the negative side effects, from the headaches and drunkenness to phobias and obsessions, the psychic character (all P.C.C.s) must be removed from the source of the constant P.P.E. stimulation for at least 26 hours. At the end of the 26 hour period, the character(s) will be his old self, free from tension, phobias, obsessions, and all other penalties. The only lingering effects may be a hangover and/or exhaustion, both of which can be cured with another 24 hours of complete rest and plenty of sleep. Returning to a ley line will start the side effects anew, *beginning with Phase One.*

### **HOW OVEREXPOSURE IS DETERMINED**

A psychic character (this includes all the psychic character

classes/P.C.C.s, except the *nega-psychic*) can safely spend about eight or nine hours at a place of power, over a 24 hour period, without ill effects. If ten or more hours are spent at such places over 24 hours, the character will fall victim to the overstimulation of the potential psychic energy. The P.P.E. stimulation affects only the psychic character classes, not ordinary people, because they are all sensitive to P.P.E. and each uses that energy in one way or another. *The nega-psychic* is the only P.C.C. which is NOT adversely affected by the ley line energy.

The amount and effects of ley line P.P.E. stimulation is an accumulative thing, like drugs in the blood stream. Even though there may be short periods away from the stimulus the nervous system is still saturated. To be completely "clean" from ley line stimulation the character must spend less than 10 hours within the effective radius of the ley line and not return for at least 24 to 26 hours. Any greater lengths of time will begin the process of excessive exposure and mental debilitation.

The period of exposure should be gauged by 24 hour increments, beginning with the moment of exposure to ley line energy and continues to accumulate over each 24 hour period. **For Example:** Thomas Halloway is a psychic investigator hired to rid an allegedly haunted house of its bothersome spirits. Unknown to Tom, the house rests only a few miles from an active ley line and well within its five mile area of affect. Tom, a psychic sensitive, spends his first five hours at the house exploring each room. Around six p.m., Tom leaves to eat at a restaurant and to pick up some supplies at a town outside the affect of the ley line. He returns four hours later (ten p.m.), spends another hour settling in and goes to sleep. Although Tom spent four hours away from the house and ley line energy, he returned within 24 hours, so the time of exposure from the first five hours is *added* to the time spent settling in (one hour) and the time spent sleeping (eight hours). This means that when Tom awakens at seven a.m. he will have accumulated 14 hours of ley line stimulation. He spends another hour washing and eating breakfast (15 hours of exposure) before leaving for the town's library to do some historical research. Tom spends 12 hours away from the house, returning that evening around eight p.m. Although he was gone for quite a while, Tom is still under the influence of 15 hours of P.P.E. stimuli. At this point he probably hasn't noticed that he's been feeling a little tense all day. By the next morning (seven a.m.), Tom has spent another eleven hours under the influence of ley line stimuli, for a total of 26 hours. He wakes up after a *restless* night's sleep feeling a bit tired and tense. He thinks to himself that he must be edgy anticipating an encounter with the poltergeist or haunting entity that is supposed to be in the house. He resolves to open himself psychically to see what he can sense about the place. His exposure to the ley line energy continues. The really debilitating side effects will not occur until the character has been exposed to over 90 hours of psychic stimulation, so it is very possible that he will complete his investigation and rid the home of its supernatural house guest before he ever gets to that point. The more time he spends away from the house, the longer the accumulated hours of exposure will take to reach a serious level of impairment. Should Tom leave the house for a 26 hour period, he will return completely well and the effects of P.P.E. ley line exposure will begin again, at phase one. Of course, during the entire time under the influence of the ley line Tom will be able to (unknowingly) draw on its energy to supplement his own psi-abilities (*See Places of Power*).



An example of the good and bad effects of ley lines.

Obviously, the prolonged negative influence of ley line stimuli on psychic individuals prevents them from staying at the site of a ley line or nexus. These natural places of psychic power must be used with discretion.



*SR Bissette 11/87*

## THE BRITISH ISLES

Thousands of prehistoric, megalithic structures are scattered throughout the British Isles and Northern France. Mute sentinels standing guard over, what men of magic call, places of power. Most of the ancient structures rest on ley lines, a few on rips of magic (isolated pockets of P.P.E.), a few others on transitional places of power long since devoid of energy, but a handful of the most impressive sites denote ley line nexus points. It is at the nexus (junction) where several ley lines cross that the potential psychic energy is at its greatest.

The following prehistoric structures are believed to be places of power.

### ENGLAND

#### STONEHENGE (Ley Line Nexus)

Stonehenge is the most famous of all the stone circles, but its larger sister circle lies in a straight line about 25 miles (40km) to the north at Avebury. Without getting into the historical nitty-gritty, Stonehenge is believed to have been constructed over an

800 year period, beginning about 2800 B.C. and completed about 2075 B.C. (some place its construction a thousand years earlier). There is also clear evidence that parts of Stonehenge were destroyed and rebuilt at least three or four times during that period.

The builders are a mystery. Presumably, the prehistoric Picts or Celts were the original architects, although most historians believe them far too primitive. Whoever the builders were, they knew the secrets of ley lines, magic and astronomy, because Stonehenge rests squarely on the intersection of 37 ley lines and is clearly an ancient astronomical observatory. The fifty-six Aubrey holes served to predict Lunar Eclipses. Other stone alignments indicate winter and summer solstices, as well as the vernal and autumnal equinox. If the builders had this knowledge they could predict solar eclipses as well; each a time of increased energy activity for ley line nexuses.

If the Celts built Stonehenge, the Druids inherited her mystic secrets, continuing a legacy of magic (although almost certainly



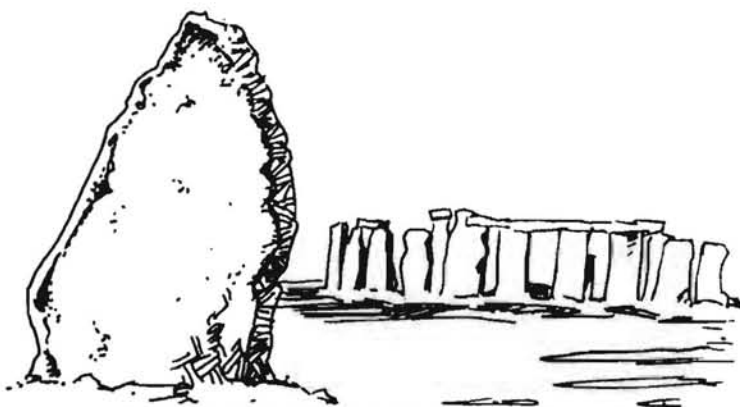

A VIEW OF STONEHENGE FROM THE HEEL STONE

magic with a different orientation). Today the stone circle is a tourist attraction that draws thousands to look upon its 20 ton pillars of stone. Yet, though forgotten by most, the energy still flows. Practitioners of magic, cultists and the curious, still sneak to the site to draw on its power.

**Some observation by Victor Lazlo:**

*"Many have wondered about the reasons behind the several times Stonehenge was partially razed. Considering the structure's importance in magic, I wonder if it could have been (and still is) much more than an astronomical observatory to take advantage of the ebb and flow of geo-psychic energy. Surely, if these ancient geomancers fully understood the secrets of magic and ley lines, they knew that maleficent supernatural beings could gain entry into our world during certain celestial occurrences, such as eclipses. Likewise, an insane wizard or cult could create a dimensional opening, calling forth horrific creatures. Is it possible then that these ancient men of magic built not an observatory, but a fortress to combat invaders from another world? The astronomical aspect of the structure would be crucial in predicting the exact time an invasion (or even a chance entry by supernatural forces) would occur, because it would correspond with the increase of geo-psychic energy. Armed with this knowledge, an army of ancient wizards and warriors could stand ready to repel the demonic invaders from another world. Perhaps it was during such battles that the great circle was damaged. Of course, this is all completely my own wild imaginings. There is no evidence to support such a notion other than the abundance of legends and lore regarding ghosts, faeries and all manner of supernatural beasties. Still, it is a thought that I fondly entertain."*

**STONEHENGE TODAY**

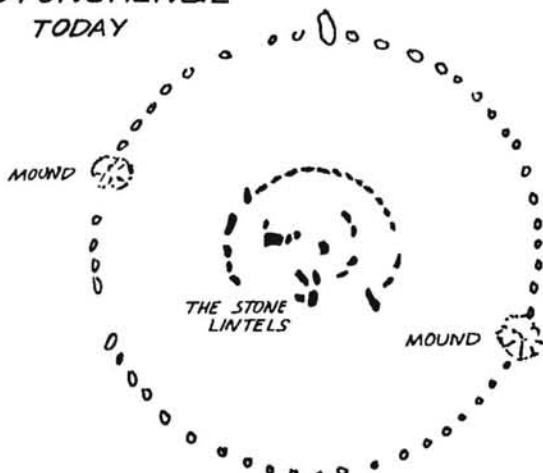

Victor Lazlo on a related topic:

*"The case of the so-called 'Devil's Footprints' of February 9, 1855 have always amused and befuddled authorities. To this day there is no logical explanation. By all accounts, several towns around Exe estuary, including Dawlish, Mamhead, Lympstone, Exmouth, Withycombe Raleigh, Woodbury, Teignmouth, Starcross, Exe, Topsham, Clyst St. Mary, Clyst St. George, East Budleigh and Bicton, awoke to find the countryside covered with strange footprints. Donkey hoof-like, 4 x 2 1/4 inch prints in the new snow, that walked not like an animal, but with strides like a man. Not only did the prints cover a 50 mile (80km) area, but they hopped up onto window sills, walked up to walls and began again on the other side (indicating that the 'thing' walked through walls or leaped over them — 10 and 15 feet high/3 to 4.6m in a single bound), covered rooftops, high fences and hayricks. Furthermore, the strange tracks appeared on both sides of a two mile sea. No man nor animal could have traversed that extent of country in one night. What manner of supernatural visitation happened that night, over a century ago, is unknown, but it did happen. I read of this incident and have to wonder if Stonehenge, Amesbury and/or Avebury, about 100 miles to the northeast, played any part in this phenomenon?"*

**AMESBURY (Ley Line Nexus)**

About ten miles northeast of Stonehenge is the Amesbury ring of stone. Like Stonehenge, it is a ley line nexus with lunar and solar observation capabilities. Its history and mystique are nearly identical to Stonehenge. The period of construction is also about the same time, 2800 B.C.

**AVEBURY (Ley Line Nexus)**

About twenty miles northwest of Amesbury and north of Stonehenge is the Avebury Ring, the largest circle of standing stone in the British Isles. It covers 28 1/2 acres; its original ditch was higher than a two-story house and the thing encompasses a whole village in Wiltshire. The main circle is composed of stones weighing as much as 60 tons, taken from quarries miles away. This means hundreds of trees had to have been cut down to clear a path to transport the massive stone slabs through the dense forest. Like Stonehenge, it must have required generations of people to erect. Most scholars believe the construction of the Avebury circle began around 3200 B.C. and that it was not completed until about 2600 B.C. although some claims place it a 1000 years earlier. Most agree that its inception predates Stonehenge by at least 400 years. Its astronomical orientation is believed to include both solar and lunar movement.

**Some observations by Victor Lazlo:**

*"The stone circles of Stonehenge, Amesbury and Avebury are the most impressive of their kind in England. And while each is located at a ley line junction of geo-psychic energy, I have made a more startling observation: three ley lines connect each of the three circles creating a mini-power triad! I must ask myself, can this be possible? No other 'landlocked' power triad is known to exist. Furthermore, the location breaks the pattern of the six ocean triads. There are many irrefutable things which prove that it can not be part of the 'natural' system of dimensional triangles. But could it be a man-made triad?"*



*"If the energy of the three nexus circles on the Orkney Island could be linked to focus that energy into one powerful moment at Maes Howe, could not a similar process be used to link the three circles in England? And if the most powerful geo-psychic energy, which occurs during solar eclipses, could be harnessed, the outcome could be incredible — at least three times greater than what the Orkney lunar chain could produce! (Editor's Note: That's a minimum of 3000+ P.P.E.) Would the ancient wizards even have dared such a feat if it were possible? That much geo-psychic energy would produce a dimensional rift just as a side effect.*

*"The possibility of creating a man-made dimensional gateway is not impossible, presuming that the linking spell/magic knowledge did exist at one time. The pure happenstance of three ley line junctions being connected to form a triangular shape is a pure quirk of fate. That the prehistoric masters of magic were able to recognize and take advantage of that chance occurrence is only logical. Which of the circles served as the focal point where the dimensional gateway would be opened was likely to have been Stonehenge. This would certainly explain why it was partially destroyed so many times and rebuilt. It would also explain the numerous sightings of strange creatures, demons and UFOs throughout the centuries. But for every answer there are more questions. Did the ancients build a village in the humongous Avebury circle? If they did, why? Could it have served as circle of protection too? Or was it settlers a thousand years later who unwittingly built their little town inside Avebury? Is it possible that the dimensional gateway still swings open from time to time, perhaps during a solar eclipse? I do not know if any of this is possible, yet something inside me tells me that I am on the right track."*

## **SILBURY HILL (Ley Line)**

Near the vast Avebury circle is the massive artificial hill built at least circa 4200 B.C. and possibly earlier. Its base covers 5 acres, and was built with great care to ensure that the 10 story mound did not collapse. Archaeologists and treasure hunters have dug into the gargantuan mound, but have unearthed absolutely *no* artifacts. Why the hill was ever erected, and by whom, remains a mystery.

### **Some observations by Victor Lazlo:**

*"The enigma of Silbury Hill will probably never be solved. It obviously held some great importance to the builder because it is an architectural marvel that required over 36 million basketfuls of chalk and generations of labor for hundreds of people. Silbury Hill is not a ley line nexus, although it does rest on a ley line that intersects with Avebury. My guess is that the site may have been an important 'Transitional Place of Power' that had lost its geo-psychic energy a few thousand years ago. Another possibility is that it was an early attempt at identifying ley line nexus points and that the fledgling prehistoric mages were trying to mark the ley line junction at Avesbury and missed the mark. However, I find the latter possibility most unlikely."*

## **LONG MEG (Ley Line)**

A series of large, flat, circular barrows march in a line, denoting the presence of a ley line. To the west is the Castlerigg Circle of stone.

## **CASTLERIGG (Ley Line Nexus)**

Near Keswick, in the English Lake District, is another circle of stone known as Castlerigg. It is a much smaller circle than Stonehenge, believed to have been built around 2100 B.C. The stones seem to be aligned to the cycle of both lunar and solar movements.

## **IRELAND**

### **NEWGRANGE (Ley Line & Transitional Place of Power)**

Perhaps the oldest existing building in the world is Newgrange in Ireland, about 35 miles from Dublin. Its estimated time of construction is placed at about 3400 B.C., but some believe it could be a 1000 years older. Newgrange is an earth mound 36ft high (11m). An entrance hall at the foot of the mound is lined with 450 massive slabs of stone carved with swirling patterns. The entrance hall stretches 62ft (18.8m) deep into the mound, opening into a spacious, circular chamber about 20ft high (3.1m), from which opens three smaller chambers. The roof is a beehive shaped corbelate type with overlapping slabs. The most unusual aspect of Newgrange is the "roof box" opening at the entrance that allows the first rays of sunlight on the morn of winter solstice to illuminate the entire chamber network for several minutes. So bright is the light that a book can be read without difficulty. As is usual with megaliths, the builders of Newgrange are unknown. Likewise, its purpose and reason for astronomical alignment, are also a mystery.

### **Some observations from Victor Lazlo:**

*"Newgrange is an enigma. Its construction predates the first pyramid by at least 500 years and exhibits architectural skills, mathematics, and astronomy knowledge generally not ascribed to the ancient Europeans. Some scholars have gone so far as to say that Ireland will be found to be the true birthplace of civilization. Perhaps. From a strictly arcanist's viewpoint, there is no doubt that the ancients of the British Isles possessed much greater scientific knowledge than most modern historians give them credit for. But is Newgrange a place of magic? If it is, it may have been the very first stone edifice constructed for mystic purposes. However, there are no legends or tales or artifacts to suggest such notions. The case for magic rests on four points of circumstantial evidence. 1) Newgrange is located on a ley line, but is not near a ley line nexus. 2) Its construction resembles the structure at Maes Howe. 3) It is presumably constructed by the same builders as the other megaliths and should then share their relationship as places of magic. 4) It does have a definite link to the winter solstice at what would be a high geo-psychic energy surge at a ley line nexus (which Newgrange is not).*

*"My guess is that the Newgrange may be the site of a 'transitional place of magic.' Presumably the place flows with unusually high geo-psychic energy every 'X' number of years, beginning at the midwinter solstice. Of course,*



this is pure conjecture. There are not even rumors or old wives' tales to substantiate this theory. However, there is one obscure incident which happened around World War I. A man who claimed to be a mage from the Middle East was found wandering the countryside a few miles from Newgrange the day after winter solstice. The poor soul was utterly insane, but did ramble on about 'the secret of Newgrange' being his and his alone. This story was related to me by an old Irish chap who claimed to have been assisting the local physician who examined the man. The old fellow assured me that he remembered the incident clearly because Arabs were quite uncommon in Ireland and because of the incident which followed. As he could best recall, the Arabian mage spoke of a 'cycle of mystic energy' that filled the ancient mound every 'four generations.' The exact meaning of the madman's words were difficult to understand, said the old Irishman, because he would constantly slip from English to Latin to a totally alien tongue, presumably Arabic. The mage rambled on, alluding to the 'power of the ancients,' magic knowledge and demons. After the Arabs examination he was taken away by the constable.

The Irishman recalls passing near Newgrange on the way to his home. It was there that he was stopped by a tall man dressed in a full length, black cape with a hood. The man stood nearly seven feet tall and was of great bulk. His face was obscured by the hood of the cape and the darkness of the night. But the Irishman remembers a large mouth that smiled with pointed teeth. The stranger spoke in English, with a strange accent and a deep, rasping voice, asking about the Arab. Only a handful of people knew about the mad Arab. The questions and the stranger's visage scared the man. He denied knowing anything about the matter and insisted that he must get home for a later supper. The towering stranger frowned for a moment, grunted as if deep in thought, and smiled, saying, 'The constable, of course. You have been most helpful.' With that, the Irishman reined his horses, which had been nervous and jittery since the stranger's appearance, and rode his cart home at top speed. The next day, he learned that the Arab had died in the night, and that a tall, dark man with diplomatic papers claimed the body before daybreak.

"Whatever evidence there may have been in the way of a journal or log has disappeared over the course of two world wars and passing decades. The constable, a man then in his late 50s, died 60 years ago. And the storyteller himself has been dead now for over 20 years. No one else seems to recall any word of the incident. Is this just another folk tale? If it is true, then Newgrange is still an active place of magic. The incident happened around 1909-1916; the Irishman could not remember the exact year. Assuming a generation is 20 years, then Newgrange will erupt with geo-psychic energy sometime between 1989 and 1996 in an 80 year cycle, beginning at the first light of winter solstice. I will have to investigate this possibility myself when the time comes. From the description, the energy sounds to be equal to a total solar eclipse." (Editor's Note: It is actually greater than a total solar eclipse, unleashing 3400 P.P.E. during the first 5 minutes of daybreak and a residual 600 P.P.E. that will last till the next

daybreak/24 hours or until it is used up, whichever comes first).

## SCOTLAND

### CALLANISH (Ley Line Nexus)

On the Isle of Lewis, the northernmost of the Hebrides, is the megalithic site of Callanish. High on a ridge overlooking the surrounding hills rests the remnants of an ancient place of magic. Most experts agree that the structure was built about the same time as Stonehenge or perhaps 700 or 800 years afterward — about 2000 B.C. (although some place both the creation of Callanish and Stonehenge at around 4000 B.C.). The most striking difference between Callanish and the other circles is that its overall appearance is that of a skewed Celtic cross extending over 400ft (122m) north and south and about 140ft (42.7m) east and west. (See diagram.)

Like Stonehenge and the other circles, Callanish is a complex and accurate astronomical tool which can be used to predict the vernal and autumnal equinox, summer and winter solstice, eclipses and the movement of the sun. Also, like Stonehenge, it is a place of power, a *ley line nexus*.

### MAES HOWE (Ley Line Nexus)

Three significant megalithic sites can be found on the northern British Isle of Orkney; Maes Howe, the Rings of Brodgar and the Stones of Stenness. Each is believed to have been built at the same time (2900 B.C.) and run in a straight line from each other, with the circle hedge of Stenness three quarters of a mile to the west and the Rings of Brodgar beyond that. Maes Howe is a mound observatory surrounded by a circle of packed earth and sits upon a man-made hill. Inside the mound is a low passageway (4½ feet tall/1.37m) which runs about 52ft (15.8m) into a chamber 16ft (4.9m) high. The chamber walls are made of dry stones so tightly wedged together that it is impossible to push a knife blade through them. Maes Howe is known for its winter solstice rituals (the *sun sets* over a barnstone 22ft from the entrance). The last rays of sunlight beam through a 'letter box' above the tomb's blocking slab to illuminate the inner chamber, but only on the eve of winter solstice.

#### Some observations by Victor Lazlo:

"I suspect that the three megalithic constructs on the Orkney Islands are interrelated; each a part of a massive mystic complex. The Stones of Stenness and Brodgar are a typical astronomical observatories and places of power, but Maes Howe is clearly different. Dismissed by most as a burial mound, I must disagree. Maes Howe is a crucial component in a trilogy of mystic circles and geo-psychic hot spots. My theory is this: that somehow, perhaps with a magic spell or ceremony lost to antiquity, wizards at the two stone circles could funnel their energy to Maes Howe like a ley line electric circuit. This would occur at the precise moment of the beginning of night at winter solstice (since morning would provide more geo-psychic energy, we must presume there was some other reason, perhaps ceremonial, that required the nighttime energy surge). The low entrance tunnel and large, 16ft high (4.9m), inner chamber, suggests that a large room was required for the magic. I am convinced Maes Howe was used to summon supernatural beings. To what purpose, I do not know.



Certainly this would explain the large chamber and conspicuously small and lengthy tunnel. It would also explain the timing of winter solstice. A cult with the combined potential psychic energy of several dozen members added to the momentary surge of geo-psychic energy from three places of power (Editor's Note: That's 300 P.P.E. plus the P.P.E. from the cultists and wizards.) could generate enough energy to open a dimensional rift and call upon supernatural beings.

"This process, if it is possible, is ingenious. **First**, the supernatural creature would be contained in an underground chamber, making escape difficult. The fifty foot tunnel may have been sealed shut and/or lined with other mystics to combat the creature should it try to crawl out. **Second**, the massive energy of the winter solstice would have been completely expended by the act of summoning the being, preventing 'it' from using that energy against them. **Third**, the disoriented creature would be at the mercy of a well prepared group of wizards. Its only recourse would be to submit or be destroyed.

"To substantiate this theory, I quote an excerpt from the writings of Ian Zavius, a fifteenth century charlatan, but one who had incorporated the writings of an authentic ancient text. The place of three would act as one on the eve of the winter solstice. A demon would they summon, locked in the bowels of the Earth and compelled to do their bidding lest its spirit be dispatched to Hades (a reference to killing the demon if it failed to obey). And so enslaved, the demon they kept, till dispatched (killed) or returned to hell (its own dimension) on the morn of summer (referring to the dawn of summer solstice.)' Zavius attributed the quote to the magic of sorcerers from fabled Atlantis, but I believe the source is much closer to home — Maes Howe, Brodgar and Stenness."

**G.M. Note:** Lazlo's theory is correct, but the spell knowledge to link the three places of power, each a nexus, is unknown. Also, a combined total of 1000 P.P.E. is required. (334 P.P.E. at each of the three places).

## MAES HOWE

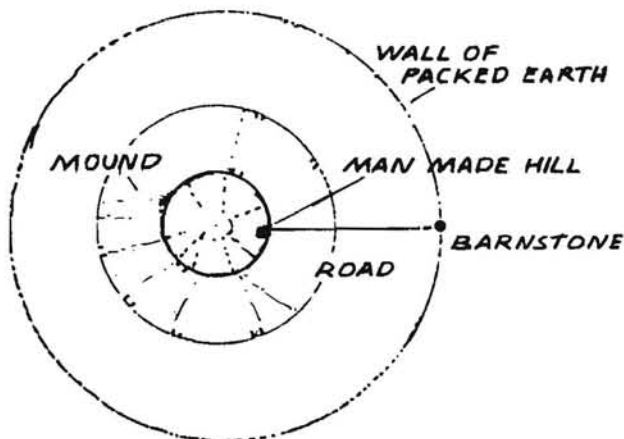

## THE STONES OF STENNESS (Ley Line Nexus)

Less than a mile west of Maes Howe are the four, battered standing stones of what was once a stone circle like Stonehenge. Originally, the circle contained twelve, 60 ton, sandstone monoliths (16ft, 4 inches tall/5 meters), but eight were destroyed over the centuries. Any clear astronomical significance has been destroyed, but it was, presumably, like Stonehenge and the other circles of Britain. It is a place of power; a *ley line nexus* that rests in the middle of a strong, four mile long ley line that directly connects the Stone of Stenness with two other nexuses: Maes Howe to the east and the Ring of Brodgar to the west.

## THE RINGS OF BRODGAR (Ley Line Nexus)

One of the largest stone circles of the British Isles is the Rings of Brodgar. Of the 60 original stones in the circle, only 36 remain and some of those are mere stumps. The stumps show that the 16ft (4.9m) standing stones were broken at or near the base, suggesting to archaeologists that they may have been snapped as a result of some natural catastrophe. Like Maes Howe and Stenness, its estimated date of construction is 2900 B.C. The diameter of the circle measures about 340ft (103.6m), with each stone set six degrees apart, beginning at geographical north. A 30ft wide (9m), 10ft (3m) deep ditch is cut into the solid bedrock around the circle of standing stone.

One of Brodgar's most significant features is that it is astronomically aligned to observe only lunar cycles/movement. No solar orientations at all.

### Some observations by Victor Lazlo:

"The exclusively lunar orientation of the Rings of Brodgar only reinforces my belief that Brodgar, Stenness and Maes Howe were each connected and most likely designed specifically to summon and control supernatural beings at Maes Howe at winter solstice. The site was also probably used for other feats of magic, particularly during lunar eclipses."

## CASTLE FRASER (Ley Line)

A small circle of ancient standing stones is found in a field at Castle Fraser near Aberdeen in Northeast Scotland. Its estimated date of construction is 2000 B.C. and like its larger cousins on the Orkney Island, appears to be aligned only to lunar cycles. However, the lunar calendar at Castle Fraser served a far different purpose than those on Orkney Isle. The Castle Fraser stones rest on a ley line that runs about 470 miles (155km) from Stonehenge in the south, connects in Avesbury and Long Meg, and extends just beyond Castle Fraser. Although the three Castle Fraser stones rest on a ley line, it is not a nexus point. Instead, it was a *transitional place of power*. Every 19 years, the moon is so low on the horizon that it appears to roll along the top of the recumbent stone, indicating the flare of potential psychic energy that occurred every generation (19 years). It's ironic that nearly 3000 years later the recumbent stone and its two flanking stones are still perfectly level and still show the arrival of the 19 year cycle. However, the periodic flow of powerful psychic energy no longer takes place as at Castle Fraser. Whatever strange anomaly caused this to be a place of magic has not happened in over 1000 years. Of course, the place is still alive with the usual (low) *ley line* energy.



## KINTRAW (Ley Line Nexus)

A single stone stands in a lonely field in the Scottish Highlands of Kintraw. In recent years it has been shown to align perfectly with a man-made cleft in a neighboring hill, which indicates the end of daylight on winter solstice. Kintraw is a little known *ley line nexus*.

## CLAVA CAIRNS (Ley Line Nexus)

A circle of stones surround a burial mound at Clava Cairns near Inverness. Like its cousins on the Orkney Island, this ley line nexus appears to be aligned only to lunar cycles. Of course, this would provide ancient practitioners of magic with crucial knowledge of high ley line energy fluxes during the midnight hour, the autumnal equinox, lunar eclipses and other planetary alignments visible only at night. Circa 2900 B.C.

### Some observations by Victor Lazlo:

*"Is it coincidence that we have another circle and underground chamber like Maes Howe only 80 miles northwest of Orkney Isle? Could this have been a second triple nexus alignment, with its two sister circles destroyed eons ago? Or is it a single circle meant to harness the geo-psychic energy unleashed at ley line junctions during lunar activity? The underground chamber suggests that it, like Maes Howe, could have been used to summon supernatural beings. Perhaps smaller, less powerful supernatural creatures were summoned here, while the more powerful monstrosities were called upon at Maes Howe. As is so often the case, there is no concrete evidence to suggest a connection, only my own intuition and imagination."*

## MACHRIE MOOR (Ley Line Nexus)

On the Isle of Arran in Scotland is yet another circle of stone, located in the foreboding Machrie Moor. Unlike its Scottish brethren, the circle at this ley line nexus is aligned for both lunar and solar observation. Thus, its ancient builders could identify the full range of ley line nexus activity.

**The Isle of Arran** is the site of several other megalithic standing stones and mounds, most of which are clustered within a few miles of Machrie Moor Circle. Most rest on or near ley lines and a couple are very localized "rips of magic," but the circle on the moor is the only ley line nexus on the island. Circa 3000 B.C.

### Some observations by Victor Lazlo:

*"Apparently, at one time, the Isle of Arran was a hotbed of supernatural and magical activity. The isle is covered by well over a dozen megalithic sites and crisscrossed with ley lines. Most of the ley lines intersect at the Machrie Moor circle of stones, which itself is directly connected, by ley line, to the Kintraw site about 50 miles (80km) to the north."*

## THE THOUSANDS OF OTHER MEGALITHIC STRUCTURES

The multitude of other standing stones, dolmens, cromlechs, circles and mounds, are *not known* to be ley line nexus points, but are mostly markers along the path of active *ley lines*. Others were once "transitional places of magic," which *no longer* hold any special power or significance except in the legends of the past. A few may mark "rips of magic" and a few may be unknown

ley line junctions (nexus) or stand near a new, active, transitional place of magic. But the majority (97%) of the remaining individual sites have little psychic or mystic importance.

Without a doubt, the ley lines and their many nexus places are the cause of countless supernatural incidents throughout the ages. The strange other-dimensional beings which have entered our world at ley line nexuses, or attracted by their energy, are the stuff of myths and legends about the British Isles. The faeries and their ilk, leprechauns, goblins, kelpies, and all the other monsters, giants, dragons, ghosts, spirits and demons of the British Isles, may well represent man's encounters with supernatural beings from other realms of existence. Creatures which may still inhabit the misty isles, for no other place on Earth is known to have so many ley lines and places of magic in such a small area.

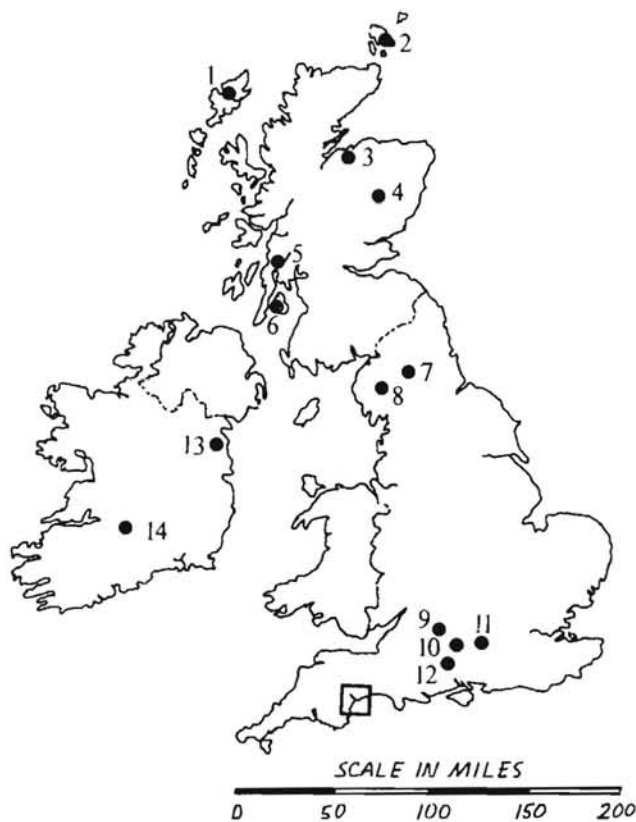

## The British Isles

1. Callanish
  2. Maes Howe  
Rings of Brodgar  
Stones of Stennes
  3. Clava Cairns
  4. Castle Fraser
  5. Kintraw
  6. Machrie Moor
  7. Long Meg
  8. Castlerigg
  9. Avesbury
  10. Amesbury
  11. Silbury Hill
  12. Stonehenge
  13. New Grange
  14. Keel Cross
- Square is the site of the Devil's Footprints.



# NORTH AMERICA AND SOUTH AMERICA

## MYSTERY HILL

One of North America's most impressive megalithic sites is Mystery Hill in New Hampshire, just outside of New Salem. The place is an anomaly in American history and therefore the subject of much debate and controversy. The site is composed of a maze of mortarless walls and standing stones four to five feet (1.2 to 1.5m) tall. The placement of the walls hints that this may be the remnant of a much larger and complex structure. It is known that farmers in the region used many of the stones for the foundation of their homes, which means at least 40% of the structure has been removed over the last century or so. There are also dolmen-like structures (a megalithic chamber made with three or more vertical stones supporting a capstone), like the giant, four and a half ton slab known as the "Sacrificial Table."

The controversy arises in that the indians *never* built anything like this. The style and use of stones cry out that there is an incredible link to it and its cousins in England. Carbon dating has been inconclusive, but megalith enthusiasts claim 2000 B.C., and carbon dating of some of the fossil root samples tends to support that assertion. The question then arises as to who could have built it. Could it be that prehistoric men braved the Atlantic Ocean to set foot on the new world two thousand years before Columbus?

Some observations of Victor Lazlo:

*"I will not even attempt to guess at who the ancient architects were nor how or when they got to North America. What I do know is this. The structure predates the arrival of the European to the Americas. Meaning, at best, it is several hundred years old if not thousands. It is definitely not of indian manufacture and bears a remarkable resemblance to the megaliths of England. I have it on good authority that the 'Sacrificial Table' rests exactly on a ley line nexus point. The place also seems to have a definite astronomical significance, measuring both solar and lunar movement. Is it coincidence that the Salem witch incidents occurred in this area? I think not."*

## INDIAN MOUNDS

The North American Indians were prodigious mound builders. Not only did they build hills, but molded them into the likenesses of animals, called effigy mounds. Effigy mounds are perfectly proportioned images of animals measuring a few hundred feet to a thousand. Like the mounds of Europe, the true purpose of the mounds is lost to antiquity. The lack of artifacts around the mounds indicates that they were built, then abandoned. Hundreds of such mounds were scattered across the United States and Canada, but most have been destroyed. Along the course of the Mississippi, it is said that dozens of such mounds were found. In fact, East St. Louis is built on the site of a strange pyramid that had amazed early explorers.

The most famous, and one of the few preserved Indian effigy mounds, is the Great Serpent Mound of Adams County, Ohio. The coiled monster stretches for a thousand feet (305m) and depicts a snake swallowing an egg. Although there have been intermittent reports of swirling leaves when there was no wind, and sudden feelings of dread or terror, the mound is *not* known to be a place of paranormal activity.

Some observations by Victor Lazlo:

*"I find myself obsessed with the Ohio Serpent Mound. Something about it gnaws at me, drawing me back to it time and time again. It has been guessed that the mound is a thousand years old, maybe older; yet, as always, no one knows why. One indian tale speaks about how the worshippers of reptiles were reduced by the fortunes of war. Defeated, they buried their god and built the effigy mound over him. Another legend speaks of magic and celestial powers. Most scholars agree that the act of the serpent swallowing an egg is an allusion to the moon. Universally, the coiled serpent represents magic, as it probably does here as well. Yet, I can find no mystic or historical significance. The mound is not on a ley line nexus nor even near a ley line. It is just a mound in the middle of a forest. But it can't be. There is something important here. Some link to magic I can not see, but I feel it. Perhaps it is the location of a transitional place of magic. If this mystery can be solved, I will solve it."*

## DESERT CARVINGS

Out west, the Mojave Desert is inscribed with over 270 geoglyphic carvings of animals, humans and symbols. Most of the carvings have been only recently (since the 1970's) discovered. The oldest figure is dated at 3000 B.C. and the most recent is about 300 years old. More primitive configurations, made of boulders to create abstract patterns may be 10,000 years old.

According to a Mojave Indian legend, one of the drawings, a giant human and a long tailed animal, is a depiction of an evil giant being driven out of their land by the creator god. Others have mystic or spiritual significance.

Another oddity are the "medicine wheels," as the indians called them. Giant circles marked in small stones, measuring 60 to 80ft in diameter. Historians guess that the 50 or so wheels found in the Big Horn Mountains of Wyoming and scattered across the plains of Arizona could be as much as 1000 years old. Many of the wheels have rocky piles in the center and around the outer rim that mark the sunrise and sunset on the day of the summer solstice.

In California's Death Valley, stones are known to move along in a zigzag, rolling pattern, etching their trail behind them in the parched earth. Of course, nobody ever sees the stones move, but they do.

## THE NAZCA DESERT CARVINGS

The most famous of all desert carvings are the gargantuan, runway-like lines and figures that measure hundreds of feet. Von Daniken popularized the carvings when he suggested that they might be landing markers of ancient astronauts in his book, *Chariots of the Gods*.

The spectacular markings are a complete mystery. Nothing is known about the people who carved them (no one even knows to whom to attribute the arduous achievements), when or why. It is certain that they are at least 700 to 1200 years old. No mystic properties have yet been attributed to them.

**Note:** *South America* and parts of Mexico seem to have a wealth of hidden history. The Aztec, Mayan, and Inca cultures were all considerably advanced and had accomplished the construction of spectacular cities, pyramids, and other incredible



ible edifices. The lore is rich with demons, gods, monsters and magic. Who can say what mysteries lay waiting to be uncovered.

### THE PYRAMIDS (Ley Line Nexus)

No man-made structure has ever evoked man's sense of wonder more than the pyramids of Egypt. Although generally believed to be massive monuments to specific Egyptian kings, nobody knows exactly how they were built, or for what purpose. Their recently discovered astronomical significance would seem to indicate that they are more than giant tombs.

Pyramids have been attributed with all types of special properties, including energy receptacles. The oldest and largest pyramid is the Great Pyramid of Giza, measuring 450 feet high (137 meters) and is believed to have been built about 2600 B.C.

#### Some observations by Victor Lazlo:

*"Again we see the concept of the mound, only this time man did not fashion the hill out of dirt, but built himself a mountain made of stone. A mountain aligned with the movement of the stars. Again we see the straight line emerge, with the pyramids of Khufu (Giza), Khephren and Menkaure marching in a diagonal line, each smaller than the preceding. The three small pyramids of the Queen stand in a straight line parallel to the Great Pyramid. A straight line points to the Great Sphinx and a straight causeway connects the Valley Temple to the mortuary temple at the foot of the Menkaure pyramid. Again we see the number three, just like the three circles on Orkney. And, like the man-made mound at Maes Howe, we again find*

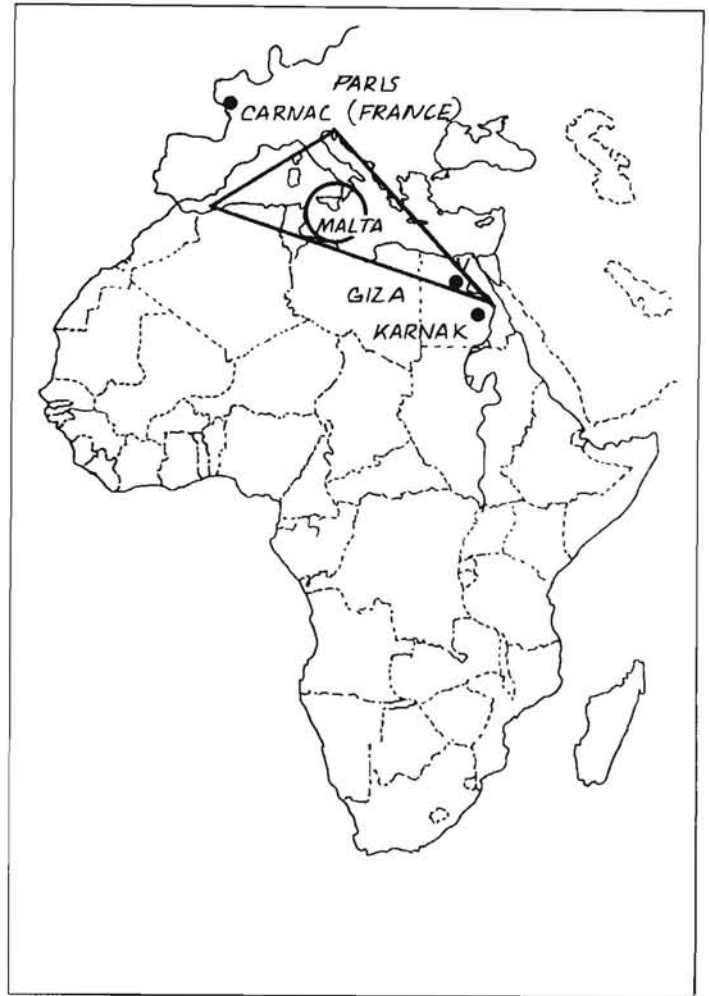

## The Giza Necropolis

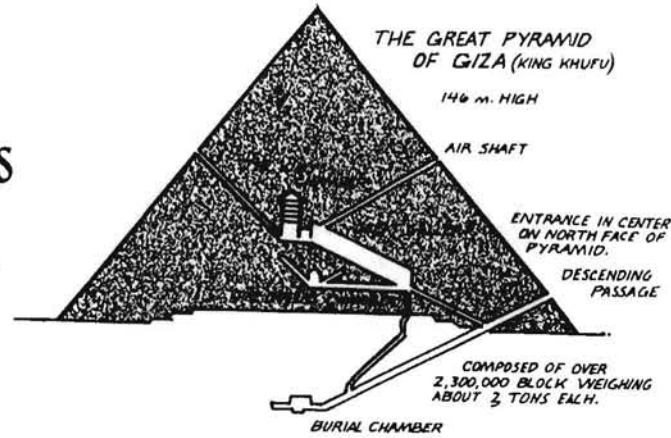
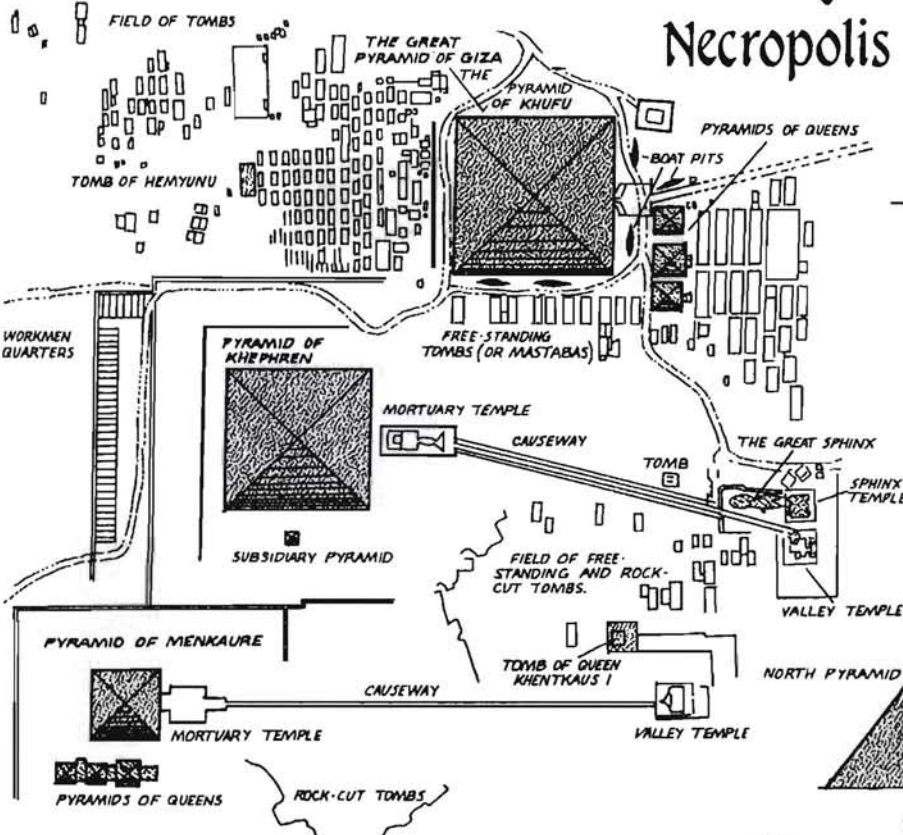

PYRAMID OF KHEPHREN

PYRAMID OF MENKAURE



THE THREE PYRAMIDS OF QUEENS NEAR THE GREAT PYRAMID

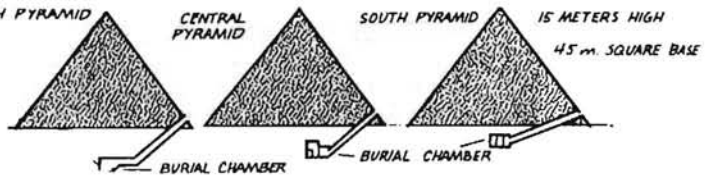



# The True Pyramid

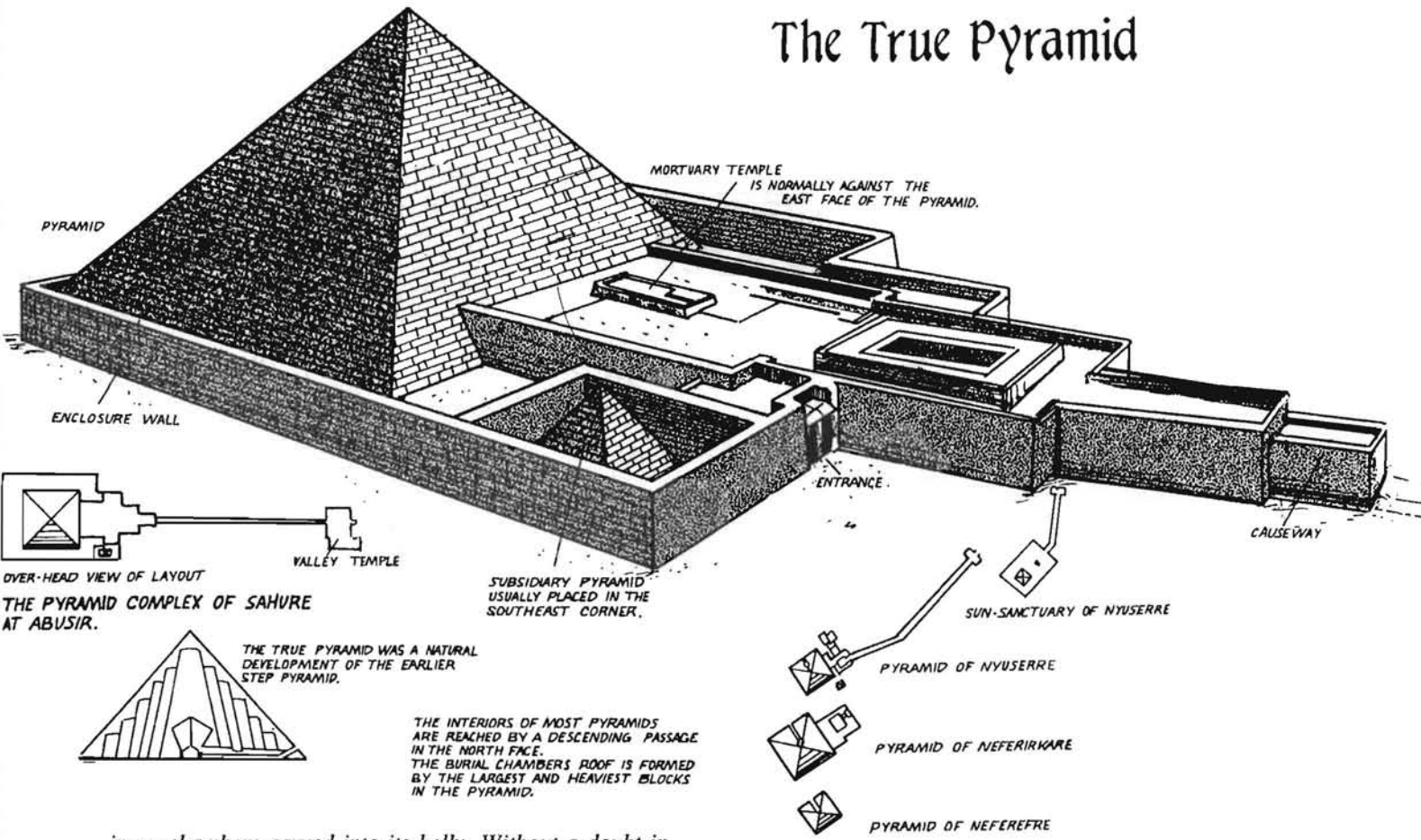

inner chambers carved into its belly. Without a doubt in my mind, I am certain that the Giza Necropolis was designed to utilize all three pyramids of power to create a circuit of geo-psychic energy. The two smaller would help fuel the largest. If pop-cultural theories are correct in that the configuration of the pyramid contains and stores a yet undiscovered energy, perhaps geo-psychic energy, the pyramid(s) would become a giant receptacle of geo-psychic power. The three tiny pyramids may have been reserve batteries, or perhaps a secondary line of defense if something unwanted slithered out of its giant brother pyramid. If my theory is correct, the Giza Necropolis may have been the greatest source of magic power ever built by man." Also see Maes Howe for cross reference.

**Note:** The ancient Egyptian and Babylonian mythology is one of the most colorful, with scores of demons, bizarre inhuman gods and magic. The legend of the mummy, the Jinn, powerful curses, the whispers of the sphinx, ghosts, haunted tombs, ghouls, and magic artifacts, seem to support Lazlo's speculation.

**GM Note:** Lazlo's theory is correct, as he so often is. Each of the three large pyramids are ley line nexus points. The three small pyramids and the Great Sphinx rest on ley lines, and the entire necropolis sits *within* the Mediterranean Triangle. Also note that the temple of Amun at Karnak is also a ley line nexus. The step pyramid marks a ley line.

# The Step Pyramid

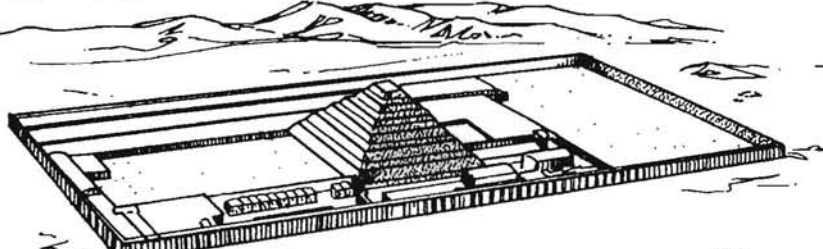
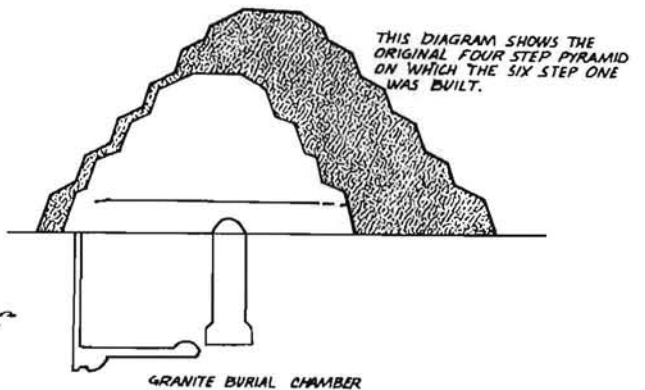
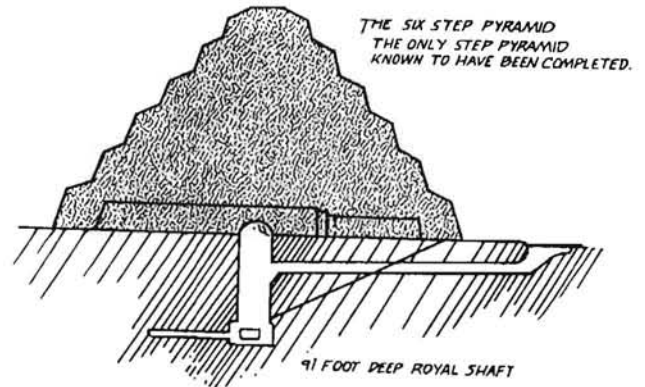



## Major Known Places of Power

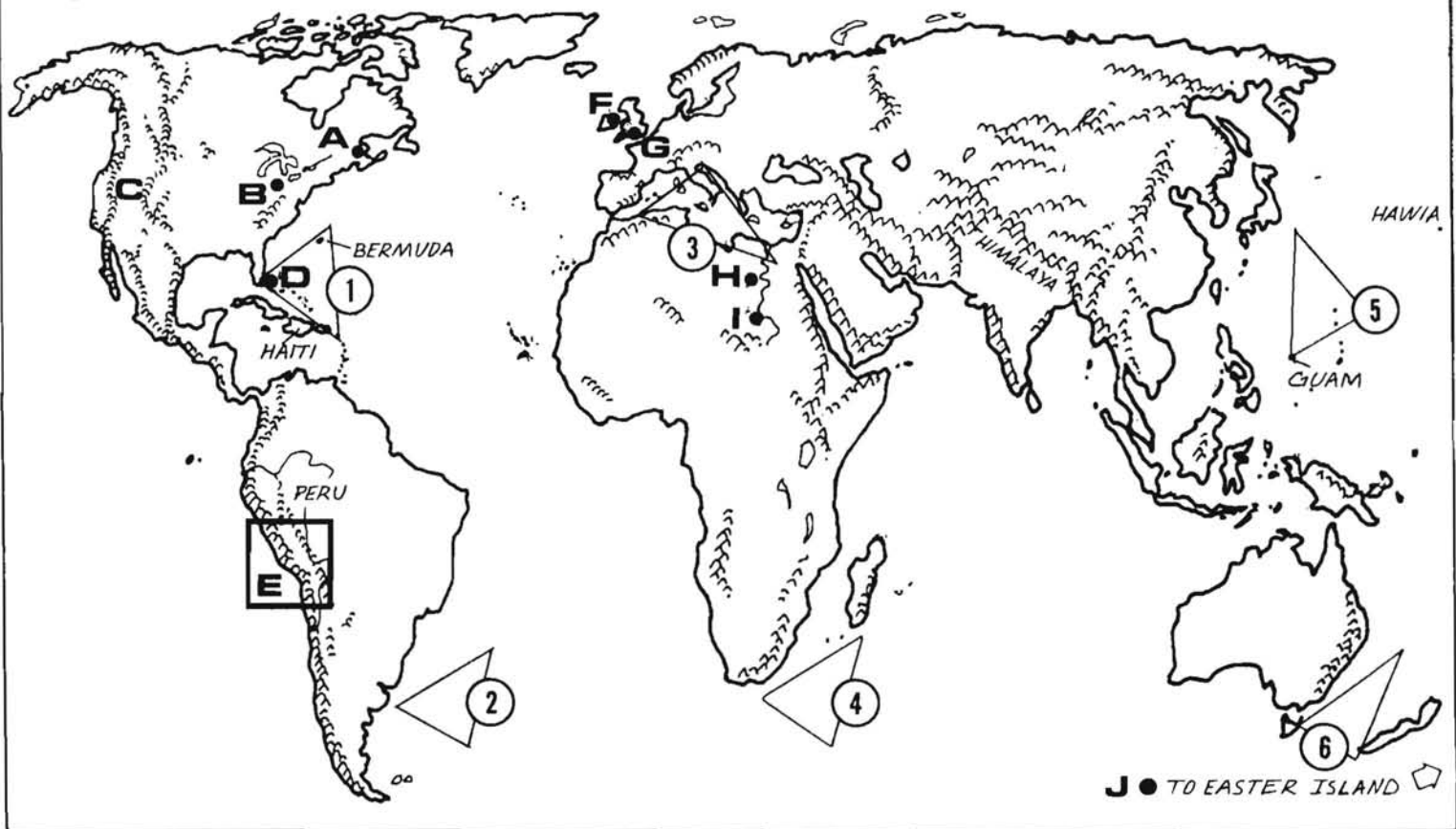

### GLOBAL MAP CODE KEY

1. *The Bermuda Triangle*
2. *The South American Triangle*
3. *The Mediterranean Triangle*
4. *The African Triangle*
5. *The Japanese Triangle*
6. *The South Pacific Triangle (Australia)*

- A. Mystery Hill (North Salem, New Hampshire)
- B. The Great Serpent Mound (Adams County, Ohio)
- C. The Desert and Stone Carvings of Colorado, Arizona and California.
- D. Bimini Island (in the Bermuda Triangle)
- E. Nazca and Atacama Deserts, the site of giant desert carvings. Note that Peru also contains several pyramids and the Andes Mountains.

- F. New Grange (Ireland)
- G. Stonehenge (England/the United Kingdom and home to dozens of other megaliths, mounds and standing stones).
- H. The pyramids of Giza (Egypt).
- I. The Temple of Amon-Ra, Karnak (Egypt)
- J. To Easter Island

### Other Megalithic Sites

- Teotihuacan, Mexico, near Mexico City (Ley Line Nexus)
- El Panecillo, Ecuador (Transitional Places of Power)
- Sacsahuaman, Cuzo (Ley Line)
- Malta's Temples (Ley Line)
- Easter island (Ley Line and Nexus)
- Standing Stones of Carnac France (Ley Lines)

THE IMPERIAL TEMPLE AT KARNAK WITH ASSOCIATED TEMPLE PRECINCTS

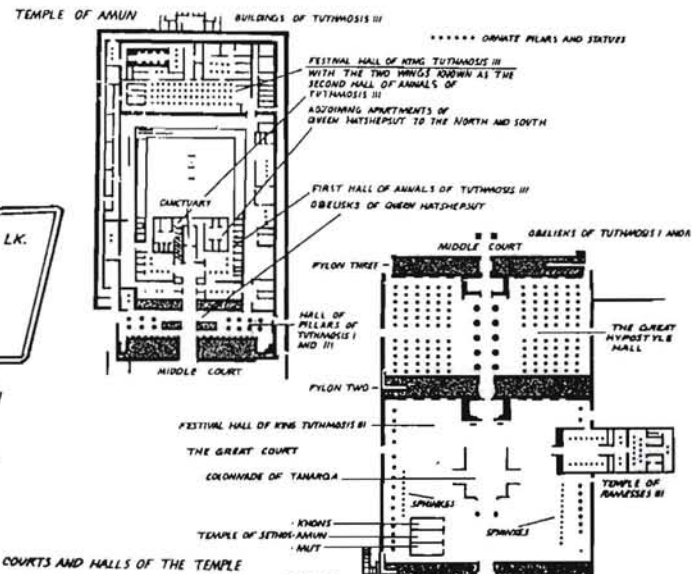
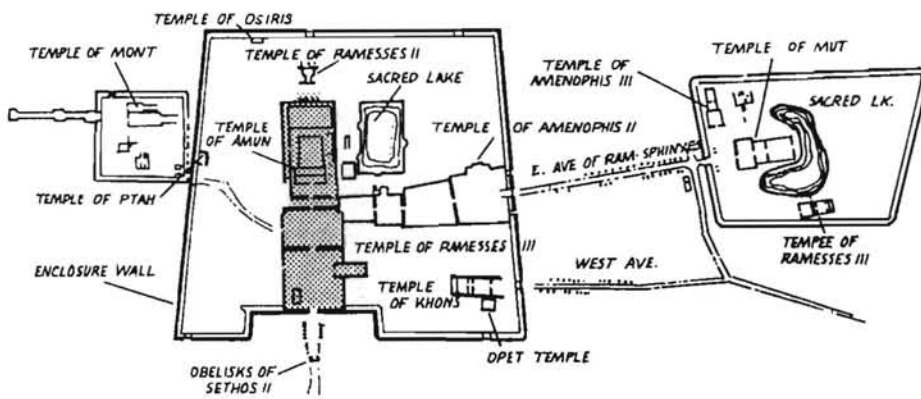



# THE MONSTER SECTION

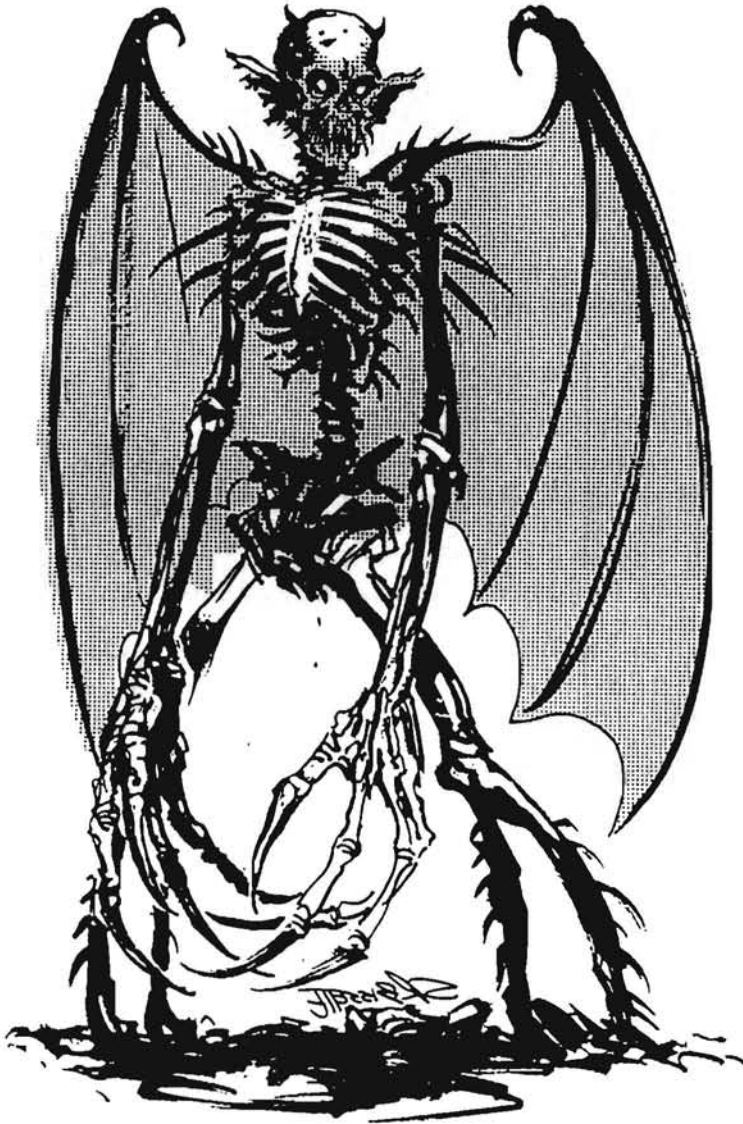

## Monsters in the Modern Age

An excerpt from Victor Lazlo's recently published diary, *The Final Words of Victor Lazlo*, © 1987.

"Modern man. What a proud peacock, so smug in his high-tech world. Safely nestled behind the sturdy walls of science. How we mock and sneer at the so-called 'primitive man' with his simple ways and foolish superstitions. We smile and suppress a laugh when the Australian aborigine explains that the drought has ended, because 'evil ones' have been driven away by the shaman. We cringe when we read about the blood sacrifices of the Aztec Indians and other ancient cultures. In our arrogance, we mutter under our breath, 'How pointless, how ridiculous. Just another of ancient man's obvious failings!'

"Snugly locked in our artificial world of concrete, steel, polymers, fibre optics, microwaves and dancing atoms, we look down at our past and try to forget foolish beliefs in magic and demons, luck and supernatural forces.

Knowledge, scientific 'truth,' that is modern man's ticket to salvation. An elitist attitude that blinds us to the 'ancient truths' that scream not to be ignored. Especially one fundamental truth; we are not alone. We have never been alone. And these 'others' are not our allies!

"Can it be that the Aztec's blood sacrifices, as cruel and, perhaps, wicked as they may have been, were used to draw on an enemy's mystic energy. An energy used by the Aztec priests and war chiefs to smite their enemy. Not pointless, not foolish, not some archaic superstition, but a shrewd, merciless means of attaining very real power. Is it possible that the aborigine shaman has chased away elemental demons, or more correctly, alien beings who can control our weather? Yes.

"Man may dominate this planet, but he is not yet its master. There are other beings who share the planet. Beings from other worlds. Creatures that feed on humankind like invisible, malignant parasites drinking our life's blood. Our forefathers had many names for them: demons, devils, evil spirits, vampires, werewolves, zombies, goblins, faeries, trolls, dragons, and on and on. Some are predators who simply hunt and feed on easy human prey. Others are cunning maleficent beings who delight in tormenting and abusing humans. Using us like pawns in some twisted, game macabre. Others are lost travelers, while still others are abominations of nature destroying all they encounter. They are real. They exist. Today! Now!

"It seems I have written these words a thousand times. I have given countless lectures and presented what I felt was conclusive evidence. But I seem to be waging an endless, futile campaign against a willful ignorance. The men of science, my colleagues, refute all evidence and brand me a charlatan or madman. For every question, they devise an answer, regardless of how foolish or contrived. They cling tenaciously to their laws of nature. Man-made 'theories' that they revere as a godsend. To the public they inspire trust, and ridicule, ever so cleverly, the existence of magic or the supernatural. They have created an environment where the mere concept of magic and supernatural forces, instantly relegated to the realm of fantasy. And those who claim otherwise are ignored as the insane or ignorant. A classic case of the blind leading the blind.

"It makes me so angry. Not that they besmirch my reputation, but that civilized man is walking, with open arms, to meet oblivion. How can I make people believe me? I have seen the creatures, fought them, banished them and bear their scars. But I can not get through. What then will be the fate of humanity.

"With each passing year I see the denizens of evil creeping into our cities. Creatures that once hid in wild, desolate places far from the reach of man are returning. They have realized that mankind no longer sees nor hears them. They know they have become shadows that can slip past us unobserved. 'They' have stayed so quiet for so long that



mankind doesn't recognize them for what they are, even when they are uncovered. They can stand bold-faced before the eyes of science and not be seen. Worse yet, they are beginning to realize that the old technology, 'their' technology, the ways of magic, are lost and forgotten. Armed with magic and evil intent, aided by the blind apathy of man, they return unopposed.

"I listen to myself and wonder. What will become of me and those handful of others who have unearthed some of the lost secrets, and do oppose these otherworldly invaders? Are we a threat or an occasional nuisance? Do we make a difference? And if we do make a difference, if our numbers grow and our voices begin to reach the masses, what then? Will any one of these nightspawned obscenities take notice and try to slay us? That is a question which has preyed on my mind a lot, lately. Perhaps it is just old age creeping up on me. Slowing me down. Still, I'd feel more secure if there were more of us. Otherwise, we'd be so easy to hunt down and terminate. Hell, would anybody even notice our disappearance?"

A diary excerpt written three months before the unsolved disappearance of Victor Lazlo.

## SUPERNATURAL CREATURES

The following pages contain a variety of supernatural creatures drawn from legend and imagination. Game masters may wish to supplement these monsters with additional creatures of their own design. Feel free to do so, but be careful not to imbalance your game. Ideas for source material can be found in the **Palladium Book of Monsters and Animals** (actually intended for our fantasy role-playing game), other games, mythology and books. You might be amazed at the wealth of stimulating books at your local library.

### LESSER SUPERNATURAL BEINGS

Banshee (H.F. 14)  
Boschala (H.F. 18)  
Burrowers (H.F. 12)  
Dar'ota (H.F. 15)  
Dimensional Ghoul (H.F. 12)  
Dybbuk (H.F. 14)  
Entity: Poltergeist (H.F. 10)  
Entity: Syphon (H.F. 10)  
Entity: Haunting (H.F. 14)  
Entity: Tectonic (H.F. 14)  
Entity: Possessing (H.F. 10)  
Garkain (H.F. 14)  
Gargoyle (H.F. 16)  
Gurgoyles (H.F. 14)  
Grave Ghoul (H.F. 12)  
Gremlin (H.F. 10)  
Hell Hounds (H.F. 16)  
Malignous (H.F. 16)  
Nacarant (H.F. 17)

Sowki (H.F. 14)  
Spider Demon (H.F. 16)  
Tokolosh (H.F. 12)  
UFO-naut (H.F. 9)  
Werewolf (H.F. 12)

## GREATER BEINGS Supernatural Intelligences

Elementals (H.F. 12)  
Goqua (H.F. 18)  
Mindolar (H.F. 16)  
Vampires (H.F. 14)  
Ancient Gods and Demigods (H.F. 18)

## THE BANSHEE

### The Harbinger of Death

The banshee is a low intelligence, P.P.E. vampire. Although legends sometime attribute its mournful wail with the power to paralyze or kill, the banshee is not that powerful. In actuality, the banshee is a psychic scavenger whose clairvoyant abilities enable it to sense the likelihood of death. Like a vulture, it is drawn by the psychic scent of death and waits.

At the instant of death, the potential psychic energy (P.P.E.) of all living creatures surges and doubles in magnitude and then drifts away. This is what the banshee has waited for! At that moment, the banshee is there to devour the energy. The creature does not use the energy for magic or any other purpose except food. Potential psychic energy (P.P.E.) is what it feeds on. Nothing else will sustain it.

The presence of a banshee does not automatically mean that there will be death or tragedy, but it does mean that the bizarre creature has sensed a very real possibility of death. If there is going to be a deadly event, it will usually occur within 72 hours of the banshee's arrival. However, the banshee is an impatient and eternally hungry creature. If a death doesn't occur within 10 hours, it will automatically exude a sensation of despair or sorrow. This powerful, undirected empathic transfer will affect everybody within 60ft (18.3m) of it. Note that the sorrow is not born from sympathy, but in that the foul being is, itself, feeling sad because nobody has died, and they are supposed to, and it is getting *so hungry*.

As it grows even more hungry and frustrated, the banshee begins to moan like a dog left out in the rain. The wail is a long, deep, mournful howl that can make a person's blood turn cold. Its frightful moaning will make everybody nervous and jumpy, especially if they know what it is.

A banshee will leave when the person(s) dies or it senses that death is not going to come this time. However, a banshee may wait as long as six weeks, especially if it senses a great deal of potential psychic energy. It can be driven away by exorcism, or intensely strong emotions of love or psychic combat. The banshee is a spirit-like being invisible except to psychics and arcanists who can see the invisible. They are vulnerable to telepathy, empathic transfer, bio-manipulation, astral beings and ectoplasm. *Magically*, they are vulnerable to exorcism, banishment, constrain being, commune with spirits, and summon lesser being.



# The Banshee

**Horror Factor:** 14

**Size:** 6 to 10ft tall.

**Weight:** Not applicable to spirit form.

**Armor Rating:** None

**S.D.C.:** 50 **Hit Points:** 50

**The Eight Attributes:** The number of six-sided dice are indicated. I.Q. 2, M.E. 1, M.A. 1, P.S. 1, P.P. 3, P.E. 1, P.B. 1, Spd. 4

**Natural Abilities:** *Ethereal*, which means it can walk through solid matter, like walls, and physical attacks, like bullets and fire, do no damage. *Hovers and floats* above the ground up to 100ft (30.5m) high. *Teleport self* only, up to 2000 miles (3218km), but only when going to a new feeding site. Natural state is *invisible* and it can not make itself visible. *Natural empath* — automatically feeling emotions (costs no I.S.P.).

**Other Abilities Include:** Clairvoyance, sense magic, and empathic transfer. The latter is the only way it can attack a creature of flesh and blood. Equal to a 5th level psychic.

**I.S.P.:** 100 **P.P.E.:** 10

**Attacks Per Melee:** 3 hand to hand with astral travelers only. Otherwise, it can only attack with empathic transfer once per melee. Note: Attacks *only* if it feels threatened.

**Bonuses:** None

# THE BOSCHALA

The boschala is a nightmarish creature from another world. Presumably, the monstrosity is a shape-changer that tries to make itself look like a creature from our world, except that it has no perception of how life-forms function in our dimension. Consequently, the boschala will appear as a mass of animal parts and human features. It may, for example, have the head of a human, the body of a worm, bat wings, eight spider legs, and a crab claw. Undoubtedly, mythical creatures such as the chimera, with the head of a lion, body of a goat and tail of a dragon, was a boschala. Each boschala that enters our world will assume a different form. The only time a character will find two or more of identical appearance is when the creatures have entered into our world at the same time. In such a case, the things will all imitate the same appearance.

The boschala are carnivorous predators, but their awkward selection of body parts and size makes them easily recognizable and impairs their natural speed. Yet it is not the creatures' combat abilities that makes them attractive to evil arcanists. The boschala possess high reserves of potential psychic energy (P.P.E.) that can be tapped when two or more are available. The hideous things can also physically merge together to become one. When this occurs, the mage can link with the things by touch, or draw on the combined potential psychic energy. When summoned through a summon lesser being pentagram, the creatures will respond to the summoning mage like obedient misshapen puppies.

There is only one danger in summoning the boschala and that's summoning too many. Whenever 13 or more are together, they are compelled to mate. It is a repulsive, horrific scene in which all the boschala merge and flow together in one twisted mass of undulating flesh and limbs. The entire process takes a mere 30 minutes. When they withdraw, becoming separate beings again, there will be one additional, full-grown boschala.

This process can be repeated once every 24 hours. Furthermore, the mage can not control 13 or more. They will not attack him (unless he attacks one of them), but they will completely ignore him. Worse yet, the birthing process depletes them of all P.P.E.

The following tables will allow game masters to compose one of these abominations with relative ease.

## FIRST: Roll for Main Body Type

1-8	Humanoid
9-15	Canine
16-22	Worm
23-29	Feline
30-36	Slug
37-43	Horse
44-50	Bull
51-57	Rhinoceros
58-64	Elephant
65-71	Lizard
72-78	Spider
79-85	Insect
86-93	Snake
94-00	Bird

## SECOND: Roll the Number of Heads

1-20	Four
21-40	One
41-60	Two
61-80	Three
81-00	Five

## THIRD: Roll for the Appearance of Each Head

1-10	Goat
11-20	Dog
21-30	Lizard
31-40	Fly
41-50	Human
51-60	Cat
61-70	Monkey
71-80	Spider
81-90	Rat
91-00	Bull/Cow

## FOURTH: Roll for Number of Legs

1-20	Two
21-40	Three
41-60	Four
61-80	Six
81-00	Eight

## FIFTH: Roll for the Type of Legs. Each roll represents a pair of legs.

1-12	Human
13-24	Feline
25-36	Horse
37-50	Insect
51-62	Canine
63-75	Lizard
76-87	Rhino/Elephant
88-00	Spider



**SIXTH: Roll for the Number of Arms**

- 1-20 Two
- 21-40 Three
- 41-60 Four
- 61-80 Five
- 81-00 Six

**SEVENTH: Roll to Determine the Type of Appendage for Each Arm.**

- 1-25 Human Hand and Arm.
- 26-50 Crab Claw
- 51-75 Tentacle, like an Octopus
- 76-00 Ape Hand and Arm.

**EIGHTH: Tail(s), if any.**

- 1-35 One
- 36-71 Two
- 72-00 None

**NINTH: Type of Tail; roll for each.**

- 1-20 Monkey
- 21-40 Lizard
- 41-60 Feline
- 61-80 Dog
- 81-00 Bunny

## The Boschala

**Horror Factor:** 18

**Alignment:** Anarchist or any evil.

**Size:** 8 to 15ft (2.4-4.6m) tall or long.

**Weight:** 500-2000lbs (226-904kg).

**Armor Rating:** 8

**S.D.C.:** 100 **Hit Points:** 60 + 1D4 × 10.

**The Eight Attributes:** The number of six-sided dice are indicated. I.Q. 1, M.E. 3, M.A. 2, P.S. 6, P.P. 3, P.B. 1, Spd. 2

**Natural Abilities:** Nightvision — 100ft (30.5m), track by smell — 70%, normal day vision, see the invisible, impervious to poisons/toxins/drugs/gases, bio-regeneration of 1D6 hit points and 4D6 S.D.C. per hour.

**I.S.P.:** None **P.P.E.:** 1D4 × 10.

**Attacks Per Melee:** 3, regardless of the number of heads and arms. Inflicts 2D6 damage (plus P.S. bonus) or by hand-held weapon. It can use guns if it has a human hand and arm, but is (minus) -6 to strike. **Note:** The boschala is more animal than intellect, and functions with the cunning and instincts of a predator.

**Bonuses:** +1 to strike and parry, +1 on initiative, +3 to save vs magic. The boschala is vulnerable to all physical attacks, fire, magic and psychic powers.





## BURROWERS

A horrible little creature is the burrower, a weird parasite that feeds on human brain tissue and potential psychic energy. The creature is an eel-like thing with scores of hair-like tentacles which they use to move and grab/hold objects. The creature's body measures about six to eight inches long (152 to 203mm), with its hair fibers being of equal length.

A burrower has no natural defenses or powers, thus it usually attacks sleeping or helpless victims. What it does is climb up to the head, then wraps its hundreds of tough hairs around the person's head and hair, and begins to secrete an acid from its mouth to burn a hole into the skull. The process is quite painful, but takes only about two minutes (8 melees) to complete. The burrower then releases the head and slithers into the hole. Inside the skull it secretes another substance that plugs the hole and anesthetizes the brain. At this point its victim is beyond help. The burrower will completely devour half the brain within one hour, but that is when things get really strange. The burrower can temporarily control its victim's body. It can walk, run, climb, talk, see, use simple tools and devices, drive a car and perform some skills. Apparently the creature is somehow, temporarily linked to the brain and can control the body. Its odd telepathic nature enables it to absorb the character's skills and fragments of memory. All skills are limited to what that particular person knew and are - 30%. Memory is limited to tiny bits and fragments, like a 10,000 piece jig-saw puzzle that is missing 9800 pieces. The burrower and body can sustain this condition for 72 hours before the body gives out and the telepathic link fades. The burrower will then finish eating and exit within 12 hours. It will need to feed again every six or seven days. Fortunately, burrowers are extremely rare in our world and easy to kill.

### The Burrower

**Horror Factor:** 12

**Alignment:** Considered evil.

**Size:** Eel or snake shaped, 6 to 8 inches long.

**Weight:** 8 ounces (226 grams).

**Armor Rating:** 1

**S.D.C.:** 10 **Hit Points:** 5

**The Eight Attributes:** The number of six-sided dice are indicated. I.Q. 1, M.E. 1, M.A. 1, P.S. 2, P.P. 2, P.E. 1, P.B. 1, Spd. 1

**Natural Abilities:** Animal intelligence, prowl — 79%, climbing — 80%, nightvision — 50ft (15.2m), day vision — 50ft, and a natural telepath (costs no I.S.P.).

**I.S.P.:** None **P.P.E.:** 4

**Attacks Per Melee:** Two; acid bite does 1D4 damage. It is vulnerable to all attacks, psychic, magic and conventional.

**Bonuses:** +1 to strike, +3 to dodge, no parry.

## THE DYBBUK

### The Demon Ghoul

One of the most horrifying demons of the ancient world was the Dybbuk, "Eater of Flesh." According to legend, a power mad necromancer opened a doorway to the dybbuk world and summoned an army of the savage creatures to destroy his enemies. Unfortunately, he greatly underestimated their power and became their first human victims in a millennium. An untold

number of dybbuk came through the portal before it collapsed and have spread across the world. They have wreaked havoc throughout the centuries, plundering graves, inciting disasters and tormenting the helpless.

The dybbuk loathe humankind and delight in its torture. Consequently, a dybbuk will frequently work with an evil arcanist or other maleficent forces to cause mayhem and inflict agony. These demonic beings are intelligent, cunning and deadly, capable of learning human skills to destroy humankind. Despite their wiles, they are extremely intolerant of their own kind and will squabble and bicker incessantly whenever two or more are forced together. For this reason, they shun the company of their own race.

The dybbuk can not tolerate the light of day, which completely blinds them and physically hurts (1D4 damage per minute of exposure). As a result, the sinister creatures venture out only at night or rainy, overcast days.

In years gone by, the dybbuk would inhabit slums, ancient ruins and graveyards. Today the dybbuk have claimed the new ruins of the modern city; the graveyard of *abandoned* buildings and slums that seem to be found in most major cities. They quietly prowl the inner city streets to find their prey, the young, the infirm, the helpless old, and the dead. For while these fiends' favorite food is dead, rancid meat, they have grown to enjoy the taste of fresh human flesh almost as much.

The natural form of the demon-ghoul is a massive, barrel chested humanoid with no neck, vaguely human head, bald, and large maw rimmed with a double row of pointed teeth. In place of the arms are a pair of oversize limbs, like those of an ape, thickly muscled, with massive, clawed hands, like shovels, that drag across the ground. These arms are used to dig up the graves of the dead. Tucked under them is a second pair of arms. Spindly and delicate, a little shorter than a human's, and half as thick. The hands are small, with long fingers tipped with four inch long, razor sharp claws. It is these that the repulsive creature uses to dismember its food and feed itself.

There is one more aspect about the dybbuk that makes it ever more so dangerous. The damnable thing can physically inhabit the recently deceased. If the body is not badly damaged and it is one hour or less since the time of death, the dybbuk can incorporate itself and enter the dead body. Immediately, the body will come to life, possessed by the demon-ghoul. The memories, skills, personality and essence of the person are all *gone*. It is an empty, lifeless husk that the dybbuk now inhabits. A perfect disguise to walk among humans. It can maintain the body, without it deteriorating, indefinitely, as long as it feeds daily on human blood.

### Dybbuk

**Horror Factor:** 14

**Alignment:** Diabolic or miscreant.

**Size:** 6 to 8ft (1.8-2.4m) tall.

**Weight:** 400 to 700lbs (181-317kg).

**Armor Rating:** 4

**S.D.C.:** 100 **Hit Points:** 2D4 × 10

**The Eight Attributes:** The number of six-sided dice are indicated. I.Q. 3, M.E. 4, M.A. 2, P.S. 5, P.P. 4, P.E. 3, P.B. 1, Spd. 3



**Natural Abilities:** *Superior nightvision* — 600ft (183m), and blind in the daylight (–8 to strike, parry and dodge). Artificial light is hard on the eyes — 30ft range of vision without sunglasses. *Can dig* through packed dirt or clay at a rate of 6ft (1.8m) per minute, and almost always constructs a network of tunnels in its lair to escape intruders.

**Other Abilities Include:** Enhanced healing (heals three times as fast as a human), impervious to cold, fire resistant (fire does ½ damage), track by smell — 85%, prowl — 50%, and can learn 2D4 human secondary skills equal to third level proficiency.

**I.S.P.:** None **P.P.E.:** 4D6

**Attacks Per Melee:** Six; big claws do 2D6 damage plus P.S. bonus, the small arms are used like knives and do 2D6 damage, but *no* P.S. damage bonus. Bite does 2D4 damage. *In a human body, it has four attacks per melee* and retains its attributes and bonuses, but a human punch does only 2D4 damage (plus P.S. bonus, if any).

**Bonuses:** In addition to probable attribute bonuses, the dybbuk is +1 to parry and dodge, and +4 to save vs magic. It is vulnerable to conventional weapons, psychic attacks and to a lesser degree, fire (does ½ damage) and magic. The light of day inflicts 1D4 damage per minute of exposure.

## DIMENSIONAL GHOUL

The dimensional ghoul is a tall, thin humanoid which, in dim light and at a distance, may be mistaken for a human. A closer look will reveal its long, jagged teeth, sunken eyes, and sagging, grey skin hanging off a skeletal, thin body. Like all ghouls, the creature feeds on the flesh of the dead. A true scavenger, it will eat any dead animal, but prefers the taste of human flesh above all others.

Although fairly intelligent, the dimensional ghoul is more mischievous and curious than vindictive or cruel. Unlike the dybbuk, it has no deep-rooted hatred for mankind. It just likes to eat them when they die. However, one should not assume that they are any less dangerous. The dimensional ghoul will maim or kill in an instant if it feels threatened, hurt, or is disturbed while eating.

The dimensional ghoul is so named because it has the power to move from dimension to dimension through any ley line nexus point. If a mage can control it, the ghoul can be commanded to take one living, man-sized creature with it into another dimension. The problem with this method of dimensional travel is that the process is excruciatingly painful to humans (inflicts 1D6 × 10 damage) and the mage will lose any mystic control he may have had over the ghoul the moment they reach the new dimension. Of course, there are countless dangers and environmental problems when traveling through dimensions randomly.

## Dimensional Ghoul

**Horror Factor:** 12

**Alignment:** Anarchist or any evil.

**Size:** 6 to 10ft tall (1.8 to 3.0m); very thin, skeletal.

**Weight:** 150-290lbs (67kg to 131kg).

**Armor Rating:** 6

**S.D.C.:** 2D4 × 10 Hit Points: 80

**The Eight Attributes:** The number of six-sided dice are indicated. I.Q. 3, M.E. 4, M.A. 3, P.S. 4, P.P. 4, P.E. 4, P.B. 1, Spd. 4



**Natural Abilities:** See the invisible, nightvision — 200ft, normal day vision, fire and cold resistant (do half damage), prowl — 80%. Of course, the ability to *dimensional travel* through ley line junctions is a natural ability. Along with this ability are two other powers that work hand in hand with the former. 1) *Sense Ley Line P.P.E.:* The ghoul can sense huge amounts of constant potential psychic energy flows indicative of places of power. **Range:** 150 miles (240km). 2) *Temporal intangibility:* To avoid the agony of the dimensional teleport, the ghoul can momentarily become intangible. It can do this at will at any time. **Duration:** 30 seconds (2 melees); as often as once every two minutes. **Range:** Self only. Impervious to *all* attacks while intangible, but can not move during that 30 second period.

**I.S.P.:** 500 **P.P.E.:** 20

**Attacks Per Melee:** Three: claw or kick — 2D6 damage, bite — 2D4 or by weapon. The dimensional ghoul can use any type of weapon, from club to sub-machinegun. However, it will only use whatever weapon it finds handy, laying around.

**Bonuses:** In addition to possible attribute bonuses, the creature is +2 to save vs psychic attack, +3 to save vs magic, +10 to save vs horror factor.



# DAR'OTA

## The Succubus and Incubus

In their natural, "true" form, the Dar'ota are large, slimy, scaly, hunchbacked humanoids that resemble a cross between a human and monstrous lizard. The head is a huge, misshapen bag of flesh with a gaping mouth loaded with fangs three to six inches long (76 to 154mm). What makes these creatures so dangerous is their ability to shape-change into an attractive human, seduce its victim and kill him or her, tearing out the throat and drinking the blood.

Many cultures have myths about the succubus (female) and incubus (male); shape-changing demons who would charm and seduce unsuspecting humans for the purpose of manipulation, torment, or murder. They are cruel, maniacal beings who enjoy abusing humans in every possible way. The dar'ota will often ally themselves with a wicked arcanist or other dark force to promote pain and suffering. Vampire-like, the beings must feed on blood, preferably human blood, every two days.



In human form, the creature will have the beauty and appeal of a movie star. Only the person's inhuman strength will hint that something is amiss. The dar'ota can remain in human form for days, but must revert to its monstrous shape to feed (every 2 days) and when engaged in prolonged combat (more than two minutes/8 melees). They are lethal combatants in either form, but devastating as a lizard-thing. It is important to point out that all dar'ota are psychotic killers who love to hurt and murder.

# Dar'ota

**Horror Factor:** None as a human, 18 when the transformation from human to monster is witnessed, 15 as lizard-thing.

**Alignment:** Diabolic or miscreant.

**Size:** 5 to 6ft tall (1.5 to 1.8m).

**Weight:** 300 to 600lbs (136 to 272kg).

**Armor Rating:** 12; tough, scaly skin.

**S.D.C.:** 100+1D6×10 **Hit Points:** 2D4×10

**The Eight Attributes:** The number of six-sided dice are indicated. I.Q. 3, M.E. 3, M.A. 5, \*P.S. 5, P.P. 4, P.E. 4, \*\*P.B. 1/6, Spd. 5

\*Minimum strength is 18

\*\*Physical beauty as the creature is 1D6, but in human form — 6D6. The minimum P.B. is 18.

**Natural Abilities:** *Shape-change* into adult human form only.

*Naturally tough skin* provides protection against many physical attacks when in lizard-thing form (A.R.: 12). Nightvision — 60ft (18.3m), normal day vision, resistant to fire and cold (does half damage).

**Magic Abilities:** Spell only; equal to 4th level arcanist, which means a 13 or higher is needed to save vs magic. *Spells include:* Death trance, sense evil, concealment, befuddle, calling, and charismatic aura.

**I.S.P.:** None **P.P.E.:** 1D6×10

**Attacks Per Melee:** Three; claws do 2D4 plus P.S. damage bonus, bite does 3D6 (no P.S. bonus applies), or by weapon.

**Bonuses:** In addition to attributes bonuses, +1 to save vs magic, +10 to save vs horror factor.

## ENTITIES

An entity is a supernatural energy being that is *invisible* to the human eye. Consequently, it is the entity who has become known as ghosts, spirits, wraiths, specters, and similar non-corporeal apparitions. There are five major types of entities, each uniquely different from the others. They are: 1) The Poltergeist, 2) The Syphon or Trapped Entity, 3) Haunting Entity, 4) Tectonic Entity and 5) Possessing Entity. All are potential psychic energy (P.P.E.) vampires.

### THE POLTERGEIST

*The poltergeist*, known as the mischievous spirit, is a wild, wandering, supernatural force with a minuscule intelligence. The odd little energy thing flies about looking for a good source of potential psychic energy to feed upon. It is especially attracted to families with children, psychics, arcanists and places of power. Once such a place (not just a person) is found, the poltergeist settles in for the long haul. This is its home, its dwelling. It is almost oblivious to the activity of the humans who share its home. The poltergeist's only interest in the human occupants (animals too) is as a source of food and play.

Despite what you may be thinking, the poltergeist's syphoning of potential psychic energy from humans is painless and harmless (unless you're a mage who needs his P.P.E. for magic). One poltergeist only absorbs 1D4 points of P.P.E. per day. Even if it drained all the P.P.E. it would not harm the humans, except to make magic and psychic abilities impossible. The human's don't feel a thing. In fact, nobody would ever realize that a poltergeist was present.



However, poltergeists are very rambunctious critters and that's where trouble comes in. The dopey creatures love to play, and who better to play with than the dinner. Furthermore, the poltergeists can drink in the humans emotions (empathy). Intense emotions, such as anger, love and fear is tantalizing to the mischievous spirits, almost like a drug high. It's only a matter of time before they realize that *fear* is the only emotion that they can cause in humans, so that's the one they use. It's so easy too. Humans get scared over the smallest things, banging in the middle of the night, doors opening by themselves, china flying across the room and so many other innocuous things, send them screaming and running from the room. Great fun and a buzz too!

Of course, humans have no idea about what's going on and are far from amused. A poltergeist is not cruel or sadistic, only stupid and frisky, but a potentially deadly combination in this case. Like elementals, the poltergeist really doesn't understand these alien lifeforms called humans and animals. Consequently, while they will not intentionally hurt anybody, they can do so by accident. They don't realize that telekinetically hurling cutlery could kill somebody, or that dropping a chandelier on top of a person could kill him or that pushing old gramps in his wheelchair down the stairs could have deadly repercussions. Fortunately, for the most part, poltergeist stick to small pranks, like hiding keys, unlocking doors, stealing socks, knocking over things, floating objects in mid-air, knocking and other antics. There are one or two more bits of bad news about poltergeists. First, they tend to travel in packs of 2 to 8 and are always ready to welcome more. Second, once they find a nice home they hate to leave.

**Getting rid of a poltergeist** is easier than getting rid of most supernatural beings. Magically, an exorcism will send them scurrying, constrain being, control and enslave entity, summon entity, immure entity and banishment are all powerful means of controlling them. Commune with spirits will enable the arcanist to talk to them and perhaps convince them to leave. A psychic sensitive can use telepathy, empathy, empathic transfer and a few other means to convince them to vacate a premises. *Poltergeist are vulnerable* to all magic and psychic attacks. They are impervious to physical and energy attacks, gases or drugs. Vacating a premises for several months may send the hungry little buggers away, providing there is no other available source of potential psychic energy (35% chance of success). Destroying the dwelling and leaving the area is even more successful (79%), but a little extreme.

## ENTITY: POLTERGEIST

**Horror Factor:** 10

**Alignment:** Anarchist

**Size:** About the size of a soccer ball; energy sphere.

**Weight:** None

**Armor Rating:** None

**S.D.C.:** Not applicable **Hit Points:** 4D6 + 10

**The Eight Attributes:** Not applicable.

**Natural Abilities:** Invisible is its natural state, fly and hover, maximum speed possible is 30mph (48kmph), intangible which means it can pass through solid matter (but not through energy), and never tire.

**Psychic Abilities:** Empathic receiver meaning it feels the emotions of others (automatic and costs no I.S.P.), see aura, see the invisible, sense magic (P.P.E.), levitation and telekinesis. Equal to 4th level psychic.

**Attacks Per Melee:** Two with telekinesis or levitation only.

**Bonuses:** +2 to dodge, +10 to save vs horror factor.

**I.S.P.:** 10 **P.P.E.:** 4

**Note:** As a psychic vampire a poltergeist draws on the I.S.P. of the people around it to perform its psychic feats. If there is no I.S.P. available (or used up) the creature will draw on the people's and animal's P.P.E. and convert it into usable psychic inner strength points (I.S.P.) at a rate of FOUR I.S.P. per every *one* point of potential psychic energy (P.P.E.).

Poltergeist are fairly common because a few enter into our dimension every time a dimensional portal is opened or a natural dimensional rift occurs at a ley line, power triads or nexuses. They also sneak in whenever an arcanist uses a summon lesser or greater being ritual.

## THE TRAPPED ENTITY OR SYPHON

*The syphon* is an evil entity that inhabits inanimate objects. Immediately upon inhabiting an object the entity is trapped, forever imprisoned, until the object is destroyed. Such creatures inhabiting dead trees, and rocks are probably responsible, along with elementals for legends of "earth spirits" and faerie folk. It is also the syphon that is responsible, in part, for legends of magic amulets and mystic artifacts to be empowered by demons. The syphon can inhabit any type of non-living matter, except plastic, from rings and medallions to mirrors, walking sticks and automobiles.

The trapped entity lays dormant in a state of suspended animation until the presence of a creature, or creatures, with sufficient potential psychic energy (20 or higher) awakens it. Like the poltergeist, the syphon feeds off the host creature(s) requiring 20 P.P.E. to become fully awake and 10 P.P.E. or more every day (it's a glutton). Unlike the poltergeist, the syphon's intentions are far from playful or innocent.

The syphon entity is a diabolical fiend that delights in manipulating, corrupting and destroying humans. A common practice of the syphon is to sense a corruptible individual and make telepathic contact. After initial contact it will weave a fantasy story about being a powerful source of magic or power, it then plays upon the persons greed, lust for power, desire for revenge, and other exploitable weaknesses. In exchange for its aid the horrid creature often demands regular blood sacrifices to be made in its presence. This way the gluttonous fiend can absorb all the doubled P.P.E. of the murdered victim, kill an innocent human and morally destroy its human pawn of evil (who it will finally push to the brink of suicide, or madness).

The syphon is a diabolically cunning creature who is patient and calculating. It does not worry about what will happen if its pawn is killed, because there is always another. That person may be found an hour, a week or a decade later; it doesn't matter to the syphon. Time has little meaning to this eternal evil force. When nobody is available it simply sleeps. The entity would rather inhabit a small portable object to be among humans than at a ley line nexus, or ley line, where it would be constantly awake and fed, but terribly unfulfilled.

Although tougher than the poltergeist the syphon is vulnerable to the same mystic and psychic forces. An exorcism or banishment will set it free of the object and force it to leave the area to find a new object to inhabit. The syphon entity must find an object to inhabit within one hour or be spirited back to its own world. In its freed energy form, the entity is vulnerable to all



forms of magic attack, but is still impervious to physical and normal energy assaults. Psychic powers are always an effective weapon against a syphon, in and out of the object. Destroying the object it inhabits will force it to flee the immediate area (100ft/30.5m) to find a new home. **WARNING:** The syphon is far more capable and willing to defend itself than a poltergeist. One of its weapons will be the human pawn(s) it has under its control.

## ENTITY: SYPHON

**Horror Factor:** 10

**Alignment:** Diabolic or Miscreant

**Size:** About the size of a soccer ball as an energy being, but can inhabit an object as small as a ring and as big as a 50ft (6.1m) dead tree.

**Weight:** Not applicable.

**Armor Rating:** None

**S.D.C.:** That of the object it inhabits.

**Hit Points:** 1D6 × 10 + 30

**The Eight Attributes:** Not applicable, but very cunning, intelligent and ruthless; equal to an I.Q. of 14 or 15.

**Natural Abilities:** Able to possess/inhabit non-living objects.

Note that this does *not* enable the entity to animate or move the object through any means other than telekinesis. In energy form it can hover and fly at a maximum speed of 30mph (48kmph) and is intangible, which means it can pass through solid objects. Its natural state is invisible. The syphon is also a natural telepath, which means it expends no I.S.P. during telepathic communication.

**Psychic Abilities:** Empathy, empathic transmission, mind block, divination, presence sense, see aura, see the invisible, sixth sense, levitation, bio-manipulation and suggestion (hypnosis). Equal to a 6th level psychic.

**Attacks Per Melee:** Two, psychic attacks only.

**Bonuses:** +2 to dodge (as an energy being), +2 to save vs magic, +1 to save vs psychic attacks, +15 to save vs horror factor.

**I.S.P.:** 20 **P.P.E.:** 6

**Note:** The syphon will use its own 20 I.S.P. only when it has no choice. As a psychic vampire a syphon draws on the I.S.P. of the people around it to perform its psychic feats. If there is no I.S.P. available (or used up), the creature will draw on the people's and animal's P.P.E. and convert it into usable psychic inner strength points (I.S.P.) at a rate of FOUR I.S.P. per every *one* point of potential psychic energy (P.P.E.).

## THE HAUNTING ENTITY

### The Classic Ghost

A haunting entity is sort of a misguided and confused psychic bloodhound. Although we can not see it, we leave a psychic impression wherever we have been. Our homes and work places hold the strongest emanations, because that is where we spend most of our time. Generally, the psychic impressions fade or are so weak that they are imperceptible. However, strong emotions, such as intense hatred, love, desire, anger, sorrow and so on, leave a deep, lasting mark. A psychic impression that the haunting entity sees and feels in every way. This entity is like a psychic sponge with no identity of its own. It is drawn to the emotions of others, old emotions from the past, and languishes in them.

Since only the strongest emotions are perceivable, the entity experiences only the most intense, traumatic, painful, frightful, or happy events. Little snatches of life gone by. The entity will find the very strongest of these emotional events and play it back over and over again, becoming absorbed in it. This is where the trouble can arise. Because the entity has no self identity it gets confused and thinks that "it" is the central person of the recorded psychic impression. Locked in that memory, the entity becomes a shadow of that person. An intangible apparition of the past. In every sense of the word, a ghost.

The haunting entity becomes so completely a part of the memory that it believes it is that person and will reenact that fragmented memory endlessly. This is why the same haunting ghosts are so often reported to be repeating the same one or two events. This is the ghost who is always seen at the same place sobbing, or the ghost that always appears walking the same forlorn corridor. Haunted places are often inhabited by poltergeist too, because the ghost radiates the intense emotions the poltergeist enjoy so much.

**Getting rid of a haunting entity** can be surprisingly easy or incredibly difficult. Since it is bound to that specific person and memory, sometimes it can be *fooled* into leaving. Most ghosts will be reliving tragic or personally painful events. If the human(s) can resolve its pain or fear or worry, the entity will be set free of the tumultuous memory that locked it there in the first place. Satisfied it will leave and once gone, the emotions fade and it sets out in search for new experiences to share. **For Example:** If the person was murdered, the entity may not leave until it can be proven that the culprit was captured and punished. Another example might be a case of regret and unfulfilled promises, like: Dear sweet, Auntie Ann wanted her favorite niece to have a special token of her affection (a book, a broach, hand knitted scarf, or whatever), but died before she could do so. Thus, if the characters could give the woman the gift the ghost would be happy and leave. The elaborateness of the mystery or promise is strictly up to the game master. It can be laced with evil and intrigue or completely innocent or soap-opera melodramatic (Auntie Ann's book is found, presented to the niece and is discovered to be a rare first edition. Or the niece knows that Auntie forgave her for some altercation).

In some cases there will be no solution to trick the entity into leaving, thus, more direct means will be required. Exorcism probably has the best chance for success. Commune with spirits, banishment, control and enslave entity, and summon entity are also useful magic against a haunting spirit. The psychic sensitive is the ideal person to identify, locate and communicate with the being through presence sense, clairsentience, see the invisible, sense evil, empathy and telepathy. A haunting entity is vulnerable to magic and psychic attacks only, but is certain to defend itself.

## THE HAUNTING ENTITY

**Horror Factor:** 14

**Alignment:** By nature this entity is the closest thing to a true neutral as possible. It simply wanders the world without a care, desire, hope, dream aspiration or involvement in anything. We'll call it a passive Anarchist. However, the haunting entity that is caught in a memory will believe itself to be that person and assumes his or her alignment. This can make the ghost friendly or dangerous.





An evil or vengeful persona will compel the entity to react in kind. It will see living humans as the persons of its disdain and attempt to extract its vengeance or inflict its evil on each and every person who dares to invade its domain. This means if the deceased was an axe murderer, so is the ghost. If the memory it has absorbed is hatred; the ghost will be hateful, mean and potentially deadly. Fortunately, these ghosts will always leave hints as to their intentions and motives.

Ghosts of a good alignment, on the other hand, are not overtly hostile, but will scare the dickens out of a person with sudden appearances, moans, groans, sobbing, singing, whispers, footsteps, floating objects, icy touches and so on. The entity does not mean to scare anybody, its just perpetually reliving its imagined life. An entity of a good alignment may even be friendly or helpful and warn characters of evil forces

or impending danger. Of course, since the entity has no identity of its own, it has been good, evil, and selfish many times. It simply becomes the person in the psychic memory impression.

**Size:** Human

**Weight:** None

**Armor Rating:** None

**S.D.C.:** None **Hit Points:**  $1D6 \times 10 + 30$

**The Eight Attributes:** Not applicable, but may exhibit the abilities of the deceased person it believes itself to be.

**Natural Abilities:** Ethereal and intangible, meaning it can walk through solid matter. Its natural state is invisible, but can, for brief moments (3D4 minutes) become visible to the human eye either as a semitransparent ghost image or completely solid and apparently real (ectoplasm). The entity can



also hover and fly at a maximum speed of 20mph (32kmph).

It is impervious to all physical and energy attacks.

**Psychic Abilities:** Empathy, empathic transmission, mind block, see the invisible, presence sense, total recall, telepathy, telekinesis and ectoplasm. Equal to a 8th level psychic.

**Attacks Per Melee:** Three psychic attacks only.

**Bonuses:** +3 to save vs magic, +2 to save vs psychics, +15 to save vs horror factor, +1 to dodge.

**I.S.P.:** 30 **P.P.E.:** 8

**Note:** The haunting entity will use its own I.S.P. only when it has no choice. As a psychic vampire, a haunting entity draws on the I.S.P. of the people around it to perform its psychic feats. If there is no I.S.P. available (or used up) the creature will draw on the people's and animal's P.P.E. and convert it into usable psychic inner strength points (I.S.P.) at a rate of FOUR I.S.P. per every *one* point of potential psychic energy (P.P.E.). The ghost must draw ectoplasm from an unwitting human source. On rare occasions the spirit may draw on the powerful emotions of a living person, becoming his or her ghostly clone. These are known as **dopplegangers** and will follow its human duplicate around haunting his every movement, appearing and disappearing randomly. All the usual conditions apply.

## TECTONIC ENTITIES

One of the more powerful and dangerous entities is the tectonic entity. A wandering energy vampire that, like the syphon, craves the pain and suffering of humans. As an energy being it has only psychic abilities to rely on. Actually, that's all it really needs because, like the poltergeist, it can easily draw potential psychic energy (P.P.E.) from those around it, without hurting a soul. But this is a diabolical monster that hurts and kills for pleasure. Like its cousins, the entity can experience the emotions of others, a delightful sensation. To achieve both goals the tectonic entity invisibly stalks its intended victim(s) in a secluded place, then, at the right moment, builds itself a physical body and attacks. It is this ability to *build* a body that gives the creature its name "tectonic: pertaining to construction or building."

The "building" entity can construct its body out of any available inanimate objects and debris. This means that the body can be made of trash (rags, tin cans, plastic, milk cartons, garbage and so on), twigs and wood, skeletal remains, leaves, toys, junk, dirt and rocks, and so on. All the objects must be *small*, no couches or car fenders, and *non-living*. To build its body, the thing telekinetically pulls the objects of choice together to build a hideous humanoid mound of debris. Now with its physical body it can terrify and kill at the same time. The terror satiates its demon pleasure, the killing doubles the amount of available P.P.E. to devour and destroys a repugnant human too.

The tectonic entity can also *inhabit and animate* small humanoid or animal shaped objects, such as dolls, puppets, and statues. Size limit is four feet (1.2m) and no smaller than one foot (0.3m). The animated objects can be vacated at will but can not be reanimated for another 12 hours. **Note:** The entity can animate an object or build a body as often as once every 12 hours, not any more than that.

## TECTONIC ENTITY

**Horror Factor:** 14

**Alignment:** Miscreant or Diabolic

**Size:** As small as one foot and as big as twelve feet (.03 to 3.6m). An average energy being is about 4ft.

**Weight:** Varies greatly with the composition of the body.

**Armor Rating:** Not applicable.

**S.D.C.:** Leaves and rags — 60, twigs and wood — 170, dirt — 260, dirt and rocks — 300, plastic and tin cans — 250, miscellaneous trash (cans, glass, plastic, rags) — 250, animated stuffed doll — 50, puppet — 75, mannequin — 120, stone statue — 200.

**Hit Points:** The energy entity has  $1D6 \times 10 + 30$ .

**The Eight Attributes:** Not applicable, but very intelligent, crafty and cruel; equal to an I.Q. of 10 or 11.

**Natural Abilities:** Able to compose a physical body, roughly humanoid in shape, out of inanimate objects. Also able to inhabit and animate small objects, such as dolls and statues. The energy form is impervious to all physical and energy attacks, but is vulnerable to magic and psychics. The energy form can fly and hover at a maximum speed of 20mph (32kmph) and is invisible to the human eye.

**The physical body** that the tectonic entity constructs or inhabits is not alive, consequently, it is *impervious* to cold, poison, drugs, gases and does not require air to breath. Although it has a structural damage capacity (S.D.C.), bullets, stabbings, slashings and hitting effectively do no damage except to punch holes into the thing or dent or mangle part of it. There is no pain. The only way to stop the entity in its artificial body is by destroying it. Fire, explosives, energy weapons and magic are always effective. **A warning about fire:** Remember the thing is not alive and feels no pain. Setting it on fire will eventually destroy the body, but until the thing is completely burnt to a cinder, all you've done is make it a flaming monster that's momentarily even more deadly. It can walk around on fire, attack and fight until ALL the S.D.C. of its body are gone.

**Psychic Abilities:** Empathy, mind block, presence sense, see aura, sixth sense, levitation, telekinesis, and see the invisible. Equal to a 4th level psychic.

**Attacks Per Melee:** Three, inflicting 3D6 points of damage in a stone or metal body and 2D6 points of damage in *all* other forms.

**Bonuses:** +2 to damage in a wood body, +4 to damage in a stone or metal body, +2 to parry and dodge, +2 to save vs magic, +1 to save vs psychic attack and +10 to save vs horror factor.

**I.S.P.:** 20 **P.P.E.:** 10

**Note:** The tectonic entity will use its own I.S.P. only when it has no choice. As a psychic vampire, a tectonic entity draws on the I.S.P. of the people around it to perform its psychic feats. If there is no I.S.P. available (or used up) the creature will draw on the people's and animal's P.P.E. and convert it into usable psychic inner strength points (I.S.P.) at a rate of FOUR I.S.P. per every *one* point of potential psychic energy (P.P.E.).

## THE POSSESSING ENTITY

The possessing entity is generally considered to be the most powerful and dangerous of the entities. It is an intelligent and malevolent force that relishes human torment and anguish. Like the other entities, it is a psychic vampire that feeds on the



potential psychic energy of its victim and those around it. However, it takes particular pleasure in horrifying and bedeviling the friends and family of the possessed person. A successful possession means the entity has inhabited the body of a living creature and completely dominates that body. The essence and intellect of the original person is completely submerged, dormant, as if asleep, and will have no idea nor memory of what the possessing entity is doing with his/her body. The hideous thing can commit murder or worse, vacate the body and the innocent person will suddenly have control of his body, but has been seen by a dozen witnesses to be the killer. He will have no memory of such an atrocity. Similarly, the possessing entity can allow the person to regain his/her faculties and momentary control without leaving the body, but by releasing its domination of the host body. It can regain control instantly, and unlike the victim of the possession, is completely aware of everything that person experiences. A favorite ploy of a possessing entity is to relinquish its control long enough to convince the victim and those around him that he is insane (a psychopathy or multiple personality). It is only after the entity has pushed things too far that it will drop its charade and let those around it know of its true identity/presence. *See the section describing possession for full details.*

**Getting rid of a possessing entity** is extremely difficult. Magically, only exorcism has any chance of success. Banishment, control or summon entities and all the rest are ineffective. Of course, one can always try to talk the damned thing out, but that seldom works. Psychic powers can be used to attack the entity itself, but will definitely provoke the creature to violence. A psychic healer can also use his form of exorcism against the possessing entity. The incapacitation of the host body through drugs or magic for long durations (1D6 months) may entice the entity to leave in search of a more fun body. Killing the host body will always set the entity free, but doesn't do much good for the victim.

## POSSESSING ENTITY

**Horror Factor:** 10

**Alignment:** Any Evil

**Size:** About 4ft (1.2m) as an energy being.

**Weight:** Not applicable.

**Armor Rating:** Not applicable.

**S.D.C.:** Not applicable to energy being. Adds 10 S.D.C. to the person or animal it possesses.

**Hit Points:** The entity has  $2D6 \times 10 + 40$

**The Eight Attributes:** Not applicable to the entity in energy form, although it is extremely intelligent, cunning and treacherous, equal to an I.Q. of 17 or 18. Enjoys the physical attributes of the host body it possesses (not skills or memory).

**Natural Abilities:** In energy form: Possession of others (human or animal), empath, feels emotions of others (costs no I.S.P.). Hover and fly at a speed of 35mph (56kmph), natural state is invisible and is impervious to physical and energy attacks, including poisons and drugs. **Note:** All forms of attacks will affect the host body.

**Psychic Abilities:** Empathic transfer, bio-manipulation, levitation, telekinesis, sixth sense, see the invisible, impervious to fire, death trance, telepathy and mind block. Equal to a 6th level psychic.

**Attacks Per Melee:** Four hand to hand, doing 2D4 damage or by weapon. Two psychic attacks are possible per melee.

**Bonuses:** +6 to damage, +4 to parry, +4 to dodge, +2 on initiative, +2 to save vs magic, +2 to save vs psychic attack, +10 to save vs horror factor. All apply to physical form too.

**I.S.P.:** 30 **P.P.E.:** 20

**Note:** The possessing entity will use its own I.S.P. more readily than the other entities, but prefers to use the psychic energy of his opponents against themselves. As a psychic vampire, a possessing entity draws on the I.S.P. of the people around it to perform its psychic feats. If there is no I.S.P. available (or used up) the creature will draw on the people's and animal's P.P.E. and convert it into usable psychic inner strength points (I.S.P.) at a rate of FOUR I.S.P. per every *one* point of potential psychic energy (P.P.E.).

## GARKAIN

### The Dumb Spirit

The garkain is a huge, hideous bat-thing known in aborigine legend as a flesh eating demon. It is possible that the garkain's appearances elsewhere in the world have been confused with the classic vampire.

The garkain, known as the dumb spirit because it is a mindless animal predator, resembles a monstrous human with massive leather wings. Its head is human-like with deep set red eyes and gaping mouth full of pointed teeth and fangs. Its humanish hands and feet lend to the illusion that the creature is half man, half bat.

A voracious carnivore, the garkain will swoop down on its victim, wrap him in its powerful wings embrace and smother him or tear out the throat with its teeth (again the similarity to the vampire). The beast then tears its victim limb from limb and devours it. The creature is "dumb" in that it knows no fear and will fight against a vastly greater number of opponents. It will suffer massive damage before it will fly away to rest and heal. In Australia it is also known to snatch children in mid-flight carrying them to its lair to be devoured.

## The Garkain

**Horror Factor:** 14

**Alignment:** Diabolic or Miscreant

**Size:** Stand man-sized about 6ft (1.8m), wing span of about 10ft (3m).

**Weight:** 300lbs (136kg)

**Armor Rating:** 10, tough, leathery skin.

**S.D.C.:**  $1D4 \times 10$  **Hit Points:**  $1D6 \times 10 + 20$

**The Eight Attributes:** The number of six-sided dice are indicated as follows: I.Q. 1, M.E. 5, M.A. 1, \*P.S. 4, P.P. 4, P.E. 4, P.B. 1, \*\*Spd. 2

\*Physical Strength is always a minimum of 18.

\*\*Speed flying is 40mph.

**Natural Abilities:** Fly, superior night and day vision, like an owl. Can see a one foot tall target two miles (3.2km) away, impervious to poisons, toxins, drugs, and gases. Bioregenerates at a rate of 6 S.D.C. and 2 hit points per hour.

**Psychic Abilities:** None

**Attacks Per Melee:** Four, inflicts 2D6 damage by hands plus P.S. bonus, 2D6 damage by bite (no P.S. bonus). Never uses a weapon.





**Bonuses:** In addition to attribute bonuses the creature is +2 to dodge in flight, +2 on initiative, +4 to save vs mind control, psychic or magic, +10 to save vs horror factor.

**I.S.P.:** None **P.P.E.:** 1D6

**Note:** The garkain is a nocturnal predator and rarely ventures forth during the daylight hours. If cornered with no way out it will always fight to the death. Its bizarre physiology completely dissolves into a protoplasmic goo within minutes, bones and all.

## GARGOYLES

Gargoyles are huge demonic creatures who appear as lizard-like humanoids, with massive bat wings, sharp-toothed maw and glowing yellow eyes. The specter of their grim visage can be seen in legends throughout the world. Gargoyles are pack creatures that travel in vast hordes in their own dimension. Fortunately, one seldom encounters more than a pair or two in our world.

Gargoyles are *not* especially intelligent creatures, relying on brute strength and superior numbers rather than cunning. However, they are not stupid, can be quite treacherous and are always ruthless. One of the great dangers that gargoyles represent is that they are instinctively aggressive predators who work as part of the pack or tribe. They love to fight and will die with a toothy grin stretched across their lips. Part of the pack mentality is to secure a territory, mate and expand. This could be devastating to Earth if a large group of gargoyles ever established a foothold in our dimension.

Gurgoyles are somewhat smaller, wingless versions of gargoyles. They are equally as vicious as their winged brothers

and serve as the foot soldiers of the marauding horde. Both gargoyles and gurgoyles are carnivores who will feast on the flesh of any living creature who falls prey to them, from cattle to humans.

Although gargoyles and gurgoyles possess some psychic abilities, it is only the gargoyle lords who possess magic knowledge. A gargoyle lord will be one of the few creatures (one in a hundred) who have an unusually high amount of potential psychic energy and can wield magic. Fortunately, their range of mystic knowledge is usually very limited.

## Gargoyle and Gargoyle

**Horror Factor:** 16 (14 — gurgoyles)

**Alignment:** Anarchist or any evil.

**Size:** Gargoyle — 10 to 20ft tall (3 to 6.1m), wing span is 20ft across (6.1m). Gurgoyles — 8 to 12ft tall (2.4 to 3.6m).

**Weight:** 1000 to 2000lbs (one ton).

**Armor Rating:** 10; tough skin.

**S.D.C.:** Gargoyle — 1D4 × 100

Gurgoyles — 1D6 × 20

**Hit Points:** Gargoyle — 3D4 × 10

Gurgoyles — 2D4 × 10

**The Eight Attributes:** The number of six-sided dice are indicated as follows: I.Q. 2, M.E. 3, M.A. 2, \*P.S. 5, P.P. 5, P.E. 5, P.B. 2, \*\*Spd. 5

\*Minimum possible strength (P.S.) is 20.

\*\*Speed flying is 50mph (80kmph).

**Natural Abilities:** Gargoyles can fly, both gargoyles and gurgoyles have superior night and day vision, like a hawk, and are able to see a foot tall (0.3m) target 2 miles (3.2m) away.



**Psychic Abilities:** Meditation, mind block, presence sense, sense magic, telepathy, resist hunger, resist fatigue and resist thirst. Equal to a 6th level psychic.

**Attacks Per Melee:** Both creatures have three attacks per melee. Claws inflict 3D6 damage plus P.S. bonus, bite does 2D6 (no P.S. damage bonus). A flying tackle does 4D6 to damage, but counts as two attacks. Magic used by the gargoyle lords has the usual restrictions.

**Bonuses:** In addition to physical attributes, +2 on initiative, +2 to dodge while in flight, +1 to save vs psychic attacks, and +10 to save vs horror factor.

**I.S.P.:** 1D4 × 10

**P.P.E.:** 2D6 for typical gargoyles and gurgoyles.  
2D4 × 10 for gargoyle lords.

**Note:** Female gargoyles and gurgoyles lay 4D6 eggs once every 10 months. The eggs hatch within three months. Young reach full maturity within two years (play young as having half the usual stats). If a nest is invaded, the gurgoyles will fight to the death, defending the gargoyle eggs even if it means sacrificing their own. Gurgoyles are always submissive and loyal to gargoyles.

**Magic knowledge for the gargoyle lords** is limited to 1D4 spells from each of the first four levels of magic (1-4) and equal to 1D4 levels of experience.





# GRAVE GHOULS

## The Classic Ghoul

Stories of ghouls, grave robbing demons who eat the flesh of the dead, exist in the legends of all people. They are ugly, human-size creatures who resemble walking, skeletal corpses. Grave ghouls are frequently found in large, old cemeteries near ley lines. Why they seldom stray far from a ley line is not known. Unlike the other ghoul scavengers, grave ghouls are a cowardly, seclusive lot who simply wish to be left alone to dine on the bones of the dead. When discovered, they will hiss and growl menacingly. If that does not seem to frighten away the person(s) they will try to escape, fleeing into shadows and burrowing into graves. Grave ghouls will fight only when cornered without an avenue of escape, or if they outnumber the living by at least three to one. A single ghoul might attack a baby or a child under the age of fourteen, but would do so only in spite or anger. They hate fresh flesh, so they will never mutilate a fresh kill or any corpse less than a few months old.

Grave ghouls always travel in groups of two to eight, but even with four pairs they are shameless cowards. However, if a person(s) shows genuine terror and flees screaming, the ghouls will give chase, hooting and howling just for the sheer, malicious fun of it. Even then they will rarely make a concerted effort to actually catch the person(s) for fear that he/she/they might fight back. Don't be fooled. A cornered grave ghoul will fight with the ferocity of a tiger.

The grave ghoul is impervious to cold, needs no air to breathe, impervious to poisons, drugs and gases. Physical attacks, including bullets, do half damage. Fire does double damage and magical attacks have full effect. Exorcisms, banishment, constrain beings, and summon lesser beings, are all excellent means of controlling or discharging the cowardly fiends. **Note:** A dead ghoul will look exactly like an exhumed human corpse and will not prove that it was a supernatural monster.

## Grave Ghoul

**Horror Factor:** 12

**Alignment:** Anarchist, Miscreant or Diabolic.

**Size:** Human about 6ft (1.8m).

**Weight:** About 125lbs (56kg).

**Armor Rating:** None

**S.D.C.:** 1D4 × 10 **Hit Points:** 1D6 × 10

**The Eight Attributes:** The number of six-sided dice are indicated as follows: I.Q. 2, M.E. 1, M.A. 1, \*P.S. 4, P.P. 3, P.E. 2, P.B. 1, Spd. 4

\*The physical strength (P.S.) is never less than 16.

**Natural Abilities:** Nocturnal creatures with nightvision (200ft/61m range), blinded by daylight or bright artificial light (-8 to strike, parry, dodge). Impervious to cold, poison and gases. Physical attacks do half damage, fire does double damage. Can dig into dirt and clay at a rate of ten feet (3m) per minute. Do not require air to breathe, so they sleep underground, in the dirt, during the day and often access coffins from underground. They are compelled to walk on the surface during the nights of a full moon. Also prowl at a 68% skill proficiency and have the innate magic ability to shadow meld (equal to a 10th level spell).

**Attacks Per Melee:** Three; hands/claws do 2D4 damage plus P.S. bonus, bite inflicts 1D6 damage.

**Bonuses:** +2 to dodge.

**I.S.P.:** None **P.P.E.:** 1D6

**Note:** Ghouls can not speak, but understand all languages.

# GREMLINS

## Techno-Terrors

Gremlins are ugly, slobbering, little humanoid creatures with a cruel streak a mile long. A typical gremlin stands about two feet tall (0.6m), with a potbelly, hairy legs and arms, pointed ears, slanted, red eyes and an oversized, sneering mouth with jagged little teeth. They are fairly weak in hand to hand combat and will always flee when confronted with an opponent(s) who is more powerful or dangerous than they.

The gremlin has only three significant powers: electrokinesis, levitation and object read. They also have an uncanny, natural mechanical aptitude. A potentially deadly combination of abilities for the crafty and devious gremlin.

The miniature demons use their powers and abilities to *sabotage* electrical and mechanical devices to cause trouble, destruction and death. They are cruel pranksters who delight in the suffering of humans. They think it is great fun to short-circuit electrical wires, start fires, deactivate warning systems, tamper with a car's brakes, turn off power, knockout electrical service and so on. Of course, timing is everything if one wants a truly excellent disaster.

A gremlin will cause trouble and mayhem at the same location as long as it feels it won't get caught and there's enough mischief to amuse it.

## Gremlins

**Horror Factor:** 10

**Alignment:** Diabolic or Miscreant.

**Size:** 2ft (0.6m)

**Weight:** 20lbs (9.1kg)

**Armor Rating:** None

**S.D.C.:** 1D4 × 10 **Hit Points:** 4D6

**The Eight Attributes:** The number of six-sided dice are indicated as follows: I.Q. 3, M.E. 3, M.A. 2, P.S. 1, P.P. 3, P.E. 1, P.B. 2, Spd. 2

**Natural Abilities:** *Uncanny mechanical aptitude* which enables it to understand, operate and tinker with machines; 50% skill proficiency. *Specific skills include:* Operate computer — 60%, repair (sabotage) computer — 32%, automobile mechanics — 60%, pilot any vehicle — 45%, read sensory equipment — 50%, basic electronics — 50% and pick locks — 70%.

**Other Abilities Include:** Prowl — 50%, impervious to toxins, poisons, drugs, gases; does not need air to breathe, and is impervious to electricity.

**Psychic Abilities:** Levitation, object read and electrokinesis. All are performed at 4th level proficiency.

**Attacks Per Melee:** Two hand to hand, doing 2D4 damage, or bite, doing 1D4 damage. Three psychic attacks per melee.

**Bonuses:** +2 to dodge, +6 to save vs horror factor.

**I.S.P.:** 60 **P.P.E.:** 2D6

**Note:** The gremlin's body shrivels up and turns to ash when it is killed.



## HELL HOUNDS

Myth is rife with tales of supernatural monster dogs. These hell hounds or Devil Dogs are weird, shape-changing creatures who try to assume the form of a wild dog. However, like the boschala, they do not fully understand the physiology of Earth creatures and often assume a twisted and grotesque appearance which can only be described as a monstrous resemblance to dogs (see back cover).

England has a history of spectral dog packs, the most famous of these is probably the Headless Hounds of Dartmoor. The most dangerous is said to be the Devil's Dandy Dogs that roam about Cornwall. Australia is also plagued by these monstrous dogs and, to a lesser degree, the plains of Africa and the North American wilderness. A number of disturbing reports suggest a pack of hell hounds may be roaming the sewers and slums of New York City.

Hell hounds always run in packs of four or more (roll 4D4 dice) and hunt only at night. At the first light of day the hideous mockeries of nature fade away, giving credence to the belief that they are ghostly apparitions. In reality, sunlight transforms the weird beasts into invisible energy beings (their natural form). As energy beings they have no powers to use against humans. But at night they can assume physical shape and stalk human prey. The hell hounds are natural predators with animal intelligence and instincts. The demon dogs attack humans simply because they are easy prey. What makes them doubly lethal is that hell hounds are territorial, hyperactive, irritable and aggressive in the extreme.

### Hell Hounds

**Horror Factor:** 16

**Alignment:** Miscreant or aberrant.

**Size:** About the size of a large dog, like a German Shepard, coyote or wolf.

**Weight:** About 50lbs (22kg).

**Armor Rating:** None

**S.D.C.:** 1D4 × 10 **Hit Points:** 6D6

**The Eight Attributes:** Not applicable; animal I.Q. about equal to a dog's.

**Natural Abilities:** Running speed about 20mph (32kmph) and never seems to tire. Track by smell — 71%, keen nightvision — 400ft (122m). Vulnerable to all types of attacks.

**Attacks Per Melee:** Three; bite inflicts 2D6 damage, claws do 1D6 damage.

**Bonuses:** +2 to strike, +2 to dodge, +10 to save vs horror factor.

**I.S.P.:** None **P.P.E.:** 2D6

**Note:** Always hunt in a pack of 4D4. Reverts to energy form and fades to nothing when killed. Although fire will hurt the creatures they are not afraid of it.

## MALIGNOUS

Another energy being that can assume a physical form in our world is the horrid insect thing known as malignant. A frightful creature that resembles a monstrous, deformed scorpion. To anchor itself to our world, the invisible energy being possesses an insect. Within a few hours, (1D6) it transforms the tiny, harmless bug into a gruesome giant the size of a horse, Its tail

is a wicked, lightning fast stinger that secretes a paralyzing toxin. The mouth is a grisly appendage with a three foot long tongue. Around the mouth-trunk are 20 eyestalks that make impossible to catch the hellish thing unawares.

The malignant is a predator that will feed on man or animal without preference. Its sole purpose is to satiate its appetite for delectable, fresh, bone marrow. It can function equally well during both day and night, but finds the night to be more advantageous. When not on the prowl, the creature will spin a nest in a deserted building, dead-end alley, basement, sewer or cave. Like all insects, the malignant can scale walls and ceilings with incredible speed and agility. This ability gives the thing outstanding mobility in cities, where it can climb buildings and hide in shadows, on roofs, under water towers or ceilings, moving high and low, darting around corners and ducking under cover. Add to this that it prowls among the populace, assaults on the creature must be carefully planned so as to not endanger innocent bystanders or greatly damage property. Although the malignant has an animal-like intelligence, it is an exceptionally clever predator, using hit and run tactics and never standing its ground against multiple opponents unless trapped. When pursued it will hide in the most inaccessible places and be very difficult to reach without placing oneself in its striking range. This hunter can be unbelievably elusive despite its immense size. Fortunately, it kills only to feed, about once every two or three days.

### Malignous

**Horror Factor:** 16

**Alignment:** Considered evil.

**Size:** About 6ft tall (1.8m) and 12ft long (3.6m).

**Weight:** 800lbs (363kg).

**Armor Rating:** 14

**S.D.C.:** 4D4 × 10 for the insect body.

**Hit Points:** 1D6 — insect body; the energy being possessing it has 1D4 × 10 hit points.

**The Eight Attributes:** Not applicable; animal I.Q., but tricky and elusive.

**Natural Abilities in Insect Form:** Climb on all surfaces straight up and down, upside down, or on the ground, with a mind boggling speed of 22 (15mph/24kmph). Leap up to 20ft (6.1m) up or across. Superior vision, with multiple eyes enabling it to see in *all* directions at once; it can not be surprised. Nightvision — 600ft (183m), prowl — 83%. Resistant to toxins (half damage). In energy form the malignant is invisible, can hover and fly at a speed of 35mph (56kmph), is impervious to toxins and physical attacks. *Vulnerable* to energy, magic and psychic attacks. **Note:** When its insect host body is destroyed, the energy being is released. The shock is likely to send it reeling back to its own dimension (64% likelihood). If it manages to remain in our world, it will find a new insect host body and begin its hunt again within 48 hours. An exorcism can also send it out of the host body (turning back into a normal cockroach) and back into its own dimension. Banishment or constrain being will only hold the malignant in giant bug form at bay or chase it away.

**Attacks Per Melee:** Three; stinger does 1D6 damage plus the victim must roll to save vs poisons/toxins (14 or higher) each time the character is stung. A failed roll means the victim is paralyzed. Paralysis begins after one melee (15 seconds).



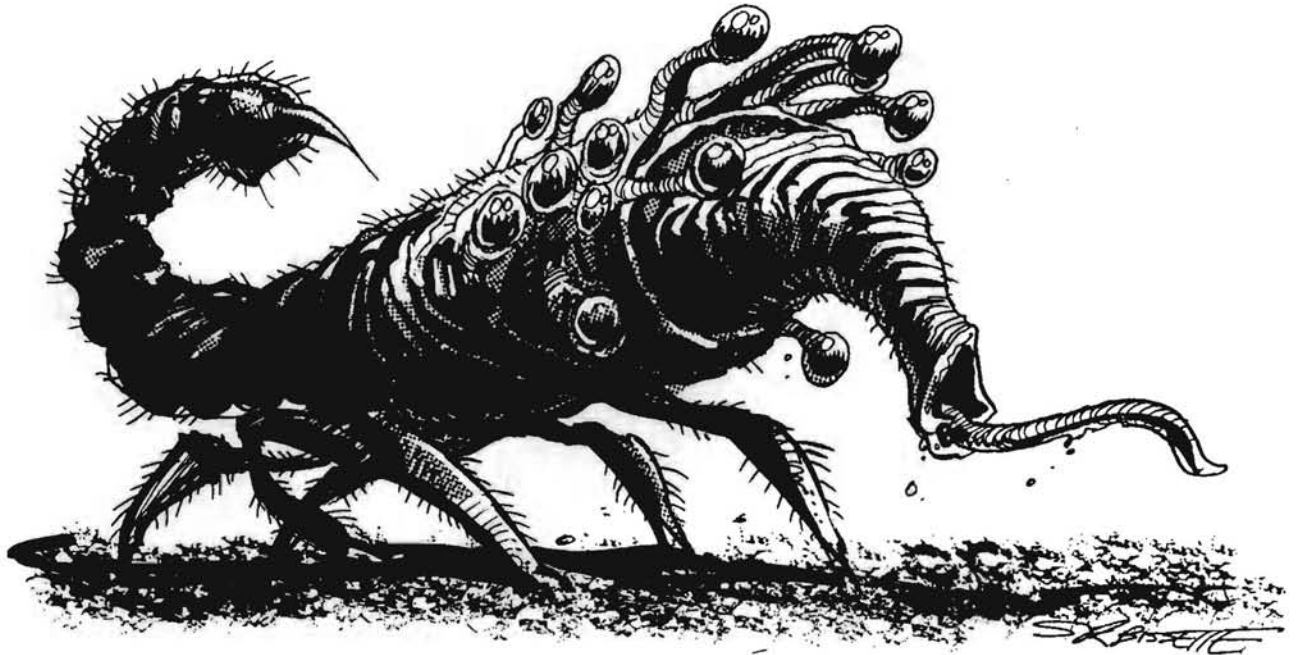

First the arms will go limp and the person will feel dizzy. Within another 4 melees (one minute) the legs go numb and the person is helpless. If the character can be rescued the paralysis is temporary, lasting about 4D4 minutes. **Other attacks** can be made by the legs, doing 1D6 damage, and by the mouth-trunk which has tiny little teeth inside for cracking bones; 1D4 damage.

**Bonuses:** +2 to strike, +3 to dodge (automatic, like a parry, and does *not* forfeit an attack), +2 to save vs poison, +10 to save vs horror factor and can not be possessed.

**I.S.P.:** None **P.P.E.:** 3D6

**Note:** A solitary creature, it never associates with its own kind or other supernatural creatures, unless controlled by an arcanist or greater being.

## NACARANT The Scarlet Hunter

The nacarant is a horrible creature that absorbs its victims. The thing starts off as a mass of amorphous tissue. The scarlet red, pulsating blob waits patiently for an animal to come too near or for a human to make the mistake of touching it. One touch will find the hand completely engulfed and the hideous protoplasm quickly climbing up the arm. The only hope for survival is to cut the arm off. An entire human body will be engulfed in about a half hour. This first victim dies the most horrible death. Eight to twelve hours after the first victim has been completely covered, the nacarant assumes its shape, seemingly bringing the scarlet, slime covered corpse to life. In actuality, the creature has used its victim's potential psychic energy and protein to transform itself into a body more indigenous to that world. This is how the nacarant adapts to its environment.

Mobile and hungry, the nacarant goes on a killing spree. From this point on, the monster will kill with tooth and claw. At the moment of death the fiend absorbs and stores the doubled P.P.E. of the victim, human or animal. It then shoves the victim into its body. Each time it absorbs another victim, another section of the body surface grows a head representing the victim's distorted face. Each head, whether it be human or animal, will have eyes that move, gnashing teeth and can howl, growl and grunt as a living extension of the creature. The nacarant will continue its mad killing onslaught, absorbing P.P.E. and bodies for five days. At the end of that period, the gruesome beast will explode and dissolve into scarlet goo. But this may not be the end of the ghoulish thing. The nacarant can reproduce itself every five day cycle by absorbing and storing enough potential psychic energy; a total of 180 P.P.E. The cycle always begins as the blob of pulsating scarlet tissue.

### Nacarant

**Horror Factor:** 17

**Alignment:** Diabolic

**Size:** Varies, from man-sized to up to 18ft (5.4m).

**Weight:** Varies from about 100lbs to 600lbs (45 to 272kg).

**Armor Rating:** None

**S.D.C.:** 1D6 × 10 **Hit Points:** 1D6 × 10 plus 10 per each victim absorbed..

**The Eight Attributes:** Not really applicable; wild, insane, animal-like intelligence driven to kill. Speed: 22 (15mph/24kmph).

**Natural Abilities:** Impervious to physical attacks and poisons, but vulnerable to fire (does double damage), energy, psychic and magic attacks; fears fire. Bio-regenerates at a rate of 4D6 S.D.C. and 4D6 hit points per hour. Climb — 50%, prowl — 36%, track by smell — 40%. Possesses no psychic or magic powers.





Nacarant



**Attacks Per Melee:** Three, plus one for every two creatures it absorbs. Claws do 2D6 damage plus 1D6 per every four creatures absorbed, bite does 2D4.

**Bonuses:** +2 to damage, +2 to strike, +3 to parry and dodge, +10 to save vs horror factor. Can not be possessed.

**I.S.P.:** None **P.P.E.:** One to start with. Needs 180 to be born again at the end of five days.

**Note:** Exorcism is ineffective against the nacarant, but constrain being and banishment work great. If the nacarant fails to accumulate 180 P.P.E. it dies.

## SOWKI The Serpent

The sowki's (pronounced sah-woo-key) visage is right out of classic, ancient demon myths. A tall, powerfully built man who, from a distance, might look human. But close up, it is immediately apparent that this creature is not of our Earth. Its skin is like that of a snake, but it is the monstrous three eyed head, and jutting, five inch fangs that reveal its true alien origin.

An intelligent being, a sowki is generally not driven by blood lust to destroy or devour the human race (although human flesh is considered delicious). Instead, they see Earth as a land of opportunity. A place where they wield great power and wealth, for the sowki are demonic beings who would be men. Or more to the point, "rulers of men." To this purpose they establish lairs among humans, and walk among them with illusion and metamorphosis. They use their dark secrets of magic to build a fortune and purchase an army of ruthless humans who will not ask questions and who will serve any master, so long as they share in the reward. More than a few times, a sowki has formed a cult with himself as the leader arcanist, or even revealed bits of his true form and was worshipped as the devil or an ancient god or savior.

A sowki has no limit to its arrogance and that is usually its downfall. In almost every known case, the snake man will not stop in its quest for power. A compulsive megalomaniac, the fiend always goes too far, dares to conquer too much, spreading itself out too thin or daring to take too many foolish risks. The reptilian's power lays in its cunning and mystic knowledge. Although physically powerful, it is not strong enough to withstand the onslaught of brave humans trying to save themselves from its loosening grip of terror. The cunning goqua find that this blind arrogance makes the sowki a wonderful pawn in their larger games.

### The Sowki

**Horror Factor:** 14

**Alignment:** Anarchist or any evil.

**Size:** 6ft 6in to 7ft (1.9m to 2.1m).

**Weight:** About 300lbs (136kg).

**Armor Rating:** None

**S.D.C.:** 1D6 x 10 **Hit Points:** 2D6 x 10.

**The Eight Attributes:** The number of six-sided dice are indicated as follows: \*I.Q. 4, M.E. 4, M.A. 4, P.S. 4, P.P. 3, P.E. 3, P.B. 2, Spd. 3

\*I.Q. is never lower than 14.

**Natural Abilities:** Superior vision like a hawk, able to see a one foot target up to 2 miles (24km) away; nightvision — 600ft, and the top, third eye can see the invisible. Hates the

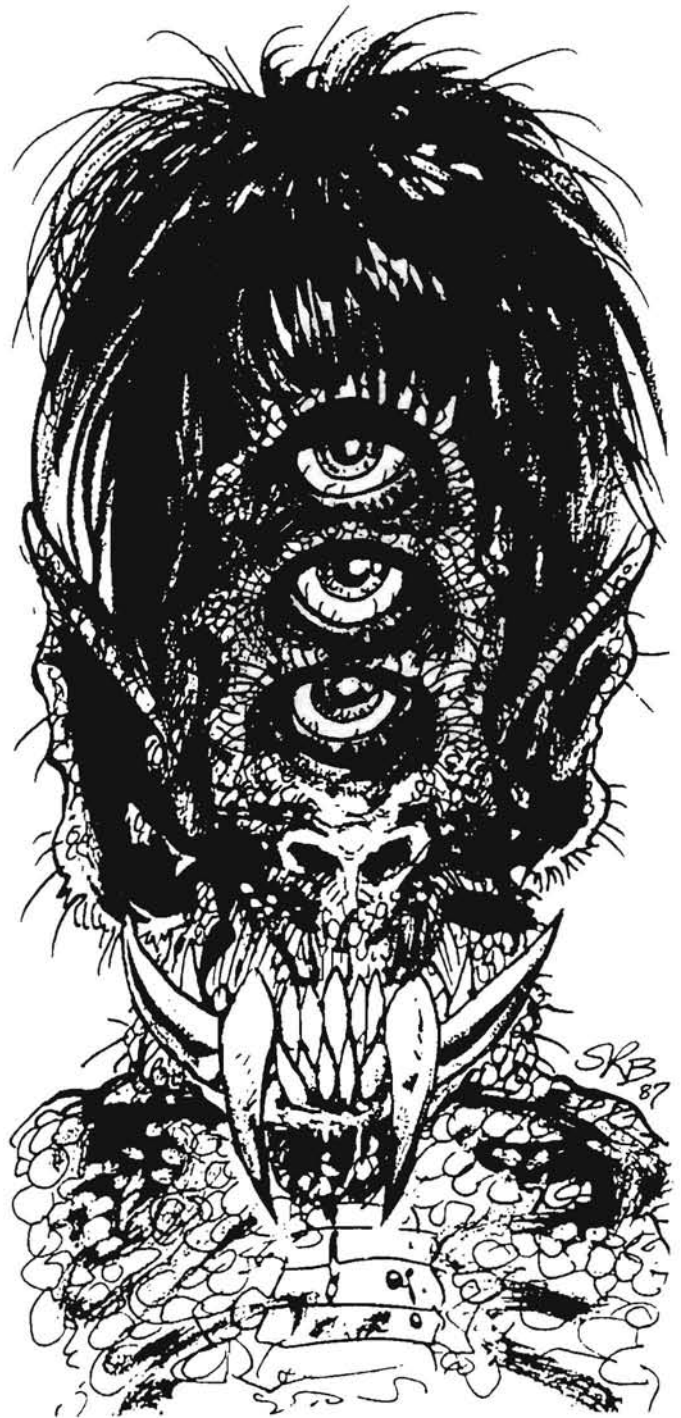

cold, but functions well in extreme heat; fire resistant (does half damage). Understands and speaks all languages.

**Psychic Abilities:** Meditation, mind block, sense magic, speed reading, suggestion, summon inner strength and total recall. Equal to a 3rd level psychic.

**Magic Abilities:** Knows all *illusionary* spell and ritual magic, including death trance, concealment, detect concealment, charismatic aura, multiple images, horrific illusion, apparition, mask of deceit, and hallucination. It also knows metamorphosis: animal, metamorphosis: human and summon lesser beings. May (50% chance) know an additional 2D6 spells from levels 1 through 3. *Level of Experience (arcanist) is 1D4 + 2.*

**Attacks Per Melee:** Three hand to hand; fists inflict 2D4 plus any P.S. bonus, bite does 2D4 plus a poisonous toxin that does another 2D6 damage unless the character rolls a success-



ful save vs poisons (14 or higher). Roll for each bite. Magic has its usual limitations.

**Bonuses:** +1 on initiative, +2 to parry, +2 to dodge, +3 to strike, +3 to save vs magic, +2 to save vs psychic attack, +8 to save vs horror factor.

**I.S.P.:** 6D6 **P.P.E.:** 1D6×10+10.

## SPIDER DEMONS

### The Death Weavers

Most humans seem to have an aversion to spiders. Is it a simple matter of being repulsed by their ugly appearance or is it a stirring of a racial memory? A memory of a time when man often struggled against gigantic, hellish spider-things?

There is a demon the Cunto Indians of South America call the "Death Weaver." A vile supernatural creature that appears as a giant spider with a hideous, half human head and a death's skull emblazoned on its hind quarters. *The Indian legend says that the Death Weavers were overlooked by the gods as lowly predators of vermin. The spider demons were much more intelligent than any suspected and stole the gods' secrets of magic, throwing them to the wind, scattering magic across the world where mortal man could learn its secrets. For eons the spiders have searched the globe, retrieving the magic and mastering its secrets for themselves, so that they might become gods.*

The old indian legend has a ring of truth, as legends often do. The so-called spider demons are other-dimensional visitors that have found Earth to be a hospitable environment for them, preferring hot, steamy jungles over cooler climes. For this reason they seem to be found only in South America, Africa, India, Asia, Malaysia, parts of China and similar tropical retreats which have not been completely claimed by man. As the legend infers the creatures do understand and practice magic. Indeed, they hoard magic knowledge, books, artifacts and paraphernalia. The spiders will stop at nothing to obtain magic and will fight to the death to keep it.

The Death Weavers see humans as three things: food, pawns and a source of potential psychic energy. Over the centuries, they have often manipulated primitive people to worship them as gods (or demons) or have established secret death cults. The spiders are cunning, ruthless and more than a little insane.

## Spider Demons

**Horror Factor:** 16

**Alignment:** Diabolic or miscreant (occasionally aberrant).

**Size:** Stand 6 to 8ft tall (1.8m to 2.4m) and 6 to 8ft long.

**Weight:** 600 to 1000lbs (272 to 453kg).

**Armor Rating:** 7

**S.D.C.:** 1D4×10+10 **Hit Points:** 1D6×10+20.

**The Eight Attributes:** Not applicable; but very devious and cunning; I.Q. about equal to 13 or 14.

**Natural Abilities:** Can climb on most surfaces with amazing speed (15mph/24kmph), upside down, straight up, and so on, like a real spider. Only smooth, glassy surfaces impede its movement. Nightvision — 200ft (61m), prowl — 88%, and can spin a web for climbing at a rate of 200ft (61m) per melee (15 seconds). The web is fairly tough, like light rope, but deteriorates quickly (within 4 minutes/16 melees) unless a bonding resin is secreted from the spider's mouth over the web.

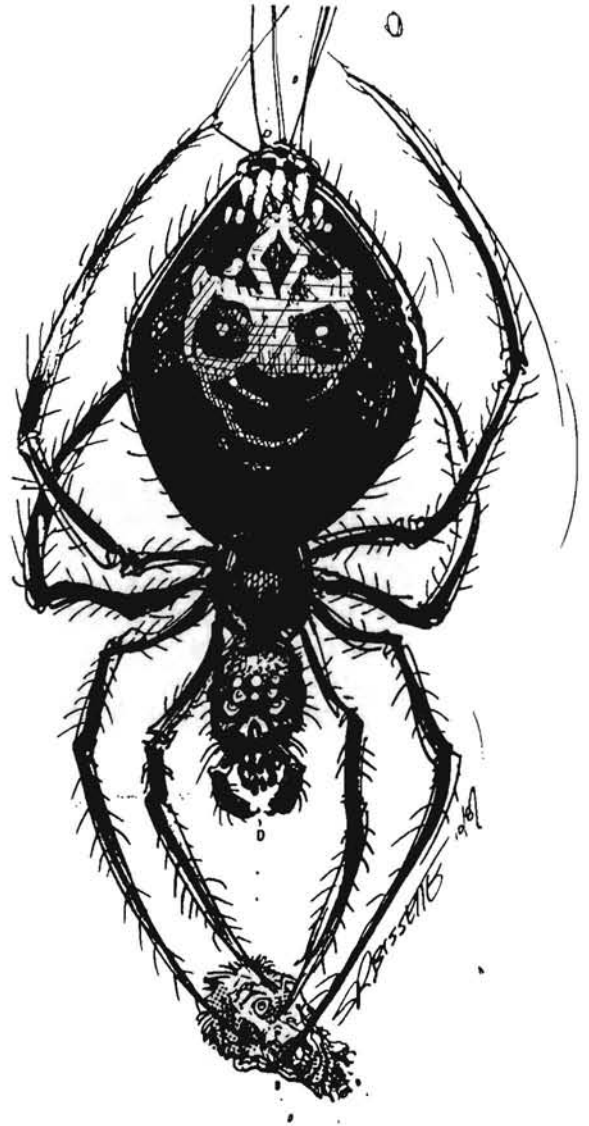

**Psychic Abilities:** Presence sense, total recall and suggestion. Equal to a second level psychic.

**Magic Abilities:** Knows 6D6 rituals selected from levels 1-8, 3D6 spells from levels 1-8 (prefers rituals), one ritual from each levels 9, 10, 11, 12 and 13 (probably summoning, protection or creation invocations), and 1D6 spells to be selected from levels 9-12. Game masters may adjust this knowledge if it's beneficial to the game. The usual magic limitations apply. Treat this character as a monstrous arcanist. *Level of experience (arcanist) — 1D6+2.*

**Attacks Per Melee:** Three physical; mandible bite inflicts 3D6 damage, hit by leg does 1D6+2.

**Bonuses:** +4 to parry, +2 to strike, +2 to save vs magic, +3 to save vs psychic attack, +10 to save vs horror factor. Vulnerable to all types of attacks.

**I.S.P.:** 4D6 **P.P.E.:** 1D4×10+10.



# TOKOLOSH

## The Sea Serpent

Tokolosh is the South African tribes' name for a mischievous water spirit. The creature appears to have human features, but the head is mounted on a long, serpentine neck, and the hands at the end of long tentacles (with a reach of 20ft/6.m). The body too, is long and serpentine, measuring up to 80ft (24.4m). Generally, the odd thing is fairly passive and peaceful, feeding on marine animals. However, sometimes the creature gets curious about a passing boat or low flying aircraft and pops up to get a closer look. Having no perception of human life, it may unintentionally kill a sailor or swimmer, grabbing him and pulling the poor soul underwater for a closer examination. It may also make grabs at small planes or helicopters and boats. It means no harm, but is too stupid a beast to know better.

Easily provoked if hurt, the tokolosh will lash out viciously, throwing sailors from the deck, tearing sails, entangling vessels, and capsizing small boats. However, it will rarely fight to the death, taking refuge underwater.

## Tokolosh

**Horror Factor:** 12

**Alignment:** Unprincipled, anarchist and occasionally aberrant or one of the other evils.

**Size:** 50 to 100ft long (15.2 to 30.5m).

**Weight:** 2 to 8 tons.

**Armor Rating:** None

**S.D.C.:** 2D6 × 100 **Hit Points:** 2D4 × 10.

**The Eight Attributes:** Not applicable; low intelligence equal to a child of 6 or 7 (I.Q. of about 4 or 5).

**Natural Abilities:** Breathe underwater (gills) and above water for up to two hours. Swimming speed — 45mph maximum depth — two miles (32km).

**Attacks Per Melee:** Four; tentacle hands do 2D4 damage from a hit, entanglement will hold its victim or crush does 1D6 damage per melee (15 seconds). Bite does 1D6 damage.

**Bonuses:** +3 to strike, +3 to parry, +3 to damage, +6 to dodge, +8 to dodge underwater; +1 to save vs magic or psychic attacks.

**I.S.P.:** None **P.P.E.:** 4D6

**Note:** It is possible that the Loch Ness Monster, Cadborosaurus in Vancouver, and sea serpents throughout the ages are Tokoloshs.



*M. O'Connor & S. R. Bissette*



## UFONAUTS

### The Flying Saucer Creature

Flying saucers or U.F.O.s (Unidentified Flying Objects) have puzzled humankind for generations. Whether they are alien visitors from the stars or other dimensions, we may never know. But one supernatural creature is responsible for at least some of the thousands of U.F.O.s reported yearly. Perhaps a lot of those sightings.

The UFOntaut is a strange, giant energy being that can be as small as a car or as big as a house. It invariably appears as the classic glowing disc, usually white with tiny, blinking pulses of blue, red, yellow and/or orange energy, which resemble landing lights on an airplane or might look like window ports. The unusual creatures can hover motionless in midair, take-off at a mind boggling Mach 5 (3350mph), make 90 degree turns and stop dead in a heartbeat.

UFOntauts are gentle, playful beings who are intensely curious about other life-forms. They will buzz airplanes and play tag with fighter jets just to see who and what these other creatures are. Although UFOntauts have been known to put on shows of aerial acrobatics to entertain a crowd of humans, they are far too shy to actually stop and say hello. Consequently, after a few minutes of play they zoom off into the sky or plunge into the ocean's depths (they love flying and swimming).

Once in a while, the timid energy beings will summon up enough courage to make a close encounter of the third kind, contact with human beings. Contact will always take place at some deserted area to avoid trouble. The massive, glowing disc-thing is probably more nervous and frightened than the humans it longs to understand. It is here, with actual contact, that the *illusion* of space aliens is made complete. The UFOntaut is a powerful psychic. In an attempt to make contact simple and *pleasurable*, it telepathically scans the person's mind and empathically feels the emotions. Thanks to popular fiction and the films of directors like Steven Spielberg, the sight of a flying saucer immediately brings to mind images of tiny, cherub-like aliens with big round eyes and oversize skills. The UFOntaut reads these images and emotions and misinterprets that this is what the person(s) wishes to experience. As an act of gratitude and kindness, the energy being implants a powerful *hypnotic suggestion* in the person's mind of what it thinks that person wishes to experience. Thus, if the person expects a friendly tour of "the" spaceship, or a romp through space, that's exactly the memory that will be implanted. If the person expects to be kid napped for examination, that's what he'll believe happened. The creature's exceptional *empathic and telepathic* abilities are used to create a vivid, but false, experience. The UFOntaut may even form a physical alien out of *ectoplasm* (also used to create probing tentacles and hands). Its *electrokinesis* ability is used to stop a car or knockout lights and to affect machines. The energy being uses a powerful form of *telekinesis* to move and carry objects up to it. Ironically, its use of telekinesis appears as a beam (wide or narrow) of white or violet light, usually misinterpreted as a tractor beam. The beam is often powerful enough to lift a car into the air.

UFOntauts are generally friendly or indifferent to humans, even when they are attacked by them. Hostility, easily avoided, is but one of the puzzles regarding humans. A UFOntaut will not get mad, it will just go away a little bit confused, but with no hard feelings. Sometimes, a particularly friendly and pleasant contact will create a bond between the psychic energy being and the human. In such cases, the UFOntaut may occasionally receive clairvoyant flashes of danger for its human buddy and return to warn him/her or help if possible. Although these psychic unions are rare, when they do occur they will last for years or even decades. **GM Note:** The UFOntaut will not follow the human around like a puppydog, but will send telepathic and empathic warnings, and help in small ways, using its psi-powers in subtle ways. It will not fight toe to toe with any supernatural creatures, or humans for that matter.

### UFOntaut

**Horror Factor:** 9

**Alignment:** Scrupulous, unprincipled or anarchist.

**Size:** 12 to 60ft (3.6 to 18.3m).

**Weight:** Unknown

**Armor Rating:** None

**S.D.C.:** None **Hit Points:** 2D4 × 100.

**The Eight Attributes:** Not applicable; I.Q. is equal to about 7 or 8, very intuitive.

**Natural Abilities:** Hover and fly at a speed of Mach 5 (3350mph), capable of almost instantaneous stops and starts and impossible sharp turns. Impervious to cold, heat, poisons and most physical attacks. Energy, explosives, magic and psychic powers have full effect. Does not need air to breathe and can withstand ocean depths of 5 miles (8km).

**Psychic Abilities:** Telepathy, empathy, suggestion (hypnosis), ectoplasm, electrokinesis, and telekinesis are all FIVE times more powerful than the human abilities at 15th level of experience. Also possesses empathic transmission, mind block, see aura, and clairvoyance roughly equal to a 15th level psychic.

**Attacks Per Melee:** Four via psychic abilities.

**Bonuses:** +8 on initiative, +10 to dodge, +6 to save vs psychic attacks, +1 to save vs magic.

**I.S.P.:** 1D4 × 1000 **P.P.E.:** 1D4 × 10.

**Note:** UFOntauts commonly enter into our world through dimensional rifts at places of power. They take refuge, living and playing, on mountain tops, great altitudes, and the ocean floor.



# WEREWOLF

Werebeasts are believed to be men or demons who can transform into an animal at will. Although legends of werewolves and similar canines are the most common, other animals, including bears, panthers, and tigers, are known. Popular fiction has created its own myths about wolfmen and lycanthropy. In reality, the werebeasts of ancient legends are shape-changing predators of supernatural origin. Its true form is that of half-man, half-beast or the wolf-man, but the creature can magically metamorphosize into a full size predatory animal or human being. The metamorphosis magic is the only magic the creature knows, in both spell and ritual forms.

The werebeast is fairly intelligent and can, for brief periods, pass itself off as being completely human. However, it is a creature born to hunt and kill. That is its life, its purpose, its pleasure. Although as much animal as human-like, the creature enjoys deadly games of sport, and delights in the challenge of human combat to prove its superior cunning and skill as a primal hunter. In an earlier day these creatures

roamed in packs, and some even established little kingdoms where one or more were worshipped as gods or demons. Succumbing to the values of humankind, the werebeast has been known to steal and hoard valuables, such as gold, silver, gems and so on.

## The Werebeast

**Horror Factor:** 12 as humanoid wolf-thing or huge unnatural animal. The horror factor does not apply to human form.

**Alignment:** Any evil.

**Size:** 6-7ft tall in humanoid form, 5 to 6ft tall in animal form.

**Weight:** 200 to 300lbs (90 to 136kg).

**Armor Rating:** None

**S.D.C.:** 6D6 + 6 **Hit Points:** 6D6

**The Eight Attributes:** The number of six-sided dice are indicated as follows: I.Q. 2, M.E. 3, M.A. 3, \*P.S. 5, P.P. 4, P.E. 4, P.B. 3, \*\*Spd. 5

\*Physical strength is never less than 16.

\*\*Speed in humanoid form is determined by rolling 5 six-sided dice. Speed as a wolf is 32mph (50kmph), speed for all other animal types is 25mph (40kmph).





# GREATER BEINGS

Throughout the universe there are forces and life forms far different than anything we know on Earth. Forces which have visited our world many times throughout its history. Forces that primitive man recognized as demons and demigods of evil intent. A very correct identification, for while they are not demons or gods in the classic or religious sense, they are hideous, vile beings and every bit deserving the moniker demon. Beings with nothing in common with humans. Monsters so far removed from humanity that we are a totally alien and unimportant race, except as the plaything of the so-called "greater powers." Forces human-kind has always known as evil.

## GREATER BEINGS

Elementals (H.F. 12)  
Goqua (H.F. 18)  
Mindolar (H.F. 16)  
Vampires (H.F. 14)  
Ancient Gods and Demigods (H.F. 18)

## ELEMENTALS

### Earth, Fire, Air, Water

Elementals are greater supernatural beings who have been revered as gods, demigods, and nature spirits by ancient man. Fortunately, the appearance of an elemental in our world is extremely uncommon.

True elementals have no natural body, but are instead an energy or life-force with an alien intelligence. However, an elemental will almost always (90%) possess a lesser supernatural being, or human, or animal, or living tree, to anchor itself to our physical plane of existence. If it does not assume a physical body, it will automatically return to its own dimension in 2D6 hours. Whoever it possesses, that creature's memories, skills and essence are completely submerged by the elemental spirit. However, its physical body will retain that person's or creature's natural physical attributes, attacks per melee, S.D.C., and hit points. If psychic or magic, the elemental will ignore those abilities in favor of its own superior abilities.

Elementals are so alien to physical life-forms that they have no concept of society laws, rules, technology or even animal/human life. They are raw, primeval forces of nature that do as they please. They are also emotionally primal, and easily angered and provoked to violence. Elementals regard humans as a swarm of annoying insects and react by crushing them when irritated. The elementals' disregard for human life and their great power makes them attractive, but dangerous, pawns, sometimes used by arcanists and powerful supernatural beings.

*The following abilities are common to all Elementals.*

**Horror Factor:** 12

**Alignment:** Anarchist or miscreant.

**Size:** As an energy being, 10 to 100ft tall (3 to 30.5m).

**Weight:** None as an energy being.

**Armor Rating:** None as an energy being.

**S.D.C.:** Not applicable to energy being. **Hit Points:** 1000

**The Eight Attributes:** Not Applicable.



**Natural Abilities:** Impervious to all normal weapons, poisons, toxins, drugs, gases, fire, energy, and explosives; however, physical attacks can knock the creature down and explosives will stun it for 1D4 melees (15 to 60 seconds). *The creature is vulnerable* to magic, psychic attacks and silver. A weapon made of silver or coated in silver will inflict the usual damage for that weapon. *Other abilities include:* prowl — 80%, track by smell — 70%, nightvision — 300ft (91.5m) and bio-regeneration, restoring all lost S.D.C. and hit points within 24 hours.

**Magic Knowledge:** Metamorphosis: animal, metamorphosis: human, summon and control canine, and tongues.

**Psychic Abilities:** Sixth sense, see the invisible, mind block.

**Attacks Per Melee:** Four; claws do 1D6 plus P.S. bonus to damage, bite does 2D6 damage.

**Bonuses:** In addition to attribute bonuses, the creature is +2 to strike, +2 to parry, +3 to dodge, +2 to save vs magic, +6 to save vs horror factor.

**I.S.P.:** 4D6 **P.P.E.:** 2D4 × 10 + 10.

**Note:** Werebeasts prefer the wolf form above all others, and werewolves or beast dogs are common to legends of Canada, USA, Europe, Africa, Australia and Japan. Evil arcanists sometimes summon werewolves as assassins.





"EATER of the WINDS"

FRIBISSA 8/87



**I.S.P.:** None **P.P.E.:** 1D6 × 1000

**Attacks Per Melee:** *Two spell attacks* per melee regardless of spell level (1 through 15), with a saving throw of 16 or higher needed to save.

**Bonuses:** +5 to save vs magic, +4 to save vs psychic attacks, +14 to save vs horror factor, +14 to save vs possession.

**The Abilities and Powers of Each Type of Elemental are as Follows:**

## AIR

**Natural Abilities In Energy Form:** Impervious to all but one type of physical and energy attacks, poisons, drugs, toxins, gases, heat, cold, etc. *Natural Telepath*; Range: 200ft (61m). *Fly* and hover in energy form at a maximum speed of Mach one (670mph).

**Spell Abilities:** Heal wounds, restoration, seal, blinding flash, globe of daylight, see aura, see the invisible, thunderclap, levitation, fly, breathe without air, fingers of wind, float in air, calm storm, call lightning, wind rush, life drain, summon fog, summon rain, summon storm. **Note:** All spell ranges are 100 times the first level range; duration and damage are increased by 10 times — the maximum (the elemental can do less if it desires).

**The air elemental is vulnerable** to magic and psychic attacks. Also, the destruction of the possessed physical body will break its link to the material world and send it instantly to its own dimension. *In energy form*, the elemental can be destroyed by grounding a piece of hard metal, preferably iron or steel, and impaling the energy sphere with it, discharging the energy into the ground. The discharge does 2D6 × 1000 damage to everything within a 60ft area (18.3m).

## FIRE

**Natural Abilities In Energy Form:** Impervious to all physical and energy attacks, as well as poisons, toxins, drugs and gases. *Natural telepath* — 200ft range (61m), fly in energy form at a maximum speed of 200mph (321kmph).

**Spell Abilities:** Blinding flash, cloud of smoke, see the invisible, sense evil, extinguish fire, energy bolt, fuel flame, ignite fire, impervious to fire, impervious to energy, energy field, energy disruption, fire bolt, circle of flame, life drain, and turn dead. **Note:** All spells range are increased to a hundred times the first level range. Duration and damage are increased 10 times the first level duration and damage (normal damage from life drain but affects area).

**The fire elemental is vulnerable** to psychic and magic attacks. Water inflicts 2D6 damage per gallon in both physical body and energy form. As usual, destruction of its physical body will send it back to its own dimension. Piercing its energy form with a piece of hard metal that is ground will kill it by discharging the energy into the ground. The discharge does 1D6 × 1000 damage to a 60ft area (18.3m).

## EARTH

**Natural Abilities In Energy Form:** Impervious to all but one type of physical and energy attacks, as well as poisons, drugs, toxins, gases, heat, cold, etc. *Natural Telepath*; range:

200ft (61m). *Fly* and hover in energy form at a maximum speed of 200mph (321kmph).

**Spell Abilities:** See the invisible, sense P.P.E., shadow meld, climb, repel animals, all metamorphosis, purification of food and water, spoil food and water, time slip, life drain, animate and control dead, commune with spirits, negation, sickness, summon and control animals, summon canines, summon rodents, id barrier, create stone golem, restoration and transformation. **Note:** All spell ranges are 100 times the first level range; duration and damage are increased by 10 times — the maximum (the elemental can do less if it desires).

**The earth elemental is vulnerable** to magic and psychic attacks, as well as energy, but energy (heat, fire, laser, etc.) does half damage. As usual, the destruction of the possessed physical body will break its link to the material world and send it instantly to its own dimension. *In energy form*, the elemental can be destroyed by grounding a piece of hard metal, preferably iron or steel, and impaling the energy sphere with it, discharging the energy into the ground. The discharge does 1D6 × 1000 damage to everything within a 60ft area (18.3m).

## WATER

**Natural Abilities In Energy Form:** Impervious to all physical and energy attacks, as well as poisons, toxins, drugs and gases. *Natural telepath* — 200ft range (61m), fly in energy form at a maximum speed of 200mph (321kmph). Travel through water at Mach one (about 670mph).

**Spell Abilities:** See aura, see the invisible, breathe without air, extinguish fires, paralysis: lesser, swim as a fish, escape, calling, purification of food and water, constrain being, commune with spirits, exorcism, hallucination, negation, oracle, banishment, remove curse, summon fog, calm storm, sanctum, restoration and heal wounds. **Note:** All spell ranges are increased to a hundred times the first level range. Duration and damage are increased to 10 times the first level duration and damage (normal damage from life drain but affects area).

**The water elemental is vulnerable** to psychic and magic attacks. Energy, such as fire, heat, lasers, etc., will inflict *double damage*. As usual, destruction of its physical body will send it back to its own dimension. Piercing its energy form with a piece of hard metal that is ground will kill it by discharging the energy into the ground. The discharge does 1D6 × 1000 damage to a 60ft area (18.3m).

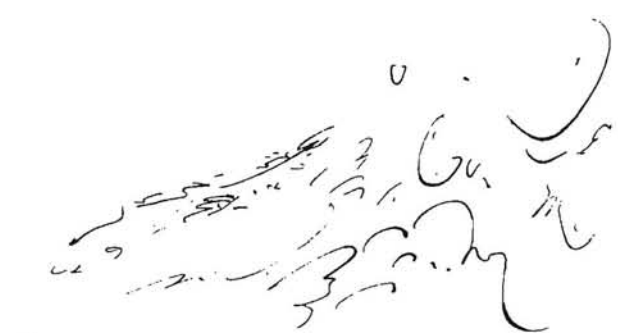



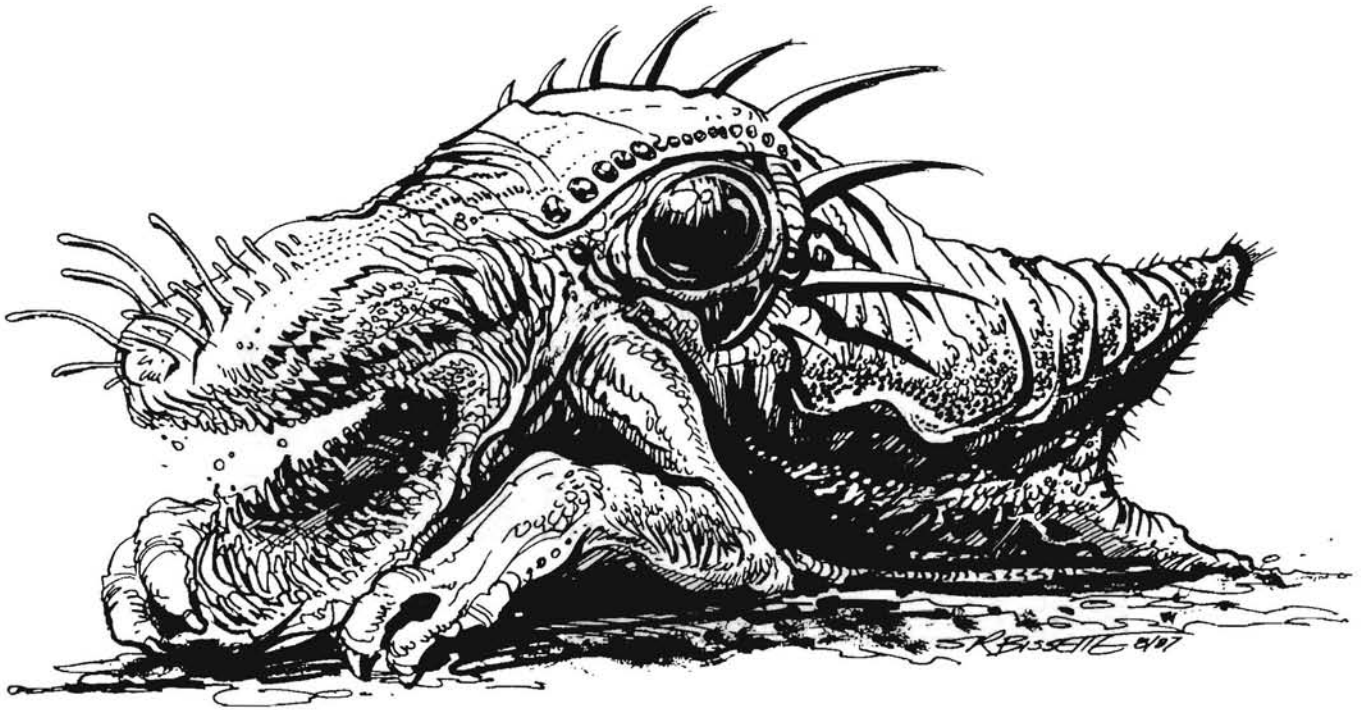

## GOQUA

### Masters of Deception

The goqua is a hideous creature that resembles a demonic slug or hellish larva in a pupal state. The slime covered horror stands eight feet tall (2.4m) and 20ft long (6.1m). The front is one gargantuan maw with three rows of jagged shark-like teeth (over 300 in all) and a dozen tiny tentacles waving like antennae. The powerful jaws are so large that it can bite an elephant in half. Beyond the jaw is a pair of massive, clawed arms that can reach 10ft (3m). Above the shoulder is its giant squid eye, rimmed by three foot long spikes. The top and rear section of the slug is plated with a tough cartilage and skin forming a natural armor hide.

Despite its gruesome appearance, the creature is an intelligent being with an insatiable curiosity. It finds humans especially intriguing because they are violent, clever, inventive, deadly, and oh so unpredictable. This makes humans delightful pawns in goqua games of manipulation. The goqua love to fabricate competitions for humans, pitting them against themselves, other supernatural beings, magic, or terrible trials of strength and ingenuity. It is possible that the Greek's and Roman's and many other societies/religion's belief that humans were the playthings of the gods arose from the intervention of the goqua. Certainly, legends and myths of demonic tempters include the goqua at the top of the list.

In addition to the goqua's own natural abilities, they are masters of magic. A skill they have learned to use in the most cunning of ways. As the tempters of man, they use metamorphosis often; combined with other magics and subtle tactics, the goqua have walked among humankind since the beginning of time.

One of these deceptive creature's greatest bones of contention is *its* perceived status among other demigods and super intelligences. Most treat the goqua as an *inferior* being. An attitude that irks these masters of subterfuge to no end. Thus, they have

made a point to sucker and manipulate these other, supposedly, superior beings in its games with men, playing each against the other, but always slipping humans an ace in the deck, some little edge that, if the human is clever, will help defeat the self-proclaimed omnipotent ones. A most amusing and satisfying game, of which the goquas never tire. **Victor Lazlo**, in one of his diaries, wrote of a strange dream he had at the pyramid of Giza. *"... and among the scores of figures, all featureless in shadow, stepped out a coyote whom I instantly knew to be 'the' Coyote of the American plains indian's legend. He smiled a coy smile as some of the other figures stepped out of the shadows. All figures from legend, Thoth, Loki, Mercury, Chantico, and Mephisto, all ancient gods of mischief who tricked and used their fellow gods with cunning, for their own winsome purposes. The Coyote spoke the only word in my dream, 'Goqua,' smiled, with its tongue lolling to one side, winked, and I awoke. Makes me wonder."*

## Goqua

**Horror Factor:** 18

**Alignment:** Usually anarchist or aberrant, but can be one of the other evil alignments too.

**Size:** 8ft tall (2.4m), 20ft long (6.1m).

**Weight:** About two tons.

**Armor Rating:** 12

**S.D.C.:** 1D6 × 1000 **Hit Points:** 1D4 × 1000.

**The Eight Attributes:** All are superior to humans. All range between 22 to 28.

**Natural Abilities:** Impervious to cold and poisons, toxins, drugs and gases. Fire resistant (does half damage), turns invisible at will, and understands, reads and speaks all languages. The goqua is vulnerable to physical, energy, psychic and magic attacks.

**Psychic Abilities:** Astral projection, death trance, divination, empathy, empathic transmission, meditation, mind block, see aura, see the invisible, suggestion, telepathy and total recall.



**Magic Knowledge:** ALL ritual and spell invocations of magic, levels 8 through 15. Will also know 4D6 spells from levels 1 through 7 (GM choice). **Note:** Psychic and magic are performed at 10th level proficiency.

**Attacks Per Melee:** Five hand to hand; claws do 4D6 damage plus P.S. bonus of at least +7, bite does 2D6×10. Three psychic attacks per melee. Magic has its usual limitations.

**Bonuses:** In addition to attribute bonuses, the creature is +2 to save vs magic, +2 to save vs psychic attack, impervious to mind control, +15 to save vs horror factor and can not be possessed.

**I.S.P.:** 1D6×10+30 **P.P.E.:** 2D4×100+200.

**Note:** If destroyed, the goqua disappears as if it never existed.

## MINDOLAR

### The Mind Slug

The mindolar are giant slug-like beings which can be summoned from another dimension by men of magic. The mindolar never come into our world intentionally. A mindolar can not be controlled by humans, because of its superior psychic mind, but it can control humans like a puppet on a string. This makes them very attractive to evil arcanists. The arcanist's edge is his bargaining chip. Only he can send the mindolar back to its own dimension. This makes the slug easy to bargain with, because it hates our dimension and only wants to go back home. Furthermore, human life is an enigma that means nothing to it, so it will gladly do whatever must be done to go home. A mindolar is observant and quick to react. If betrayed or tormented, it is likely to make a quick snack of the summoning mage (the only thing humans are good for, food).

Mindolar have a formidable array of psychic abilities, but its most dangerous power is its *mind controlling bite*. The victim of a bite must roll to save vs magic (a 15 or higher). A successful save means the character is still himself. Three successive saves

against the magic bite means the character is immune to ALL of its mind altering powers and will be perceived to be a serious threat to its existence. A **failed roll** places the person under the slug's complete control. The effect is exactly like the magic spell "domination," except there is no limit to the range or duration. The bite also enables the mindolar to place the victim in a trance, also identical to the spell "trance." The person is enslaved, with no chance of fighting free of its control, as long as the creature is alive or in our world. When slain or sent to another dimension, the slug's mind control is broken and the victim(s) return to normal. **Note:** A single mindolar can control as many as 200 human beings simultaneously. A mind slug that is trapped in our world will desperately seek a way out, but will also become increasingly ruthless and cruel, venting its frustration on the puny human race.

## Mindolar

**Horror Factor:** 16

**Alignment:** Anarchist, aberrant or any evil.

**Size:** 7ft (2.1m) long.

**Weight:** 600lbs (272kg).

**Armor Rating:** None

**S.D.C.:** 1D6×100. **Hit Points:** 2D4×100.

**The Eight Attributes:** I.Q., M.E., and M.A. are all superior to a human's, ranging around 24 to 30. The following indicate the number of six-sided dice. P.S. 2, P.P. 3, P.E. 4, P.B. 1, Spd. 2.

**Natural Abilities in Insect Form:** Understands all languages, but must use a human pawn to speak. Vulnerable to all forms of attack, with the possible exception of psychic. Regenerates at a rate of 4D6 S.D.C. and 1D4×10 hit points per hour. Resistant to cold and drugs/poisons (½ damage). Impervious to mind control of any kind.

**Psychic Abilities:** All psychic sensitive powers, plus exorcism, healing touch, increased healing, induce pain, induce sleep, and resist fatigue. All at 10th level proficiency.





**Attacks Per Melee:** Three psychic or three physical attacks; bite inflicts 2D6 damage plus the victim must roll to save vs magic mind control (15 or higher). The tiny hands inflict 1D6+2 damage.

**Bonuses:** +10 to save vs psychic attack (this takes into account the high M.E.), +3 to save vs magic, +10 to save vs horror factor, +4 to parry. It can not be possessed.

**Magic Abilities:** None

**I.S.P.:** 2D6×100 **P.P.E.:** 1D4×10

**Note:** The body of the mindolar automatically returns to its own dimension when killed.

## INTELLIGENCES

### The Ultimate Evil

Unlike the elementals and mindolar, who view life on Earth with indifference, there are forces equally as powerful, but infinitely more sinister. Intelligent beings, like the Goqua, only much more evil, who use the Earth and its people as playthings in a grander game. They are the forces of evil that have plagued man since the dawn of time. Insidious, corrupting evil that threatens the fate of the human race. Creatures whose sole enjoyment is the torment and subjugation of humans. Fiends that cultivate and feed on the suffering of other creatures. Demons who find delight in tearing out a person's life with their teeth.

## VAMPIRES

One such dreadful power is the vampire. A complex being that can divide its life-force like an amoeba, to create an army of horrific, blood-sucking ghouls to feed upon humans. The eerie thing can fragment a part of its essence and send it through a dimensional rift or portal, or allow it to be *summoned* by a foolhardy practitioner of magic. Delivered into our world, the invisible life-force must bond with a living human to anchor itself to our dimension. A *willing* subject must be found. A suitable subject who has already been corrupted by dreams of power, greed, revenge or hatred. Such a person can be beguiled by the promise of god-like power, the promise of eternal life and the opportunity to become more than human.

The fool who accepts such a deal has his/her life-essence torn from its living shell of flesh and blood, and cast into the jaws of death. Room must be made for the body's new master. The lost soul who stooped to make such an agreement has the pleasure of knowing that it will be his or her image/likeness that will be known as a vehicle of power. That is all.

A vampire born, the true nightmare begins. Vampires live to dominate, terrify and feed on inferior human life. Humans are cattle to be quartered and devoured. Playthings to satiate sadistic and unnatural pleasures. The hellish fiend delights in the horror, pain and suffering of humans, immersing itself in dark emotions, reveling in their ecstasy. A vampire is more than a drinker of blood. It is also a psychic vampire, feeding on potential psychic energy and an empath, soaking up the delectable quintessence of life tinged with the tantalizing flavor of horror that only it can evoke.

Vampires have been called a pestilence, an apt description, for as it nightly feeds its insatiable cravings, it spreads the nightmare. Legend says that the victim of a vampire will rise again

within three days as one of the undead. Not true. Most of its victims are nothing more than food, trapped and horribly, painfully slain. But the first vampire, the true focus of the intelligence's fragmented essence, can fragment a piece of itself again and again into evil or *corrupted* people who willingly accept the gift (the curse) of vampirism. Just as it did to its first victim, the person's life-essence is destroyed and the vampire is born. These vampires are primal creatures of the night, stalking their human prey with an unquenchable blood lust. These secondary vampires are far less intelligent and more animal like. Mere shadows of the master intelligence that created them. Fortunately, the bite from these silicrum can *not* create more vampires, only the master vampire has that ability. However, since it is impossible to discern who bit whom or whether the individual was corrupted or not, humans wisely developed a policy of treating all victims with the presumption that they are vampires and will return from the dead. To insure that this will not happen, a wooden stake is plunged into its heart, the head decapitated, and both parts are then cremated or buried in separate graves.

Both the master vampire and its army of shadow selves (lesser vampires) possess super human strength, can metamorphosis into a bat or wolf, and fly in bat form. The empathic nature of the creature makes them uniquely vulnerable to a human's intense belief in a good, protective, all powerful god. Thus, the person can project a psychic energy that hurts and repulses the vampire when a crucifix or similar, powerful religious icon is used to ward off the hell spawned evil. The only condition is that the human must truly believe in that god and in the power of the icon. Without belief there is no psychic focus and the symbol is a worthless trinket.

Both types of vampire also possess an unbelievable *regeneration power* that can replace severed limbs and restore bodies burned down to the bone. The use of the wooden stake plunged into the heart somehow *disrupts* the alien life-essence, paralyzing it, but *not* killing it. Chopping off the head adds to the thing's *comatose* condition, but unless the head is removed from the body and both destroyed by fire or buried apart in separate graves, the damned creature could rise again. To revive the vampire, the severed head must be placed with the body and the stake removed. That night the creature will rise again. For this reason, it is not safe to stake a vampire and leave it or bury it whole, because removal of the stake will revive the horror.

The first vampire is the true vampire, also known as the lord of the vampires, and is psychically linked to its lesser halves. Thus, it can mentally summon them to him or be mentally directed. The vampire lord does *not* see and experience everything they do, like a familiar, but he does know approximately where each one is located, feels when one has made a kill, and knows when one has been killed by the stake. All lesser vampires are loyal and submissive to the lord and obey his commands without hesitation or question. If the master vampire is slain, its lesser shadow selves will wander the world without direction, feeding on humans until destroyed. Whenever any are completely destroyed, the life force fragment returns to the intelligence a dimension away, where it plots new adventures for the realm of man.

*The master vampire* is much more cunning, elusive and powerful than the lesser vampires. In addition to some mystic spell abilities, the creature is an excellent strategist and tactician,







calculating its every move like some demonic general sent on a covert operation to invade and neutralize the enemy. It will make no foolish last stands, nor fight to the death if escape is possible. The creature is treacherous and a master of deception. A moment's hesitation on the part of a human opponent may be all it needs to regain an upper hand. Although vulnerable to magic, the vampire is not affected by the turn dead spell because, in a strange way, it is not dead. Likewise, the animate and control dead spells do not apply to vampires. Exorcism will not work either, because the vampire has not temporarily taken possession of a person, suppressing the life-force in that body, but has destroyed the human essence and has replaced it with its own.

## The Master Vampire

**Horror Factor:** 14

**Alignment:** Diabolical or Miscreant

**Size:** Human

**Weight:** Human

**Armor Rating:** None

**S.D.C.:** 2D4 × 10 **Hit Points:** 1D6 × 10

**The Eight Attributes:** They are always consistent, so fewer dice rolls are needed. I.Q. 12+1D4, M.E. 1D4+16, M.A. 1D6+16, P.S. 1D6+24, P.P. 1D6+14, P.E. 20, P.B. 1D6+16, Spd. 1D6+20.

**Natural Abilities:** 1) *Impervious* to normal weapons, poisons, toxins, drugs, gases, and fire. High-powered energy, like electricity and lasers, will hurt it, but inflicts no solid damage. A massive jolt of electricity or explosives will stun the fiend for 1D4 melees (15 to 60 seconds). *Wooden weapons*, such as spears, arrows and wooden stakes, driven *through the heart* will incapacitate the vampire, paralyzing it completely. Shooting or impaling the creature with wooden weapons anywhere else on the body will hurt, but inflicts no damage whatsoever. The vampire can only be destroyed by driving a wooden stake (or similar object, spear, arrow, etc.) through the heart and decapitating it, and then burning the body and head or burying them separately. **Note:** The light of day (sunlight) is physically painful and can destroy the nocturnal monster if it is trapped in sunlight. *Sunlight inflicts 6D6 points of damage per each melee exposed.* A cloudy day is no protection, although damage is reduced to 3D6 per melee. However, the creature can function in artificial light without difficulty, and can even move about during the day as long as windows are secured to allow absolutely no sunlight to enter. Even a beam of sunlight will cause 6D6 points of damage (no, a laser beam is not sunlight). 1) *The magic spell "globe of daylight,"* does 3D6 damage and not the full 6D6. 2) **Bio-regeneration** will completely restore the vampire from all damage (unless destroyed) during the ten hours that it sleeps. 3) **Can turn into a bat or wolf at will.** As a bat the vampire can fly up to 20mph (32kmph) and eavesdrop as well. As a wolf the creature can run for hours at 32mph (51kmph) and has four bite attacks per melee, inflicting 3D6 damage each, and track by smell — 65%. The bat form offers only two attacks doing 2D4 damage each bite. 4) **Nightvision** — 600ft (183m). 5) **Prowl** — 80%. 6) **Has no reflection** in mirrored surfaces. 7) **Can turn others** into vampires at a rate of one per night. **Psychic Abilities:** Death trance, empathy, mind block, presence sense, sense evil, suggestion (hyp-

nosis is often used to control human pawns and victims), deaden pain, induce sleep. It also has a sort of telepathic or empathic link with its lesser minions. Equal to a 6th level psychic sensitive.

**Magic Abilities:** Only the master vampire has magic knowledge! Includes: Calling, see the invisible, sense P.P.E., befuddle, fear, turn dead, float in air, trance, domination, tongues, eyes of thoth, commune with spirits, spoil (food/water), metamorphosis: mist, summon and control canine, summon and control rodents, summon fog, create zombie, summon lesser being and summon greater being (to access its other, more powerful, self). All magic invocations are known as spells and rituals. Equal to a 6th level arcanist.

**Attacks Per Melee:** Four hand to hand; extraordinarily strong punches and kicks inflict 2D6 damage plus P.S. bonus of at least +10. Bite also inflicts 2D6 damage, but no P.S. bonus. Magic has its usual limitations.

**Bonuses:** In addition to attribute bonuses, the vampire is +1 to save vs psychic attacks, +1 to save vs magic, +10 to save vs horror factor and it can not be possessed.

**I.S.P.:** 2D6 × 10 **P.P.E.:** 2D6 × 10 + 40

**Note:** The legend about garlic holding a vampire at bay has no essence of truth.

## THE SECONDARY VAMPIRE

### *The Minions of the Master*

**Horror Factor:** 14

**Alignment:** Diabolic

**Size:** Human

**Weight:** Human

**Armor Rating:** None

**S.D.C.:** 1D4 × 10 **Hit Points:** 1D4 × 10.

**The Eight Attributes:** Are not really applicable; low animal intelligence (equal to an I.Q. about of 4 or 5), compelled to hunt and kill, and drink its victim's blood. Physical strength is P.S. 20 (+5 to damage). Spd. is 16.

**Natural Abilities:** Are the same as the master vampire's number one through six.

**Psychic Abilities:** Death trance, empathy, and sixth sense. Equal to a second level psychic.

**Magic Abilities:** None

**Bonuses:** +5 to damage (P.S. bonus), +2 to strike, +3 to parry, +2 to dodge, +1 to save vs magic, +2 to save vs psychic attack, +6 to save vs horror factor and can not be possessed.

**I.S.P.:** 4D6 **P.P.E.:** 6D6

**Note:** Totally obedient to the master.

## THE VAMPIRE INTELLIGENCE

### *Evil From Another World*

**Horror Factor:** 15

**Alignment:** Miscreant or Diabolic

**Size:** 8ft tall (2.4m), wingspread — 25ft (7.6m).

**Weight:** 600lbs (272kg)

**Armor Rating:** None

**S.D.C.:** 1D4 × 100 **Hit Points:** 3D6 × 10

**The Eight Attributes:** I.Q. 1D6+16, M.E. 1D6+16, M.A. 1D6+22, P.S. 1D6+24, P.P. 1D6+16, P.E. 1D4+20, P.B. 1D4+12, Spd. 1D6+20.







**Natural Abilities:** Identical to the master vampire's number one through seven. Can also fly at a speed of 60mph (96kmph).

**Psychic Abilities:** Identical to the master vampire, but equal to 10th level of experience.

**Magic Abilities:** Includes those listed under the master vampire and includes all ritual invocations of levels eight through fifteen. Equal in power to a 10th level arcanist.

**Attacks Per Melee:** Six; claws inflict 4D6 damage plus at least +10 P.S. bonus, bite inflicts 3D6 damage.

**Bonuses:** In addition to attribute bonuses, the creature is +1 to save vs magic and psionic attacks, +15 to save vs horror factor and can not be possessed.

**I.S.P.:** 1D6 × 100 **P.P.E.:** 1D6 × 1000.

**Note:** The only way a supernatural intelligence can die is to have its physical body destroyed. Consequently, no vampire intelligence has *ever* been known to take that risk by entering into our dimension. It is far safer to send a fragment of its essence into our world. The vampire intelligence experiences everything its fragmented life-forces experience (all the vampires), and directs them from the safety of its home dimension. Remember, the master vampire and its minions are all a part of the greater being, the vampire intelligence.

## SUPERNATURAL INTELLIGENCES

### The Source of Evil

Supernatural intelligences are malignant forces of evil dedicated to the propagation of misery. They know not of compassion nor regret, and exist for the sole purpose of spreading hatred and sorrow. They themselves defy our understanding of life as we know it. They are apparently beings that straddle both the physical and psychic planes of existence. Beings of both flesh and spirit. It is a union that enables them to divide their life-force into multiple facets of evil intellect and send these extensions of themselves to other worlds, in entirely different dimensions.

The process must be vaguely like the psychic human's ability to project himself into the astral plane, a dimension closely linked to our own. The difference is that the astral traveler leaves his physical body completely devoid of his life essence. The body is alive, but its intellect and motivating life force is in the astral plane. The body is an empty shell, unable to move, let alone think and function. Yet these alien intelligences can project a portion of their essence, like the astral body, creating an independent creature of psychic energy while the body retains its own identity and functions as normal. It is now two completely functioning, living creatures, one of energy and intellect, the other equally intelligent and linked to the physical and psychic world as always. The one is now two, and although both can function independently, each knows exactly what the other is experiencing the moment it happens.

It is the psychic energy being that is sent to Earth to torment and beguile humans. The evil force is the manifestation of what our ancient ancestors knew as evil gods, demigods, devils and demons. Powerful creatures of magic who could possess a man and make him more than human. Wicked entities that would strike the most vile of pacts with equally ruthless men. Pacts of blood and violence, pain and sorrow, in exchange for power, wealth, or vengeance. For these invisible fiends can offer much in the way of magic and evil counsel.

Most often, the evil intelligence waits until it feels the mystic call of a summoning. This is a welcomed opportunity because it means a desperate or foolish, or maniacal, human is knocking at its door. A door it gladly opens, sending its psychic energy self into our dimension. The energy being is naturally invisible, but will often use magic or psychic abilities (like ectoplasm) to create some sort of image that the summoning mage can recognize. The form may be a monstrous apparition or an illusion of a less frightening visage. The specific words and name in the invocation will clue it as to which mythic demon is expected to appear, or what might be expected of it. A quick telepathic and/or empathic scan, unless blocked, will clarify the summoner's expectations and desires.

Contact made, the creature will listen patiently to all requests. The summon greater being pentacle can summon and protect the mage from a greater being, but it can *not* enforce his will over it. No mortal man can dominate any of the greater beings. If terms are inadequate, it may enforce its own, but more often it *appears* to be a surprisingly understanding and compassionate ally. Like a pusher selling drugs, the first few samples are free or cheap. It is only after the person is hooked on the power, or caught in the middle of a deadly game, that the cost rises dramatically. If the being likes what is happening, it may honestly be of great assistance, especially if the circumstance is one of delightful treachery or will inflict much sorrow. It respects truly cunning evil and will fondly remember any human who impressed it with possessing that rare quality. If the mage or individual is believed to be a kindred dark soul, it will help him or her survive to inflict more treachery later as one of its unwitting agents of evil. However, it will rarely interfere in the overall clash between good and evil, for it is a wrestling match that it enjoys intensely. If one agent falls there is always another to take his place and the game continues.

The creature will usually offer one of the following: *the gift of power, the gift of magic, or the gift of union*. The gift of power and magic knowledge requires that the psychic being anchor itself to our world. To do this it will require a *host body*. Usually an innocuous animal, such as a cat, dog or bird. With the summoner's permission, it will possess the animal and is ready to begin. This is where the concept of a demon familiar arose.

**The gift of power** is an illusion in which the human recipient believes he has been magically granted superhuman abilities. In a way, he has, except the power is not drawn from some inner strength, but directly from the alien being. The creature projects a fraction of its power into its human pawn, giving him a taste of true power. It is only after the character has grown to love his power that he learns it is the demonic being that holds and gives the power. A power *it* can cut off with a mere thought. Suddenly, it is the mage who is a slave to the intelligence, as long as he covets that power.

#### The Gift of Power

*Four Abilities can be Selected from the Following:*

- Add 1D4 × 10 + 10 to I.S.P.
- Add 1D4 × 10 + 20 to P.P.E.
- Impervious to poisons, toxins, drugs, and gases.
- Impervious to fire.
- +2 to save vs magic.
- See the invisible.



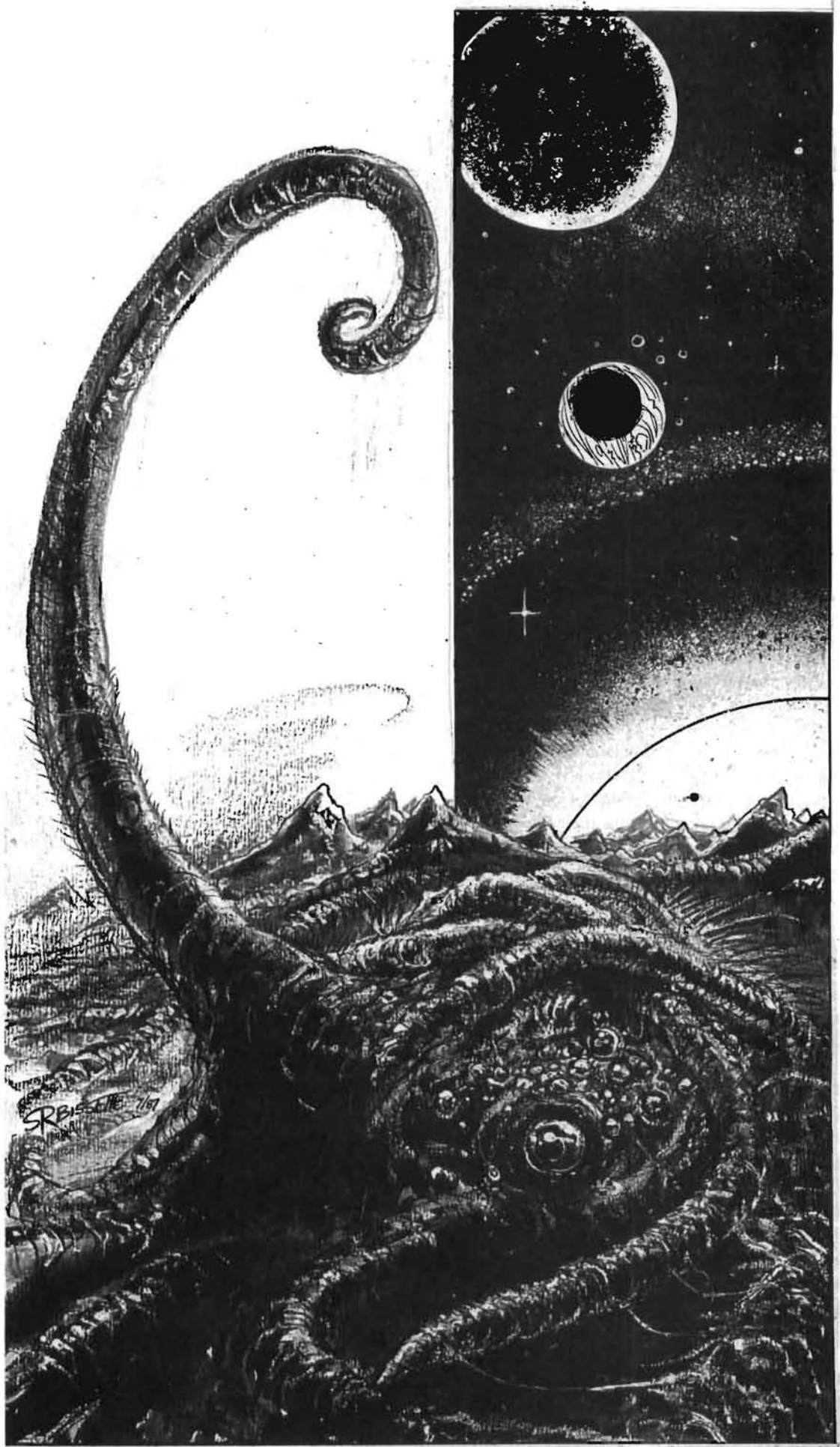



- Sixth sense
- Clairvoyance
- Increased physical strength; raise to P.S. 20.
- Increased physical prowess; raise to P.P. 20.
- Increased physical structure; add  $1D6 \times 10$  to S.D.C.
- Bio-regeneration; restores  $4D6$  S.D.C. and  $2D6$  hit points per hour.

**Note:** One more power can be awarded if the creature decides to be generous. The fifth power can be granted immediately or as an incentive at a later time. Remember, it is the demon familiar animal that is the source of the power.

The **gift of magic** will have the demon familiar teach several spells, or rituals, but only after the evil arcanist has proven himself, or has fulfilled the conditions of the pact. In the meanwhile, the creature will immediately teach him *two* low level spells (pick from levels one or two). It can also be convinced to cast magic for his benefit. Once he is proven to be worthy of the being's consideration, it will begin to offer favors and magic knowledge in return for doing special things for it. These special activities may include theft, murder, blood sacrifice, extortion, torture, etc., all calculated to satisfy some ulterior motive of the being. The mage is a pawn. *Other fringe benefits received from this deal are:* +1 to save vs magic, +1 to save vs horror factor and add 10 P.P.E.

The **gift of union** is the ultimate reward of power, because the summoning character willingly allows the horrid creature to share his body. The union fuses man with monster, but is not a classic possession, because the creature allows the human's essence to share control of the host body. The union instills a great number of changes. First, the character's alignment immediately changes to miscreant evil. Suddenly, the person will have a whole new perspective on the world. He or she, will realize that the end always justifies the means. He will feel superior to all other life-forms and realize that he was meant to be revered as a god. A new confidence will wash over him and he will know that anything is within his grasp. The character will be ruthless, merciless, and unfeeling toward his fellow humans. They are like ignorant savages to be used and abused as he desires. A voice in his head will assure him that this is all true. That same voice will implant suggestions, urge violence and entice acts of cruelty.

#### **Powers and Abilities Include:**

- All the magic known by the intelligence. But it is only the creature part of the human who can use its knowledge. The alien intelligence may share the same human body, however, it is still in *complete* control of its mind and powers. It is a question of whether the two work as one or work against each other. Note that the creature can also cancel any and all of the following abilities if it so desires.
- The creature also maintains control over its formidable psychic abilities too. However, it will use those powers for the benefit of them both if all is going well.
- $2D4 \times 10$  S.D.C. is added.
- $3D4 \times 10$  I.S.P.
- $2D6 \times 100$  P.P.E. are combined with the human's P.P.E.; both the creature and the human can draw on the total available P.P.E.
- Adds one hand to hand attack per melee.

The "gifts" are powers that are provided as a result of an amicable arrangement. However, these supernatural beings can elect to take a body by force, a process called possession. A possessed person or animal is completely dominated by the possessing force. Basically, the creature has commandeered a body like a crook might steal a car. The possessing force has all the same powers as the demon familiar. *Also see possession.*

**Note:** The alien intelligence will possess a person to cause pain and sorrow or to initiate its own diabolical game with the humans. Why? Just for sadistic pleasure, of course.

## **Demon Familiar**

**A typical extension creature of psychic energy from an intelligence in another dimension.**

**Horror Factor:** 10

**Size:** Animal rarely larger than a dog.

**Weight:** Varies with the animal.

**Armor Rating:** None

**S.D.C.:**  $2D4 \times 100$  **Hit Points:**  $2D6 \times 10$  for energy being.

**The Eight Attributes:** Not applicable; extremely intelligent (I.Q. 17), cunning, devious, treacherous. Possesses the physical abilities of the animal.

**Natural Abilities:** (As an energy being) Invisible; impervious to all physical attacks, including chemical and energy, hovers and flies at a speed of 200mph (321kmph). Ethereal/intangible, meaning it can pass through solid matter. Can use only empathy, telepathy, sense evil, sense magic, see aura and see the invisible psychic powers while in energy form. Can not use any other psychic powers or magic until a physical, living host body is inhabited.

**Psychic Abilities:** *Roll Percentile dice to determine type and abilities:*

1-20 All psychic healer.

21-40 All psychic sensitive.

41-60 All physical psychic.

61-79 All psychic sensitive and healer.

80-89 All physical psychic and psychic sensitive.

90-00 ALL psychic abilities.

All psi-powers are equal to a 6th level psychic.

**Magic Knowledge:** (Available only when in a physical host body) Knows summon greater being (to access other self), summon lesser being, create mummy, all curses, wards, locate, heal wounds, restoration, time slip, and both circles of protection and tongues are known as spells and ritual invocations. Also knows all the spell invocations of levels 1D6. Roll one six-sided die to see how many levels of spells are known. For Example: A roll of a four means all spells from levels 1-4 are known. A roll of two means only levels one and two are known. None of these are known as rituals. *Equal to a 6th level arcanist.*

**Attacks Per Melee:** Three, but inflicts double the normal damage for that animal.

**Bonuses:** The demon animal is +4 to save vs magic, +4 to save vs psychic attack, +10 to save vs horror factor, +2 to strike, +2 to dodge, +2 to damage.

**I.S.P.:**  $3D4 \times 10$  **P.P.E.:**  $2D6 \times 100$ .

**Note:** The summon greater beings pentacle can be used to access its more powerful self, during which the greater creature can assist its lesser counterpart by casting magic through



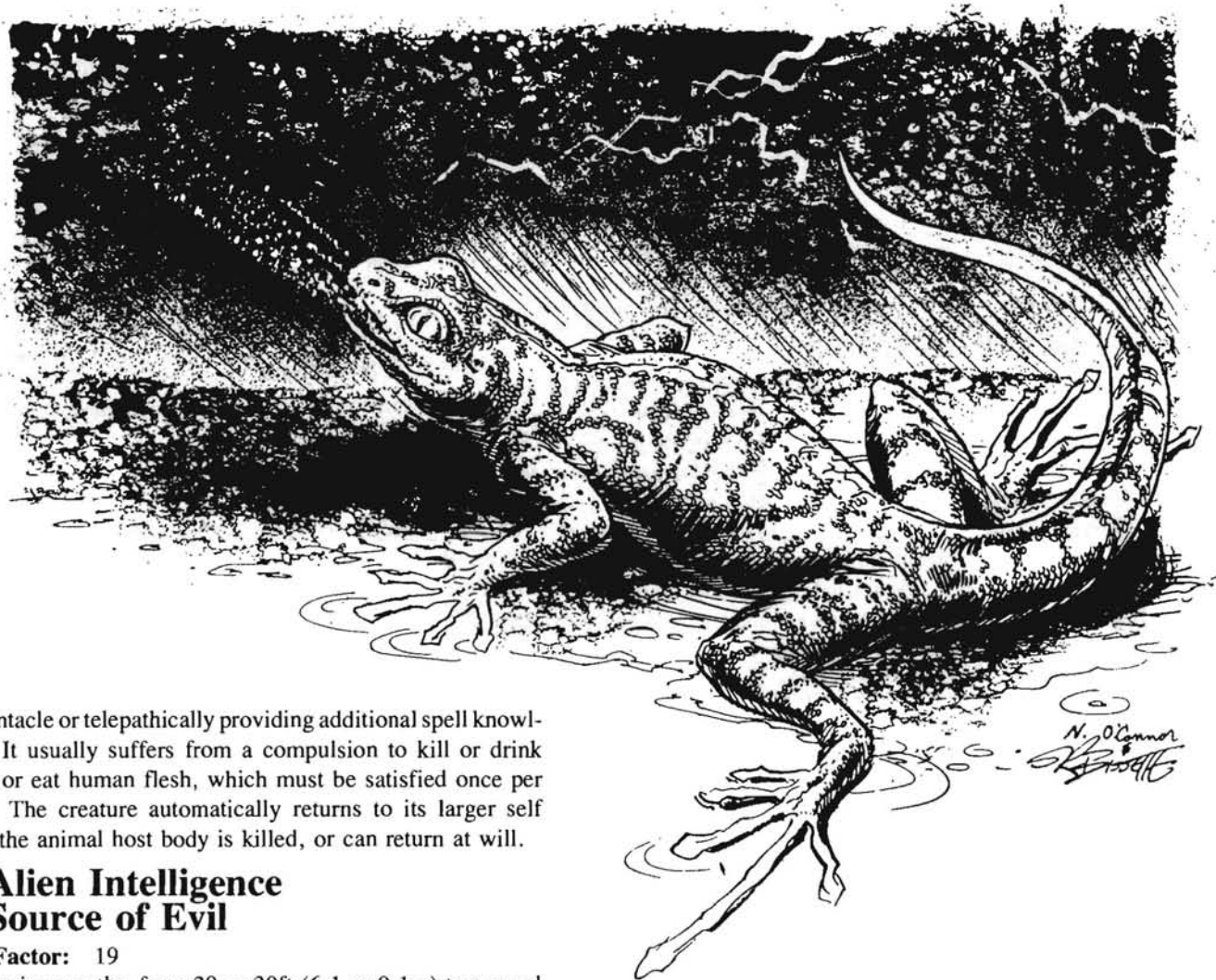

the pentacle or telepathically providing additional spell knowledge. It usually suffers from a compulsion to kill or drink blood or eat human flesh, which must be satisfied once per week. The creature automatically returns to its larger self when the animal host body is killed, or can return at will.

## The Alien Intelligence The Source of Evil

**Horror Factor:** 19

**Size:** Varies greatly, from 20 or 30ft (6.1 or 9.1m) to several hundred feet.

**Weight:** Varies greatly.

**Armor Rating:** 12

**S.D.C.:** 2D6 × 1000 **Hit Points:** 4D4 × 1000.

**The Eight Attributes:** Not applicable; I.Q. is genius level (I.Q. 28), cunning, deceptive, and treacherous.

**Natural Abilities:** Vary somewhat from creature to creature, but usually include: Resistant to physical and energy attacks (do half damage). Fire, yes, plain old fire, does double damage, and sunlight reduces its magic powers by half. Impervious to poisons, toxins, drugs and gases. Does not breathe air. Regenerates at a rate of 2D6 × 10 S.D.C. and 1D6 × 10 hit points per hour and can completely regenerate missing limbs within a 24 hour period.

**Psychic Abilities:** *Roll percentile dice to determine type and abilities:*

- 1-20 All psychic healer.
- 21-40 All psychic sensitive.
- 41-60 All physical psychic.
- 61-79 All psychic sensitive and healer.
- 80-89 All physical psychic and psychic sensitive.
- 90-00 ALL psychic abilities.

All psi-powers are equal to a 12th level psychic.

**Magic Knowledge:** Knows ALL spells and rituals and is equal to a 12th level arcanist. Sunlight reduces the level of power by half (level 6).

**Attacks Per Melee:** 1D6 physical attacks per melee, usually inflicting around 6D6 + 6 damage.

**Bonuses:** +4 to strike, +4 to parry and dodge, +15 to save vs horror factor, +10 to save vs magic, and +8 to save vs psychic attacks.

**I.S.P.:** 1D6 × 1000 **P.P.E.:** 4D6 × 1000.

**Note:** The physical form of these horrendous creatures is never humanoid. Generally, its form is a mass of undulating tissue with multiple eyes and tentacles or insect-like appendages.

## SPECIAL NOTE

There are dozens of mythological ghosts, demons and monsters. To fit them all in this book is impossible without adding another hundred pages. Consequently, we have selected just a handful of the more famous, traditional, or important supernatural beings. Future supplements will provide more.

One of the aspects that got shortchanged in this basic rule book is the concept of *technological horror*. Could a Doctor Frankenstein type character breathe life into a man-made corpse. Could he accidentally, or intentionally, get a tectonic entity to bring his piece-work creation to life? What of other combinations of technology and the supernatural. What of genetic experiments gone wrong? Mutations and so on. Unfortunately, we could only squeeze so much into this already huge volume. So watch for technological horror as a future supplement.



# MONSTER RELATED ITEMS

## THE EVIL ARCANIST A Quick Roll Villain

Undoubtedly, characters will encounter evil arcanists. An evil arcanist is a character who uses his/her mystic knowledge to exploit those around him for his/her own selfish reasons. They are almost always bitter or angry men and women motivated by hate, revenge, greed or power. Occasionally, an arcanist will become a witless pawn of a supernatural creature. Others become cruel and sadistic like the inhuman monsters they associate with. The latter are the worst, for they perpetuate wickedness for the sheer, depraved pleasure of it.

Ultimately, these are despicable, nefarious characters who will stop at nothing to achieve their goal. An evil arcanist will make blood sacrifices, steal, murder, and consort with supernatural fiends. Such a villain will gleefully inflict curses, cause sickness, torture and torment his victims, enslave entities, create zombies and summon hellish creatures to do his bidding.

The evil arcanist will almost certainly prefer the power of ritual magic and establish a cult or secret society. The vile sorcerer may even sell his services to the underworld. The organization may be a small hand-picked group or coven, or it may span the globe, with special operatives located at key places of operation.

The following tables should enable the game master to quickly roll up an arcanist and his minions. These tables in no way indicate the full range of potential for a villain as flexible as this, but it is a good way to get started.

### The Evil Arcanist

#### ONE: Gender

- 1-60 Male
- 61-00 Female

#### TWO: Alignment

- 1-25 Anarchist
- 26-50 Miscreant
- 51-75 Diabolic
- 76-00 Aberrant

#### THREE: Level of Experience

- 1-20 Second
- 21-40 Third
- 41-60 Fourth
- 61-80 Fifth
- 81-00 Sixth

#### FOUR: Potential Psychic Energy (P.P.E.)

Roll  $1D4 \times 10 + 1D6$  for each level of experience.

#### FIVE: Spell Knowledge

Roll to determine the number of spells known for each level listed. Then make a selection.

- Level One — 2D4
- Level Two — 2D4

- Level Three — 2D6
- Level Four — 1D6
- Level Five — 1D4
- Level Six — 1D6
- Level Seven — 1D4
- Level Eight — None
- Level Nine — 1D4
- Level Ten — None
- Level Eleven — 1D4
- Level Twelve — None
- Level Thirteen — None
- Level Fourteen — None
- Level Fifteen — None

#### SIX: Cult Leader

- 1-35 No
- 36-50 Yes, but broken up by interference from the law (they'll pay for that). Just beginning to re-establish the cult; 1D6 members recruited so far.
- 51-65 Yes; coven of 12 members, each with an average of 16 P.P.E.
- 66-75 Yes; just starting, has recruited  $2D4 + 1$  members, each with an average of 13 P.P.E.
- 76-90 Yes; medium-sized group,  $3D6 + 10$  fanatic followers plus another 4D6 fringe members.
- 91-00 Yes; large secret organization, core group is  $3D6 + 10$  members (all average 15 P.P.E. each) plus  $4D6 \times 20$  secondary members and non-occult agents.

#### SEVEN: Supernatural Guardians or Slaves.

- 1-10 Tectonic Entity
- 11-20 Zombie
- 21-30 Gargoyle
- 31-40 Gremlin
- 41-50 Grave Ghoul
- 51-60 Mummy
- 61-70 Poltergeist
- 71-00 None

#### EIGHT: Familiar

- 1-20 Had one but it was killed.
- 21-30 None
- 31-40 Dog
- 41-50 Cat
- 51-60 Weasel
- 61-70 Rat
- 71-80 Raven
- 81-90 Snake
- 91-00 Wolf

#### NINE: Secret Base of Operations

- 1-10 None
- 11-25 Basement (home, apartment building, etc.)
- 26-45 Abandoned warehouse or building of any type.
- 46-55 Mausoleum in a graveyard.
- 56-65 The attic of a house.
- 66-71 A secluded spot in the woods (or park).
- 72-82 Legitimate business fronts for cult activity.



- 83-89 Sewers  
 90-00 Private estate.

### TEN: Criminal Record

- 1-30 None  
 31-40 A few misdemeanors.  
 41-50 None, but wanted for questioning about the disappearance of a couple of acquaintances.  
 51-74 Suspected on several felony charges, but no evidence to make the charges stick.  
 75-87 A few misdemeanors, 2D4 felonies. Time served.  
 88-00 Wanted fugitive for 1D6 felony counts.

### ELEVEN: Available Financial Reserves

- 1-13 1D6 × 10,000  
 14-26 2D6 × 10,000  
 27-38 3D6 × 10,000  
 39-50 4D6 × 10,000  
 51-63 6D6 × 10,000  
 64-75 1D6 × 100,000  
 76-87 2D4 × 100,000  
 88-00 3D6 × 100,000

### TWELVE: Age

- 1-15 23  
 16-30 28  
 31-45 30  
 46-65 35  
 66-85 40  
 86-00 46

## A TYPICAL FANATIC CULTIST

#### Alignment

- 1-40 Diabolic  
 41-80 Miscreant  
 81-00 Aberrant

**P.P.E.:** 3D4 + 10

**Hit Points:** 3D6 + 6

**S.D.C.:** 2D6 + 10

**Attributes:** Average

**Education Level:** High school or one year of college.  
 100% loyal to the cult leader and will die for him/her.

## RANDOM MONSTERS

The specific creatures described in the monster section are but a handful of supernatural beings that populate the multitude of dimensions and other worlds that coexist in the universe. The following tables are provided so that the game master can create other, random, unknown menaces. Future supplements will describe more legendary and mythical monstrosities. *The Palladium Book of Monsters & Animals*, although designed for the Palladium Fantasy RPG, also offers dozens of unique creatures that could be easily adapted to **Beyond the Supernatural**.

## RANDOM SUPERNATURAL CREATURE CREATION TABLES

### FIRST: Roll For Alignment

- 1-20 Anarchist  
 21-50 Miscreant  
 51-80 Diabolic  
 81-00 Aberrant

### SECOND: Hit Points and S.D.C.

- 1-10 20 Hit Points/10 S.D.C.  
 11-20 20 Hit Points/20 S.D.C.  
 21-30 25 Hit Points/40 S.D.C.  
 31-40 30 Hit Points/50 S.D.C.  
 41-50 35 Hit Points/70 S.D.C.  
 51-60 40 Hit Points/80 S.D.C.  
 61-70 60 Hit Points/100 S.D.C.  
 71-80 80 Hit Points/120 S.D.C.  
 81-90 100 Hit Points/150 S.D.C.  
 91-00 120 Hit Points/200 S.D.C.

### THIRD: Size

- 1-6 3ft tall/50lbs  
 7-13 4ft tall/65lbs  
 14-24 5ft tall/90lbs + 1D4 × 10lbs  
 25-35 6ft tall/120lbs + 2D4 × 10lbs  
 36-47 8ft tall/140lbs + 3D4 × 10lbs  
 48-57 10ft tall/180lbs + 3D4 × 10lbs  
 58-68 12ft tall/220lbs + 4D4 × 10lbs  
 69-78 15ft tall/300lbs + 4D4 × 10lbs  
 79-88 18ft tall/400lbs + 4D4 × 10lbs  
 89-00 20ft tall/500lbs + 4D4 × 10lbs

### FOURTH: Natural Abilities

- 1-8 Climb — 90%  
 9-15 Prowl — 90%  
 16-22 Turn Invisible  
 23-29 Fly — 50mph  
 30-36 Exceptional Strength; P.S. 20, +5 to damage.  
 37-45 Exceptional Physical Prowess; P.P. 20, +5 to dodge.  
 46-53 Impervious to Fire  
 54-60 Metamorphosis into a spider, scorpion or beetle.  
 61-67 Track by Smell — 85%  
 68-74 Fire Energy Bolts; 2 attacks per melee, range: 90ft, 2D6 damage.  
 75-81 Nightvision — 200ft (61m)  
 82-86 See the Invisible (same as spell)  
 87-94 Breathe Fire; one attack per melee, range: 20ft, damage: 3D6.  
 95-00 +2 to save vs magic

### FIFTH: Hand to Hand Combat

- 1-15 One attack per melee, +1 to strike, +2 to parry & dodge.  
 16-30 Two attacks per melee, +1 to strike, +3 to parry & dodge.  
 31-47 Two attacks per melee, +3 to strike, +4 to parry & dodge.  
 48-62 Three attacks per melee, +3 to strike, +3 to parry & dodge.  
 63-87 Four attacks per melee, +2 to strike, +2 to parry & dodge.



- 88-00** Five attacks per melee, +3 to strike, +5 to parry & dodge.  
**Note:** Damage from a punch or claw is 1D6 unless otherwise stated.

#### SIXTH: Special Powers

- 1-12 Magic and Psychic:** Select 5 spells and 2 rituals from levels 1-5, has 1D6 × 10 magic P.P.E.; purchase psychic abilities from either physical or sensitive categories (not both), has 2D6 P.P.E. to spend; has 1D6 × 10 I.S.P.
- 13-24 Magic Only:** Select 4D6 spells and 1D6 rituals from levels 1-8. Has 2D4 × 10 magic P.P.E.
- 25-40 Psychic (Physical only):** Has 3D6 P.P.E. to purchase psi-abilities; has 2D4 × 10 I.S.P.
- 41-54 Psychic (Sensitive only):** Has 3D6 P.P.E. to purchase psi-abilities; has 2D4 × 10 I.S.P.
- 55-60 Psychic (healer):** Has 4D6 P.P.E. to purchase psi-abilities, and has 2D4 × 10 I.S.P.
- 61-74 Psychic (physical):** Has 5D6 P.P.E. to purchase psi-abilities; has 3D4 × 10 I.S.P.
- 75-86 Psychic (both):** Has a total of 6D6 P.P.E. to purchase psi-abilities from both physical and sensitive psychic powers. Has 3D4 × 10 I.S.P.
- 87-00 High Magic:** Select 3D6 spells and 2D6 rituals from levels 6-10 (nothing lower). Has 4D4 × 10 magic P.P.E. points.

#### SEVENTH: Appearance

- 1-10 Humanoid: Canine** with large canine head (resembles werewolf), fangs, dog haunches, tail and fur. Bite does 2D4 damage, claws do 1D6.
- 11-20 Humanoid: Birdlike** with a hawk-like head, beak, feathers, and talons on hands and feet. No wings. Bite does 1D6 damage, claws do 2D6.
- 21-30 Humanoid: Lizard-like** with reptilian features, head, hands, feet, tail and scaly skin. Claws or bite does 2D6 damage.
- 31-40 Spider-thing.** Hideous, spiderlike body with eight legs; two spindly, humanoid arms and monstrous, humanoid head/face. Additional natural abilities include: Climbing — 90%, Prowl — 60%, Speed — 40 and +40 S.D.C. Claws do 2D4 damage.

- 41-50 Humanoid: Feline** with catlike head, fangs, retractable claws (which do 2D4 damage each hand), and tail. May or may not have fur. Bite does 2D6 damage. Claws do 2D4 damage.

- 51-60 Humanoid: Skeletal;** appears as a living skeleton or corpse with distorted human features. Claws/fists do 2D4 damage.

- 61-70 Tentacle-thing:** A blob with 4D4 tentacles and no other apparent features or appendages. Add two attacks per melee. Each tentacle does 1D6 + 2 damage, + 2 to parry and dodge.

- 71-77 Insect-thing:** Humanoid or bug-like with six appendages legs/arms, bristly hairs, hard (exo-skeleton) body shell, big multifaceted eyes, and antennae. Bite or stinger does 2D6 damage, claws do 1D6 (+ P.S. bonus). Physical strength (P.S.) is 18 + 1D6. S.D.C. bonus of 1D6 × 10. 50% can fly (40mph).

- 78-85 Energy Being:** No form; appears as a floating sphere of energy. Communications via telepathic transmission, and can fire energy bolts. Bolts have a 90ft range and inflict 3D6 damage.

- 86-95 Humanoid: Human:** A being that appears completely human, male or female.

- 96-00 Humanoid: Demonic;** resembles classic depiction of demons and devils. Usually red or brown-skinned, human features, powerful build, bat wings, tail and horns.

**Note:** These are some basic, perhaps, most common forms of other-dimensional creatures of magic. Feel free to modify and create your own: single eyed, elemental, winged, dragon-like, shapeless, invisible, and so on.

#### EIGHTH: Horror Factor

1-8	Six		
9-16	Seven		
17-24	Eight		
25-32	Nine		
33-40	Ten		
41-48	Eleven		
49-56	Twelve		
57-65	Thirteen		
		66-74	Fourteen
		75-82	Fifteen
		83-91	Sixteen
		92-00	Seventeen





## NINTH: Intelligence Level

- 1-30** Fair I.Q. (about 6 or 7), secondary type skills are possible; predator. Select 8 secondary skills.
- 31-50** Low I.Q. (about 4 or 5), skills are impossible; predator/hunter. More animal-like than human, but can understand simple aspects of human civilization, recognizing uniforms, weapons, light switches, etc.
- 51-70** Low I.Q., total animal instincts. A natural predator, quick, cunning, and deadly.
- 71-90** Medium/average I.Q. (about 9), can learn skills and easily adapts to human civilization. Select one skill program and 6 secondary skills.
- 91-00** High I.Q. (14 or higher), works easily within the human society, can learn human skills, educated. Select two human skill programs and 6 secondary skills.

## POSSESSION

Entities and greater supernatural beings, such as "intelligences," can possess people or animals. These are always malignant, evil forces which crave to hurt or toy with humans. The foul creatures are actually able to transfer all or part of their evil life-essence into another living being and *completely* dominate it. The possessing force is so strong that it can suppress the victim's own consciousness and control the body like a diabolical puppetmaster.

### The Act of Possession

A supernatural being is only capable of possessing another living creature when it is in energy form or a psychic energy extension of itself is made. Creatures with the ability to possess can try to do so as often as twice per day (24 hour period).

A *possession attempt* is an instantaneous battle of wills. Like all combat in the Palladium system, a 20-sided die is rolled by the possessing entity. This is the attack and the attacker. The defender, who is the intended victim, gets to roll for a mental block or parry. Again, a 20-sided die is rolled. The high roll win, the low roll loses, defenders always wins ties. Most of the characters will have a bonus to save vs possession, giving them an edge in defending against the mental onslaught.

If the defender's roll (plus bonuses to save vs possession) is lower than the attacker's, roll the character has failed to defend against the possession attack and is immediately possessed.

A **successful possession** means the creature has inhabited the body of the person (or animal) and completely dominates that body. The essence and intellect of the original person is completely submerged, dormant, as if asleep, and will have no idea nor memory of what the possessing creature is doing with his/her body. The foul thing can commit murder or worse, and the person is totally oblivious to what is happening. A favorite ploy of many possessing intelligences is to play schizophrenia with the person. This is done as much to unnerve and torment friends and associates as the possessed person. What the creature does is let the person seemingly have control of his/her body and then, at the right moment, seize control and do something completely out of character (usually insulting, violent or depraved). Then let the person back into control to suffer the consequences of something he has no recollection of committing, even if there are a dozen witnesses. Unlike the victim of the possession, the creature is completely aware of everything that person experiences.

### Conditions and Restrictions for Possession

1. The possessing force must be an energy being or produce a psychic energy creature as an extension of itself (*see intelligences*).

2. The creature can never possess somebody in the same dimension that its physical body exists in. This specifically refers to supernatural intelligences who can split into two separate entities, one energy and one of flesh and blood. The energy-self can be sent to another dimension where it can possess a person or an animal, but if the physical body should enter into our dimension the possessing force would be immediately extracted to join its physical self. With both the physical and energy portions of the thing in the same dimension, it can no longer possess anybody.

While this may sound like good news for the person who is now free of possession, it is really bad news. Why? Because the physical being is several times more powerful.

3. Entities and intelligences can never possess more than one living creature at a time. Note that the willing transformation from human to vampire is an entirely unique form of a possession-like process, but is more like a metamorphosis.

4. The possessing being can relinquish its hold over the person to let the individual seem to regain control without actually surrendering the host body. During these quiet moments, the being simply sits back and observes. It can reassert its control instantly, whenever it desires to do so.

5. The possessing force can willingly leave the host body whenever it so pleases, departing effortlessly and without inflicting damage. However, the being must find a new host body within 24 hours or it will be inexorably drawn back to its own dimension.

6. The act of possession is instant and completely unknown/invisible to everyone except the intended victim.

7. If the evil force fails its attempt to possess, it only gets a second try. It may choose to try again on the same person or look to another target. A second failed attempt within a 24 hour period may cause shock and hurl the being back into its own dimension. It can only attempt a possession two times per 24 hours.

Two consecutive failures to possess will have the following results. Roll percentile dice.

1-50 The being is instantly returned to its own dimension.  
51-00 The being is shaken, but can exist without a host body for another 24 hours. At the end of that period the creature must try again. Repeat this cycle until the being makes a successful possession or is returned to its own world.

8. A possessed host body can be dominated by the alien force immediately.

9. The entity or energy intelligence can use all of the powers and knowledge it may have while in the host body (*see demon familiar*).

10. The battle of wills and saving against possession occurs only once, at the very moment of the attack. Once an individual is possessed, he remains so until the possessing force leaves or is removed.

11. Possession should not be confused with magic enchantments, like domination, trance or compulsion, hypnotic sugges-



tions or psychic mind control. The difference is that an alien life-force has actually *inhabited* the person's body and taken complete control.

12. Although the entity or intelligence is aware of everything the person experiences, it does not know what that person is thinking, nor does it gain the person's past memories or skills.

13. Victims of possession are rarely willing hosts. But if the person willingly allows himself to be possessed, there is no battle of wills and the act of possession is an automatic success.

14. The experience of being possessed is a terrible one. Although the victim rarely remembers any of the things the creature may have done, the experience is traumatic. Roll on the Phobia Insanity Table if possessed for more than a month. Roll on the Obsession Table and on the Phobia Table if possessed for over

six months. Roll on the Random Insanity Table if possessed for over one year.

**Getting rid of a possessing force** is extremely difficult. Magically, only exorcism has any chance of success. Banishment, control or summon beings, and all the rest, are ineffective. Of course, one can always try to talk the damned thing out, but that seldom works. Psychic powers can be used to attack the entity itself, but will definitely provoke the creature to violence. A psychic healer can also use his form of exorcism against the possessing entity. The incapacitation of the host body through drugs or magic for long durations (1D6 months) may entice the entity to leave in search of a more fun body. Killing the host body will always set the entity free, but doesn't do much good for the victim.

# GAME MASTER'S SECTION

## A DIFFERENT LOOK AT THE HORROR GENRE.

**Alternative, outrageous, silly, but always fun horror genre rules.**

**Or**

**Dad, don't go in the basement!**

*By Erick Wujcik*

In this section, Erick Wujcik takes a look at the classic movie/comic book genre of horror. The wonderful recreation of every grade C horror-victim story ever made. You know the ones, a carefree suburban family moves into their new Victorian house only some "thing" lives in the basement and it's hungry. Or the neighbors are really vampires or . . . well, read on.

## ROLE-PLAYING THE VICTIM CHARACTER

Most role-playing games are based on hero oriented fiction. With an accent on the word *hero*. Players' characters are somehow larger than life in the fashion of heroic fantasy characters.

This kind of character is great in a long running campaign, but sometimes it's interesting to play somebody normal, somebody unexciting, somebody mundane. And, from the Game Master's point of view; somebody helpless.

Consider movies; not just horror movies, but movies in general. For some reason, we tend to be more involved when watching average folks terrorized by forces far beyond their control. Sure, we worry about the bigger-than-life hero, but we already know he's not really going to lose out to the slobbering monster. There will be plenty of hapless victims wiped out, but the hero will definitely survive.

On the other hand, when the movie stars a cast of victims, we don't *know* that any of them are going to survive. Any one of the helpless family, or the screaming co-eds, can fall victim to mysterious forces.

Whole movie studios, including the best directors in the business have built entire careers on showing typical small town or suburban people being scared to death.

And it can be just as much fun for the players of a role\*playing game. Now if you, the Game Master, can just talk your players into trying it...

**PLAYER:** Hey Mr. Game Master! Why do I want to play some dummy that's gonna' get swallowed by a monster?

**GAME MASTER:** Because it'll be fun! Let me ask you a question, do you like watching horror films?

**PLAYER:** Yeah, so what?

**GAME MASTER:** So usually you see pretty normal people most horror films. And in most horror books, and comics. You know why they use normal people instead of super-duper heroes or experts?

**PLAYER:** Hmm...

**GAME MASTER:** It's because it would be boring to watch real hot-shots killing monsters. With normal people it's a lot more exciting.

**PLAYER:** Why?

**GAME MASTER:** It's the suspense. When you watch the movie you know that somebody can get creamed. You know that the monsters could wipe out everybody. And you're not sure if the normal people can defeat the monsters, sometimes they do and sometimes they don't.

**PLAYER:** So why should I want to play a normal person?

**GAME MASTER:** Same reason. Playing your average bimbo human being you don't know what's going to happen. You could get eaten in the first five minutes, or you could figure out how to electrocute the sucker and save the day. Anyway, this way I get to throw some really nasty, hideous and monstrous stuff into the game.

**PLAYER:** And I still have a chance?

**GAME MASTER:** (chuckles evilly) Sure you do... After all, how much fun would it be if you died before the really nasty stuff showed up?



**PLAYER:** But can normal people beat nasty supernatural monsters?

**GAME MASTER:** Sure! Remember, this adventure is designed especially for characters with no special abilities. And just think, when you beat the monster, you'll be doing it with pure skill and brains.

### GENERATING THE VICTIM O.C.C.

All victim characters are normal, unskilled, non-talented, non-psycho people. Victim characters have no knowledge or skill in any arcane art. They are victims first, last and always.

More important than any skills, powers or attributes is the player's ability to stay a victim in character. So the most important thing about Victims is the role they're going to play in the game. Here are the possibilities:

**1. All player characters are part of a family group.** Player characters will take the parts of the *mother, father, grandparents, aunts, uncles and children of all ages*. Which player gets which role depends either on everybody in the group choosing the character they want, by roll of the dice, or by assignment by the game master. Generally, in this kind of game the GM will let the players know which roles ought to be held by player characters. The amount of dice rolled for different attributes will depend on the character's age.

**2. All player characters are part of a social group.** This could be anything from a group of Brownies to a company bowling league. All the players are roughly the same age, and all the characters attributes are rolled on the same dice.

**3. All the player characters can be based on other fictional characters.** A great way to set up a victim group is by giving them each characters from a well known television show. For example, in groups based on T.V. shows, each player could be one of a group of taxicab drivers from a comedy show, or a group of police from a dramatic show. All the members of any number of family based television shows would make a good group as well.

### ROLLING UP CHARACTER AGE – OPTIONAL

01-17 Child: Roll 1D6+3 for age

18-40 Pre-Teen: Roll 1D6+6 for age.

41-65 Teenager: Roll 1D6+12 for age.

66-85 Young Adult: Roll 2D6+18 for age.

86-95 Middle-Aged Adult: Roll 3D6+30 for age.

96-00 Senior Citizen: Roll 4D6+51 for age.

### ATTRIBUTE ROLL-UP TABLE

	<i>Infant</i>	<i>Toddler</i>	<i>Child</i>	<i>Pre-Teen</i>	<i>Teenager</i>	<i>Adult</i>	<i>Senior</i>
I.Q.	1	2	1D6	2D6	2D6	2D6	2D6
M.E.	1	2	1D6	1D6	2D6	2D6	2D6
M.A.	1	2	2D6	2D6	2D6	2D6	2D6
P.S.	0	1	1D6	1D6	2D6	2D6	2D6
P.P.	0	2	2D6	2D6	2D6	2D6	2D6
P.E.	0	1	1D6	1D6	1D6	2D6	1D6
P.B.	2D6	2D6	2D6	2D6	2D6	2D6	2D6
Spd.	0	1	1D6	2D6	3D6	2D6	1D6
P.P.E.	4D6	4D6	3D6	2D6	1D6	1D6	1D6
S.D.C.	2	4	6	8	10	12	8

**NOTE:** Infants and Toddlers are not allowed as player characters. However, because they are valuable NPCs, their roll-ups are included on the table.

**EXAMPLE:** Harold has been volunteered to play one of the children of the player group family. He ends up with a teenage boy. Rolling to see how old he is (above), he rolls a 3, adds it to 12, and arrives at 15 for his age. For Spd. he rolls 3D6, then 2D6 for I.Q., M.E., M.A., P.S., P.P., and P.B., then 1D6 for P.E. His character's P.P.E. will be determined with another 1D6, and his S.D.C. is predetermined; 10 points.

### GUIDELINES FOR VICTIM CHARACTER'S ATTRIBUTES

Most of the Victim player character's attributes are rolled on 2D6 regardless of age (remember, infants and toddlers are not player characters). This means they're going to be wimps compared to the usual kind of player character found in most Palladium Books' games. Still, there's a good range here for comparison between characters. The following discussion of relative I.Q. can be applied to any of the Attributes.

I.Q. of less than 5 means the character has a lot of problems in school and in the real world.

I.Q. of 5, 6 or 7 means the character is slightly slower than average, and has to work or study harder to keep up with everyone else.

I.Q. of 8, 9 or 10 means the character is pretty much normal. School is difficult but not demanding, and everyday problems are relatively easy to solve.

I.Q. of 11 or higher means the character is pretty brainy, school is boring, and solving crossword puzzles and math problems is easy. The character will not necessarily end up a success, but he'll easily solve any intellectual problems that show up.

Another way to use the characters' various attribute scores is to compare them with each other. For example, the character with the highest M.A. in the group will tend to be the most popular, and the one with the lowest M.A. will be the least popular.

Incidentally, don't neglect the P.B. (Physical Beauty) score in a Victim game. Fact is, in real life, a person's physical attractiveness has a far greater importance than in most role-playing scenarios.

### ALIGNMENTS

Victim characters don't have the usual sort of alignments. That's because most normal people don't live in a "kill or be killed" kind of world. So the victim characters tend to have rather wimpy outlooks compared to more heroic characters.

Being *good* rarely involves much more than donating time or money to a charity and being nice to your neighbors. Selfish characters aren't the thieves of the world, they're just self-centered and egotistical. And real *evil* is rare. The worst we encounter in daily life are people who are insensitive and cruel in aggravating and petty ways.

So, since most victim characters tend to be "chumps," here's a watered down version of the Alignment system for victim characters:

### NICE CHARACTERS

**Chump:** The push overs of the world. Innocent, gullible and dumb. Fortunately, most people are basically chumps. They believe in right and wrong, and in doing the right thing for others. Once any initial panic is past, a chump will even risk life and limb to protect others.



**Self-Righteous:** Ranges from the grandmother who is constantly giving lectures on “doing the right thing” to the little snitch who’s always running to “Tell Mom what you did.” Although self-righteous characters can be courageous, they’ll always try to get someone else to do the real work.

### SELFISH CHARACTER

**Self-Centered:** It’s not that they want to hurt anyone, they just don’t notice anybody but themselves. Their favorite topic of conversation is themselves. They will make all decisions based on what’s best for good old number one.

**Piggy:** This character has never really grown out of his toddler-level, “I Want!” stage of emotional development. Material possessions are all-important, and the character will easily rationalize any minor misdeeds (small lies, deceptions) that help him get what he wants. The character is easily tempted, especially when offered lavish rewards. Occasionally they’ll even risk their own life for something, but just temporarily.

### NASTY CHARACTERS

**Practical Joker:** The character delights in rather crude humor. They don’t mean to actually hurt anyone, but hiding a blind person’s cane is something they’d find pretty funny. Also whoopie cushions, hand buzzers, and putting salt into a sugar bowl. Very insensitive to the feelings of others and unwilling to help, even when asked.

**Bully:** This is the kind of character who will take advantage of any strength and use it to lord over others. Not necessarily physical strength, there are bullies who use their tongues, their social position, or simply money and power. They seem to feel that others are around only to be used. Self-preservation is very important to the bully.

### MONEY

Another major element in developing the Victim character is figuring out where their money comes from. The following table is used to determine the character’s financial status. Note that there should be only *one roll if the victim characters are all part of the same family*. If there are drastically different wealth levels in the same group there’s a good chance that the rich characters will be constantly plagued with demands from the rest of the player characters.

#### FINANCIAL BACKGROUND (Roll Percentile)

**01-20 Poverty:** The family lives on welfare, occasional part-time jobs, and handouts from other, more well-to-do, relatives.

**21-65 Wage Slavery:** Bound by debts, mortgages and credit card bills, the family makes too little money to ever break even. Every month the total owed gets larger and the amount of available cash gets smaller. The family is living beyond their means and is trying to keep up appearances.

**66-95 Yuppie Heaven:** All the adults of the family work at high paying professional jobs. There’s enough money to go around, the shortage is in time. High-powered jobs require lots of overtime, traveling and job-related socializing. As a result the family members are pretty much strangers to each other.

**96-00 Wealthy:** So much money that mere possessions no longer mean much. Every family member has just about anything

they would like. Also implies a lot of feuding over the family fortune along with involvement in politics and high finance.

### SKILLS

Generally, Victim characters are unskilled. Hmmm. Actually, that’s not quite true. Victims are often skilled, either in their professions and/or in their hobbies. It might be more accurate to say that Victims generally don’t have any skills that are useful in battling the supernatural.

Where a heroic character might have a dozen practical skills, most Victims would only have one, or none. And that one skill should reflect the career level of the character. Look at the medical category. **For Example:** A character who lives in poverty might take First Aid. Wage slaves can have Paramedic or Nurse. Yuppies could definitely *be* doctors. The wealthy, of course, can choose to do anything they’d like.

Each adult character gets to pick *one major skill*. It can be either an academic skill, that reflects the character’s job, or a skill related to the character’s leisure pastime. In addition, most adults will have *three Secondary Skills*, but they must be related to the character’s daily life. Examples of appropriate Secondary Skills for Victims are Driving, Cooking, and Sports Appreciation.

Kid characters don’t need any skills. If the player insists on some skills, then point them in the direction of hobbies that would be typical for their age group. Examples might be Collecting (comics, stamps, coins, etc.), Sports (little league baseball, touch football, etc.), Games (chess, RPGs, etc...), or Amateur Science (astronomy, geology, zoology, etc...). Older, teenage kids might know something about ham radio, electronic musical instruments, or body building (+2 to P.S.).

#### Here’s some examples of typical Victim skills:

**Home Computer Use:** A knowledge of how computers work, along with the skills to operate peripherals like keyboards, printers and modems. Victim characters can follow computer directions, use prepackaged programs and games, but any sophisticated operations or computer programming is beyond them. **Base Skill:** 35%.

**Cook:** Usually, at least one person in each family group is skilled in cooking. Not as a gourmet, just in the basics of making three square meals a day. Failing a roll means that some or all of the cooked food is either inedible (burnt!) or distasteful. **Base Skill:** 50%.

**Fishing:** Methods and enjoyment of the relaxing sport of fishing. Areas of knowledge include the use of lures, baits, poles, line, and the cleaning and preparation of fish for eating. Note that oriental fishing in some areas involves using a spear or a hand-held net. **Base Skill:** 50%.

**Sewing:** The practiced skill with the needle and thread, to mend, layout, cut and sew simple patterns, and do minor alterations. **Base Skill:** 40%.

**Sports Knowledge:** This is the skill of a dedicated television sports fan. Includes a working knowledge of any three spectator sports such as Baseball, Basketball, Football, Hockey, Golf, Soccer or Tennis. **Base Skill:** 60%.

**Basic Electronics:** Rudimentary understanding of the principles of electricity, simple circuits, wiring, and so on. This person can do basic wiring, attempt to repair appliances and read schematics. **Base Skill:** 34%.



**Basic Automobile Mechanics:** The ability to fix cars. This person can repair simple problems, especially in the few models they're familiar with. **Base Skill:** 30%.

**First Aid:** Rudimentary medical treatment which includes how to bandage wounds, stop bleeding, administer CPR/artificial respiration, and use antiseptics, and common anti-inflammatory drugs and painkillers. **Base Skill:** 40%.

**Pilot Automobile:** The ability to operate a car, station wagon, or van. 90% + 3% per level for Automatic Transmission. **Base Skill:** 40%.

**Motorcycle:** In addition to being able to pilot dirt bikes (cross-country motorcycles) and street bikes (heavier highway motorcycles), the character also has a DODGE bonus of +2. **Base Skill:** 40%.

**Photography:** Taking black and white or color, still pictures. Characters will know how to load, develop and enlarge film. **Base Skill:** 50% + 5% per level of experience.

**Secondary Skill Level:** -10% Base Proficiency.

## EXPERIENCE AND EQUIPMENT

*Unnecessary.*

As to Experience, Victim characters should pretty much end the adventure unchanged, but with a greater appreciation for strange phenomena.

Of course, it is possible to carry on a campaign with Victim characters. In that case, one of two things can happen. Either the campaign will still require helpless victim characters, in which case the player characters should remain unchanged. Or the campaign can move into realms requiring more conventional characters, and, if so, the characters should be allowed to select and change into one of the standard P.C.C.s.

Equipment is also unnecessary, since all the usual resources of modern man, at work or play, are already available. The equipment will simply be what you'd expect to find on the site of the adventure. If they find a supernatural event in their own house, then they can use any items you might expect to find in the house. On a camping trip, a goodly amount of camping equipment is available.

On the other hand, if the player characters just wander into something in the course of their normal lives, they'll be limited to the contents of their pockets and purses. Any reasonable items should be permitted by the game master. If there's a dispute, you can always demand that the players empty their own pockets and purses, and let their characters have anything they come up with.

## VICTIMS: A GUIDE FOR GAME MASTERS

"Hey, I'm not going down in that deep, dark basement with nuthin' but the stub of a candle and a baseball bat! I'd have to be stupid or sumthin' — especially considering that fifteen people already went down and none of 'em have come back yet."

A lot of players will have a little trouble figuring out the main idea behind the "victim" style of role-playing. You can usually identify the troublemakers when they start asking for the kinds of things that are usually useful in conventional role-playing games. The guy who wants a gun, or lock picking ability, or computer hacking skills, is having trouble getting into the proper spirit of the game.

Don't try reasoning with 'em. One solution is to give the character anything that the player asks for, 'cause it's not going to help anyway.

It's also a good idea to pull a few "equalizing" tricks out of your game master hat. Players who are trying to be "heroes" in a Victim game will usually try to be older characters, or, at least, teenagers. These characters can easily be hampered by certain social stigmas, with a place firmly on the bottom of the group's pecking order. For example, the "father" can be given a dead end job, with low status, and be portrayed as a bumbling boob, loved by younger kids, scorned by the adolescents and pushed around by his wife. And teenagers... well, a teenager's potential problems are limitless.

It's also a neat idea to throw victim characters against outrageously difficult monsters and situations. The threat can be far greater than would be allowable in a conventional role-playing game where the characters should be given a fighting chance of victory.

As a game master, it's your job to keep things relatively fair. Here's two ways to keep it fair:

1. Make sure there *are* solutions to the problems in the scenario. For example, if the horrible, icky monster won't pursue anyone into the kitchen, it's possible for the players to figure out that the thing dissolves under attack from dishwasher detergent or oven cleaner. Likewise, the "Great Amulet", or some other gimmick, is available to master the situation.
2. Let the players generate new characters quickly. If you're planning on running the Victim game as a bloodbath, you've got to avoid boring the guys who get bumped off early. A good way to do this is by assigning more player character roles. For example, once Eddie is devoured by the washing-machine-monster, the player gets to play snoopy Mrs. Vincent from next door.

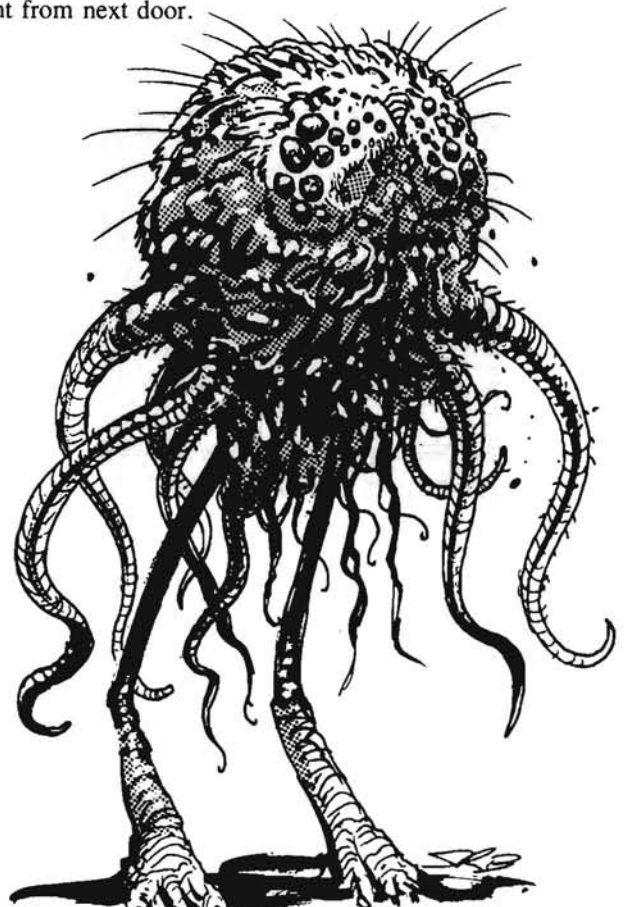



# A GAME MASTER'S GUIDE TO BEYOND THE SUPERNATURAL

By Erick Wujcik

First, let me tell you what this section is **not**. It's not an introduction to the art and practice of game mastering.

If you aren't an experienced game master, then I suggest you learn the skills of running a role-playing game. How? There are three great ways. First, you play some role-playing games. While you play, pay attention to what works, what makes you excited, what's fun, and what makes you want to keep playing the game.

Second, watch game masters run games. Figure out how they run their games. And figure out what they do that works, and what doesn't work.

Finally, read the rules of various role-playing games. Every game has some elements of technique and style that a game master can profitably adapt. For example, study the "read the following" paragraphs included with the adventures in this book. If you do read them out loud, you'll find that they each communicate several things. A mood, a suggestion of possible actions, and a style of describing what the senses can perceive without revealing everything.

Remember, this is not an introductory role-playing game. **Robotech** and **Teenage Mutant Ninja Turtles and Other Strangeness**, both from Palladium Books, are great *beginner* games. For what follows we expect a certain amount of experience and judgement from the game master.

So, if this section isn't an introduction to game mastering, just what is it? It's a set of tips and techniques for improving the climate of *horror* in any role-playing game.

## The Rules of Horror and the Art of Role-Playing

What is the point of a horror story? It's basically a teaching tale. Among our distant ancestors, the elders would sit around the campfire and tell tales. Usually they used common elements, like a frightening monster that threatened to kill everyone. Defeating the monster required brains, or skill, or bravery. And there were always two possible outcomes: either the hero won or the monster won. Either way, the idea was to scare the young snots into listening to the lessons of the elders.

The same methods required for scaring little kids around campfires are still being used today. They're also the same techniques being used by authors of contemporary horror books and movies. And they're the same rules that *you* can use in running horror role-playing.

### 1. Describe instead of Tell.

There's nothing worse than telling a player, "You are scared." Most players are tempted to just reply, "No I'm not!"

Trying to *force* a player to feel a particular emotion is useless. The only way to get a player to feel anything is by playing on their imagination. If the player visualizes something horrible, there's a good chance that fear will follow.

Describing the source of the fear ("The ghostly form is moving quickly toward you.") is always better than simply describing the fear itself.

Consider the following, "You are cautiously walking down the stairs. As you point the flashlight down into the basement, you can see that there is something moving. In fact, the whole floor seems to be writhing with tiny blinking eyeballs."

### 2. Imply rather than Tell.

"You're slipping. The gravel is giving way beneath your feet. The only thing you can grab onto is the door knob by your hand. And you notice it is an odd green color. What are you doing?"

By rights, the player should grab the knob. The only other choice is to fall into the unknown. Yet the player hesitates, torn between two fears.

An "odd green color." What could it be? Is that just discoloration from age and decay? Or a trap made of some vile acid? Or a little harmless mold? Or the slime of an evil entity waiting to possess a new victim?

The GM hasn't actually said there is anything wrong with the door's knob. It was merely implied that there might be something amiss.

Another great tool of intimidation is that of questioning the players about seemingly innocent actions. A simple question like, "You're reaching out into the darkness with your left hand . . . or your right?" can really raise the tension in any scene. The player's imagination starts working overtime once again, thinking of what possible difference the hand could make. Involuntarily, the player must envision the possibilities of the hand being chopped off, bitten, trapped, and so forth.

### 3. Keep the Suspense of the Unknown.

What is known is not frightening. It may be challenging, but it can't be really scary. It's the unknown that holds the real promise of fear.

For example, if you tell a player, "The monster is hiding in the far corner of the shed" you've made it far too easy. "You hear one drip of liquid, then another, coming from the far corner of the shed," is setting up the player for a myriad of possibilities.

This rule extends to many things. Don't tell the characters what monster they are facing, let them figure it out. And when they do figure it out, don't bother congratulating them. After all, as long as the GM keeps silent, they don't really know what they're up against. Which adds just another touch of suspense to the game.

### 4. Use All the Senses.

There are six ways to scare a character. They're called: **Seeing, Hearing, Smelling, Tasting, Touching, and Sensing**. Remember, players will only feel horror, fear or suspense, if they *imagine* something about the thing that causes it.

Unfortunately, after too many experiences of a particular kind, fear changes to boredom. That's where the other senses come in. Even if a player has imagined *seeing* a monster a dozen times, offering the imaginary smell of the creature, can still be



a vivid enough sensation to cause tension to rise. Likewise, the player character may have killed a hundred slimy things, but when the *feel* of one on the back of his neck is described, the fear will come back as a fresh experience.

### 5. Build the Suspense with Forewarning.

Often, especially after a campaign has been running for awhile, the players can get jaded (“Oh, another giant spirit destroyer, I wonder what’s for lunch today?”). One way of dealing with that is to give the players hints that the latest threat is somewhat more than ordinary.

One possibility is to provide consistent clues. Witnesses can report the same sensation. If they hear from the farmer, “Yup, it always started with that danged high pitched whistle. Then, sure as shootin’ one of the cows would burst open with blood spraying everywhere.” You can bet they’ll be a little nervous when the GM describes anything like a whistle.

## Beyond the Rules of Beyond the Supernatural

The terrors of a horror role-playing game must go beyond the ordinary. Beyond the terrors of real life. Beyond the terror of failing a test, missing the bus, or even being shot at by some crazies.

We’re talking of real terror here. The terror that people can only feel when the natural laws, those comfortable boundaries of existence, start to crumble.

Take, as an example, a run-in with the neighbor’s dog. You walk by the neighbor’s fence every day. And, every day, that stupid Doberman barks and leaps and goes completely nuts. The first few times it happened you were alarmed. Now it’s just routine. You walk past, the dog does its little aggression number, and nothing changes. Until today:

**1. Fear.** You walk past the neighbor’s fence. You hear the dog growling and yapping and tugging at its chain. Then you hear something different; a sound, a “sproing,” that can only be the sound of the dog’s chain breaking. Your heart pounds, you feel fear . . . Right up until the dog bounces off the fence. Relieved, you continue on your way.

**2. Panic.** Just like fear. Same fence, same dog, same chain breaking, same sense of fear. And then you notice that some fool has left the gate open to the yard! No quick relief this time! Now you feel fear and you have to take action. You run to your car with the dog rapidly gaining on you. You feel panic . . . Right up until you slam the car door behind you and the dog bounces off the windshield. Relieved, you continue on your way.

**3. Terror.** Just like fear and panic. Same fence, same dog, same fear, same chase. The dog, scratching at the window, suddenly stops and stares at you. A blue glow seems to come from his eyes, and tiny cracks start to appear in the windshield. Even after you escape, the sheer horror doesn’t leave you. Something unnatural was out to get you.

## Horror in the Game Master’s Voice: An Example

Here’s a simple example of how the element of horror can be improved. In two cases, “A” and “B”, exactly the same events are described by the GM. As you read through the first one, try to figure out how the GM’s technique might be improved.

### INTERCHANGE “A”

A1. GM: “There are noises coming from behind the third door. What are you doing?”

GEORGE: “I’ll listen at the third door.”

A2. GM: “From behind the door there’s the sounds of a struggle. It sounds like claws ripping into flesh. That’s followed by a really hideous scream. Someone falls down.”

GEORGE: “I’ll kick open the door.”

A3. GM: “The door opens and you see a dead man with his guts hanging out. Something hairy is jumping out of the window.”

### INTERCHANGE “B”

B1. GM: “You hear noises coming from somewhere, perhaps from the third door. Are you getting any closer?”

GEORGE: “I’ll listen at the third door.”

B2. GM: “Nothing. The sounds have suddenly stopped. You see a pool of blood spreading out from under the door.”

GEORGE: “I’ll kick open the door.”

B3. GM: “The door gives way to your foot and you smell something totally new to you. A quick glance tells you the odor belongs to the human organs usually sealed inside a body, the body of the corpse at your feet. You’re hit by a blast of frigid air coming through the shattered glass of the room’s only window.”

The first statement, reporting the noises, is changed in two ways. In “A1” the noises are definitely coming from the third door. There’s nothing wrong with that, but it is too specific. Using the word “perhaps,” gives the player an element of doubt.

The second change, from “What are you doing?” to “Are you getting any closer?” is more important. Simply asking what a character is doing is relatively neutral. Asking “Are you getting closer,” is *much* more threatening. It implies that there is danger, that there is something to be afraid of. And it makes the player unsure. All of which adds to the element of horror.

The GM’s second statement is designed to give the player a clue that something terrible is happening behind the door. In the case of “A” we hear, “From behind the door there’s the sounds of a struggle. It sounds like claws ripping into flesh. That’s followed by a really hideous scream. Someone falls down.” There are a lot of things wrong here. Mostly because the GM is telling the player what is happening behind the door. But does anyone know what the “sound of claws ripping into flesh” sounds like? Or, can anyone know, just from the sound, that someone falls down? The game master is trying to force the terror.

Alternative “B” is much more subtle, because it lets the player’s make up their own terror. Read it again, “Nothing. The sounds have suddenly stopped. And you see a pool of blood spreading out from under the door.” It leaves the details of the events up to the players.

Again, the third GM explanation is meant to convey the sense of the horror. Basically, the players need to be told about the dead body. The first statement, “The door opens and you see a dead man with his guts hanging out,” is way too graphic. Most players will succeed in making that picture sterile and unemotional. After all, most experienced role-players have already come across thousands of imaginary bodies.



Avoiding the player's basic immunity to shock is easy if you approach things from a different point of view. ". . . you smell something totally new to you," forces the players to use their imagination, to imagine the smell of "human organs usually sealed inside a body." An imaginary *smell* is much more difficult to block out than an imaginary *sight*.

Finally, the GM has to draw the players' attention to the window. "Something hairy is jumping out of the window," is okay, but it fails to leave anything open to question. ". . . frigid air coming through the shattered glass," implies that someone or something left that way, but it doesn't actually say so. Once more, the terror of the situation is increased because the players don't *know* where or what the creature is.

### What To Do When The Players Start Thinking Logically

One last thing about GMing a horror game. There will come the time when the players want to do the right thing. Something along the line of:

"What! You expect me to walk down into that dark basement? Armed with nothin' but a candle stub and a baseball bat? After six guys already went down and nobody came back up? No way! It's not my job. I'm calling the cops. Let them go down there!"

There are plenty of ways that the players can wreck a perfectly fine scenario for **Beyond the Supernatural**. Most of them involve doing the kind of rational, logical things that any intelligent citizen would do. So, as a reasonable game master you've got to find a reason why they *can't* act like intelligent citizens. Consider some of the following:

1. **Don't Believe Them.** Often the first thing the players will do is attempt to call in outside help; usually the police, a military organization, or a scientific research facility. One way of dealing with this problem is to ridicule the caller. Remember that the average police desk sergeant is not likely to be real sympathetic with some loony.
2. **Swallow the Evidence.** Let's say the group actually manages to get some kind of help. Either by lying (yelling FIRE! instead of GHOST! is often effective) or by fast talking, they manage to bring in the local authorities. Just have the "help" get swallowed up by the monsters. Or the monsters are not there when help arrives (only to have a subterranean escape tunnel discovered by the player characters after the disgruntled help leaves). This will definitely discourage them from calling outsiders in the future.
3. **Arrest Them.** Most police forces, not to mention prosecuting attorneys, are tremendously overworked. They often arrest the first available suspects in a crime, *especially* if there's a lot of media attention. The guy running around and pointing the finger at supernatural causes makes a great suspect, and as long as the suspect is undergoing "psychiatric analysis" (a stay in a state mental institution with regular therapy sessions, straightjackets and rubber rooms optional), the pressure to find the actual criminal is off.
4. **Hide The Evidence.** Isn't it weird how them psychic phenomena just come and go at the drop of a hat? It's sort of like when the player characters are all alone the creepy crawlies just burst out of everywhere. Then, when the cops finally take them seriously and show up to investigate, *poof!*; there's nothing there. And, wouldn't you know it, fifteen

minutes after the angry cops have left, the monster shows up again. Isn't it just too weird?

5. **How Come Everybody Else Looks Funny?** Through blatant acts or by subtle clues, imply that the authorities are actually controlled by some kind of evil force. One application of this is to respond to the player characters call for help by sending in some of their enemies.

## GUIDELINES FOR SCENARIO CONSTRUCTION

Here are a few tables helpful for constructing scenarios. Putting a scenario together for **Beyond the Supernatural** can be pretty simple. Just follow these steps:

### STEP 1:

Pick out the background problem for the adventure. Some possibilities include a monster, a natural phenomenon, a mystical artifact or a P.C.C.type villain. If necessary, use the following table to determine the origin of the paranormal phenomena:

### SOURCE

Long as it is, this is far from an exhaustive list. A little library research will unearth hundreds of other possible sources for supernatural artifacts and adventures.

1-10	Egyptian
11-15	Norse
16-20	Celtic
21-25	Ancient Greek
26-30	Ancient Roman
31-35	Polynesian
36-40	Caribbean (Voodoo)
41-45	African
46-55	Native North American Indian
56-60	Aztec (Mexico and Central America)
61-65	Inca or Mayan (South American)
66-70	Japanese
71-80	Chinese
81-90	Tibetan
91-95	Ancient Hindu (Indian)
96-99	Stone Age (Paleolithic or Neolithic)
100	ExtraTerrestrial (NonHuman Alien)

### STEP 2

Insert the supernatural problem in a modern setting. It can be anywhere in the world, with any NPCs that seem appropriate. What follows are some of the possibilities for settings in North America.

### LOCATION

Here are some of the possible sites for a supernatural scenario.

1-05	Remote Wilderness
6-10	Federal, State or Local Park
11-15	Unchanged Rural Land
16-20	Rural Pasture Land (Cattle Country)
21-25	Rural Farmland
26-30	Isolated Ranch
31-35	Isolated Cabin
36-40	Isolated Farmhouse
41-50	Small Town
51-70	Suburb



- 71-75 Old fashioned, Ethnic City Neighborhood
- 76-80 Inner City Slum
- 81-90 Prosperous Urban Condominium and Shopping Area
- 91-99 Urban Downtown Business and Apartment Area
- 100 Ultra-Modern Planned Community

Just as an example, here are some of the possible sites for a scenario using a Small Town setting:

- 1-10 Empty Field. Formerly:
  - 01-20 Always Vacant
  - 21-40 Prehistoric Site
  - 41-70 Ancient Traditional Community
  - 71-80 Colonial Period Ruin
  - 81-90 Fallen Down Ruin Roll Again for Building
  - 91-99 Old Burned Wreck Roll Again for Building
  - 100 Recently Burned Roll Again for Building
- 11-20 Private Home
- 21-25 Church
- 26-30 Graveyard
- 31-40 School
- 41-45 Bank
- 46-50 Feed Store
- 51-60 Drugstore
- 61-65 Five and Dime
- 66-70 Clothing Store
- 71-75 Town Hall
- 76-80 Fire Station
- 81-85 Library
- 86-90 Bar or Tavern
- 91-95 Diner
- 96-00 Gas Station

### STEP 3

One of the most important aspects of scenario design is the way that the characters will enter into it. The following table offers a range of possible Player Introductions for a supernatural scenario.

#### SCENARIO INTRODUCTION

It's also possible to use this table several times for a single scenario. For example, if the first clue is fairly obscure, the group may ignore it. As the scenario progresses, just roll up another.

Let's say you're putting together a scenario involving a possession of a teenager by a powerful entity. Just to try out the table, I roll the dice and get 14, 51 and 43. Rearranging things to suit the adventure I decide that the first clue will be a major media story (the 43), a television item about a teenage boy who is attracting a large following for his rock and roll band. The second clue will be an item one of the character's discovers in an old bood (the 51) reading, "While possessed by the Demon, the Most Rev. Wal. Thamuelson was able to attract large multitudes to his services, with gentleman. In attendance who had formerly complained of the Rev.'s extreme use of pauses and etc..." The final clue will be a visit from the teen's mother (the 14), complaining of her son's weird behavior.

**1-10 Predicted by P.C.C.:** One of the player characters, or a NPC close to the player group, has a premonition of the scenario. Divination and Seance activities are two possibilities.

- 11-20 Contacted for Help:** Someone seeks out the group specifically to ask for their help with the scenario. This can range from a member of a victim's family, all the way up to members of a powerful government agency.
- 21-25 Psychic Clue:** One of the player characters, usually a psychic sensitive or psimechanic, detects some clue about the supernatural event.
- 26-30 Arcane Clue:** A player character familiar with magic and the arcane starts to notice changes that indicate the supernatural event. This can be anything from changes in the effects of a spells, to drastic changes in the behavior of an powerful artifact.
- 31-35 Minor Newspaper or Radio Item:** A small mention is made of the phenomena, usually described as a "crank" item.
- 36-40 Occult Journal Report:** A publication dedicated to some aspect of the occultist arts prints a report on the phenomena. These magazines are usually devoted to some form of divination, usually Astrology or Numerology.
- 41-45 Major Media Report:** Standard television, radio or newspaper covers the supernatural event as if it were some kind of unusual natural event. For example, the press might describe Earth Tremors, Fires, even Murders and other crimes, as simply being "unexplained."
- 46-50 Physical Evidence:** A bit of blood or flesh, some small drip of ectoplasm, or any physical clue of the supernatural event. It doesn't have to be big or gory, just so long as there is some small item that points to the supernatural phenomena.
- 51-55 Historical/Archaeological Lead:** In investigating written materials, the characters' come across descriptions of mythic events that sound suspiciously like things that are currently taking place.
- 56-60 Subtle Hints of Being Hunted:** A subtle threat might be a series of suspicious "accidents" that the character barely escapes. Another excellent "hint" is when sensitive animals or people (winos, small children) start acting fearfully around the character, not afraid of the character but of something around the character.
- 61-65 Threats on Player Character:** One or more of the player characters starts receiving threats. The character might receive a letter from a relative or an associate saying, "I fear that whatever pursues me will not be satisfied, it will hunt you down next!" Telephone calls and other direct threats are also a possibility.
- 66-70 Sudden, Violent Attack:** Without warning, one of the player characters will be ambushed and attacked by some evil force.
- 71-75 Just a feeling in the air...:** One of the P.C.C. characters just starts feeling uneasy about something. Any Psychic Sensitive, when "Opening" themselves, will sense some foreboding evil.
- 76-80 Public Problems of Persecution:** The player group suddenly finds themselves being persecuted in various ways. Anonymous tips are given to reporters, their landlords, and others who react poorly to "weirdo psychics." Also can involve strange groups spreading hate propoganda advocating the burning of "witches" and "sorcerers."



**81-85 A Forgotten Incident:** One of the player characters will suddenly remember an obscure event from childhood or the distant past. This will in some way be connected with the current situation.

**86-90 Public Declaration:** The supernatural opposition simply makes its intentions known publicly. Usually this means a monster, or some possessed person, announcing on television exactly what deeds they intend to perform. Remember that most people will think of these outbursts as simply the spouting of madmen, and any "monsters" are probably just special effects.

**91-95 Major Portents:** All over the world strange things start to happen. Rains of frogs and stones, plagues of ghosts, wierd lights in the sky. Every day the newspapers are filled with things happening internationally, and the events continue to increase every day until the supernatural event is located.

**96-00 Happenstance:** The characters just walk into the wrong place at the wrong time. Player characters will, without warning, stumble on the phenomenon as it manifests itself in its fully powered form.

**NOTE:** If the scenario is to be part of a campaign, no matter how irregular, it's a good idea to *foreshadow* upcoming adventures. That means the Game Master should drop a few hints, as far in advance as possible. This can take the form of ominous signs or warnings by strange NPCs. The best tactic of all for a campaign is to use an integrated longterm prophecy. For example, in the group's first adventure they could receive the following:

"...and it will come to pass, in the days of ignorance and sloth, that the barriers of Thu'thu'llhul'Thom will shatter. This will be foretold by the coming of the Hairy One in the West, and the Death-Bringer from the East. Then, from the South, She-Who-Has-No-Body will gather her followers until they are all of one mind. And then the great northern barrier itself will yield and the great ruin will begin."

See how that works? It doesn't actually say what's coming, but it sure gives some broad hints. The player characters may even ignore it for awhile, but after fighting a werewolf in Oregon (the West coast) and a vampire in Rhode Island (the East coast), they may start to get a little itchy. And you can believe they'll start studying their Canadian maps when they finally discover the Greater Entity in Mexico.

## THE WORLD OF BEYOND THE SUPERNATURAL

Ley Lines, Points of Power, Psychics Investigators, Arcane Magic. All these things have existed in the *imaginary world* of **Beyond the Supernatural** for thousands of years. So the players will often meet other forces with an interest in these matters. Here are three groups that player characters may run into while in search of paranormal activities; GM's option.

### THE RUMPAL FAMILY

Lynn Rumpal is a driven man, and totally psychotic in his desire to gain power and control over psychic phenomena. He only uses his *natural* psychic abilities as a tool toward achieving greater and greater knowledge of the arcane. Magic thrills him, and any powerful artifacts are an obsession.

He is capable of anything, up to and including murder. Yet he is restrained by his need for the support of his sister Jan, and his wife, Donna. They are just too vital to his pursuit for him to lose them. Understanding their squeamish qualms, he will *never* lose his cool in their presence. That means he'll never commit any violent or evil act as long as they are somewhere around.

He's also a magnificent, pathological liar. When accused of any wrongdoing, his immediate impulse is to coolly ask for a clarification. "Hmmm . . . So what you are saying – and please correct me if I've somehow misunderstood – you are saying that I deliberately removed the book from its place of holding? And you say that knowing full well that you, yourself, laid hands on the book. I might point out that the book, the one you accuse me of taking, now rests in **your** hands."

Both Lynn, and his sister, Jan Rumpal, are 7th level **Physical Psychics**. Lynn's other primary ally is his wife, Donna, a 4th level **Psychic Sensitive**. Both of the woman have been thoroughly fooled by Lynn's outward lies and deceptions. They believe him to be a sincere seeker after truth, a little obsessed, but with a good heart.

Having inherited a substantial sum from Donna's parents, the family now travels around the country in a large camper van. They avidly read newspapers looking for accounts of supernatural activity, and also rely on Donna's sensitivity to lead them to sources of the paranormal.

Initially, in any contact with player characters, the Rumpals will seem friendly and helpful. It is only after some valuable mystic artifact or power is found that Lynn's greed will surface.

**Name:** Lynn Rumpal

**Alignment:** Diabolic

**Attributes:** I.Q.: 20, M.E.: 16, M.A.: 13, P.P.: 6, P.E.: 8, P.S.: 15, P.B.: 14, Spd.: 12

**P.C.C. Type:** Physical Psychic

**P.C.C. Level:** 7th

**I.S.P.:** 81                      **P.P.E.:** 6

**Hit Points:** 18                      **S.D.C.:** 43

**Natural Abilities:** None.

**Attacks per Melee:** 5 Psychic, or 5 Physical (Hand to Hand: Basic), but he can't do both at the same time (5 total attacks per melee).

**Bonuses:** +1 to Strike, +2 to Damage, +3 to Parry/Dodge, +2 to Roll with Punch/Fall, +1 against Magic, +5 against Possession, +2 against Horror Factor. Needs a 10 or higher to save vs psychic attacks.

**Magic:** None, but he's seeking to gain these powers.

**Psychic Powers:** Alter Aura, Ectoplasm, Impervious to Poison/Toxin, Levitation, Meditation, Mind Block, Summon Inner Strength, and Total Recall.

**Level of Education:** Masters degree in Archeology (+25% +6% I.Q. bonus on scholastic skills).

**Skill Programs:** Journalism/Investigation, Technical (History, Archaeology, Photography, Lore: Ghosts & Faeries, Lore: Geomancy), Weapon Proficiencies (Blunt, Revolver, Rifle), 10 Secondary Skills (+6% skill bonus).

**Physical Description:** 6ft 2in tall, and 165 pounds, Lynn is a lean, hyperactive man. He has greying hair, piercing, blue eyes, and speaks very quickly.



**Name:** Jan Rumpal  
**Alignment:** Anarchist  
**Attributes:** I.Q.: 14, M.E.: 19, M.A.: 16, P.P.: 9, P.E.: 5, P.S.: 7, P.B.: 13, Spd.: 10  
**P.C.C. Type:** Physical Psychic  
**P.C.C. Level:** 7th  
**I.S.P.:** 74      **P.P.E.:** 8  
**Hit Points:** 21      **S.D.C.:** 24  
**Natural Abilities:** Physical Psychic  
**Attacks per Melee:** 2 (No hand to hand skill),  
**Bonuses:** None for Combat, +1 against Magic, +5 against Possession, +2 against Horror Factor. Needs a 10 or higher to save vs psychic attack.  
**Magic:** None  
**Psychic Powers:** Bio-Manipulation, Ectoplasm, Hydrokinesis, Impervious to Fire/Heat, Pyrokinesis, Summon Inner Strength, and Telekinesis.  
**Skill Programs:** Language: Spanish, French, Latin; Electrical, Technical (Art, History, Research, Photography, Writing). 8 Secondary Skills.  
**Physical Description:** 5ft 10in tall, and 115 pounds, Jan is a lean and hyperactive, much like her brother. She also has greying hair and piercing, blue eyes. Her manner is laid back and she often seems like a nervous cat, eyeing a mousehole.

**Name:** Donna Rumpal  
**Alignment:** Scrupulous  
**Attributes:** I.Q.: 7, M.E.: 22, M.A.: 7, P.P.: 10, P.E.: 4, P.S.: 6, P.B.: 7, Spd.: 6  
**P.C.C. Type:** Psychic Sensitive  
**P.C.C. Level:** 4th  
**I.S.P.:** 47      **P.P.E.:** 5  
**Hit Points:** 12      **S.D.C.:** 18  
**Natural Abilities:** Psychic Sensitive  
**Attacks per Melee:** 2, no combat bonuses.  
**Bonuses:** None for Combat, +1 against Magic, +3 against Possession, +3 against Horror Factor. Needs a 10 or 15 to save vs psychic attack (see Psychic Sensitive).  
**Magic:** None  
**Psychic Powers:** Astral Projection, Clairvoyance, Divination (Rune Stones), Empathy, Mediumship/Clairsentience, Object Read, and See Aura.  
**Level of Education:** One year of college (+10% scholastic skill bonus).  
**Skill Programs:** Electrical, Technical (Art, History, Journalism, Lore: Religion, Lore: Demons & Monsters). 8 Secondary Skills (one is speaks Spanish).  
**Physical Description:** 5ft 2in tall, and 85 pounds, Jan is skinny and withdrawn. She has washed-out blond hair and dull, brown eyes. She seems constantly frightened by everything and is totally dependent on her husband and sister-in-law.

#### TAL-AGEN-VA

Tal-Agen-Va, otherwise known as Phillip Donaldson, is an infamous, mysterious billionaire. His real persona is that of an 21st level Mage/Arcanist who looks eighty years old and whose real age is actually more than **ten times that**. If it were his wish, he could stop most player characters, or virtually any creatures, in an instant. But that would not serve his aims. He lives on the stuff that leaks through the ley lines and power points, and he

dreams of ruling the world with the vast power he can eventually harness. Player characters, and other investigators into the paranormal, he considers to be mere pathfinders; the *dogs* who search out precious treasures.

Once he locates a group of psychic investigators (the players), he will send out his lowest level operatives, the **dead**, to observe. These creatures will simply follow the characters around, making regular reports and not interfering in any way. If they fail to keep up with the characters they will eventually be replaced by higher level operatives.

**Phillip Donaldson's organization of operatives is broken into five levels. Starting at the top, they are:**

- 1. The Household.** These are very powerful human servants. Usually one of the P.C.C.s, they have been granted magical powers and Entities as servants. Many of them are also hundreds of years old. All are 100% loyal, although each is smart enough to horde powerful artifacts that might be concealed.
- 2. The Councilors** – Ambitious employees within Donaldson's corporate holdings are sometimes given the opportunity to gain occult powers. However, they must first prove themselves by spending 10 or more years in service. They are highly intelligent and very ambitious. Their major weakness is their curiosity about the supernatural.
- 3. The Beasts** – Creatures from a variety of dimensions, they have been enslaved and are kept in the dungeons under Donaldson's mansion. Usually used only as assassins or hunters, they are too unreliable for complicated missions. They have no loyalties, just hungers.
- 4. The Agents** – Many of Donaldson's most loyal servants are intelligent Entities. These have been given durable bodies to inhabit and are allowed to feed whatever strange urges they may have. In return, they blindly obey any missions given to them by their master.
- 5. The Dead** – These are former employees (and occasionally, former enemies) of Mr. Donaldson. Former is the appropriate term since all of them are quite dead. They have been brought back to life, by being animated by low-level, nonintelligent Entities.

#### PHILLIP DONALDSON

**Real Name:** Tal-Agen-Va  
**Alignment:** Aberrant  
**Attributes:** I.Q.: 24, M.E.: 19, M.A.: 14, P.P.: 3, P.E.: 3, P.S.: 5, P.B.: 4, Spd.: 2, (physically weak with age. Stays mostly in his wheelchair, but can walk if necessary).  
**P.C.C. Type:** Arcanist/Mage  
**P.C.C. Level:** 21st  
**I.S.P.:** None      **P.P.E.:** 14  
**Hit Points:** 8      **S.D.C.:** 13  
**Natural Abilities:** None  
**Attacks per Melee:** Magical or 2 Physical  
**Bonuses:** None for Combat, +10 against Psychic Attack, +10 against Magic, +10 against Possession, +14 against Horror Factor.

**Magic:** Enormous powers are at his disposal, including a full range of Entities, ranging from mere Poltergeists to Greater Entities. He is also a master of the Necromantic Arts, capable of Resurrecting the Dead, Animating the Dead and Enslaving the Dead. Knows most magic (about 85%).



**Psychic Powers:** None. He relies on his servants for these powers.

**Skill:** Using spells of memorization he has absorbed the knowledge of many fields of human research and knowledge. Knows the following all at 94% skill proficiency: Communications — select six, computer — all, electrical — all, espionage — select eight, mechanical — select three, medical — all, physical — hand to hand: expert, swimming, fencing (note: physical impairment prevents other skill areas), pilot: basic — all, pilot related — all, science — select eight, technical — all, W.P. knife, W.P. sword, W.P. targeting, W.P. revolver, W.P. automatic pistol, W.P. submachine gun, W.P. energy pistol, W.P. energy rifle (has energy weapons available to him). Plus Arcanist/Magic knowledge (spells & summoning are his favorites).

**Physical Description:** 5ft tall, and 189 pounds, Tal-Agen-Va is a tubby man who usually does not leave his *wheelchair*. He is completely hairless, and his eyes are covered with a mystic red film, making them appear as red orbs. He can also cast spells of concealment, disguising himself in any way he chooses. His voice is deep and powerful, and instantly recognizable to any of his underlings.

## THE PRODUCTION CREW OF SUPER-NATURAL? OR SUPER-NUTS?

**Super-Natural? Or Super-Nuts?** is a highly rated, syndicated television show. It's host, Lance Goodenoof, is the hard-hitting interviewer and narrator. He's also a 6th level Nega Psychic. Like most Nega Psychics, Lance is a total skeptic about the supernatural. He enjoys doing the show because it allows him to ridicule and humiliate mediums and psychic investigators. Here's how a broadcast would typically end:

"Here we have some footage we shot of the mystery 'Mound of Horror' that's been terrorizing Haines County, Idaho, for the last two weeks. Of course, we didn't see any of the famous apparitions. We only have the sworn statements of the local tourist board that such things *were* seen."

"Now here we see a second *mound*. This one was actually put together by our cameraman. All he did was mix up a few brands of kids' cereal with some liquid glue. So you, the viewer, can judge for yourself. Is the Haines County mound a remnant of a ghostly event? Or is it just another Junior High School prank?"

"*Super-Natural? Or just Super-Nuts?* As always, we leave the decision up to you!"

"This is Lance Goodenoof, hoping that you'll tune in next week. When we'll show you the true story which we call the Philadelphia Monster Hoax!"

The show's *director*, and part time camerawoman, is Mildred Florentino. She's also a Nega-Psychic, 5th level. She also writes a syndicated newspaper column called **Bunk and Debunk**, in which she ridicules people writing in about psychic phenomena. A typical letter might read, ". . . granpa's ghost has appeared in the corn shed every August for the last thirty-five years, can you help us?" Her reply would be, "I'd suggest you stop dipping into the corn whisky before you go out in the shed, then maybe you'd realize how stupid that sounds."

The last member of the T.V. crew is a Psi Mechanic, Rusty Brooder. He's only capable of putting together a couple of de-

vices. Also, he's not a very good cameraman, so he tends to miss crucial shots through sheer incompetence. However, his **Mind Blocked** cameras can record events without being affected by most supernatural events. This special *skill* has persuaded Lance and Mildred to keep Rusty around.

The worst thing about the Goodenoof show is that they've become *the* specialists on the supernatural in the media world. As a result, any attempt to report a story on paranormal activity will usually mean they'll be notified. They typically show up in an unmarked utility truck filled with television cameras and equipment.

**Name:** Lance Goodenoof

**Alignment:** Miscreant

**Attributes:** I.Q.: 9, M.E.: 7, M.A.: 17, P.P.: 17, P.E.: 14, P.S.: 18, P.B.: 20, Spd.: 13

**P.C.C. Type:** Nega Psychic

**P.C.C. Level:** 6th

**Negative P.P.E.:** 6

**Attacks per Melee:** 5, in hand-to-hand (martial arts).

**Bonuses:** +3 to Strike, +4 to Parry, +4 to Dodge, +4 to roll with punch, +2 to damage, +6 against Psychic Attack, +4 against Magic, +2 against Possession, +6 against Horror Factor.

**Magic:** None

**Psychic Powers:** None

**Level of Education:** 4 years of college (+20% in all scholastic skills).

**Skill Programs:** Journalism/Investigation, Physical (Hand to Hand: Martial Arts, Body Building, Acrobatics and Running).

**Physical Description:** 6ft tall, and 170 pounds, Lance is a well built, and very handsome man. He has perfectly groomed reddish-blond hair, dark blue eyes and he speaks with a radio announcer's deep voice.

**Name:** Mildred Florentino.

**Alignment:** Anarchist

**Attributes:** I.Q.: 19, M.E.: 10, M.A.: 13, P.P.: 12, P.E.: 14, P.S.: 10, P.B.: 11, Spd.: 7

**P.C.C. Type:** Nega Psychic

**P.C.C. Level:** 6th

**Negative P.P.E.:** 10

**Hit Points:** 15 **S.D.C.:** 28

**Natural Abilities:** Permanent Nega Psychic Mind Block

**Attacks per Melee:** 2 (no hand to hand skill)

**Bonuses:** None for Combat, +3 against Psychic Attack, No bonus against Magic, +4 against Possession, +4 against Horror Factor.

**Magic:** None

**Psychic Powers:** Nega Psychic

**Level of Education:** Masters in Journalism (+30% scholastic skill bonus, +5% I.Q. bonus).

**Skill Programs:** Journalism/Investigation, Communications, Electrical. 10 Secondary Skills (+5% skill bonus).

**Physical Description:** 6ft tall, and 145 pounds, Mildred is an imposing, forceful woman. She speaks rapidly, in machine-gun fashion, laying out exactly what she wants from people. She has black hair, very dark eyes and a very sharp look.

**Name:** Rusty Brooder

**Alignment:** Scrupulous



**Attributes:** I.Q.: 7, M.E.: 11, M.A.: 6, P.P.: 7, P.E.: 6, P.S.: 10, P.B.: 4, Spd.: 10  
**P.C.C. Type:** Psi Mechanic  
**P.C.C. Level:** 2nd  
**Permanent P.P.E.:** 10    **Building P.P.E.:** 14 (available)  
**I.S.P.:** 50    **Hit Points:** 5D6    **S.D.C.:** 20 + 4D6

**Natural Abilities:** Rusty can build and operate devices with the abilities of *Mind Block* or *See the Invisible*. Usually he only uses them in specially modified cameras. Since his *See the Invisible* cameras record otherwise unseen things, the films are often used as evidence of "fakery."

**Attacks per Melee:** 2, (no hand to hand combat skill)

**Bonuses:** None for Combat, No bonus against Magic, +1 against Possession, +2 against Horror Factor. Needs a 13 or higher to save vs psychic attack.

**Magic:** None

**Psychic Powers:** None

**Level of Education:** One year college, but is quiet incompetent.

**Skill Programs:** Journalism/Investigation (all with a +15% bonus), Communications (all with no bonus due to incompetence), Electronics (all, with a mere +10% due to incompetence). 8 Secondary Skills.

**Physical Description:** 5ft 5in tall, and 105 pounds, Rusty is a skinny, nervous-looking youth. He has mousy brown hair, green eyes, and talks in a whisper that can barely be heard. He seems scared of just about everything and is often clumsy.

## PROFESSOR VICTOR LAZLO

Victor Lazlo is a paradoxical character. To his colleagues in parapsychology he was many different things to many people. To a few he was a genius, the guru of parapsychology and the definitive authority on magic and the supernatural. To some he was a glory seeking charlatan who was single-handedly destroying the credibility of parapsychological science. To others he was an eccentric radical who had gone too far. However, most of his colleagues and other members of the scientific community believed Lazlo to be a quack or a madman who pestered them incessantly with his outrageous observations, claims, theories and preposterous artifacts.

In reality, Victor Lazlo was a dedicated purveyor of truth. The eternal optimist, he was undaunted in his research, heedless of the personal dangers and public ridicule. During his three decades as a psychic investigator, Lazlo made many keen observations and developed very astute theories regarding the paranormal. Theories that ruined his career as a parapsychologist. Officially branded a fraud and nut-case by parapsychologists, Lazlo carried his crusade to the public where he became a popular cult hero among the science fiction and occult crowd. However, he soon broke into the mainstream market with his infamous book, **Worlds within Worlds**, which dominated the best-sellers' number one spot for 13 weeks. Three subsequent best-selling books had made Lazlo the Carl Sagan of the paranormal.

His career as a popular author rocketing to new heights and with contracts signed for a PBS television series, Lazlo vanished. Like a page out of one of his books, the disappearance of Victor Lazlo is wrapped in mystery. It was the eve of the winter solstice at the famous *Serpent Mound of Adam's County, Ohio*. Lazlo had returned to the indian mound which had so often intrigued

him. It was just a stop on the way to visit a colleague at Michigan State University. His assistant, Jawaharlal Kishwar, would report that Professor Lazlo elected to stay the night at the mound, while Kishwar accompanied their car, in tow, to a local gas station for a fuel pump replacement. Armed with sleeping bag, lantern, canteen, camera, folding chair, his "bag" and diary, Lazlo settled in for his overnight stay. His assistant says that he pleaded with the professor to return to town with him. That he had felt the stir of *restless spirits* and feared for his friend. Unconvinced, Lazlo dismissed his pupil and took out his diary to record his thoughts. The last passage in his journal indicates no such fears on his part:

*"It is an unseasonably warm afternoon for an Ohio December. There's no snow on the ground yet and a gentle breeze passes that must be the last warm fingers of autumn. I'm drawn again to this indian serpent mound. All my usual questions and speculations are doing a warpath in my head. I don't know why I find this place so alluring. I guess, for me it's the North American Stonehenge.*

*"Jawaharlal has warned me that he feels restless spirits afoot here. I hope so. I'd like to experience something extraordinary at my favorite megalithic site. But I don't sense a thing. 'Jay' has learned to master his psychic sensitive abilities surprisingly well over the past few months (I only wish he'd master the English language as quickly. Ha!). This time, however, I think it's his paternal instincts coming forth and not psychic intuition. It's getting dark quickly now. I'll have to set up camp and the lantern before I can continue. More later."*

Those were the last words from Victor Lazlo. The rest of the page is blank, his uncapped pen was found marking its place. The lantern and all equipment were found the next morning, but Professor Lazlo was gone. There was no sign of foul play or anything unusual. Yet nobody has seen or heard from Victor Lazlo since that December afternoon in 1984.

## Professor Victor Lazlo

**Psychic Character Class:** Latent Psychic

**I.S.P.:** 100 **Hit Points:** 49 **S.D.C.:** 11

**P.P.E. Base:** 11

**Alignment:** Scrupulous

**Attributes:** I.Q. 14, M.E. 19, M.A. 13, P.S. 12, P.P. 11, P.E. 14, P.B. 10, Spd. 8

**Age:** 54 when he disappeared in December, 1984.

**Weight:** 165lbs **Height:** 5ft 11in

**Disposition:** Clever, confident, tough, self-reliant, tended to be an impudent lone wolf.

**Level of Experience:** 8th level

**Level of Education:** Ph.D. in History and a Bachelor's degree in Science.

**Occupation:** Psychic Investigator/College Professor/Parapsychologist

**Skills:** Parapsychology — 98%, Computer Operation — 98%, Biology — 98%, Anthropology — 98%, Archaeology — 98%, Mathematics: Advanced — 98%, History — 98%, Lore: Demons — 98%, and Monsters — 98%, Lore: Ghosts & Faeries — 98%, Lore: Geomancy and Lines of Power — 98%, Lore: Religion — 98%, Intelligence (Journalism program) — 98%, Photography — 98%, Research — 98%, Languages: Latin, French and Spanish, all at 98%.



**Secondary Skills:** Cook — 98%, Fish — 98%, Land Navigation — 72%, Pick Locks — 75%, Pilot: Automobile — 98%, Pilot: Truck — 98%, Pilot: Sailboat — 98%, Hand to Hand: Basic, Climbing, W.P. Automatic Pistol.

**Psychic Abilities:** Meditation, Clairvoyance, Impervious to Cold, Mind Block, Sense Magic, See the Invisible, Speed Reading.

**Bonuses:** +3 save vs horror factor, +1 to save vs magic, +1 save vs possession.

# Adventures

## TEENY-BOPPER TERROR OR THE TOMB OF THE PERPETUALLY COOL ADOLESCENTS

A Beyond the Supernatural Adventure Scenario  
BY ERICK WUJCIK

**NOTE:** This is an beginner-level adventure designed for *Victim characters*. It works best if the player characters are rolled up specifically for this adventure. Total play time, including character generation, should be about four hours. **WARNING:** This is a pretty silly adventure; just remember that it's supposed to be *fun*.

### GENERATING THE TEENY-BOPPER PLAYER CHARACTERS

This scenario calls for all the players to take the part of *13-year-old girls*. Unless, by some incredible coincidence, the players have already created some characters like this, they'll have to spend a little time creating the player characters. Just follow these steps for creating "victim" characters:

Step 1 — Roll up the character attributes.

Step 2 — Roll up the four background percentiles.

Step 3 — GM determines the character's secret potential.

Step 4 — Players must choose names for their characters.

**Note:** Alignments are optional.

Remember, the whole point of generating characters for this adventure is to get the players involved in their characters. Try to make everything fit together. For example, let's assume that one of the characters scores low in Social Acceptability. If her P.B. (Physical Beauty) is also low then you can explain that she has problems fitting in because she's not as good looking as the other girls. If her P.B. is high, then explain that she's not popular because she's too pretty for the other girls. You can do use the same kind of twisted logic with P.P. (too clumsy or too athletic) and I.Q. (too smart or too dumb).

**Step 1** — Have the players roll 2D6 (that's just two six-sided dice) for each of the standard attributes. The usual I.Q., M.E., M.A., P.S., P.P., P.E., P.B., and Spd. Do not have them roll for P.P.E. or Hit Points.

**Step 2** — Have the players roll percentile for each of the following background items: **Maturity, Social Acceptability, Baby-Sitting Ability, and Parental Acceptability.**

### LEVEL OF ADOLESCENT MATURITY (Roll Percentile)

Depending on what the player rolls, read the appropriate section. Remember, that no matter what a player rolls, two things are true. They're embarrassed by what's happening biologically. And none of it has any bearing on the adventure whatsoever.

**01-25** "Your character is still a little girl. Nature hasn't yet seen fit to perform any little miracles on your character. From the point of view of the character, that means she's still just a kid. If any of her friends knew about this she'd be embarrassed enough to just wrinkle up and *die!*"

**26-50** "Nature is playing evil tricks on your kid. She has the hormonal changes and all the incredibly icky stuff that comes with it, but there's no *physical* change. Like, ah, up front? You know what I mean. It's all so incredibly embarrassing and like to die!"

**51-90** "Hormones are slowly turning this girl-child into a woman. She's growing up and it's all incredibly embarrassing. She's not sure if any of the changes in her body are right. I mean, like what if it's cancer or something? And you can't talk to anyone about it, because you'd just *die!*"

**91-00** "Your character is over-developed to the point where she can pass for someone a lot older. She receives unwanted and critically embarrassing comments from adults. She doesn't want to talk about it to anyone. In order to avoid being embarrassed by the obvious she tries to cover up a lot. She just dies any time anyone makes any reference to her figure."

### LEVEL OF SOCIAL ACCEPTABILITY (Roll Percentile)

Belonging to a group of social peers is all-important to a girl in her early teens. Belonging is more important than anything, including food, music or boys. Parents, school and other unimportant trivia don't even come close. Read the section corresponding to the player's roll. For the purposes of this game, the GM can use the dynamics of the group to keep the players in character and together.

**01-20** "Argghhh! Your character is the one of the most unpopular girls in the group. You barely belong at all! If they're going somewhere and they don't have enough tickets, or enough room in the car, *you're* the one they're going to leave behind. You'd do *anything* to be more popular. And if they ever dropped you, your life would be over."

**21-70** "The most comforting thing about your entire miserable life is the fact that you've got friends. Just to make sure they stay your friends, you dress like them, talk like them, and go along with anything the group wants to do. If you ever had to leave the group your life would be over."

**71-90** "Fortunately you are a very popular girl. A valuable addition to your group. You *know* exactly what to wear, what to say, and how to act so that you'll blend right in with everybody else. And being different is really dangerous. Somebody who is different might not belong. And, since your group is the most important thing in the world, you know that without it, your life would be over."



**91-00** “Not only are you *in* the group, you can control the group. Of course, you’d rather be hanging out with that group of 14-year-olds, but they’re too stuck-up to have anything to do with you. So you hang around with this group of babies. After all, it’s better than being alone. Being alone would mean your life would be over.”

#### LEVEL OF BABY-SITTING ABILITY (Roll Percentile)

Thirteen is the perfect age for baby-sitters. It combines economic need with natural ability. Most girls of this age can still understand the prattle of babies and toddlers. They’re also really good at intimidating small children. For the purposes of this adventure, the Eyeless Kroth are suckers for anyone with a high (31 or better) score in Baby-Sitting Ability.

**01-20** “You hate little kids, they’re just so dirty! You hate baby-sitting. And you avoid it all whenever you can.”

**21-30** “Little kids are all right, but boring. Unfortunately, just about the only way you can make any money is by baby-sitting. So you put up with it when you have to.”

**31-85** “For some reason you can understand what babies and toddlers are saying when they babble. This is something that even their mothers can’t figure out. Your ability to get along with kids means you can make money as a baby-sitter. And the kids like you so much that they even request you as their favorite sitter.”

**85-00** “You get along great with little kids, babies and toddlers. You always know exactly what they want. Better yet, you can always manipulate them so they’ll do exactly what you want. This makes you very popular among the parents as a baby-sitter. It’s not something you’d want to tell the other girls about, but you think you even enjoy being around children.”

#### LEVEL OF PARENTAL ACCEPTABILITY (Roll Percentile)

Most 13-year-old girl characters hate their parents. Read the entry that corresponds to the player’s roll.

**01-10** “Your parents don’t have much any money at all. Which means they don’t let *you* have any of it. And they argue with you about everything. They don’t like your hair, your friends, your clothes, or anything. Actually, you’d just rather not ever talk about them. You start the game totally broke.”

**11-60** “Your parents are real misers. They complain about every penny. Getting them to buy you anything is always a big deal. You start the game with \$3.00.”

**61-99** “Your parents have lots of money. Which doesn’t help you much since you can’t get any of it without a huge fight. They just don’t seem to understand what’s important in life. They’re always complaining about how much things cost. Don’t they understand that records, and clothes, and movies cost a lot because they are important? You start the game with \$10.00.”

**100** “You love your parents. That’s because they are very, very rich. Maybe not as rich as your friends think, but rich enough to give you everything you want. Including your own credit cards, your own telephone, and enough money to treat your friends to anything you want to give them. You start the game with \$35.00.”

Being unhappy with one’s parents just sort of comes with being a thirteen-year-old girl. There are plenty of reasons why

parents are embarrassing and irritating. Even if they are rich. Here’s a list of some really *awful* things to say about the character’s parents. Make sure every player gets a different reason.

1. “Your father and mother both work and have no time for you. You hate them.”
2. “Your parents are immigrants who talk about taking you back to the “old country.” They also talk about marrying you off to a distant relative who has never been off the farm. You hate them.”
3. “Your parents assume that you will eventually become a nice little wife and mother with about a hundred babies. They don’t expect you to study because they think you’re stupid. You hate them.”
4. “Your parents are trying to get you into Harvard or something. They expect you to give up your entire life and spend every minute studying. You hate them.”
5. “Your parents had six other kids after you were born. They obviously hated you ever since you were a baby, otherwise they would have been satisfied with having just you. Not only that, but they also assume that you were born to be a slave that takes care of the other kids. You hate them (and you hate your little brothers and sisters double).”
6. “Your mother and father seem to have nothing better to do than to bother you about every little detail in your life. They always want you to talk about every problem, no matter how embarrassing. You hate them.”
7. “Your mother and father do the most amazing embarrassing things. They go out. They hold hands. They sing dumb songs. They kiss each other all the time. Even in front of other people. You hate them.”
8. “Your father works as a garbage collector. That’s just too embarrassing, so you lie and tell your friends that he’s really an airline pilot.”
9. “Your parents are always telling you to work harder so you can be just as good, and smart, and precious, as your older sister. She’s in high school and she talks to you as if you were some kind of *child!* You hate all of them.”

**Step 3** — You, the game master, collect all character sheets, and compare the attributes. Every character has to have *one secret potential*, based on their attributes. The second thing is that you need to make sure that there are at least *one of every type* in the group. If the group is less than four, then assign more than one secret potential to each character. Remember, these are *secret potentials*. Make a note of each one, but don’t tell the players about them.

#### SECRET CHARACTER POTENTIALS

The character’s potential is something that the game master should *not* tell the players about.

Whoever is high in I.Q. has the potential to be a Mage. Raise their I.Q. to 13.

Whoever is high in M.E. or high in Baby Sitting Ability, has the potential to be a **Psychic**. Raise their M.E. to 13.

Whoever is high in M.A. or P.B., or has a high number for Social Acceptability, has the potential to be a Princess. Raise their M.A. to 13.

Whoever is high in P.P. or P.S. or P.E. has the potential to be a Valkyrie. Raise the P.P. to 13.



## THE TOWN: A PLAYER'S INTRODUCTION

Read the following for the players:

"There are three important places near where you live. The most important is **Your Hang-out**. Every day, right after school, all the girls always hang out at exactly the same spot every day. The special spot is the north entrance to the local *shopping mall*. The second important place are **Your Houses**. These are all on the same street, within two blocks, either side of the local library. Getting from the hang-out to home is a very boring, twenty minute walk. You can get from one place to another by bus in just five minutes for fifty cents each. The most interesting way to get around is by taxicab, but that costs \$3.00 each way, and the cabby will get mad if he doesn't get at least a \$1.00 for a tip." The third important place is **The Library**. A boring place, but a great reason to get out of the house and maybe meet with the girls.

## ENCOUNTERS

### 1. Discovery of the Sewer Grate.

When you're ready to start the game, read the following to the players:

"Right after school, you all get together and walk straight over to your favorite hangout spot. You're happy as can be, walking along with the group, when you notice something very wrong. There are a couple of dirty, little, nine-year-old boys hanging off the curb and fooling around with the sewer cover. In *your* favorite hang-out! What are you going to do?"

If necessary, remind the players that this is their turf, and that grimy little boys should know better than to try hanging out here. The players can attempt to get rid of the little boys in several ways. The easiest is by intimidation, threatening them with their mothers or higher authority. A less ladylike way, and therefore, less socially acceptable, is by physical violence. Remind the players that brawling is pretty childlike. It doesn't take much to chase the boys away, they'll just cry about "We found it first!" and "That's not fair!"

*Whenever one of the player characters looks down at what the boys were playing with, read the following:*

"You look down and notice that this sewer cover is not like any of the others in the area. All the others just have straight slits for openings, and the openings in this one are all twisty and curvy, as if they were some kind of strange and elaborate writing. There's also something that looks like a *keyhole*, built into the top of the grating. Even more interesting, you see there's a bright object resting on the cement, about two feet under the grating.

*Any more investigation will reveal:*

"The shiny object seems to be a key. It seems to be made out of gold. And where you'd expect there to be a hole for a key ring, instead you see a jewel, possibly a diamond! It could be a pin or broach, but it's definitely not a normal key. What are you doing?"

**Getting the key** requires tools and a certain amount of dexterity. For tools, they can use what the boys were using; a string connected to a wad of bubble gum, or any kind of stick or chain with a pin. All it takes is one roll *under* the character's P.P. on 1D20 to get the key. Just to make it interesting, continue remind-

ing the players that this activity is both "childish" and "dirty." When any of the girls finally touches the key, read to the next section:

"You get the strangest tingling sensation when you touch the key. It's almost as if it were vibrating in your hand."

The item is not a broach. It *is* a key. But a key for what? The grate? (Yes). Trying to use the key at this point is useless. Without reciting the chant (found in the library), it will just seem as if the key doesn't quite fit in the hole at the top of the grating.

The tingling will change in strength as the girls play with it. Mainly, the tingling will be at its strongest when it's pointed toward the library.

### 2. Arrival of "The Man in Black"

Sooner or later, based mainly on the patience of you, the game master, the villain of the piece will show up. If the players are really slow, then you can speed them up with his arrival:

"Off in the distance you hear the screech of a cars wheels taking a corner too quickly. You hear it again and see a long black car pulling into the parking lot of the shopping mall down the street. It's headed right toward the strange sewer grate."

Once they get moving, either by running away into the shopping mall, or leaving the mall (by foot, bus or cab), they'll have a view of the following:

"You've never seen a car like that before. It's solid black with only a touch of gold trim here and there. It has no manufacturers insignia or emblem anywhere that you can see. The car's front doors fly open, and you see two small figures get out. They're each about two and a half feet tall, but built very wide, and each is dressed in identical dark suits. They both move back to open the rear doors on each side of the car. What are you doing?"

If they continue looking from hiding, or from the window of a cab or bus, they'll see the following:

"Coming out of the passenger side rear door of the black car you see a tall man completely covered in a long black cloak. There's even a hood on the cloak, which completely conceals the man's head. The other short guy picks up a large, heavy, ornamented book from the driver's side of the car. Immediately, without even bothering to close any of the car doors, the trio starts walking straight toward the strange sewer grate. What are you doing now?"

If anyone continues staring at the strange trio, read:

"Looking at the man in the black cloak, he suddenly looks straight toward you! Under the hood you don't see any face at all, at this distance all you can see are two, glittering, little red lights where his eyes ought to be."

Escaping should be fairly easy. Once the characters are in a cab or bus, they'll be able to get all the way to the library without any problems. If the characters were dawdling around when the car showed up, they'll have to work harder at escaping. Still, running through the crowded shopping mall, or hopping into a bus that's just about to leave, will get them away safely.

### 3. Home Sweet Home

If the girls, or the girl who is holding onto the key, ever get home, they'll be followed by old red-eyes. As soon as the girls are alone, the telephone will ring. It will always be the man in the black cloak (who we can call Red-Eyes).



Here are some typical things that Red-Eyes will say:

“You must give me the **key**.”

“If you do not give me the **key**, *I will destroy you.*”

“*No harm will come to you if you give me the key.*”

**Note** that Red-Eyes will know the names of all the player characters. He will also answer the phone no matter who they try to call, even if the call is made from a public phone.

Parents will be convinced that whoever is calling is some friend of their daughter. They will not believe any wild story about the key. If really pushed, they'll threaten to “ground” their daughter.

Another possibility is that the players may attempt to make up a believable story (“This terrible man tried to pull me into his car” or “Three guys tried to grab my purse.”) in order to get help. The results will always be the same: 1) Someone will call the police, 2) The black car will show up and the parents will say, “Good, here are the police now,” and 3) The girls will have to run to avoid being turned over to the guys in black.

Eventually, the player characters should end up running to the library.

#### 4. Exploring the Library

Read the following section as soon as the girls arrive in the library: “Once inside the library, you find that the key points *down*. You notice stairs leading down to the basement. What are you going to do?”

Fooling around anywhere else in the library will merely get them scolded by a librarian. Read when they go down the stairs:

“At the bottom of the stairs you see a door with a sign that reads, ‘Archives, please notify librarian before removing archival material.’ The key is pointing in that direction. What are you doing?”

Other than the lavatories, there's really no where else to go. Inside there are rows and rows of books. After the characters have followed the key past a few rows read:

“Searching through the stacks of old books and papers, you finally see a weird glow coming from the one of the large bound volumes on the bottom shelf. It seems to be coming from just one page in the center.”

Wait for the book to be opened and then read:

“Opening the book you quickly find the glowing section. You notice that the source of the glow is something that's actually inside one of the pages. The page seems unnaturally thick and there seems to be a piece of glowing paper inside the page itself.”

Taking out the inner sheet is fairly easy. The thick page can be cut or ripped and the inner sheet will then be available. As soon as someone gets it out and tries to read it, use the following description:

“At first you can't seem to make out the writing. Then, suddenly, you find you can read it quite clearly. Here's what it says.”

**NOTE:** Before reading the following section, you should instruct the players to write it all down. Encourage each one to make their own copy. Read it as slowly, and as many times as necessary for them to get it all written down. Yes, you can spell the difficult words and help them with pronunciation.

“WE CALL ON ADABACHEN-RA,  
GATE-KEEPER TO THE EYELESS KROTH,  
MYSTIC RENDERS SUPREME.  
WE CALL THE FEGISH AND THE THUHOHUNK  
MAY THE GATES OF WORLD FASHERAH LOOM  
TO OUR CALL.  
CALL RABEY, RABEY, RABEY.  
LET ALL THE KEEPERS OF ADABACHEN-RA  
STEP ASIDE  
FOR WE NOW CALL THE SUBLIME ASHKENOBIS-  
TAR”

**Note:** This is *not* a real magic chant.

“At the end you see a single capital letter “A“ that looks like somebody's initial. The sheet continues to glow. Who is holding the key? (to that player) The key is tingling once again, but now it seems to be pointing back the way you came. Pointing back toward the sewer grate.”

If things are getting a little slow, this is a good time to have old Red-Eyes show up again. An interesting sequence of events is to have the power go out, leaving the dark basement lit only by red 'emergency exit' signs. Attempting to leave the way they came in will mean running into Red-Eyes and his buddies. Fortunately, there's a rear stairway with an exit out onto the back parking lot.

At this point the characters will probably head back to the sewer grate.

#### 5. Using the Key

After the chant has been discovered, the keyhole still will not work unless the chant is read. Encourage the players to read it out loud, all at once.

Once the group has read the chant out loud, the keyhole will suddenly emit a bright white light. If the key is inserted read the following:

“The key makes a half-turn clockwise, seemingly all by itself. Then it pops out of the keyhole right back into your hand. You notice that the sewer grate is now filled with burning coals.”

This is exactly what happens every time the key is used properly.

It's always a good idea to have the guys in black show up part way through the ritual with the key. This keeps the group moving and keeps the excitement of the game going.

#### 6. The Eyeless Kroth

Chances are, when the group arrives back at the hang-out, they'll be looking at the sewer grate, and not at the environment. Give them time to examine the grate, and don't read the following until somebody actually *tries looking around*.

“You look up and see a huge creature looming over you! It's at least fifteen feet tall, with enormous legs, a woolly, grey body, and an enormous head. The head has only one feature, a mouth filled with hundreds of inch-long teeth. Above the mouth there's nothing but a featureless expanse of smooth grey wool. The creature makes a loud 'Whouff' sound at you.”

Attempting to use the chant will simply aggravate the Kroth. It will bellow loudly, interrupting the chant. Attempting to run, or look behind, should reveal the following:



“Turning around, you discover that you are surrounded by the huge woolly creatures. The nearest one takes a step in your direction and the mere impact of its foot on the ground creates a sound and vibration that nearly knocks you off feet. What are you doing?”

The creatures will continue to make menacing noises and will prevent them from chanting or leaving. Eventually, when someone with a decent Baby-Sitting skill (31 or better) *scolds* the creature, or *makes friendly overtures* towards a Kroth, read the following:

“At the sound of your voice (the exceptional babysitter), the creature’s tail pops up. The tail has a woolly ball on the end, and which it happily wags back and forth.”

Kroth are just so many happy puppies to any decent babysitter (they’re such children!). They like to be petted and talked to. Eventually, when this gets dull, or when they start chanting, read the following:

“There’s an audible ‘pop’ and suddenly, you see the man in black appear about thirty feet away. He’s standing over an enormous snake, with his two small henchmen on either side. You see him shake his sleeves back from his hands and discover that he has tentacles instead of fingers. He’s starting to point those tentacles right at *you*. What are you doing?”

The obvious solution is to sic’ the Kroth on ‘em. Any skilled babysitter can command the Kroth to attack Red-Eyes. When that happens, read the following:

“The big woolly beasts all suddenly turn toward the man in black and his companions. They charge, and the three men start running away. One of the creatures stomps on the snake, and the rest are running in three directions, after the man in black and his two companions. What are you doing?”

At this point, the group really *should* start reciting the chant to get on to the next stage. **If they delay**, by watching the fun, or by fooling around in some other way, read the following:

“The man in the black cape, having gained a bit on the pursuing creatures, suddenly stops and turns around. He makes a gesture and there’s a flash of light. You see one of the creatures toppling over with a big, smoking hole in its side! The man in the cape does it again, and another beast topples over. What are you doing?”

That’s their cue to leave or *chant*. They need to recite the entire chant all over again, from the beginning. At that point the key will work and they can move on to the next section.

## 7. Fegish

After escaping the world of the Kroth, read the following:

“As you look around, you find yourself in a clearing in the middle of a very dark and spooky-looking woods. All the trees are twisted and dead, with just a few, dark brown leaves. The sky overhead is a dark purple and as you look up you see a bright bolt of lightning followed by a tremendous clap of thunder. There is a narrow path leading up and away through the woods.”

The characters have two choices: wait in the clearing, or go down the path. If they wait, whether or not they try the chant and the key again, they’ll start hearing noises off in the trees.

“The noises seem to be soft, sticky, ‘slurping’ noises. And they’re getting closer. You see something fly out of the forest as if it were thrown. It lands with a ‘slurp’ and you see a mushy creature, about four feet across, with a single greenish eye looking at you. It seem to be pulling itself together, maybe for another leap. What are you doing?”

**The Fegish** (the sticky creatures) will appear in greater and greater numbers. They attack by landing on someone (although it’s pretty easy to dodge them, roll Dodge with +10) and then just sticking. The best way to escape is down the forest path.

## 8. Thuhohunk

The path through the dead forest is fairly short, but spooky. When they reach the end read the following:

“At the path’s end, you see a dark castle rising up out of a moat. The building towers over you, occasionally outlined by the frequent lightning bolts. You also see some guards who look strangely familiar. There are 20 of them and they are moving toward you, each in some kind of armor and carrying spears. What are you doing?”

The trick to the Thuhohunk is that they appear to be teen idols. In the play-test we used Michael J. Fox, but you can use whatever name you think is best. The point is that each of the girls should be thrilled by the prospect of having some time alone with their favorite heart-throb. It’s up to the GM to decide whether to give the Thuhohunk voices (telling the girls exactly what they want to hear) or to keep them mute.

“The good-looking boy looks you right in the eyes and you could just melt! Obviously he has fallen in love with you. You see him motion toward a stone bench where the two of you can sit together. Are you going with him?”

Thuhohunk will try to lure the girls away from the drawbridge, but not to the point of using force. Once across, the description the player receives will depend on their character’s secret potential. To anyone entering with Mage secret potential, read:

“You enter the castle and see that there’s just one room inside. Immediately you notice a brightly glowing object on the wall to your left. Sitting on a small shelf is a beautiful book; its cover studded with large emeralds and rubies. You sense that you are destined to possess it.”

If there is more than one Mage in the group, then they’ll either have to fight or argue over who is going to get the book. Eventually, whoever wins (or whoever gets it first) should hear the following:

“The instant you touch the book, you feel yourself transformed. Magic words, words for lightning, for water, for fire, for air and for earth, suddenly enter your mind. You also find that your clothing has changed, and that you are wearing a long gown embroidered with fantastic animals and symbols.”

This character really will know the magic words as described. Lightning or fire will send out lightning bolts or fireballs from her fingertips. These are great for wiping out Fegish and Thuhohunk. Air or water magic will send out blasts of air or water. And the word for earth will temporarily heal any stone or broken ground within 20 feet of her. To anyone entering with *Psychic* secret potential, read:



"You enter the castle and see that there's just one room inside. Immediately you notice a brightly glowing object on the wall to your right. There is other clutter in the room, but you only have eyes for the staff that's sitting on a shelf. It is a glowing brightly, especially from the intricate runes and strange writing along its surface. You sense that you are destined to possess it."

If there is more than one **Psychic** in the group, then they'll either have to fight or argue over who is going to get the staff. Eventually, whoever wins (or whoever gets it first) should hear the following:

The instant you touch the staff, you feel yourself transformed. You can feel that you have some strange power. As if you could heal or hurt anyone just by pointing the staff."

The character really can heal or hurt anyone just by pointing the staff. Either the Fegish or the Thuhohunk will flinch and run away any time the character points the staff and wishes to harm them. She'll also be able to cure any of the hurts the other characters may have picked up along the way, including scrapes, bruises and even acne.

To anyone entering with *Princess* secret potential, read:

"You enter the castle and see that there's just one room inside. Immediately you notice a brightly glowing object right in front of you. A dusty old sword stuck in a rock obstructs your view, so you peer around and see the most beautiful crown sitting on a shelf. It's a tiara actually, made of silver, with hundreds of tiny, glittering gems. You sense that you are destined to possess it."

If there is more than one *Princess* in the group, then they'll either have to fight or argue over who is going to get the crown. Eventually, whoever wins (or whoever gets it first) should hear the following:

"The instant you touch the crown, you feel yourself transformed. You place the crown on your head. Suddenly, your ragged clothing changes into a beautiful gown. Your hair is longer and sparkling. You feel taller and more elegant than ever before. You feel the power to command."

The character really can command creatures. Either the Fegish or the Thuhohunk will do exactly as she asks. The other characters will be awed by her appearance, but will not feel driven to obey her.

To anyone entering with *Valkyrie* secret potential, read:

"You enter the castle and see that there's just one room inside. Immediately you notice a brightly glowing sword in the middle of the room. It's sticking out of a huge boulder, somehow reminding you of a storybook tale. The sword is magnificent, with a gleaming blue blade and lovely, blue gems adorning its handle. You sense that you are destined to possess it."

If there is more than one *Valkyrie* in the group, then they'll either have to fight or argue over who is going to get the sword. Eventually, whoever wins (or whoever gets it first) should hear the following:

"As you pull the sword free from the stone you feel yourself changing. Your clothing becomes light, silvery armor. You feel stronger, more powerful. And the sword glows brightly, making humming sounds as you move it through the air."

The character really can wield the sword. Against either the Fegish or the Thuhohunk the character can lop off heads and arms effortlessly.

As soon as the blade is completely free of the stone, the stone will start to break apart.

"You notice that the walls of the castle are crumbling. Like the stone, when the sword was removed, it seems to be falling apart. What are you doing?"

The castle, unless held together by the Mage's Earth spell, will soon come tumbling down. Eventually, when they come out, they'll be met by hostile Thuhohunks, and, later, by the Fegish.

Once armed with any of the artifacts, the girls will have no problem with the Fegish or the Thuhohunk. In fact, when armed with any of the artifacts, the Thuhohunks' true appearance, fanged and ugly, will come out.

Sooner or later, the group should end up back at the sewer grate, in the forest clearing. Any time after the sword has been withdrawn from the stone, the keyhole is ready to be used. As before, the group must recite the chant and insert the key to get to the next stage.

## 9. Rabey

"You suddenly appear in a new place. The sewer grate is still here, still filled with burning coals, but you're standing on a marble circle that's about 20 feet across. The floor seems to be the top of a huge, marble pillar. You can see other pillars rising up around you; perhaps one every half mile in each direction. Looking down, you don't see bottom, just an endless sight of the vast pillars extending down into the distance. You also notice a winged creature flying out of the blue sky toward you. What are you doing?"

It doesn't matter much, eventually the creature will land. The Rabey is immune to any of the artifacts that the characters might have picked up. In fact, it's immune to just about anything.

"An enormous winged creature, it's wings filled with a rainbow of colors, lands on the edge of your pillar. Its body is even larger than the Kroth's, and it has huge claws that dig several inches into the marble. Its eyes are larger than dinner plates, and white with a single fleck of black in each one. It looks at you intently."

If possible, try reading Rabey's speech in a deep voice. In any case, be sure to speak very . . . very . . . slowly . . . That'll get across the idea that Rabey is a little odd. Whenever anyone asks who it is, they'll get the following reply:

"I am Rabey, final gate-keeper of ADABACHEN-RA. You have called me here."

Shortly after the group arrives, Red-Eyes will show up. Read:

"Just now, the guy in the black robe reappears, gesturing at Rabey with his finger-tentacles. The huge creature simply glances in that direction and a shimmering globe appears around Red-Eye. The globe turns slowly, with the man in the black robe struggling inside. You get one last look of the glittering red eyes as he falls over the edge. You notice that Rabey is now looking at you."

From this point on, the challenge to the group will be to prove their suitability to Rabey. If they ask him what he wants, what



he's doing there, or why the player characters are there, he'll respond:

"If you wish to see the divine ASHKENOBISTAR, you must prove that you are suitable. I will determine if you are suitable. You must prove your suitability to me."

Any time someone talks about getting home, or about leaving, Rabey will say:

"If you wish to return to your homes I will grant you that wish. But if you return now, you will *never* again be allowed to see the sublime ASHKENOBISTAR."

Proving the characters' suitability to Rabey may take some time. Every time the group fails, Rabey will respond in one of the three following ways. Which response depends on which best fits the player character's question or statement:

"Although you have achieved much by reaching this point, you have not proven that you are suitable to see the exalted ASHKENOBISTAR. You must prove your suitability to me."

"That is not sufficient to prove your suitability to see the exquisite ASHKENOBISTAR. You must prove to me that you are suitable."

"That, though interesting, is not sufficient to prove your suitability to see the irreproachable ASHKENOBISTAR. I will judge whether or not you are suitable."

Anyone who asks to be returned home, or anyone who disappeared, is out of the game. Eventually the game master will inform them that they find themselves waking up at home. For them it will be the beginning of a new day, and they'll find that they are in trouble for not having done their homework.

So what does it take to prove suitability? Check out the GM's information for specific details. Anyone who remains and proves their suitability will hear the following:

"Very well, you are suitable. You may now see the glorious ASHKENOBISTAR."

At this point the players can once again do the chant, and once again insert the key.

## 10. The Sublime Ashkenobistar

Read the following:

"Once again you are transported to a new place. This time you see a beautiful palace, glittering with gold and jewels. Coming down the red-carpeted steps you see a girl that's exactly your own age. She's wearing the latest fashions and carrying an armful of the latest hit songs on cassette. She says, 'Oh, I've been so bored and I'm so happy to see you here!'"

Ashkenobistar is actually a 13-year-old girl, albeit one with rather special parents and powers. All she's looking for is for friends to have fun with.

## GAME MASTER INFORMATION

Notice that there are no combat attributes or statistics given for any of the beings or artifacts in this adventure? That's because it's for purely Victim characters. The player characters have no chance against the monsters, their best option is simply to run away.

In order to keep the player characters doing the right thing (like running away), it's important to stress their characters.

They are not adventurers, fighters, or psychics. They are simply ordinary 13-year-old girls. And remember, this adventure is designed for *fun*, not bloodshed.

## Suitability

Rabey, the final gate-keeper, determines the suitability of the characters to visit Ashkenobistar. Suitability consists of exactly the kinds of things that 13-year-old girls would consider when determining whether a new girl will fit into their group. All it takes is one player character doing one of the following:

1. Singing a current hit song.
2. Raving about Madonna, or some other current teen idol.
3. Talking about shopping and picking out clothes.
4. Talking about the qualifications they had to meet to get into their own group.

You see, the real challenge is for the players to play **in character**. So long as they remember what's important to their 13-year-old characters, they'll have no problem passing Rabey's test.

## Pronunciation Guide

A final note to the Game Master. If you're going to run this scenario, you'd better spend a little time learning to pronounce the weird names. After all, you'll be expected to read the whole summoning speech *out loud*, and it'll be a lot more effective if you can do it right. Actually, it doesn't matter if you pronounce 'em right, just so long as you pronounce them forcefully. Just as if you knew what you were talking about.

ADABACHEN-RA; Ah – Dah – Ba – Chen – Rah  
ASHKENOBISTAR; Asssh – Kin – Oh – Bees – Tar  
FEGISH; Feh – Gish  
THUHOHUNK; Thu – Ho – Hunk  
FASHERAH; Fah – Sha – Rah  
RABEY; Ray – Bee

The worst two are ADABACHEN-RA and ASHKENOBISTAR. The rest you can fake. Just make sure you can say ADABACHEN-RA and ASHKENOBISTAR as if you knew them personally. Obviously, these are *not* demonic names from mythology; just made-up.

---

# THE RANDOLPH FAMILY MANSION

## Beyond the Supernatural Adventure Scenario

*By Erick Wujcik*

*Thanks to Paul Deckert, Johnny Hill, David Kreher, Kevin Lowry, and John Speck, the original play-testers of this scenario and the original "Victim" version of **Beyond the Supernatural**.*

**NOTE:** This is an adventure for *Victim Characters* or *Regular P.C.C. Characters*. It's designed specifically for any number of player characters taking the roles of members of a single family or P.P.C Psychic Investigators.

## PLAYER BACKGROUND

All the characters should be members of a family who have just settled in to their new house . . .

If characters are being created specifically for this scenario then do the following:

1. Make sure they are all members of the same family. One or more family pets, chosen by the player characters, can also provide some amusing events in the Randolph house.



2. If there are no very young children (preschoolers, under the age of five) among the player characters, make sure you set up at least one youngster as a non-player character. There should be at least five people in the family. If there are even more player characters, so much the better, the house is more interesting if it's crowded with people.
3. The family should be in trouble financially. If they aren't already in the "Wage Slave" category, then implement a little financial reversal that puts 'em in hock.
4. You can also run the adult members of the family through a little preamble where they discover that they're about to lose their old home. Simply Condemn it to make room for a new freeway exit ramp. Their only asset is what's left after the bank takes back its mortgage, a lump sum payment of \$14,000.
5. The only house they can afford to move into, at least the only one that's cheap *and* big enough for the whole family, is the old Randolph Mansion. Although the property is clearly valuable, in the range of \$150,000 to \$170,000, the bank is only asking \$58,000. Even more peculiar, the bank manager will accept any serious offer over \$23,000.

## OPTIONAL MODIFICATIONS

- A. **For a non-family group of Victim characters.** Instead of having the player characters as new residents of the Randolph Mansion, make the building an abandoned structure. Then the player characters can be a group of kids exploring it, or a group of adults given the task of cleaning it out. All the *Phitynic artifacts* should work within 30 feet of the mansion, but will become inert and useless beyond that distance.
- B. **For a regular P.C.C. group of characters.** The player group should be called in as "trouble-shooters" by the bank who owns the property. The building will be uninhabited and the creatures should be more elusive. All the *Phitynic artifacts* should be mysterious and unusable, except, perhaps, by a Psi-Mechanic.

## HISTORY OF THE RANDOLPH PROPERTY

At any point, one of the characters can visit the County Clerk's office and discover some of the following information.

1. The property was listed as being owned by *William Tecumseh Randolph* as early as 1864.
2. The house itself was built in 1908 by the Randolph family.
3. In 1919 the title was transferred to Mrs. Millicent Gloria Randolph.
4. From 1962 to 1964 the title was held by the First Commonwealth Bank.
5. In 1964 the title was bought by Barney and Theresa Zimmerman.
6. In 1975 the title was again transferred to the First Commonwealth Bank.
7. From 1976 to 1984 the title was transferred eight times, each time back to the First Commonwealth Bank. In that time, the Loyola, Krebs, Ackerman, and Young family each owned the house for no longer than four months.

## A ROOM-BY-ROOM GUIDE TO THE RANDOLPH MANSION

### THE GROUNDS

There are three acres of dense woods and badly neglected lawns surrounding the Randolph Mansion. The house itself sits on the center of the southern border, just 30ft (9.1m) back from the road. Outside of the mansion proper there are three remaining out-buildings; the bar, the gazebo, and the shed.

**The Fence:** An eight foot high chain-link fence surrounds the entire grounds of the Randolph Mansion. It's pretty rusty, easy to cut with wire cutters, and relatively easy to climb over. Digging under the fence is difficult since someone has buried another three feet of chicken wire under it as a barrier to rats and moles.

**The Garage:** Formerly a small barn, the building is now converted into a three-car garage. Electrical and gasoline powered devices will have a tendency to randomly turn themselves on and off, *usually* when there's just *one young person* present.

**The Gazebo:** This is an eight-sided structure, usually fitted with screens. The screened sides are all torn open and various vines and vine-like plants have overgrown all the supports all the way up to the roof.

**The Shed:** An old chicken coop, now a run-down shed. Nothing unusual happens here. However, a thorough search will reveal some very strange, small bones.

### FIRST FLOOR

The main floor of the house can be reached from the outside by three different doors. The front door opens directly into the living room. The side door opens into the kitchen, and is also right at the top of the stairway leading down to the basement. The back door opens into the study.

**Living Room:** A large, pleasant room, with a picture window overlooking the front yard. Doorways lead back to the dining room as well as to the stairway leading up. Since this is one of the places where the inhabitants will tend to set up their television, it may turn out to be quite an exciting location.

**Kitchen:** A somewhat cluttered room, with shelves and cabinets everywhere. The kitchen connects with the side door, the door to the dining room, and the down stairway. The appliances have a tendency to turn themselves on and off automatically.

**Study:** Obviously a converted back porch. It can be used as a study, a library, or if the space is needed, as an extra bedroom. There is a door in back to the outside, and one in front to the dining room. The floor is a solid slab of concrete. Occasionally, in the middle of the night, vibrations and low noises can be detected from the floor. This floor also happens to be the roof to the hidden laboratory.

**Dining Room:** A large room, connected to the living room, study and kitchen.

### SECOND FLOOR

None of the rooms on this floor are likely to be very interesting. Briefly, the rooms found here include the **Master Bedroom**, a **Small Bedroom**, and the only **Bathroom** in the house. All have doors that lead out to the stairway landing where one can take the stairs up to the attic, or down to the main floor.



## ATTIC

Filled with dust and grime, the attic has seen very little use over the last fifty years. At the top of the stairs there are two doors, one leading to the bedroom in the front, the other leading to the rear attic storage area. The hidden storage area is well concealed, and will be difficult to find.

**Attic Storage Area:** Just a large, empty space, ready to be filled with the family's junk.

**Attic Bedroom:** A small, cramped bedroom. It also has the only access to the attic's hidden storage area. Whoever ends up living in this room will eventually notice that early morning light leaks through some of the cracks in the east wall. Peering through the cracks gives a view of the hidden area.

**Attic, Hidden Storage Area:** The only way into this area is through the wall of the attic bedroom. The separating wall is a simple frame covered with aging plasterboard. The area contains an assortment of old stored items, starting with three dining room chairs. All the chairs are rickety and break apart easily because their restraining glue has completely dried out.

The next item is an Elephant's Foot Umbrella Stand. It contains two ratty old umbrellas, a crow's head walking stick, Dr. Randolph's spare Phitynic Energy cane (*see Artifact Listing*), and a thick, black tube with a buckled lid on one end. Inside the tube are Randolph's aging drawings, including a full set of architectural drawings of the house itself (a careful examination will reveal the hidden room in the basement). Another set of drawings seem to be for a spherical object; something like a modern, deep water exploration vehicle, and it's labelled as the *Perambulator*.

Even more interesting, especially for any kid characters, is Dr. Randolph's *trunk*. This huge, wood box is filled with all sorts of wonderful books and junk. The printed material includes a collection of rejected manuscripts (scientific journals and publishers all returned his submissions with comments ranging from "ridiculous" to "hogwash"); three, heavy bound journals in a completely unreadable hand, and science books (all dated prior to 1911). *There are four boxes of loose items, containing:* 1) Spent rifle and pistol cartridges, 2) An assortment of glass tubing, jars and beakers, 3) 150 odd nuts and bolts, and 4) a loose rock collection with 38 pieces of oddly shaped granite. Six flat boxes each contain a separate piece of clothing, two formal white shirts; one pair of khaki pants with front, thigh, side, and rear pockets, a brown tweed jacket, a black beret, and a pair of thick leather gloves. Finally, there are five butterfly cases (one of which has something obviously not of earthly origin).

## BASEMENT

The stairs come down directly into the utility room of the basement. There are three large closets along one wall, and the door to the bedroom on the opposite wall. The front wall, directly under the front door, is featureless, and opposite that is the wall where the sink and appliances are kept. The exterior basement walls are all poured concrete, except for the wall behind the utility outlets; that's made of cinder blocks. The wall separating the utility room from the bedroom is a doubled layer of painted plasterboard.

**Utility Room:** Contains combination washer and dryer machines, a large double-sink, and (unless the characters throw it out) an old roller-type washing machine. All the

electrical outlets, and the main circuit breakers for the house power, are all on the cinder block wall behind the washing machines. There is also a drop ceiling in the room. Peering up into it will reveal a small gap (the top of one cinder block) that overlooks the hidden lab.

**Bedroom:** All the walls of the bedroom have been wood paneled to cover up the ugly concrete.

**Hidden Basement Laboratory:** Finding Dr. Randolph's laboratory will be fairly difficult. Possibilities include ripping up a few sections of the basement's drop ceiling and peering over, figuring out the architectural drawings found in the attic, or, after discovering that the study's ceiling is right behind the cinder blocks, attempting some kind of drilling or breaking through. Read the following for anyone who manages to get in:

"The room appears to be some kind of strange laboratory. On the far right there is an old roll-top desk and wheeled chair. To the left you see a large workbench covered with tools. Still, you hardly notice these mundane things, for, suspended in mid-air, and glowing with a weird yellow light, is a huge metal sphere. The sphere seems to be made of copper or brass and is about twelve feet in diameter. Like some fantastic magician's trick, it is simply floating, unsupported, a good two feet off the ground."

The desk is locked but can be opened easily enough with a pocketknife or screwdriver. Read the following if the desk is opened:

"Inside the desk are hundreds of papers, two ledgers, and, currently in use as a paperweight, is a huge pistol. Also, built into the desk, along the back of the desk's surface, is an odd utility box made out of black wrought iron. The box has four old-fashioned electronic switches, one large and three small."

The Webley Horse Pistol is loaded with .620 calibre bullets, and weighs over six pounds. It's a massive weapon, with bullets twice the size of those found in modern pistols. If used, the shells give off an incredible amount of smoke, flash and noise. Obviously, they put huge, messy holes (6D6 damage) in anything they hit. This isn't just a pistol, it's more of a portable cannon. It's also important to note that the weapon is incredibly unreliable, difficult to aim, and with corroding ammunition (spotted with green crud), it will tend to go off by itself if jarred.

All the switches in the control box are currently *off*. Playing with the small switches does nothing. However, if the big switch is moved to the on position, the whole lab will be suddenly moved into *the Void*. Moving the switches after the room is in the *Void* will do nothing.

The sphere is the *Trans-Phitynic Perambulator*. More of a description will be found in the Randolph Artifacts section.

The workbench is covered with ordinary, turn-of-the-century tools, old fashioned electronic devices, and a large (three foot high) jar. Inside the jar is a multi-eyed, multi-tentacled creature floating in a bluish liquid. Also on the bench are two spare *Phitynic batteries*, copper cylinders that can be used as replacements in Randolph's *Effectuator*.

## RANDOLPH MANSION ARTIFACTS

Here's a list of the three important Phitynic Energy items left by Dr. Randolph.



## 1. Phitynic Energy Cane

You can read the following description any time the characters find the cane and examine it closely:

“You see something that looks like a heavy cane. Closer examination reveals some interesting details. First of all, the cane seems to be made up of two long pieces of heavy wood that have been screwed together to form a cylinder some 3ft (0.9m) long and about 2 inches in diameter. The four screws have standard flat head and seems to be made of copper. The head is made of a heavy piece of copper-colored metal, perhaps bronze or brass, and the same material is found at the tip of the cane. The strangest aspect of the cane is the tip. Normally a cane would end in a rubber tip to provide sure footing. This cane ends with a glass ball that rotates freely; a strange property for the tip of a cane.”

Should the characters start playing around with the cane, especially when turning it end over end, they’ll discover the following:

“As soon as you invert the cane you feel it vibrate. Apparently there is some small object that moves slowly *inside* the cane. Turning it completely upside down you find that it takes about 8 seconds for the object to move from one end of the cane to the other. The object will move even when the cane is held at even the smallest angle.”

Disassembling the cane is another possibility. Should the characters decide to undo the screws holding the cane together they’ll find the following:

“As soon as you loosen the last of the four screws a ‘*sproing*’ kind of noise comes out of it. What are you doing now?”

At this point, the cane’s internal machinery has become detached. Attempting to move the cane, duplicating the earlier experiments with the vibrations, results in delicate tinkling noises as tiny glass objects are shattered by a brass ball. Getting the thing open is only possible by removing both the brass end-pieces simultaneously. Then read the following:

“The cane suddenly flies apart, sending tiny springs, wires, balls, and pieces of glass, all over the room. You see that inside the cane there was a winding track made out of long springs, upon which moved a brass ball. Colored pieces of glass in odd patterns apparently bordered the track. Currently, the cane seems completely unusable.”

The cane, assuming it hasn’t been taken apart, can be used either as a pointer or as an energy draining weapon. When pointed toward a source of phitynic energy, the ball inside will move toward the energy, vibrating the cane. If the glass tip comes in direct contact with any of the monsters, it will drain off their energy. This completely dissipates energy creatures and leaves tentacled creatures limp and immobile.

When draining energy, the ball moves back up the cane toward the handle. It is full when the ball is completely at the top, usually requiring at least two, full, energy creatures. The energy can be dissipated from the cane by pointing it down. When the tip is in contact with either the Trans-Phitynic Perambulator surface, or the battery of the Trans-Phitynic Effectuator, the energy will recharge these devices.

## 2. The Trans-Phitynic Perambulator (Sphere)

If the outside is closely examined, here’s what can be seen:

“The entire outside surface of the sphere seems to be made out of brass. It’s smooth, but with little nubs of brass centered in each two foot square of the brass plating, and each nub seems to be tipped with a sharp point of clear glass. The different plates are attached to the body of the sphere with tiny brass nails, set less than an eighth of an inch apart. The only other feature is a round door, or hatchway, again made out of brass, and inset with some kind of green glass. There is just one large hinge, opposite a complicated latch. The latch has a rotary pointer, which can be set for ‘open,’ ‘close,’ or ‘lock,’ and a large handle.”

### A close look inside will reveal:

“The inside of the sphere is jammed with all kinds of dials, levers, and foot pedals. The chair seems to be an old-fashioned leather armchair, and in order to get into it, you have to crawl over all the controls.”

This large spherical vehicle is hidden in the secret basement chamber of the house. Although it is actually the result of an earlier experiment, it can still be used to travel through the *Phitynic Regions*. Its controls are astonishingly complex, especially considering that very few of them are even connected to the drive mechanism in any meaningful way.

- A. Power Switch.** This old-fashioned switch (porcelain handle that rotates from an “on” metal clip to an “off” metal clip) turns the device on. This immediately removes the whole vehicle from existence. None of the rest of the controls will work until this switch is moved. If the port is open, it will immediately feel tremendously cold outside. If the port is closed, the green glass will light up with little circles of all different colors. Viewed from outside, in the lab, the vehicle will simply start to fade away. If the hatch is open, it’s possible for someone to jump in or out in the short time it takes to disappear.
- B. Right Side Foot Pedal.** Pushing this causes all the little circles to move smoothly to the left.
- C. Floor Foot Pedal #1 (Right-most).** Pushing this causes all the little circles to move smoothly upwards.
- D. Floor Foot Pedal #2 (Center).** Pushing this pedal “freezes” whatever circle is near the center and pulls it into a dead-center position.
- E. Floor Foot Pedal #3 (Left-most).** Pushing this causes all the little circles to move smoothly downward.
- F. Left Side Foot Pedal.** Pushing this causes all the little circles to move smoothly to the right.
- G. Main Lever,** with push button mounted on top. Pulling this lever back will cause the circle in the center of the window to flicker. Pushing the button while the circle is flickering will cause the circle to burst like a soap bubble. Actually, this doesn’t really **do** anything.
- H. Secondary Lever,** with dead-man type two-part handle (won’t move unless the two parts of the handle are pulled together). Moving this lever makes the center circle in the window get larger. Continue pulling long enough and the circle will “pop” and suddenly the view out of the window will be of the surrounding area.

Depending on the color of the circle selected, the Perambulator will appear at the corresponding dimension. Moving away from



the new dimension requires turning the power all the way off, and then all the way back on again.

The colors of the circles that appear in the window are pretty much random. Here's a list:

1. White – House
2. White-Pink – Gazebo
3. Pink – Swamp Place
4. Grey – Forest Place
5. Blue-Green – Place of the Glowing Lights
6. Dark Green – The Void
7. Bright Blue
8. Bright Green
9. Bright Red
10. Dull Red
11. Red-Orange
12. Bright Yellow
13. Dull Yellow
14. Reddish Pink
15. Dark Grey
16. Dark Blue
17. Silver
18. Dull Gold
19. Bright Gold
20. Dull Brown

Depending on what possibilities you'd like to make available for the player, you roll different dice. Roll a 1D6, if you want to limit the players to the possible dimensions described in this adventure. If you wish to add more dimensions of your own devising, then roll 1D8, 1D10, 1D12 or 1D20, depending on how many dimensions you've got prepared. You can also describe **all the colors**, but only allow those that are prepared to be reachable by the player characters.

*One last thing about the Perambulator. It will automatically return to the lab if it is left anywhere for more than ten hours. This works regardless of whether or not anyone is inside. The machine will switch itself on, and the characters will have two full melee rounds to get on or off before the machine leaves.*

### 3. The Trans-Phitynic Effectuator

This is a more advanced, *backpack version*, of the Perambulator. This device allows one to travel easily through the dimensions. The only one in existence is on the *dead* body of Dr. Randolph. There are also sketches and design notes on the device sitting on the desk in the lab.

"The hand control seems to be quite simple. There is a rotary control with settings for zero through five, two push-buttons, a circle of green glass and a dead-man style handle."

The Effectuator is built directly into a leather harness/belt apparatus that also contains a ring for the cane, a holster for the pistol, several loops for spare cartridges, and a leather pouch for his log book and pen.

**Working the Effectuator is simple**, just set the dial, press the small button, and pull the handle. The 'zero' setting returns the wearer (and anyone holding onto the wearer) back to the house. Other settings take the Effectuator to other destinations. The large button is an 'emergency stop' that switches off the power.

## POSSIBLE EVENTS

Any time after the characters have moved into the house, it's possible to start initiating some of the following events. To keep the game moving, skip over any 'dead' time, with descriptions like: "It was a normal day, with school, work and play wearing everyone out. Dinner was uneventful, and, afterwards, Mom did the dishes while everyone else watched T.V. It wasn't until Freddie climbed into bed that anything unusual happened."

The following events are just a few of the possible strange things ready to happen in the Randolph Mansion.

1. The youngsters, any kids under the age of six, will quickly attract the notice of the *Energy Creatures*. Very soon the Energy Creatures will be "communicating" with the children, using the television. When any older character shows up, they'll see that the kids are fascinated by a weird piece of static on the screen. When questioned, the kids will simply say that it was "funny cartoons."

Incidentally, for every day of exposure to the Energy Creatures, young kids have a chance of learning some advanced mathematics. Roll 1D20. Any roll *under* the character's I.Q. means they've learned the equivalent of a year's worth of graduate math. After even one successful, roll the kid will be able to correct errors in an older kid's math homework, or in an adult calculation of taxes or bookkeeping. When they've learned five years worth, they'll even be able to communicate directly with the Energy Creatures.

2. Anyone *alone* has a chance of seeing one of the *Tentacle Creatures*. They appear just as tentacles waving around on the ceiling, but will always disappear in a few seconds.
3. Energy Creature *joyrides* can happen any time of the night and day. A few (1D6) Energy Creatures will "possess" some electrical appliances and start exploring their abilities. This usually stops as soon as someone discovers them.
4. After awhile, the Tentacle Creatures will try to be helpful, just lending a *helpful* tentacle to any common household operation.
5. Occasionally, the view out of a window or door, instead of looking out onto the grounds, will look out on one of the other-world dimensions.
6. Eventually, things will start "slipping" over *into* the other dimensions. This can start with simple things ("I just put that briefcase down; which one of you kids moved it?" and "I've heard of socks disappearing, but a whole laundry machine?"). The next to go are pets, who will reappear later with odd pieces of other-worldly debris. Finally, the younger kids may end up following some of their new "friends." Having the kids walk in and out of the television can be particularly disconcerting for the rest of the players.

## EXTRA DIMENSIONAL ENCOUNTERS

Here are *six possible destinations* for travellers using the Phitynic devices:

**One: House** (White Circle or setting "Zero") Either the Effectuator or the Perambulator will always reappear in the secret basement laboratory when they return on the correct setting.

**Two: Gazebo** (White-Pink or setting "One") Another possible return point is the backyard Gazebo. Either the Phitynic Perambulator or the Phitynic Effectuator will "land" in the



center of the gazebo. This can seem a very strange place if the characters haven't cut down some of the vines that covers the building. Incidentally, the Gazebo is also an ideal place if you, the GM, would like to experiment with the possibility of *time travel* using the Phitynic devices.

**Three: Swamp Place** (Pink Circle or setting "Two"): This is where the tentacle things come from. Read the following:

"You are in a swamp, with occasional trees visible all the way out to the horizon in every direction. Underfoot you can see there are pools of water everywhere, with various grasses and vines growing up out of it. Each of the trees has tremendous tangled roots, rising at least five feet above the waterline. The branches of the trees are like those of a willow tree, dangling over the water. There are also plenty of insects, dragonflies, butterflies and brightly colored things you can't even recognize.

"The sky is a strange color, quite unlike anything you've ever seen before; a blue with a touch of pink. And there are absolutely no clouds."

The tentacle creatures (*see description that follows*) are friendly and benign. Although they look frightening, they are merely curious. There are dozens of them lurking below the water level and hidden up in the trees.

#### TENTACLE CREATURES

Tentacle creatures come in a variety of sizes and shapes. Those less than two feet across are the non-intelligent young. The larger ones are intelligent creatures that are incapable of communication with adult human beings.

**Alignments:** Scrupulous and Anarchist

**Attributes:** I.Q.: 2D6, M.E.: 5D6, M.A.: 3D6, P.P.: 2D6, P.E.: 4D6, P.B.: 1D6, Spd.: 2D6

**I.S.P.:** None, the Tentacle Creatures use Psionics without expending I.S.P.

**P.P.E.:** 8                   **Horror Factor:** 14

**A.R.:** 4                   **Hit Points:** 5D6

**S.D.C.:** 20 + 4D6

**Natural Abilities:** Amphibious, so they are equally at home above and beneath the water.

**Attacks per Melee:** 1, by tentacle only, damage is 1D6 per attack.

**Bonuses:** **None for Combat**, +3 against Psionic Attack, +6 against Magic, +8 against Possession, and +10 against Horror Factor.

**Magic:** None

**Psychic Powers:** Astral Projection, Death Trance (Special – Unlimited), Divination, Empathy, Empathic Transmission, Presence Sense, See Aura, Sense Evil.

**Size:** Ranges enormously, but the larger they get the less likely they are to move around much. The players will probably see only the young adults who run from 20 to 120 pounds (roll 2D6 × 10) and have a total tentacle length of 8 to 12ft (2.4 to 3.6m).

**Notes:** Although they don't have much control or understanding of the Phitynic effects that join their world with Earth, the Tentacle Creatures have been able to pierce the barrier. They can "look" through the water into the house, and can occasionally even stick a tentacle through. They can also return people back to the house if they sense a great need.

**Four: Forest Place** (Grey Circle or setting "Three"): This is a barren place, with no life other than that of the plants. It's also incompatible with life from Earth. Read the following when someone arrives:

"You are in the midst of something that looks like an orange pine forest. All the needles on the trees are a sickly yellow-orange in color, although the bark is normal and the plants and grass on the ground are the usual green. Filtering from above is weak sunlight, with a little more yellow in it than there should be. You see no animals or insects, but there's something under one of the trees, about 30 feet (9.1m) away."

That "something" is Randolph's body. If the players investigate, then read:

"Under one of the trees, you discover a man. He's quite still, obviously dead, wearing a tweed suit, in lace-up boots, and with a strange leather harness strapped on his chest and back. Attached to the harness there is one of the glass-tipped canes, an empty pistol holster, and an open leather pouch containing a book of some kind. The man is holding some kind of device in his hand, the device being connected with the rest of the machinery by a stiff insulated electrical wire. On his back, mounted on the harness, you see a cylindrical piece of brass. It has rotary dials on each end, and a plug for the wire. There's a folded piece of paper in the man's other hand."

Should anyone get around to reading the folded piece of paper, here is what it says:

"My dear Mrs. Randolph,

"Millicent Gloria, I fear that I have stranded myself in rather a strange place. Yes, I know, you were right all along. I should never have attempted such an adventure without assistance. But the temptation was too great, and the lack of encouragement from other quarters to scant . . .

"This will be a short letter as I can feel that my fingers are already becoming numb. It would seem that mere mortal flesh cannot survive in this place very long without some kind of support from Phitynic energies. I estimate that my total survival in this place will be no more than three hours. That is simply not enough time for my Trans-Phitynic Effectuator to recharge its batteries.

"Please, dear wife, know that I feel badly for having neglected you. I only hope that my death in such a strange place will not keep us from our final joining . . .

"Yours Sincerely, Madison Randolph"

The Trans-Phitynic Effectuator has recharged itself over the years and is now back in operation. It has enough power for another six trips.

**Five: Place of the Glowing Lights** (Blue-Green Circle or setting "Four"): This is a universe inhabited by beings of pure energy. They are smart enough to have figured out where Randolph came from, and to have learned enough about English to understand others. Here's a description of the place:

"There is nothing here but a horizon that seems way too close. The ground is smooth and shiny, like a pure white marble. Up in the sky you can see thousands of stars, but not white stars. Rather, they are stars colored in a range from pink to red to dark ruby. As you look around, you see that your first impression, that of desolation, is wrong.



The place is actually filled with moving things, but they're all somewhat transparent. One of these things, like a wispy white cloud is very close by and you get the strange feeling that it is looking at you."

Interacting with the Energy Creatures will be difficult because they can't talk back. They understand what is being said but they are only capable of transmitting abstract formulae, something most character's are not equipped to understand. About the only interchange that can take place is the draining of an Energy Creature with the Cane, which will cause all the others to leave. If they are asked, the Energy Creatures will do whatever is asked of them, including returning the player characters back to the house.

## ENERGY CREATURES

These are creatures of pure energy, at home in a different universe where energy is plentiful, but also able to live for short periods on a supply of electrical energy.

**Alignments:** Principled Only

**Attributes:** I.Q.: 6D6, M.E.: 6D6, M.A.: 4D6, P.P.: 1D6, P.E.: Zero, P.B.: 12, Spd.:2D6

**I.S.P.:** 4D6+30 **P.P.E.:** 1D6

**Horror Factor:** None

**A.R.:** 12 (applies to Astral Combat only)

**Hit Points:** 8D6 **S.D.C.:** None

**Natural Abilities:** Astral Travel

**Attacks per Melee:** None, they are extreme pacifists who will not hurt anyone deliberately.

**Bonuses:** +4 against Psionic Attack, +1 against Magic, +10 against Possession, and +2 against Horror Factor.

**Magic:** None

**Psychic Powers:** Their only powers on Earth are Electrokinesis, Levitation, and Pyrokinesis. The Electrokinesis, which normally costs them I.S.P., works differently if they move *inside* an electrical device that's plugged in, then it costs them nothing. Their powers in their own dimension are more varied and powerful, but do not affect humans.

**Size:** They appear to be wispy clouds of vapor, about three feet in diameter.

**Notes:** The Energy Creatures are very intelligent, conversing among themselves in an abstract language of abstract mathematics. They have no concept of fighting or war, and are shocked by some of the things they've discovered by listening in on Earthly radio and television programs. Still, they find Earth to be a "fun" place and will often sneak into electrical appliances, and even gasoline engines for a little taste of "material" life. They are drawn to very young children and will attempt to communicate as if talking to their own young, teaching them abstract concepts of arithmetic and mathematics.

**Six: The Void** (Dark Green Circle or setting "Five"): A place totally unlike Earth. Without an operating Phitynic device, the characters can only survive for a few minutes.

"You can't see anything! You are standing on something that feels like loose gravel, but otherwise you can't see or hear anything. It's a little warm, but there's also a smell here, something like the smell of bacon cooking. You also have the definite feeling that there's someone right behind you."

This region is empty of everything material but the gravel underfoot. There are no creatures here, but the characters will continually "feel" strange presences. Anyone staying here for more than five minutes will start feeling numb at the tips of the fingers and toes.

## CONCLUDING THE ADVENTURE

Here are three possible endings to the Randolph Mansion adventure:

**1. The Big Bang:** The various Phitynic devices gradually start glowing more brightly. They become more difficult to control and the creatures living in the house flee back to their own dimensions. Finally, all the family members are popped back into the house, to the room they originally came from. It's then that the Phitynic rift in the basement starts to glow and vibrate seriously, crumbling the foundations of the house. Just as the family escapes the entire thing blows up. A fitting cataclysmic conclusion to a short-term campaign.

**2. The Weekend Explorers:** This one depends on the willingness of the game master to work up more and varied extra-Phitynic worlds. Just turn this one-shot scenario into a long-term campaign where the Victim characters or the P.C.C.s can explore more distant dimension.

**3. Adventurers of Tomorrow:** In one play-test we did some funny things with time. The adults vanished, presumably destroyed or lost, while the kids survived. Armed with the young ones' advanced math and having managed to save the three Randolph Journals (the ones from the attic), they started doing their own research into Phitynic theory. Fifteen years later, after some quick-time role-playing of the kid's educational years, the parents reappeared. Now that all the characters were adults (except for a couple of older teens), it was possible to have an interesting campaign where all the player characters could participate in the exploration of Phitynic energies and dimensions.

### Time Travel: An OPTIONAL Effect of the Phitynic Devices

**NOTE:** Use of this option depends entirely on the game master. While in the Perambulator, it is also possible to start fooling around with all the dozens of dials and switches that are not part of the main controls. The time period that one arrives in is indicated by the background color of the porthole glass. Medium green, of course, representing our own time.

Percentiles are provided so the game master, if desired, can determine random time travels.

**01-05 Red** – Pre-life Earth, Three *billion* years ago. The air is not good, and characters can only survive about 15 minutes, and there are plenty of earthquakes and volcanoes to keep things interesting.

**06-10 Light Red** – Pre-Colonial Period, circa 1215 A.D. Assuming that the campaign is base in North America, the land will be a wilderness dominated by American Indian societies.

**11-20 Tinged with Red** – 1860. The Randolph house would not yet have been built and the area would consist only of farmland. This is roughly the Civil War period. It would be interesting if the characters were taken for "Yankee" or "Rebel" spies.

**21-45 Clear** – 1909. The Randolph house is one of the only structures in the area. There's still plenty of horse traffic and only the occasional "horseless carriage." At the player's op-



tion, Randolph may still be alive and available for conversations. He would be a rather excitable man, given to stuttering and going off on long theoretical tangents rather than solving practical problems.

**46-60** Tinged with Green – 1926. This is the “Roaring Twenties” era. Things are fairly loose, with lots of cars and people pulling all kinds of strange stunts.

**61-75** Light Green – 1944. The world is in the midst of World War II. Any strangers or strange activity will be immediately suspect since everyone is looking for Nazi spies.

**76-90** Green – The present (1987). Obviously, this puts the characters back where they started.

**91-95** Dark Green – 2002. Just a slightly more advanced version of today. The cars are cleaner, the computers are smaller, and otherwise things won’t have changed a whole lot.

**96-97** Dark Blue-Green – Post-Holocaust, 3127 A.D. Fires burning in the distance and ruins of all kinds everywhere. Suggest you check out the Palladium Book, *After the Bomb* for more details.

**98-99** Light Blue-Green – Super-Civilization. The characters would be immediately imprisoned by incredibly advanced beings. After a short conversation, where the intellects of the future would patiently answer a few simple questions, the characters will be returned to their proper time and place.

**100** Blue – Distant Future Earth, two *billion* years in the future. There is nothing left but mysterious ruins, all made of gigantic crystals glowing with Phitynic Energy.

One of the ways the game master can control rampant time travel, is by implementing the natural limits of the Phitynic devices. Remember, the effect is dependent, like most paranormal effects, on Ley Lines. Therefore, it’s only possible to travel to points in time where (when?) the Ley Line located at the Randolph Mansion is active. That limits all the possible time travel destinations to dates at least *twenty years apart*. In other words, it’s possible to travel from 1987 to 1912, but not from 1987 to 1986.

## A WINDOW ON THE WORLD

### A Beyond The Supernatural Adventure for any P.C.C.

*By Randy McCall*

**Note:** The following scenario has been designed so a game master can use it either as the opening scenario for a campaign, or as an additional adventure for an already established group of P.C.C. characters. The players will not come under attack from much in the way of the occult or magic, but there are lots of terrible physical dangers waiting around every corner. Because of this, the playing group should consist of no less than *6 characters*, unless you wish to *modify the scenario* to give a smaller group a better chance of survival.

In order to give the game master leeway in fitting this adventure into a regular campaign, no location has been given as to where this adventure takes place. Choose your own home town, state, or anyplace else in the continental United States or Canada. The beginning of the scenario has the players driving along a country road at night. If you’re using “A Window on the World” to start a campaign, you can have the individual characters in their own

cars, traveling on the same road, but headed toward different destinations, until fate (the GM, that is) intervenes to bring them together for a greater purpose. Or, if you’re going to slip this adventure into an already established game, the players can be on vacation after a hard job, or on their way to investigate something else until they get distracted (to put it mildly). In either case, there will be NO other cars on the road when everything hits the fan except for the players’ vehicles.

So go ahead and get things rolling. I’m sure you’ll find this piece amusing, and your players will just have a scream!

## PLAYERS’ INTRODUCTION

The hour is late. Very late, almost midnight. Not only is the lateness of the hour bothering your characters, but so is the Road Works Commission, the lovely people who put up the darn detour you’ve been on for the last hour. Bad enough that it takes you off the main interstate and miles out of your way, but it’s taking you across some of the darkest, hilliest and loneliest back-country roads you’ve ever seen. The thought of suffering a flat tire or breakdown here is enough to give even the bravest of you a little shiver.

You feel a little relieved when you see some lights in the distance. At least you’re not the only living souls out here! As you approach, you can see a sign illuminated by spotlights that reads “**Sunshine Wilderness Campground.**” In the woods behind the sign you can see the steady lights of a small building, probably the campground’s office. Dancing in and out through the trees, the characters can see the flickering lights of campfires and propane lamps, with small groups of people sitting around them, drinking, talking and toasting marshmallows.

It’s with a sense of regret that you continue on up the road. It would have been nice to stop for a while, but you have another destination in mind and besides, no one brought their camping gear.

The campground is just fading off into the darkness when suddenly, from behind a hill to your right, there comes a blindingly brilliant flash of multicolor light! At the same moment, a screaming, screeching sound rips through the air like a thousand giant fingernails scraping across a blackboard.

As you try to blink dots of light from your eyes, you realize your vehicle(s) is rolling to a stop; engine dead, headlights out, interior lights dark. Even your radios have gone silent. A glance at your electronic watches show that they too have gone dead, and all at the same moments — exactly midnight.

The smell coming from the engine lets you know, almost before you look, just how bad things are, and a quick visual inspection by the light of the half-moon confirms it. Every major piece of electrical wiring has burned out, the battery is cracked and it looks like the solenoid and the alternator have melted. This baby’s not going anywhere.

It’s then that you hear a low-pitched, all pervasive, throbbing noise coming from the direction of the flash. Looking towards that direction, you see an odd glow with the same strange array of colors as the original flash. A mile or so from the direction you’ve just come from, you can hear the cries of frightened campers echo through the hills, growing louder and much more anxious as they too see this strange phenomenon.



## THE ADVENTURE BEGINS

The burst of energy has burned out all working electrical or electronic devices for miles around, including everybody's cars. Unless the characters have bicycles (and don't mind the idea of riding bikes in unknown, dark, monster infested woods), the only transportation they'll have is by shoe leather. Note, however, that I said WORKING devices were burned out; anything like a flashlight, walkie-talkie, or other *battery* powered systems which were not turned on at the time of the flash will operate just fine.

### Which Way Do We Go?

At this point the players have only two real choices; they can either go directly to investigate the cause of the flash of light, or they can head for the campground. There is one other possibility; run away. But if the characters are going to run away from every strange thing they run across, it's going to be a pretty dull game. Heading down the road back to the camp site is quick and easy; a 30 minute walk or a 15 minute jog (about 2 miles/3.2km). The campers are frightened, but okay. They have no idea about what's going on.

If the characters decide to be brave, bold and resolute and head straight for the source of the light, they'll be plunging into strange woods in the middle of the night with very little to no equipment. The woods will appear dark and menacing, lit only by the light of the half-moon or handmade torches. Odd shapes and shadows are silhouetted against the sky which resemble childhood stories of haunted forests. Suddenly, a shape swoops out of a tree issuing a piercing screech. After everybody's hearts stop pounding they will realize that it was an owl. The woods are full of eerie sounds and movement. Is it a woodland animal or something . . . alien?

During the characters' trek through the nighttime woods, the game master can use the following table to create the proper atmosphere of apprehension. Remember, the characters do not yet know what they are up against.

### Woodland Encounters

- 1-5 Owl hooting.
- 6-10 Bush rustles in a sudden breeze.
- 11-20 Something small and furry runs across a player's foot!
- 21-30 A sleeping bear! With care, it can be avoided without incident. If startled, the bear will attack the first available target.
- 31-40 A glowing pair of eyes is seen in the bushes. The eyes of a wildcat reflecting lights. It will run off if a rock is thrown or the characters get too close.
- 41-50 Insect eating bats start flying around them (though the players won't know they're only hunting insects).
- 51-60 A wild dog howls in the distance.
- 61-70 A short, thin, scream-like squeak is heard off in the distance. Investigation reveals nothing. (Something just killed itself a rabbit, but your players won't know that.)
- 71-80 The wind makes a howling noise as it rushes through tree branches.
- 81-90 The moon is suddenly obscured by clouds, making it more difficult to see.
- 91-00 *Something* large flaps overhead.

**Note:** The general Horror Factor of the woods is about a 10. "Wait! What was that?! Gulp."

So long as the players don't make any tremendously loud noises, like *everyone* screaming at once, or several people firing off guns, they aren't going to have to worry much about attracting attention to themselves. In the event that they do something relatively stupid (and loud), several *creatures* will investigate. The characters may be able to avoid contact with these inhuman scouts as long as they hide and remain quiet. Three will appear to be large humanoids, the size of a line-backer. A careful peek may reveal a thick, four foot (1.2m) tail. A fourth massive, human size or bigger, creature will fly overhead. The beating of its heavy leather wings pounding the cool, night air. If discovered, the creatures will try to capture the characters. If their prey proves to be too troublesome, the creatures will give up. See *G.M. background for details on the creatures*.

Provided the characters are clever enough to avoid any dangerous encounters, not too difficult a thing to do, they will continue moving away from the road and towards the area which is still glowing with light. After about a half-hour of trekking through the woods, the characters will hear the noise of something thrashing through the woods, crashing into trees and through bushes, and headed in their direction. There will be lots of time to plan strategies and take up positions. Whatever's coming isn't moving very fast, just making a lot of noise.

**Game master's note:** Try to build up lots of tension at this point. Make the players sweat a little before you let them know what's going on. Go into a detailed description of the kind of noise they hear, and tell them how large a creature would have to be to make this kind of racket — "Large, at least man-sized." This can be especially effective after the previous close encounter.

Suddenly, a torn and bleeding *human* figure breaks from the woods in front of the characters and starts to dash past them. The man is dressed in the ripped remains of some kind of military uniform. His face is gnarled with a look of absolute horror. If the characters remain hidden, the guy will just keep running, panic-stricken, through the forest, never to be seen again.

Should the characters show themselves, the guy will stop, make a short sound somewhere between a shriek and a sob, then collapse to the ground weeping hysterically. It's going to take the players several minutes of gentle, friendly treatment to settle him down enough to where they can get some kind of rational story out of him.

With eyes averted skyward, only darting down at the slightest noise, the ragtag soldier relates a wild tale. His story is broken by nervous pauses to listen for sounds and to warn characters. "Get DOWN!" "They'll see you. We're safe under cover!" "Get under these trees!" "NO, NO, don't go out in the open, they can FLY!" and so on.

### Jeff's Story

"I'm . . . I'm Corporal Jeff Farnham, Army Military Police. I was stationed out at the Sigma Project; you'll probably know it as Sigma Industries Testing Range. I am . . . I mean was . . . I . . . (sob) . . . a security guard. You may have heard Sigma was testing all sorts of new insecticides and pesticides. God, what a laugh! What a laugh! (giggles uncontrollably)

"But you don't know, do you? How . . . How could you know. They weren't testing bug killers. Sigma's a secret installation for developing new weapons technologies. And they did boy (more giggles). They came up with some good ones! Then



. . . then some bright boy there came up with a whole new weapon, something no one had ever even thought of before. I don't know exactly what it is. I'm not a scientist, but I can tell you one thing. **THEY SCREWED UP!** Screwed up bad. Real bad. (Starts to cry again and will need to be calmed.)

"That gizmo; it brought them here. I know it! I was on guard at the perimeter fence when the blast came. When I picked myself up off the ground and looked, half the staging area building was **GONE!** And there was that damned matrix gizmo still throbbing. Then a hole to Hell opened up at the center of it, and those things started coming out of it. Maybe a dozen. Maybe more . . . I . . . (head hung low) I didn't stay to find out.

"One of the techies grabbed me and said something about cutting off the power. Said it was the only way to stop 'em. But . . . God! I couldn't! I knocked him down and ran. You understand don't you! These **things** are horrible.

"Like out of a nightmare! Some look like the devil himself! And they came jumping out, ripping apart people with their claws. Or grabbing them. And then started **EATING!** God!!! Some of them were still alive and these . . . these things started to eat them. The soldier shivers a moment, then continues speaking in a cold, detached voice.

"Some had wings, while others ran. They had spines and claws and fangs and scales. And they spoke some sort of gibberish I couldn't understand, but what was really horrible was that somehow the sound was almost familiar.

"Listen, we've got to stop them. I was running in panic before . . . But I'm okay now. Sorry. Fear got the better of my training. But I'm all right now. Listen, we had a weapons cache hidden outside the station in case of a terrorist or insurgency situation. All that stuff is still there. We can go back and blow those things back to Hell, or at least close that hole before any more get out. My God. What will happen if more got out. Hundreds, maybe thousands. It would be horrible. We've got to stop them now, tonight! If we wait, they might spread out, and if that hole stays open . . . Well, what do you say? Are you with me?!"

Besides this information, the soldier is more than willing to tell the characters anything else they might want to know (although he doesn't know much more), including drawing them a map of the area and giving them the code to open the weapons cache door. He's afraid that military help will come too late.

## **MEANWHILE, BACK AT THE RANCH**

While the players are trying to figure out what's going on, the gargoyles aren't sitting still. After breaking through and assuaging their appetites, there are still three scientists and a dozen others left alive. The gargoyles have locked them in a storage shed for later dining pleasures. Each of these scientists has the knowledge to shutdown the particle beam generators that have inadvertently opened a dimensional rift. But gargoyles tend to get hungry very quickly.

Depending on when the players encounter the gargoyles, they'll find it anywhere from relatively easy to almost impossible to rescue the scientists and/or shutdown the matrix. The longer the players wait to go after them, the more gargoyles will have

come through the portal. From the point they encounter the soldier (even if he just runs past them) the clock starts ticking. If they arrive within the hour, they will find 2D6 gargoyles and 1D4 gargoyles in and around the base. Another 1D6 gargoyles have already flown off into the world to scout ahead. The others have pillaged the Sigma Station, gorged themselves, and have gone back through the portal to get the rest of their tribe. 1D6 gargoyles (the wingless foot soldiers of the gargoyle horde) will return to our world every hour and wait at the Sigma for the others. At the end of six hours the place will be overrun by hundreds of gargoyles and gargoyles. Fortunately, that's five or six hours away yet.

The handful of gargoyles that remain are quite spread out, so the entry into the complex should be accomplished fairly easily. Although the creatures do not expect trouble, they are a warrior race with keen senses and an alert eye. If anything seems amiss, one or more will investigate. The characters will want to move quickly and quietly through the remnants of the installation.

## **SIGMA STATION**

Sigma Station was a complex of nine flat roofed buildings that resembled those found in most industrial parks. Only the ten foot (3m), barbed wire fence hinted that it was anything else. Now only two of the furthest storage buildings stand completely intact. The other buildings were blown down from the force of the explosion, leaving only an occasional wall standing among the debris field. In the center of the destruction is a giant pentagram, and at each corner of the pentagram is a matrix generator still humming with life. Apparently the force of the blast destroyed everything around it within a thousand feet, but left the pentagram unscathed. Above the pentagram is a doorway to another world. A black, swirling cavity in the center of a whirlpool of colored light.

The solution seems simple: destroy one or two of the generators and the portal should close. The problem is there's a good 1000ft of open space between it and the nearest piece of cover. An attack with automatic weapons will certainly create a ruckus that will capture everyone's attention. It's also quite a distance to hit a four foot by five foot target (1.2 to 1.8m) enough times to knock it out of commission. The ideal situation would be to get in close enough to lob a couple grenades or drill the generators with several rounds of lead. Ultimately, the characters will want to destroy the generators without getting themselves killed in the process.

There is one little surprise too. Destroying one, two or three of the generators isn't enough. As long as *two* continue to operate, the dimensional portal remains open. The underground power system will keep supplying energy until doomsday. It can't be shut off because access to it lays buried under tons of debris.

Freeing the imprisoned hostages is another possibility. All three of the scientists know about the secret access tunnel that leads from the farthest west warehouse building to the power system under the pentagram. At that point, it's a matter of hitting the right switch.

## **THE WEAPONS CACHE**

The weapons the soldier spoke of are hidden in a concealed bunker about a half mile to the east of Sigma Station. The weapons locker contains: Two pump-action shotguns with 10 round, combat extended magazines, each with 30 rounds. Six



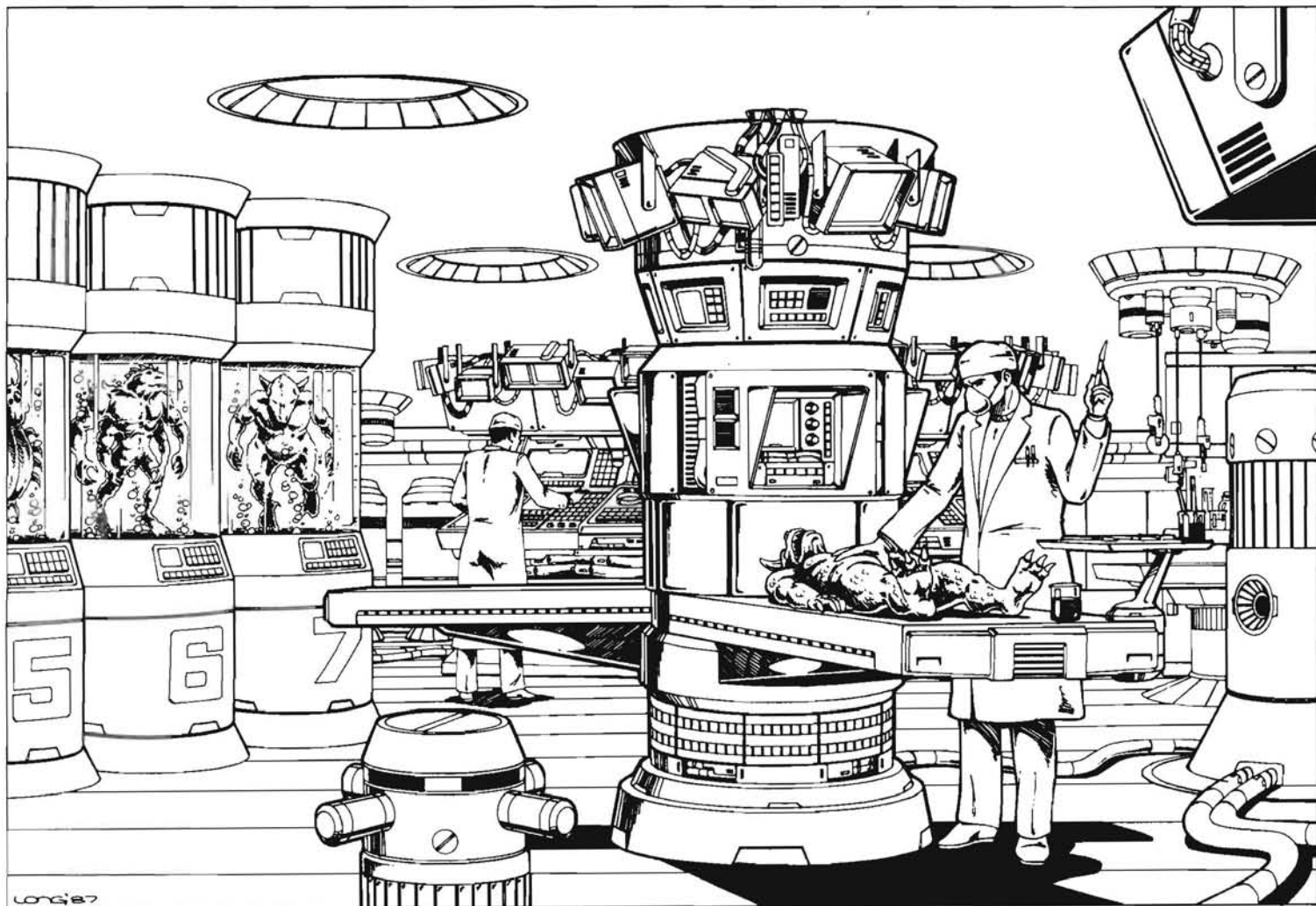

M-16 assault rifles, each with six 30 round magazines loaded with hollow point bullets. Ten Browning GP-35 automatic pistols and holster belts, each belt holding four clips of 13 rounds each, two clips holding normal bullets, one containing hollow point rounds, and one loaded with exploding rounds (with a 35% chance per bullet that it will not explode). A surprise is a single Mark II flamethrower and a satchel of a dozen fragmentary grenades.

The medical locker contains two complete U.S. Army field medical kits, with bandages, sutures, painkillers, stimulants and field operating instruments. There are also 6 walkie-talkie sets, with scrambler systems and headsets with throat microphones built into them. If no one knows how to operate any of the weapons or the walkie-talkies, Jeff can show them.

### Location of the Gurgoyles

- Two sit under the dimensional rift gnawing on bones. A gargoyle circles overhead about every ten minutes.
- One sits on top of the storage shed that contains the captive scientists. Part of a jeep is propped up against the door to keep it shut. However, one of the walls is so badly damaged that three or four men could kick open a hole large enough to crawl through.
- Another gargoyle is exploring the eastern warehouse building.
- The others are prowling the woods just beyond the complex. Any sound of trouble will get them racing back to the portal in a matter of minutes (2D4 minutes).

- Three military helicopters have already been knocked out of the sky by *gargoyles*. The player characters will witness a fourth being destroyed a quarter mile from Sigma.

**Note:** See monster section for detailed descriptions of *Gargoyles* and *Gurgoyles*.

### GAME MASTER NOTES

The military will pull in moments after the characters pull the plug on the power matrix.

Or if the players have gotten themselves into a tight spot, you can have the military arrive in the nick of time to save the day.

After all the destruction, death and trouble it caused, the dimensional portal will snap off like a night-light the instant the generators are turned off or destroyed. There will be no light show or explosion, just a "poof . . . tick . . . bump" and it's all over.

The military troops will hunt down any gurgoyles and gargoyles that may have escaped in the woods.

### THE AFTERMATH . . . A Hint of Things to Come?

The characters will be gathered up, placed under military protection and escorted, under heavy guard, to another underground complex just beyond the western warehouse building. There they will be detained for several days while they undergo extensive questioning and debriefing. It is here that the group



of characters will catch a glimpse of the super high-tech research facility contained within. A facility that looks like something out of a Star Wars movie. At least one of the characters will get a chance to see the research lab marked "Med Lab D." Inside is one of the most advanced medical and surgical research facilities in the world. But it is not the lab that is so fascinating, but the subjects it was designed to study. A medical team hovers over the remains of a gargoyle being dissected, photographed and analyzed in every conceivable way. To the left are seven unusual specimen containment tanks. Each one holds a different inhuman creature.

Right about now it should start to sink in that this military complex is much more than it seems. The giant pentagram, the gargoyle and other creatures (creatures obviously summoned previous to the gargoyle affair), and this whole setup, is not standard military fare. Is somebody trying to intentionally open a gateway to other dimensions? Could the government be considering using supernatural beings as troops against its enemies? These questions will never be addressed.

Shortly after the lab incident, the group will be interrogated by a Doctor Jason Tomblin; a dark haired, brooding man of about 40 years old. It is quickly apparent that he is no novice to the world of the supernatural or magic by the questions he weaves into polite conversation. Doctor Tomblin is a master diplomat who will artfully dodge any questions aimed at him or the Sigma Project. His two assistants are intense young men who will overreact to any aggressive or sudden gestures. One gets the impression they are more likely body guards than assistants.

Psychic or magic sensory probes done on the doctor will reveal the following data.

- 1) High P.P.E.
- 2) Healthy
- 3) At least mid-level of experience.
- 4) Magic energy? Could be.
- 5) Evil? Probably.

After about 4 to 6 days the characters will be released and presented with a brand new-automobile to replace the one damaged in the "incident." Monetary compensation will be provided for any medical treatment and loss of work.

Doctor Tomblin will wave goodbye in between stroking his pet cat.

**Independent research** will reveal the Sigma complex is built on the site of an indian burial ground with a long history of apparitions and unusual occurrences. (Yes, it is a ley line and the dimensional portal just happens to be on a ley line nexus). The area is again off limits, barred by a new wall of fence and barbed wire. Despite the obvious deaths, mayhem and four downed helicopters, the incident never hit the news. Investigation into the man named Jason Tomblin would seem to indicate that no such person exists. There is absolutely no data on this man.

**Game Masters**, Doctor Jason Tomblin is a character that can mean trouble and can crop up over and over again, seemingly involved in occurrences involving magic and dimensional travel.

Jason Tomblin is a 6th level arcanist who is just discovering the sweet taste of power. His alignment is miscreant. And his cat, Raul, is diabolic. Get the picture?



# CITY RUINS

## A Beyond the Supernatural Adventure for any number of regular psychic character classes.

By Kevin Siembieda

“The contemptuous bastards who wear science like a suit of impervious armor insist that there are no ‘monsters.’ I only hope that when some hellish thing crawls out of its hole it grabs one of those popinays. Of course, it won’t happen that way. It will be some innocent fool who put his trust with those men in armor. That’s the way it always seems to be.”

An Excerpt From Professor Victor Lazlo’s  
1973 Address to the American Society of  
Paranormal Study.

## PLAYER BACKGROUND

One evening the characters are alerted by T.V. news coverage of an alleged “drug” shoot out that has left three dead. An all too common occurrence in big cities these days. Then things get interesting. One of the witnesses, a wino, barges in on the reporter’s live “eye witness” report. Before two beefy policemen pull him away, the old man blurts out a very different story, “It weren’t no druggies shooting it out. A monster, it was! Wit fer arms. Them boys found its home an’ it busted ‘em up for it. Kill two before they seen what hit ‘em. Hell yes there was shootin, but bullets don’t do nuthin to the \_\_\_\_\_ (expletive deleted) thing. Now mebe youse do somethin’ ‘fore it kills us all. It’s killin’ us! You hear well. It already got old Frankie, n Lisa n Bob n Angie . . . it go ‘em. An’ that little girl; got ‘er too.” The two policemen grab the old man. “Wha . . . wait . . . it’s killin’ people. When are you \_\_\_\_\_, (expletive deleted) gonna do something?!” The red faced reporter makes a quick apology and switches back to the newsroom for the latest on dental hygiene.

## INVESTIGATION

Nosing through the last few weeks of newspapers uncovers only one item that may hold any significance. A six year old child, Thelma Browne, disappeared from the back steps of the apartment building where the family lives. Neighbors saw and heard nothing. The abduction occurred two weeks ago, about a block and a half from the shoot out. Is this the little girl the old man referred to?

*Snooping around the police* and news agencies draws another big, fat zero. No unusual criminal activity, minimal drug traffic, no gang trouble, and no reports of monsters. Except for the Browne abduction, the streets have been pretty quiet. Heck, to tell the truth, they’ve been quieter than ever. Even characters with the best police or media connections get the same story.

Word on the street is that some “weird shit is going down.” Nobody seems to know what is going on or who might be responsible, but the grapevine says to stay home, keep an eye open and watch your back. That’s about all anybody can tell the characters (because that’s all they know). Several people will suggest talking with the reverend at “the mission.”

The Reverend, Desmond Wilson, is a handsome black man with receding hair and silver temples. He is obviously a warm, friendly fellow who will make time to talk to anybody who shows an interest in his people. He operates one of the city’s few remaining shelters for the destitute and has heard many

things. All kinds of rumors are being spread by the street people, from a psycho-killer to monsters to flying saucers and white slavery. Despite how silly and outrageous these rumors are, the fact is the people are afraid. “Something is happening out there, that much I am sure of. You have to understand that nobody cares about the poor and homeless who wander the city. They are filthy vagabonds, bums, drunken winos, prostitutes, hopped up kids who dropped out of school and rob to put poison in their veins. They are the sewage of the city, so nobody cures what happens to them. Nobody notices when one of them dies or moves on. The people out there are disappearing. I ain’t talking murder, but they are gone, none the less.

The police humor me when I ask for their help. They tell me that these people are transients. That they’ve just moved on to another part of the city or out of the city entirely. But it isn’t true. I’ve taken care of some of these folks for near 15 years now. These streets, this mission, is as close to a home as many of them have had these years. They have friends here. They’re not going to just up and leave without so much as a goodbye. Maybe once in awhile, but I’ve counted eleven of my regulars missing. Some for over five weeks now. That’s not normal.

I’ve checked the other missions and I talked to the others on the street. Nobody has seen them. And I have my ear wired to the street pretty good. These people have to be somewhere.” The Reverend pauses for a moment, then in a tired whisper, asks, “But where gentlemen? They can’t just disappear. Can they?” There is not much more the reverend can tell the characters. He completely rejects the notion of a monster prowling the streets. Kidnapping perhaps? But what would anybody want with these people? However, Rev. Wilson is grateful for the characters’ concern and is willing to assist them in their investigation any way he can.

With Rev. Wilson’s assistance or individual perseverance, the characters can track down the wino from the evening news spot. Louis Garmond can be found in a flophouse that should have been condemned 20 years ago. Nailed to his door are six individual cloves of garlic. He will be hesitant to talk to strangers and will speak only through the door until somebody mentions the Reverend, or the Reverend has accompanied them or if somebody makes a convincing pitch about believing him about the monster and wanting to destroy it.

Louis will be polishing off a bottle of cheap booze, which will help loosen his tongue. If the player characters treat him well, he will tell them everything he knows, which is more than one might believe possible. “They all tink I’m a loony. But I’s got proof. Firstly, I noticed there ain’t no more rats in dem buildings! Can you believe it? In this city no rats. An’ dem all empty buildins are a breedin’ ground for rats.

*Firsthand investigation* of the neighborhood presents a slightly different picture. This part of town is one of the worst in the city, but, even so, its streets are usually alive with panhandlers, rummies, prostitutes and the young and old who have too much time and not enough money. But the character(s) will find the street scene unexpectedly quiet. The few people encountered are



nervous and leery of strangers. Still, it's enough to get a handle of the situation.

"Secondly, Angie disappeared. The pole-lease says she just done go off some where. Hell, they don't give a ..... Well anyway, I went searchin' for her. She yusta sleep in that buildin' across from the Alexandria and Houston Street. Thaws where it is, you know. I couldn't find her, but I found her cat, Cleo. Damned beast's head tore clear off. It was 'bout twenty feet from the body." Louis pauses to wipe the tears from his eyes. He and Angie were old friends. With a gulp of booze, he continues, "So I start keeping my eye on the ol' buildin. An I heard things like stuff being knocked over inside, and once I fell asleep in the alley an' I woke up 'cause I could hear somethin' digging right underneath me. Like a giant rat or somethin."

"Nextly, little Thelma gets taken. I tried to tell 'em where they'd find her, but no one listens. Then those boys run right into it last week. You should a seen it. Big as a grizzly. Tore 'em apart like they was made of straw. I know cause I was sittin across the street watching for it. I tells the police every thin I seen but they treat me like a looney-tune. Damn pigs."

Then Louis makes a startling revelation. "I been in there you know. In the building, this afternoon. The monster lives in the basement, I seen a hole or two. One big one right under the stairs. I'm going back tonight." With that, he brandishes a home-made crucifix, a switch blade, and a 9mm Browning G.P. 35. "I picked up this momma as a souvenir from the creature's fight wit the drug boys. Just needed some juice to build up my courage, eh." With that, he staggers to his feet, tucking away his pitiful arsenal, exclaiming: "You boys in fer the fight or no?"

Any attempts to convince the old man will fall on deaf ears. Finally, he shouts, "You don't understand! The girl is still alive! Thelma, I heard her cryin this afternoon, only I was too sober to go in an' git her. Well I'm ready now!"

## GAME MASTER INFORMATION

Obviously, good old Louis thinks he's fighting vampires. It has taken him eight hours and three bottles of hooch to get up enough nerve to try to save the little girl. Consequently, it will take a lot to convince him to do otherwise or even wait. "Iffen we wait, them creatures will turn her into one of them." Louis has seen too many scream-shock-horror, theatre late night T.V. shows. However, his point is well taken, in that the girl's life is hanging by a thread. It is a miracle that she is still alive.

Let the players figure out what they are up against. The comment about *four arms* and hearing it *digging* underground should tip them off that they are dealing with a *Dybbuk*. If they guess wrong or don't know, that's okay too.

At this point, it is up to the game master to resolve the scenario quickly or to turn this into a longer running episode, perhaps even stretching into two or three separate adventures.

**The short version** will have the group find the girl and destroy the dybbuk. Exactly how difficult or easy a task that might be will depend on the character's combined skills and abilities, and the player's ingenuity.

**The Long Version** should probably go something like this. The group goes to the dilapidated building and finds the tunnels, just like Louis described. The immediate problem is which tunnel should they enter? There is a big tunnel opening under the stairs

and another about 60ft away (18.3m). Are they connected? Which one is the Dybbuk in? Is it even home? Crawling through the tunnels will require light and stealth. Fortunately, these are man-sized passages. After much fearful anticipation, they find the girl, half starved and terrified, but alive. Whether they fight the dybbuk on the way out or not is up to the individual game master. Let's assume they do not encounter the demon ghoul. The girl is safe, but the problem is very much alive. Characters of a good alignment will be compelled to return soon, and destroy the vile monster before anyone else falls victim to it. This of course, sets things up for the big battle. The eventual confrontation should lead back to the tunnels, where the creature will try to escape. The characters will find that the tunnels are much more extensive than they first believed. One passage leads to the derelict building next door, another to the alley and a third goes all the way down the block, exiting behind a trash dumpster. The battle should have its moments of suspense and action, culminating in the final battle.















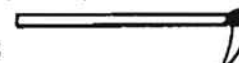

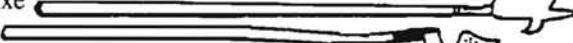



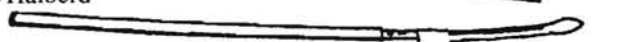
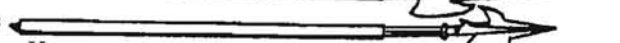

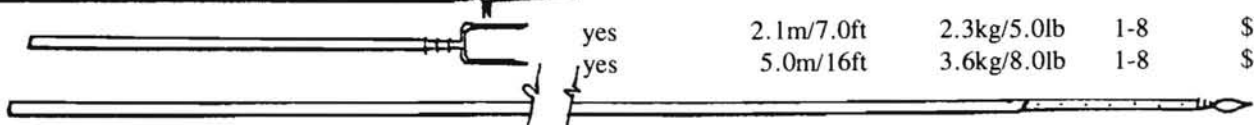
The creature destroyed, the group returns topside to mend their wounds and relax, knowing that they have proven victorious over evil. But is the saga over? Again, it is up to the game master. A possible continuation might go like this.

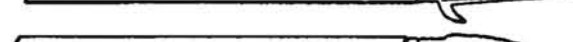
A week or two after the battle with the dybbuk, one of the characters get a call from the Reverend Wilson. Louis has been missing for the last three days. The players know that the characters killed the dybbuk, so what could be going on now? Going to speak to the Reverend and re-examining the tunnel dwelling, the characters see the familiar form of Louis scrounging in a garbage can. "Missing? Shit, I just left the mission not two hours ago. Bin there all day." What's going on? Why would the good Reverend lie to them. One possibility is that the first dybbuk was not alone. There were two of them. And even though they hated each other and fought constantly, the second dybbuk has sworn to avenge its fellow's death. But how could it have coerced the Reverend into making that call? The reverend would die before he betrayed a soul. If the demonic creature killed the reverend it could possess his body, but it would not gain the Rev. Wilson's memory. So how could it find the phone number? Futhermore, how would it have connected the Reverend with them? Suddenly, it dawns on them. The reverend *did* call. Louis *has* been missing for the last three days. Louis smiles and adjusts his jacket momentarily, revealing the strangle marks and scratches on his throat. The question now is whether the dybbuk that inhabits Louis' corpse recognizes the characters and craves revenge. Or whether the creature is trying to disguise itself to more easily walk among its prey and only desires to escape. The story continues . . .





















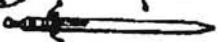
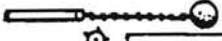

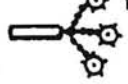
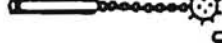



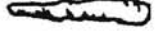

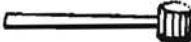



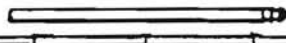
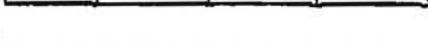
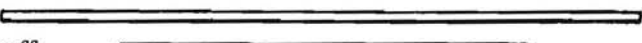
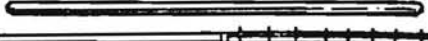

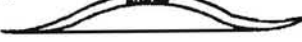
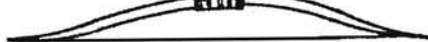

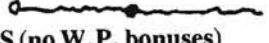



## ANCIENT WEAPONS

Type	2-Handed	Avg. Length	Avg. Weight	Damage	Avg. Cost
<b>AXES</b>					
Axe, Battle 	no	.8m/2.75ft	2.0kg/4.6lb	2-12	\$240
Axe, Throwing 	no	.4m/1.25ft	1.4kg/3.0lb	1-6	\$100
Axe, Stone 	no	.6m/2.0ft	1.8kg/4.0kg	1-8	\$100
Axe, Bipennis (2-head) 	no	.8m/2.75ft	2.8kg/6.0lb	2-12	\$120
Oncin Pick 	yes	1.0m/3.75ft	1.8kg/4.0lb	1-8	\$220
<b>POLE ARMS</b>					
Awl Pike 	yes	3.2m/10ft	2.7kg/6.0lb	2-12	\$445
Beaked Axe 	yes	2.3m/7.5ft	2.3kg/5.0lb	2-12	\$540
Berdiche 	yes	2.1m/7.0ft	3.2kg/7.0lb	2-12	\$550
Glaive 	yes	2.3m/7.5ft	2.7kg/6.0lb	2-12	\$540
Guisarme 	yes	2.5m/7.25ft	2.7kg/6.0lb	2-12	\$550
Halberd 	yes	2.2m/7.25ft	2.3kg/5.0lb	3-18	\$660
Sabre Halberd 	yes	2.4m/8.0ft	3.2kg/7.0lb	3-18	\$650
Hippe 	yes	2.3m/7.5ft	2.7kg/6.0lb	3-18	\$750
Lucerne Hammer 	yes	2.9m/9.75ft	2.9kg/6.5lb	2-12	\$540
Military Fork 	yes	2.1m/7.0ft	2.3kg/5.0lb	1-8	\$330
Pike 	yes	5.0m/16ft	3.6kg/8.0lb	1-8	\$445
Runka 	yes	2.3m/7.5ft	2.7kg/6.0lb	2-12	\$445
Scythe 	yes	2.4m/8.0ft	2.3kg/5.0lb	1-8	\$445
Voulge 	yes	2.1m/7.0ft	2.3kg/5.0lb	3-18	\$550
<b>SPEARS</b>					
Short Spear 	no	1.2-1.8m/4-6ft	1.8kg/4.0lb	1-6	\$130
Long Spear 	yes	2.1-3.0m/7-10ft	2.9kg/6.5lb	1-8	\$180
Javelin 	no	2.1m/7.0ft	1.8kg/4.0lb	1-6	\$180
Beaked Axe 	no	1.4m/4.5ft	2.3kg/5.0lb	1-8	\$430
Trident 	yes	1.5m/5.0ft	1.8kg/4.0lb	1-8	\$240
Lance 	no	4.0m/13ft	3.6kg/8.0lb	1-8	\$460
<b>KNIVES</b>					
Daggers and Knives 	no	.2-.5m/10-20in.	.5kg/1.0lb	1-6	\$30-100

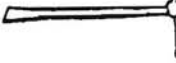

Type	2-Handed	Avg. Length	Avg. Weight	Damage	Avg. Cost
<b>SHORT SWORDS</b>					
Short Sword 	no	.7m/2.5ft	1.4kg/3.0lb	1-6	\$240
Sabre 	no	.6m/2.0ft	1.4kg/3.0lb	1-6	\$230
Scimitar 	no	.7m/2.5ft	1.5kg/3.5lb	1-6	\$235
Falchion 	no	.8m/2.75ft	1.8kg/4.0lb	1-8	\$350
Cutlass 	no	.6m/2.0ft	1.4kg/3.0lb	1-6	\$235
<b>LARGE SWORDS</b>					
Bastard 	yes	1.0m/3.75ft	2.1kg/4.5lb	1-8 + 2	\$450
Broadsword 	no	.9m/3.0ft	1.6kg/3.5lb	1-8	\$340
Claymore 	yes	1.2m/4.0ft	2.9kg—6.5lb	2-12	\$560
Flamberge 	yes	1.3m/4.25ft	3.4kg/7.5lb	3-18	\$670
Long Sword 	no	.9m/3.0ft	1.6kg/3.5lb	1-8 + 2	\$455
2-handed Espandon 	yes	.9m/3.0ft	2.1kg/4.5lb	2-12	\$460
<b>BALL and CHAIN</b>					
Ball and Chain 	no	.9m/3.0ft	2.1kg/4.5lb	1-8	\$250
Flail 	yes	1.6m/5.25ft	2.5kg/5.5lb	2-12	\$355
Goupillon Flail 	yes	.5m/2.0ft	2.1kg/4.5lb	3-18	\$460
Mace and Chain 	no	.9m/3.0ft	2.1kg/4.5lb	2-12	\$280
Nunchaku 	yes	.8m/2.75ft	1.1kg/2.5lb	1-8	\$30
<b>BLUNT WEAPONS</b>					
Arab Mace 	no	.6m/2.0ft	1.4kg/3.0lb	1-8	\$240
Mace 	no	.7m/2.5ft	2.0kg/4.5lb	1-8	\$240
Cudgel 	no	.8m/2.75ft	1.0kg/2.5lb	1-8	\$240
Club/Stick/Pipe 	no	.8m/2.75ft	1.4kg/3.0lb	1-6	\$10
Hercules Club 	yes	1.2m/4.0ft	2.5kg/5.5lb	2-12	\$260
Horseman Hammer 	no	.8m/2.75ft	1.6kg/3.5lb	1-8	\$145
Maul 	no	1.2m/4.0ft	2.0kg/4.0lb	1-6	\$100
Morning Star 	no	.8m/2.75ft	1.0kg/2.5lb	1-8	\$240
War Club (wood) 	no	.9m/3.0ft	1.4kg/3.0lb	1-6	\$75
War Hammer 	no	.7m/2.5ft	2.1kg/4.5lb	1-8	\$190
<b>STAVES</b>					
Short 	no	1.2-1.8m/4-6ft	1.4kg/3.0lb	1-6	\$120
Long 	yes	1.9-2.7m/7-9ft	2.3kg/5.0lb	1-8	\$125
Bo Staff 	yes	2.8m/9.5ft	1.4kg/3.0lb	1-8	\$140
Quarterstaff 	yes	1.8m/6.0ft	1.5kg/3.5lb	1-8	\$130
Iron Staff 	yes	1.8-2.1m/6-7ft	3.2kg/7lb	1-8 + 2	\$245
<b>MISSILE WEAPONS</b>					
Short Bow 	yes		1.0lb	1-6	\$130
Arrows	no				\$20/dozen
Long Bow 	yes		2.0lb	2-12	\$270
Arrows	no				\$40/dozen
Cross Bow 	yes	Range: 500-700ft	7.0lb	1-8	\$160
Bolts 	no				\$35/dozen
Sling 	no		2.0oz.	1-6	\$40
<b>MISCELLANEOUS (no W.P. bonuses)</b>					
Black Jack 	no	10in	1.4kg/3.0lb	1-4	\$10
Dart 	no	6.0in	6oz.	1-4	\$2
Bull Whip 	no	2.4m/8.0ft	1.4kg/3.0lb	1-8	\$60
Cat-o-Nine Tails 	no	.8m/3.0ft	.5kg/1.0lb	1-6	\$100
Meat Cleaver 	no	.3m/1.0ft	.5kg/1.0lb	1-6	\$10
Frying Pan 	no	.3m/1.0ft	.5kg/1.0lb	1-6	\$10
Hand Pick 	no	7.0in	8.0oz.	1-4	\$5
Large Pick/Mattock 	yes	1.2m/4.0ft	2.3kg/5.0lb	1-8	\$50
Shovel 	yes	1.2m/4.0ft	2.0kg/5.0lb	1-6	\$40
Hammer (tool) 	no	10in	1.4kg/3.0lb	1-4	\$10



## ANCIENT ORIENTAL WEAPONS

### ANCIENT WEAPON DESCRIPTIONS

#### Aikuchi/Tanto

These are curved Japanese daggers. The Tanto has a hilt, the Aikuchi does not. This weapon can also be thrown. **Cost:** Varies according to quality and beauty, from \$20 to \$1,000. **Damage:** 1D4.



#### Bisento

This spear features a broad, curved blade and is large enough to be considered a kind of pole arm. This weapon must be imported from Japan. **Cost:** \$600. **Damage:** 2D6.



#### Blow Gun

The blow gun is a favorite weapon of the ninja. Effective range is no more than 50ft. **Cost:** \$45.00. **Damage:** The dart itself does no damage; however, it is usually coated with poison or drugs.

#### Bo Staff

Although staff weapons have appeared in virtually every culture worldwide, the techniques of use were probably most advanced in the martial arts schools of samurai Japan. The size of the Bo Staff should be about a foot taller than the height of its owner. **Cost:** \$120. **Damage:** 1D8.

#### Bows

Ninjas favored a short, none too powerful, bow that could be disassembled and easily hidden. A separate skill learned by the ninja is that of the Samurai Long Bow, probably the most powerful weapon of its type in the world. Effective range for the ninja bow is 400ft, for the samurai bow it is 800ft. **Cost:** \$500 for ninja bow, \$1,000 (or more) for a high quality samurai bow. Modern commercial hunting bows cost: \$200. **Damage:** 1D8 — Ninja Bow, 2D6 — Samurai Bow, 1D10 — Modern Bow.

#### Crossbows

Crossbows are now commonly available by mail order in the U.S. **Cost:** \$300 for heavy crossbow, \$150 for pistol style crossbow. **Damage:** 2D6 for heavy, two-handed crossbow; 1D10 for 40lb, *pistol style* crossbow.

#### Daisho

Literally, "the long and the short," this is the traditional Japanese weapon made up of a Wakizashi and a Katana which

can be used as paired weapons. Using both of these weapons together is a separate skill. **Cost:** As little as \$150 for fair quality and \$1200 for an authentic high quality. **Damage:** 1D8 + 2 (long), 1D6 (short).

WAKIZASHI  
SHORT SWORD

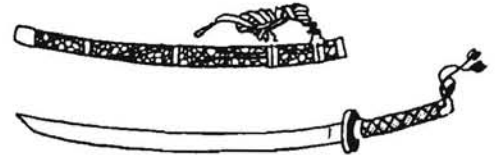

KATANA  
LONG SWORD

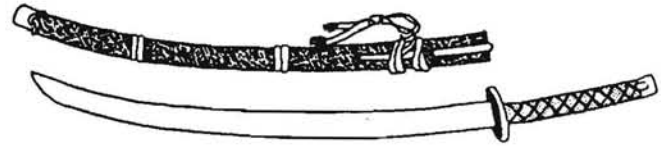

#### Jitte or Sai (Paired Weapons)

These weapons look like oversized, three-pronged forks and are generally designed to be used as a pair, one in each hand. They are excellent for countering the massive attack force of the samurai sword blade. A skilled user can entangle an opponent with one hand and attack with the other. **Cost:** \$50/pair. **Damage:** 1D6.

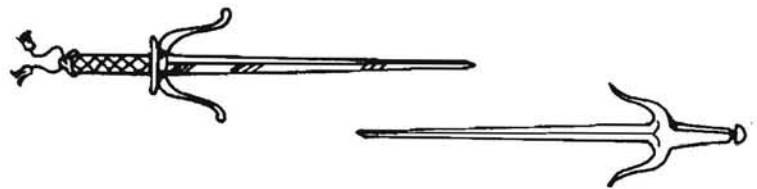

#### Katana

This is the primary weapon of the Samurai warrior; a long sword up to 3ft in length. There is an enormous difference in the quality of these weapons. **Costs:** For manufactured versions could be as little as \$300. A top quality sword could cost at least \$5,000. **Damage:** 2D6 for regular quality, 3D6 for top quality (authentic).

#### Kusari-Gama/Kyoketsu-Shogi

The combination of a chain with a weight on one end and a sickle weapon on the other is another ninja favorite. The Kyoketsu-Shogi is made with rope and has an iron ring on one end and a double blade on the other. With both weapons, one end can be used for an entangle while the other is still available for striking. It is usually used as a climbing device, but doubles



as a somewhat less damaging Kusari-Gama. Neither of these weapons can be used by anyone not trained in hand to hand martial arts, assassin or ninjitsu. The Kyoketsu-Shogi costs \$100, the Kusari-Gama is \$300. **Damage:** 1D8 for the Kyoketsu-Shogi, 1D10 for the Kusari-Gama.

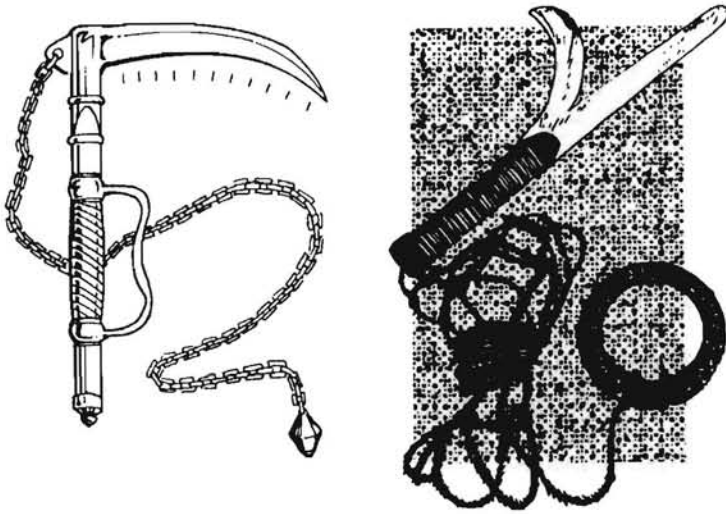

### Kawanga

Ninja combination of a rope and grapple used for climbing and fighting. This is a separate chain weapon. **Cost:** \$50. **Damage:** 1D8.

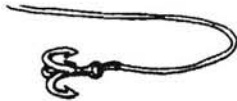

### Manriki-Gusari

Chain weapon with solid, blunt weights on each end. It can be used like a Kusari-Gama, entangling with one end, striking with the other. This is a weapon which is easy to disassemble and conceal. It is also easy to make a Manriki-Gusari from a length of chain and lead weights found in any hardware store. **Cost:** \$30. **Damage:** 1D8.

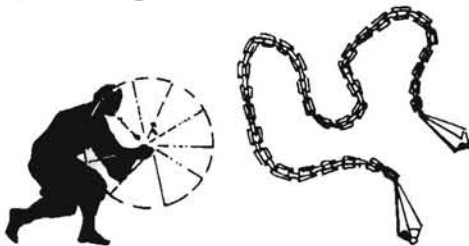

### Naginata/Yari

Naginata have curved blades and Yari have straight blades. Otherwise, both of these weapons are alike and used as spears. They are very difficult to conceal. **Cost:** \$150. **Damage:** 1D8.

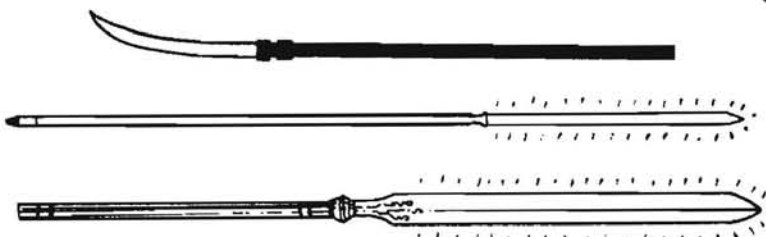

### No-Dachi

This huge two-handed sword does much more damage than most weapons in its class. 5 to 6ft long and carried on the back, the weapon is pulled from the scabbard over the shoulder. **Cost:** \$750 and up. **Damage:** 3D6.

### Nunchaku

Nunchaku (usually called "Numchuks") can be used as a paired weapon for striking. One of the main advantages of Nunchaku is for entangle and this can only be done if one weapon is used with two hands. **Cost:** \$30 each. **Damage:** 1D8.

### Sa Tjat Koen

This Malaysian weapon looks like Nunchaku with a second chain and third handle attached. Can be used to entangle like nunchaku. Can *not* be used as a paired weapon. **Cost:** \$150. **Damage:** 1D10.



### Shikomi-Zue

Ninja commonly disguised themselves as blindmen and carried this hollow bamboo staff with a concealed blade. The blade is spring loaded, and the release is controlled with a trigger stud that can be pressed or turned. Weapon can be used as a somewhat fragile (S.D.C. 50) Bo Staff or as a spear. **Cost:** \$150. **Damage:** 1D8.

### Shuriken

The famous "throwing stars" of the ninja were not designed for deadly effect so much as for their ease of concealment and usefulness in discouraging an opponent's pursuit. Throwing knives requires a different technique than shuriken. **Cost:** High quality shuriken are \$5.00 each, high quality throwing knives are \$3.00 each. **Damage:** 1D4.

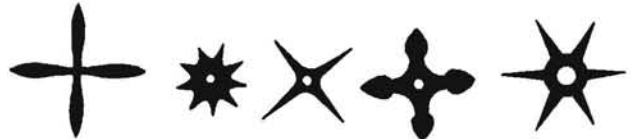

### Wakizashi

This is the short sword favored by the samurai. The ninja short sword has a straighter blade, but it is otherwise just like a wakizashi. **Cost:** Varies according to the quality (see Katana for prices). **Damage:** 1D8 for regular quality, 2D6 for top quality.

### Tonfa

A short wood weapon ideal for parrying and close combat. **Cost:** \$40. **Damage:** 1D6.

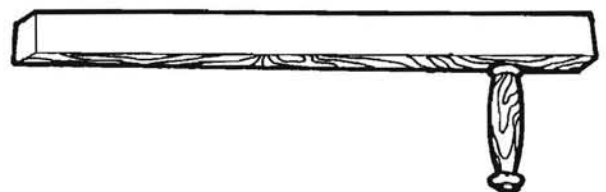



## NINJA EQUIPMENT

The Ninja have developed a number of specialized tools and weapons to aid their missions. These weapons are often provided by Ninja organizations or built by the Ninja himself. Ninja equipment is generally not commonly available to the public.

**Climbing Claws:** Also called Tekagi or Shuko. There is usually a metal or leather band that wraps around the palm between the thumb and fingers. The inside surface has from two to six spikes that are helpful in climbing wood and stone surfaces. Adds +15% to climbing skills. **Cost:** \$85/pair.

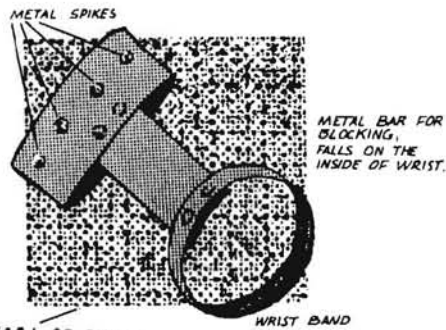

TEKAGI OR SHUKO

USED AS A CLIMBING TOOL AND WEAPON  
DAMAGE RATING: 1

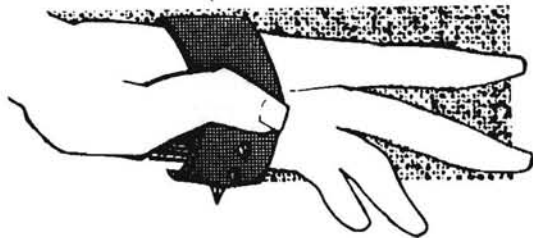

**Climbing Spikes:** These are spiked claws that are attached to the soles of the feet for climbing. Note that normal walking or running is impossible while wearing these. Add +15% to climbing skill. **Cost:** \$45/pair.

**Eggshell Bomb:** This is an eggshell filled with pepper, metal shavings and other secret substances. When tossed, it will shatter and a small cloud of blinding, irritating smoke will come out. Does no damage, but all victims must save against poison gas. **Cost:** \$5.00 each. Blinded victims are -6 to strike, parry and dodge.

**Ippon-Sugi Nobori:** A special tool used ONLY for climbing trees and telephone poles. A short length of spike-studded wood with ropes attached to each end. This is used much like a lumberjack's or lineman's leather climbing belt. Add 25% to climbing skill. **Cost:** \$25.

**Ninja Emergency Kit:** This is an assortment of items that a Ninja might need in case of trouble. Ninjas will keep several of these kits hidden in various places. Included in a small cloth bag would be a Kyoketsu-Shogi, 6 Shuriken, 12 Caltrops, a 3ft towel, a small cooking pot, paper and pencil, matches, first-aid kit (bandages, disinfectant, small scissors, painkiller), lock picks, spare clothing, and an eggshell filled with blinding powder. Enough rice, soybean curd and tea would be included for 7 days of tight rations. **Cost:** \$120.



**Ninja Clothing:** Comes completely black for concealment in darkness or completely white for snow. Consists of jacket, hakama (pants), tabi (socks), and belt. Leggings, and separate sleeves fitted from elbow to back of hand, a groin protector and a body protector are made out of quilted padding and used as protection. There are numerous pockets and compartments used to conceal shuriken, garrote, caltrops, lock picks and other Ninja items. **Cost:** \$600.

**Rope and Chain:** Available in just about any hardware store. Modern rope and chain is usually well tested and reinforced. Cost varies according to thickness and tensile strength. **An average cost** for chain would be about \$1.00 per foot, about \$.25 per foot for rope.

**Rope Ladder:** This Ninja rope ladder has loops knotted into it every two feet or so (depending on the height of the owner). There is a 3 pound weight attached to the bottom end. The top end is often tied to a grappling hook. This item is easy to use and easy to conceal. **Cost:** \$.75/foot.

**Tetsubishi:** Ninja caltrops come in a variety of styles. All are designed so that metal barbs will point upwards no matter how they land on the floor. Damage is rarely more than 1 point, but someone with a caltrop in their foot isn't likely to continue walking until they pull it out. **Cost:** \$2.00 each.

## OTHER ANCIENT EXOTIC WEAPONS

**African Throwing Knives:** **Cost:** \$80-\$150. **Damage:** 1D8.

THROWING IRONS

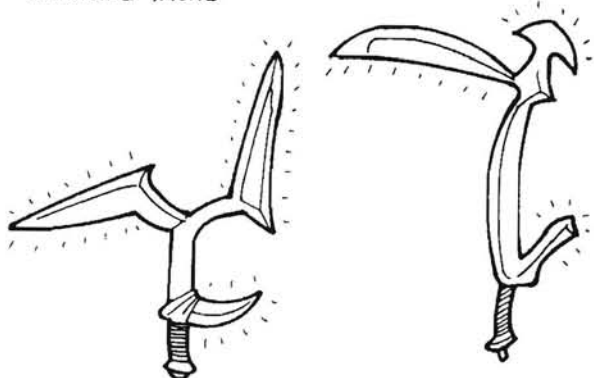



**Bola:** Two or three heavy balls attached to a long cord used primarily in South America to *entangle* cattle. **Cost:** \$40. **Damage:** 1D4.

**Boomerang:** The infamous aborigine throwing stick. **Cost:** \$10-\$20 each. **Damage:** 1D6.

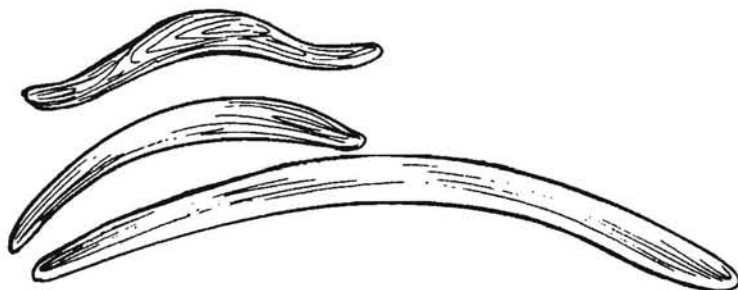

**Chakram:** A flat steel ring with a sharpened outer edge. **Cost:** \$10 each. **Damage:** 1D4.



**Katar:** A Hindu double blade weapon that might be thought of as a small sword, usually about one and a half feet long. **Cost:** \$200. **Damage:** 1D6.

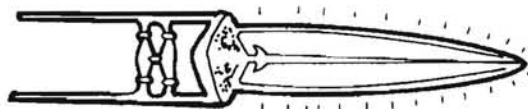

**Tiger Claws or Bagh Nakh:** A small set of steel claws that fit in one's hand. A weapon favored by assassins in India and the Middle East. Tiger claws were often combined with knives (Bich'Hwa Bagh Nakh). **Claws alone Cost:** \$40. **Damage:** 1D4. **Claws and blades Cost:** \$70 to \$150. **Damage:** 1D6 knife, 1D4 claw.

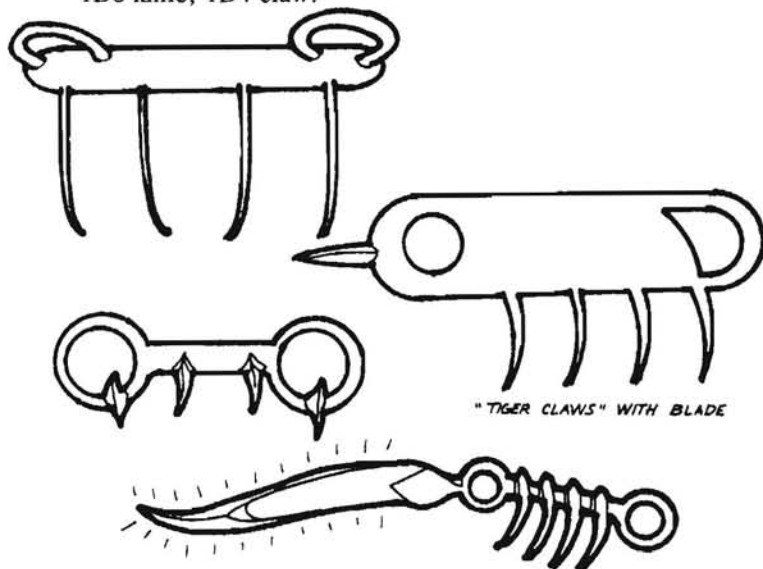

"TIGER CLAWS" WITH BLADE

# WEAPONS

## NOTES ON MODERN CONVENTIONAL WEAPONS

**Explosives:** Most hand grenades should be treated as thrown weapons. Grenade launchers are used as Weapon Proficiency - Rifle. See equipment section for more information.

**Reloading:** Almost all modern weapons come equipped with easy-to-load clips (magazines). There are even quick-loaders for revolvers. This means that attackers can fire a full clip every melee. However, older weapons (bolt-action, muzzle-loaders, hand loaded revolvers) and most shotguns will require a full melee round (or more) to reload. Note that it will take much longer to reload while in the thick of hand to hand combat.

**Effective Range:** This is the longest distance that the weapon can be fired without losing accuracy or damage. Guns can be fired beyond their effective range, but with no W.P. Skill Bonus and with a -4 to strike for every 25 feet beyond the effective range.

**Moving Targets:** It is a lot harder to hit someone while they are moving. -3 to strike at moving, running or leaping targets. -6 to strike anything speeding 40mph or more.

**Strike Bonus:** Physical Prowess (P.P.), Physical Training and other strike bonuses *Do Not Apply* to modern weapons. When using a gun, only the W.P. Skill bonuses with that weapon can be used. For example, a character with +5 to strike in hand to hand combat and level 1 skill in revolver would have a +3 *Bonus to Strike* for an aimed shot.

## TISSUE DAMAGE RATING

Since the major factor in the damage of a particular weapon is the type of shell used, we have developed a Damage Rating based on the cartridge types. The cartridges listed are considered the most common and universally used.

The tissue damage indicates the suggested amount of damage (dice) caused by a particular weapon. This is by no means a definitive evaluation of its effectiveness in the real world. However, it is what we believe to be an acceptable translation of effectiveness to role-playing games. Those of you who have firsthand knowledge to believe otherwise, feel free to adjust these ratings as you see fit. Game masters, you should not be intimidated by a player who swears that these ratings are not accurate. If you are comfortable with these ratings then stick to them, or do some research to confirm them. We are personally confident that the rating system is a fair and reasonable adaptation.

### TISSUE DAMAGE RATINGS

Damage Rating	Tissue Damage
1. Barely Adequate	1D6
2. Fair	1D8
3. Good	2D6
4. Very Good	3D6
5. Excellent	4D6
6. Very Excellent	5D6
7. Superior	6D6
8. Heavy Machinegun	5D10+6
9. Heavier Calibre Machinegun	6D10+6

(Both 8 and 9 will shoot through a car's engine block)



## PENETRATION VALUES (other than tissue)

1. Poor: Deflects off bone.
2. Fair: Deflects off bone.
3. Adequate: May lodge in bone.
4. Good: May break bone.
5. Very Good: Shatters bone, wood; goes through cinder block.
6. Excellent: Shatters bone, wood; goes through ½ inch armor plate steel.
7. .50 Calibre: Goes through brick, thin metal.

**Note:** Numbers in front of cartridge names indicate the **Tissue Damage Rating** from the above table.

## PISTOL CARTRIDGES

- (1) **.22 Short:** Very little penetration. Little or no nerve trauma.
- (1) **.22 Long:** Slightly more powerful than the .25 (especially in long barreled guns). Better expansion properties of the bullet results in greater tissue and nerve trauma. Penetration is poor due to the soft mushrooming of the bullet which tends to disintegrate on heavy bone.
- (2-3) **.22 Long:** When used as a *rifle round* the performance of this cartridge increases dramatically.
- (1) **.25 A.C.P.** (Note: A.C.P. stands for Automatic Colt Pistol). Adequate for self-defense if shots are placed in face, head, neck or body areas with no bones to deflect the small projectile; decent penetration.
- (2) **.32 A.C.P.:** Fair to good protection if used in a high capacity automatic. Decent penetration with little or no expansion, as with all jacketed projectiles used in automatics.
- (2) **.32 Long:** (Revolver) Better velocity and penetration. More variety of loads increases its deadliness.
- (3) **.38 Special:** A good self-defense cartridge with good offensive capabilities.
- (4) **.38+ (Power):** Much more power than the standard .38, with better expansion and penetration.
- (5) **.357 Magnum:** An excellent choice for offense and defense. This cartridge produces great amounts of tissue damage, has excellent stopping power, and has great penetration, even when hollow points are used. An excellent hunting round. The weapon itself has been found to be an easier handgun to master than the 9mm, .45 auto, .41 Magnum and the .44 Magnum.
- (5) **.45 A.C.P.:** Introduced in 1911, this shell has proven itself a man-stopper in many countries and conflicts. This cartridge was created to be used against human adversaries and has little or no hunting value. Wide wound channel is caused by this wide, heavy cartridge, resulting in nerve trauma (shock).
- (5) **.45 Long:** Rates the same as the .45 A.C.P., but has better penetration.
- (5) **.41 Magnum:** High velocity, excellent penetration, a very good man-stopper and fine hunting round. Despite this, the cartridge has never been very popular — .357s and .44 Magnums being in much greater demand.
- (5) **.44 Magnum:** An excellent handgun cartridge. It's large, heavy slug does great amounts of damage to tissue. Great penetration and stopping power. Even if a person were

only wounded, the damage inflicted would probably severely hamper any retaliation (this is also true with a .357 and .41 Magnum, but to a lesser degree). A very good hunting round.

- (1) **5.45mm:** Poor stopping power, with poor to good accuracy.
- (2) **7.62mm Nagant:** A service round used by the Soviet Union and in gas-sealed target revolvers.
- (2) **7.63mm Mauser:** Standard Soviet pistol and sub-machinegun round, under the name of 7.62 Tokarev.
- (2) **7.62mm Parabellum:** Used by Central European police and security forces. Not currently in first line service with any army.
- (3) **7.65mm Long:** Unique to French forces. Comparable in power to the contemporary 9mm Browning long cartridge. (The Browning being the world standard for pocket pistols).
- (2) **9mm Short:** Used by many armies, this cartridge may one day replace the venerable .45 Colt in the U.S. Army due to its better penetration of body armor. Yet, since it does not expand (like in autos), it does not inflict the trauma effect that the fat, stubby .45 round does traveling at slower speeds.
- (3) **9mm Police:** In use with several European police authorities.
- (3) **9mm Makarov:** Not yet made outside the Soviet Union. For use with the Makarov pistol.
- (3) **7.65mm Long:** Unique to French forces. Comparable in power to the contemporary 9mm Browning long cartridge.

## RIFLE CARTRIDGES

- (5) **7.62mm Soviet Model 1943:** Standard infantry cartridge of the Soviet Army. It is in widespread use by third world countries.
  - (5) **5.56mm:** Similar to the 5.45 Soviet. However, this cartridge is longer and narrower and can not be used in the AK-47.
  - (5) **.303 British:** Standard British and Imperial cartridge from 1889 to the 1960's. Best reports indicate that it has never been made in steel-cased form. Excellent range and accuracy.
  - (5) **7.92 Mauser:** Probably the most widely distributed military rifle cartridge in history.
  - (6) **5.45mm Soviet:** For use with the Soviet AK-47.
  - (6) **7.62mm NATO:** Comparable in performance to the 30-06, but in a shorter case. A long-range, sniper-type shell.
- 12 Gauge Shotgun:** Can use a solid slug (6), or can be used with buckshot/scattered shot (5).

## SPECIAL CARTRIDGE TYPES

**Tracer:** This cartridge contains a compound that ignites when the cartridge is fired. This creates a line of light that allows correction of the cartridge's flight path. Cartridge range is reduced by 10-20% compared to a normal cartridge.

**Hollow Point:** The front end of this cartridge is actually the exposed lead core of the round and does not come to a point. Instead, it has a hollow cavity in it. This causes the round to expand on impact, causing a large wound (+4



tissue damage automatic; + 8 tissue damage when used in a revolver). The hollow point is *less* effective against solid/structural objects, ie. doors, brick, etc.

**Dum-Dum:** Handmade, the tip of the shell is cut to expand and shatter on impact. Less penetration than the hollow point or any other shell. Good for short-range. Can not be used in an automatic since it tends to jam. (25% random roll every 50 rounds).

**Full Metal Jacketed:** This cartridge will give a better penetration. This is due to the streamlined design and solid construction. It can be used in pistols and revolvers.

**Armor Piercing/Teflon (KTW Rounds):** This cartridge is not available to the general public, as most people have no reason for using an armor piercing round. It is mostly used by the military and police.

**Exploding Shells:** This shell can only be used in pistols. It can not be used in rifles at any time. This shell is constructed with a small explosive charge encased in the tip, which explodes on contact with the target. However, it is also an unreliable round. There is a 35% chance per shell that it will not explode. The Damage Bonus for this shell is: For low calibre, +6 damage; Medium calibre, +10; and for large calibre, +15 damage.

#### ABBREVIATIONS AND TERMS

**Cartridge:** Type of bullet; ammunition.

**Magazine:** Compartment which holds ammunition and is directly inserted into the weapon.

**Rounds:** The number of cartridges/ bullets fired; ie., 7 rounds = 7 bullets fired, 13 rounds = 13 bullets fired, etc.

**Feed:** Method by which the cartridge enters the weapon.

**Weight:** gm = grams, kg = kilograms.

**Length:** mm = millimeters, m = meters.

**Barrel Length:** This is only the barrel's length; the overall length, when known, is listed in parenthesis after the barrel length.

**Muzzle Velocity:** m/s = meters per second; this indicates the speed at which the cartridge is traveling when it leaves the muzzle of the weapon.

**Approx. Effective Range:** This is the generally accepted, *maximum* range in which this weapon operates most effectively/accurately.

**Bolt-Action:** Used mainly in older rifles. By pulling back the bolt a spent shell is ejected from the breech. A spring-loaded mechanism then snaps the bolt forward, closing the breech, and a fresh shell is moved into firing position.

**Clips:** Metal grips which hold the cartridge by the rim or base, which is then inserted into the magazine, forming part of the magazine mechanism.

**Calibre:** The internal diameter of a weapon's barrel. The American and British usage of calibre is expressed in thousandths of an inch, ie. .357, .45, etc. Others are expressed in millimeters, ie. 9mm, 7.65mm, etc.

**F.N.:** A reference to the weapons manufacturer: Fabrique Nationale d'Armes de Guerre of Belgium.

#### Metric Conversion Chart

This chart can be used to convert the metric measurements used in the weapon stats into feet.

30m = 100ft

40m = 135ft

50m = 165ft

100m = 330ft

200m = 660ft

400m = 1320ft

500m = 1650ft

600m = 1968ft

1000m = 3380ft

1400m = 4620ft

## REVOLVERS AUTOMATIC PISTOLS



#### Browning GP 35

**Country:** Belgium, **Cartridge:** 9mm, **Feed:** 13 round mag., **Weight:** 990gms, **Barrel Length:** 118mm, **Muzzle Velocity:** 350m/s, **Approx. Effective Range:** 135ft (40m), **Damage:** 2D6, **Cost:** \$590.00.



#### 7.65mm 140 Double-Action FN

**Country:** Belgium, **Cartridge:** 9mm short or 7.65mm, **Feed:** (9mm short) 13 round box mag., **Weight:** 640gms, **Barrel Length:** 173mm, **Muzzle Velocity:** (9mm) 280m/s (7.65mm) 295m/s, **Approx. Effective Range:** 165ft (50m), **Damage:** 2D6, **Cost:** \$370.00.



#### Barracuda FN Revolver

**Country:** Belgium, **Cartridge:** .357 Magnum, .38 Special, **Feed:** 6 round cylinder, **Weight:** 1.05kg, **Barrel Length:** 76.2mm, **Muzzle Velocity:** 360m/s, **Approx. Effective Range:** 165ft (50m), **Damage:** 4D6, **Cost:** \$490.00.





### Brigadier

**Country:** Canada, **Cartridge:** .45, **Feed:** 8 round mag., **Weight:** 1925gms, **Barrel Length:** 140mm, **Muzzle Velocity:** 253m/s, **Approx. Effective Range:** 165ft (50m), **Damage:** 4D6, **Cost:** \$450.00.



### 7.65mm Model 61 Skorpion

**Country:** Czechoslovakia, **Cartridge:** .32 A.C.P. (7.65mm), **Feed:** 10 or 20 round box mag., **Weight:** 1.59kg, **Barrel Length:** 112mm (513mm — butt extended; 269mm — butt retracted), **Muzzle Velocity:** 317m/s — 274m/s with silencer, **Approx. Effective Range:** 165ft (50m), **Damage:** 1D8, **Cost:** \$1300.00.



### Erma Olympia

**Country:** Germany, Federal Republic, **Cartridge:** .22, **Feed:** 10 round mag., **Weight:** 1100gms, **Barrel Length:** 200mm, **Muzzle Velocity:** 300m/s, **Approx. Effective Range:** 135ft (40m), **Damage:** 2D6, **Cost:** \$500.00.



### Erma KGP 68

**Country:** Germany, Federal Republic, **Cartridge:** 7.65mm, **Feed:** 9 round box mag., **Weight:** 638gms, **Barrel Length:** 89mm, **Muzzle Velocity:** 280m/s, **Approx. Effective Range:** 135ft (40m), **Damage:** 2D6, **Cost:** \$350.00.



### 7.65mm PP Walther

**Country:** Germany, Federal Republic, **Cartridge:** 7.65mm, 9mm short, **Feed:** 8 round detachable box mag., **Weight:** 682gms, **Barrel Length:** 99mm, **Muzzle Velocity:** 290m/s, **Approx. Effective Range:** 135ft (40m), **Damage:** 2D6, **Cost:** \$600.00.



### .38 Special Mauser Revolver

**Country:** Germany, Federal Republic, **Cartridge:** .38 Special, **Feed:** 6 chamber cylinder, **Weight:** approx. 600-660gms, **Barrel Length:** 63.5mm (175mm), **Muzzle Velocity:** 360m/s, **Approx. Effective Range:** 165ft (50m), **Damage:** 2D6, **Cost:** \$300.00.



### Parabellum Mauser

**Country:** Germany, Federal Republic, **Cartridge:** 7.65mm, **Feed:** 8 round box mag., **Weight:** 910gms, **Barrel Length:** 150mm, **Muzzle Velocity:** 280m/s, **Approx. Effective Range:** 135ft (40m), **Damage:** 1D8, **Cost:** \$620.00.



### 9mm Model P5 Walther

**Country:** Germany, Federal Republic, **Cartridge:** 9mm, **Feed:** 8 round detachable box mag., **Weight:** 795gms, **Barrel Length:** 90mm, **Muzzle Velocity:** 350m/s, **Approx. Effective Range:** 165ft (50m), **Damage:** 2D6, **Cost:** \$925.00.



### 9mm Model 951R Semi P Full Auto Beretta

**Country:** Italy, **Cartridge:** 9mm Parabellum, **Feed:** 10 round detachable box mag., **Weight:** 1350gms, **Barrel Length:** 125mm, **Muzzle Velocity:** 390m/s, **Approx. Effective Range:** 180ft (55m), **Damage:** 2D6, **Cost:** \$450.00.



### .38 Trident Super 4 Renato Gamba Revolver

**Cartridge:** .38 Special, **Feed:** 6 chamber cylinder, **Weight:** 720gms, **Barrel Length:** 101mm, **Muzzle Velocity:** 360m/s, **Approx. Effective Range:** 150ft (45m), **Damage:** 2D6 or 3D6 (power), **Cost:** \$250.00.





**9mm Wz 63 (PM-63) Machine Pistol**

**Country:** Poland, **Cartridge:** 9mm, **Feed:** 25 or 40 round box mag., **Weight:** 1.8kg, **Barrel Length:** 152mm (333mm), **Muzzle Velocity:** 323m/s, **Approx. Effective Range:** 135ft (40m) — Stock extended, **Rate of Fire:** (cyclic) 600 rounds/min., (auto) 75 rounds/min., (single shot) 40 rounds/min., **Damage:** 2D6, **Cost:** \$1200.00.



**.38 Special Model 960 Astra Revolver**

**Country:** Spain, **Cartridge:** .38 Special, **Feed:** 6 chamber cylinder, **Weight:** 1.15kgs, **Barrel Length:** 102mm, **Muzzle Velocity:** 265m/s, **Approx. Effective Range:** 165ft (50m), **Damage:** 2D6 or 3D6 (power), **Cost:** \$250.00.



**Hammerli Model 208**

**Country:** Switzerland, **Cartridge:** .22, **Feed:** 8 round box mag., **Weight:** 750gms, **Barrel Length:** 125mm, **Muzzle Velocity:** 300m/s, **Approx. Effective Range:** 135ft (40m), **Damage:** 1D6, **Cost:** \$1300.00.



**P210-5 P 9mm Model 49 SIG**

**Country:** Switzerland, **Cartridge:** 9mm Parabellum, **Feed:** 8 round box mag., **Weight:** 900gms, **Barrel Length:** 120mm, **Muzzle Velocity:** 335m/s, **Approx. Effective Range:** 165ft (50m), **Damage:** 2D6, **Cost:** \$1500.00.



**P230 Sig Sauer**

**Country:** Switzerland, **Cartridge:** 9mm, **Feed:** 8 round box mag., **Weight:** 720gms, **Barrel Length:** 98mm, **Muzzle Velocity:** 320m/s, **Approx. Effective Range:** 165ft (50m), **Damage:** 2D6, **Cost:** \$575.00.



**7.62mm TT-33 Tokarev**

**Country:** U.S.S.R. **Cartridge:** 7.62mm, **Feed:** 8 round box mag., **Weight:** .85kgs, **Barrel Length:** 116mm, **Muzzle Velocity:** 420m/s, **Approx. Effective Range:** 180ft (55m), **Damage:** 1D8, **Cost:** \$400.00.

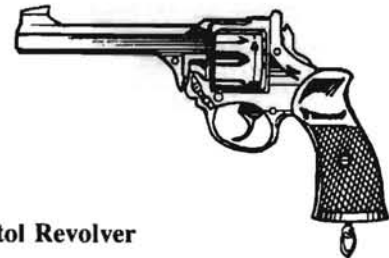

**.38 No. 2 Pistol Revolver**

**Country:** United Kingdom, **Cartridge:** .380 SAA Ball Revolver, .38 Smith & Wesson, .38 Webley, **Feed:** 6 chamber cylinder, **Weight:** 767gms, **Barrel Length:** 102mm, **Muzzle Velocity:** 183m/s, **Approx. Effective Range:** 135ft (40m), **Damage:** 3D6, **Cost:** \$225.00.



**.38 Special**

**Country:** United Kingdom, **Cartridge:** .38 Special, **Feed:** 6 chamber cylinder, **Weight:** 1077gms, **Barrel Lengths:** 70 & 102mm, **Muzzle Velocity:** 360m/s, **Approx. Effective Range:** 165ft (50m), **Damage:** 3D6, **Cost:** \$490.00.



**Auto Mag**

**Country:** U.S., **Cartridge:** .44, **Feed:** 8 round mag., **Weight:** 1665gms, **Barrel Length:** 165mm, **Muzzle Velocity:** 245m/s, **Approx. Effective Range:** 165ft (50m), **Damage:** 4D6, **Cost:** \$650.00.



**Harrington & Richardson Defender Revolver**

**Country:** U.S., **Feed:** 5 chamber side-loading cylinder, **Weight:** 878gms, **Barrel Length:** 101mm, **Muzzle Velocity:** 245m/s, **Approx. Effective Range:** 135ft (40m), **Damage:** 2D6 or 3D6 (power), **Cost:** \$200.00.





**.45 Colt**

**Country:** U.S., **Cartridge:** .45, **Feed:** 6 round detachable box mag., **Weight:** 1190gms, **Barrel Length:** 140mm, **Muzzle Velocity:** 250m/s, **Approx. Effective Range:** 165ft (50m), **Damage:** 4D6, **Cost:** \$400.00.



**.45 Model 15 General Officers**

**Country:** U.S., **Cartridge:** .45 A.C.P., **Feed:** 7 round mag., **Weight:** 1088gms, **Barrel Length:** 171mm, **Muzzle Velocity:** 300m/s, **Approx. Effective Range:** 150ft (45m), **Damage:** 4D6, **Cost:** \$370.00.



**.38 Service-Six Ruger Revolver**

**Country:** U.S., **Cartridge:** .38 Special, **Feed:** 6 chamber side-loading cylinder, **Weight:** 935gms, **Barrel Length:** 101mm, **Muzzle Velocity:** 350m/s, **Approx. Effective Range:** 165ft (50m), **Damage:** 2D6 or 3D6 (power), **Cost:** \$250.00.

**SUB-MACHINEGUNS**



**9mm MD1 and MD 1A1 IMBEL**

**Country:** Belgium, **Cartridge:** 9mm Parabellum, **Feed:** 30 round box mag., **Weight:** 3.28kg, **Barrel Length:** 211mm, **Muzzle Velocity:** 400m/s, **Approx. Effective Range:** 615ft (175m), **Damage:** 2D6, **Cost:** \$1250.00.



**9mm C1**

**Country:** Canada, **Cartridge:** 9mm Parabellum, **Feed:** 30 round box mag., **Weight:** 2.95kg, **Barrel Length:** 198mm, **Muzzle Velocity:** 366m/s, **Approx. Effective Range:** 606ft (185m), **Damage:** 2D6, **Cost:** \$1200.00.



**9mm MP5 Heckler & Koch**

**Country:** Germany, Federal Republic, **Cartridge:** 9mm Parabellum, **Feed:** 15 or 30 round box mag., **Weight:** 2.45kg, **Barrel Length:** 225mm, **Muzzle Velocity:** 400m/s, **Approx. Effective Range:** 660ft (200m), **Damage:** 2D6, **Cost:** \$1450.00.



**9mm Uzi**

**Country:** Israel, **Cartridge:** 9mm, **Feed:** 25 or 30 round box mag., **Weight:** 3.5kg, **Barrel Length:** 260mm (650mm), **Muzzle Velocity:** 400m/s, **Approx. Effective Range:** 660ft (200m), **Damage:** 2D6, **Cost:** \$1050.00.



**9mm Mini Uzi**

**Country:** Israel, **Cartridge:** 9mm Parabellum, **Feed:** 20, 25 or 30 round box mag., **Weight:** 2.70kg, **Barrel Length:** 197mm (600mm), **Muzzle Velocity:** 350m/s, **Approx. Effective Range:** 490ft (150m), **Damage:** 2D6, **Cost:** \$1200.00.

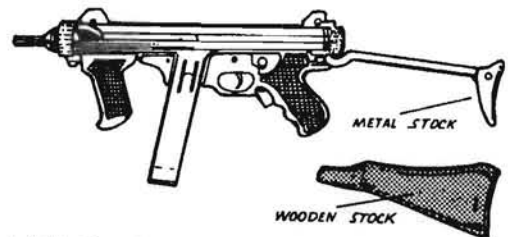

**9mm Model 12 Beretta**

**Country:** Italy, **Cartridge:** 9mm Parabellum, **Feed:** 20, 32 or 40 round box mag., **Weight:** 3kg, **Barrel Length:** 200mm (645mm), **Muzzle Velocity:** 381m/s, **Approx. Effective Range:** 660ft (200m), **Rate of Fire:** Cyclic — 550 rounds/min., auto — 120 rounds/min., single shot — 40 rounds/min., **Damage:** 2D6, **Cost:** \$1200.00.





**.45 Thompson M1**

**Country:** U.S., **Cartridge:** .45 A.C.P., **Feed:** 20 or 30 round vertical box mag., **Weight:** 4.8kg, **Barrel Length:** 267mm (810mm), **Muzzle Velocity:** 282m/s, **Approx. Effective Range:** 660ft (200m), **Damage:** 4D6, **Cost:** \$600.00.

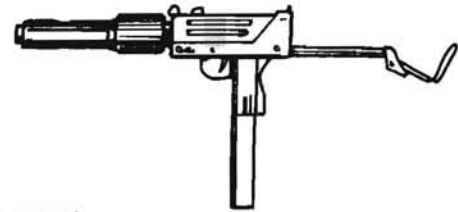

**Ingram Model 10**

**Country:** U.S., **Cartridge:** .45 A.C.P., **Feed:** 30 round box mag., **Weight:** 2.84kg, **Barrel Length:** 146mm (548mm), **Muzzle Velocity:** 280m/s, **Approx. Effective Range:** 660ft (200m), **Damage:** 4D6, **Cost:** \$700.00.

**RIFLES**

**7.62mm Model 30-11 Sniping FN Rifle**

**Country:** Belgium, **Cartridge:** 7.62mm NATO, **Feed:** 9 round removeable box mag., **Weight:** 4.85kg, **Barrel Length:** 502mm (1117mm), **Muzzle Velocity:** 850m/s, **Approx. Effective Range:** 2133ft (650m), **Damage:** 5D6, **Cost:** \$1590.00.

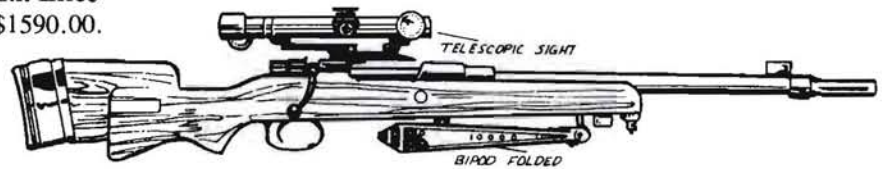

**7.62mm C1A1 Modified Rifle**

**Country:** Belgium, **Cartridge:** 7.62mm, **Feed:** 20 round box mag., **Weight:** 4.25kg, **Barrel Length:** 533mm (1136mm), **Muzzle Velocity:** 840m/s, **Approx. Effective Range:** 2133ft (650m), **Damage:** 5D6, **Cost:** \$750.00.

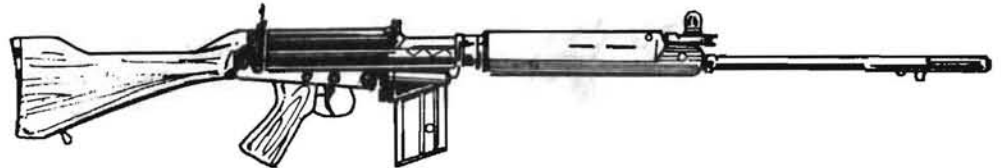

**Model 98 Mauser**

**Country:** Germany, Federal Republic, **Cartridge:** 7.62mm, **Feed:** 5 round internal box mag., **Weight:** 3.89kg, **Barrel Length:** 597mm (1103mm), **Muzzle Velocity:** 754m/s, **Approx. Effective Range:** 1968ft (600m), **Damage:** 4D6, **Cost:** \$600.00.



**WA 2000 Walther Sniping Rifle**

**Country:** Germany, **Cartridge:** .300 Winchester Magnum, 7.62mm NATO, 7.65 Swiss, **Feed:** 6 round box mag., **Weight:** 6.95kg, **Barrel Length:** 650mm (905mm), **Muzzle Velocity:** 780-800m/s, **Approx. Effective Range:** 1968ft (600m), **Damage:** 5D6, **Cost:** \$1550.00.



**7.62mm G3 Heckler & Koch**

**Country:** Germany, Federal Republic, **Cartridge:** 7.62mm, **Feed:** 20 round box mag., **Weight:** 4.4kg, **Barrel Length:** 450mm (1025mm), **Muzzle Velocity:** 780-800m/s, **Approx. Effective Range:** 1320ft (400m), **Rate of Fire:** Cyclic—500-600 rounds/min., auto — 100 rounds/min. **Damage:** 4D6, **Cost:** \$1700.00.

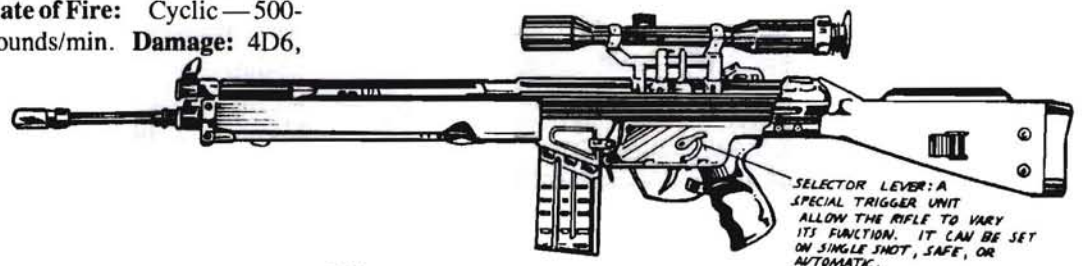

SELECTOR LEVER: A SPECIAL TRIGGER UNIT ALLOW THE RIFLE TO VARY ITS FUNCTION. IT CAN BE SET ON SINGLE SHOT, SAFE, OR AUTOMATIC.



### 7.62mm SAR Galil Assault Rifle

**Country:** Israel, **Cartridge:** 7.62mm NATO, **Feed:** 25 round box mag., **Weight:** 3.75kg, **Barrel Length:** 400mm (915mm), **Muzzle Velocity:** 800m/s, **Approx. Effective Range:** 1800ft (550m), **Damage:** 5D6, **Cost:** \$1450.00.



### 7.62mm Galil Sniping Rifle

**Country:** Israel, **Cartridge:** 7.62mm NATO, **Feed:** 20 round box mag., **Weight:** 6.4kg, **Barrel Length:** 508mm (840mm), **Muzzle Velocity:** 815m/s, **Approx. Effective Range:** 1650ft (500m), **Damage:** 5D6, **Cost:** \$1400.00.

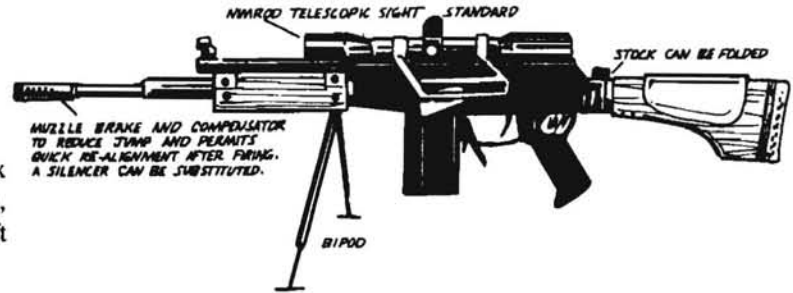

### 7.62mm AK-47

**Country:** U.S.S.R., **Cartridge:** 7.62mm, **Feed:** 30 round box mag., **Weight:** 4.3kg, **Barrel Length:** 414mm (869mm), **Muzzle Velocity:** 710m/s, **Approx. Effective Range:** 985ft (300m), **Damage:** 4D6, **Cost:** \$1420.00.



### 7.62mm Dragunov Sniper (SVD)

**Country:** U.S.S.R., **Cartridge:** 7.62mm, **Feed:** 20 round box mag., **Weight:** 4.3, **Barrel Length:** 547mm (1225mm), **Muzzle Velocity:** 830m/s, **Approx. Effective Range:** 4265ft (1300m), **Damage:** 4D6, **Cost:** \$1570.00.

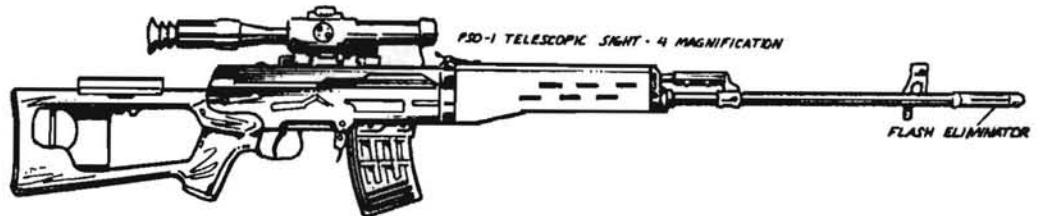

### 5.56mm AR-180 SCS Sterling-Armalite

**Country:** United Kingdom, **Cartridge:** 5.56mm, **Feed:** 20, 30 or 40 round box mag., **Weight:** 3.17kg, **Barrel Length:** 464mm (9406mm), **Muzzle Velocity:** 1000m/s, **Approx. Effective Range:** 1509ft (460m), **Damage:** 4D6, **Cost:** \$700.00.

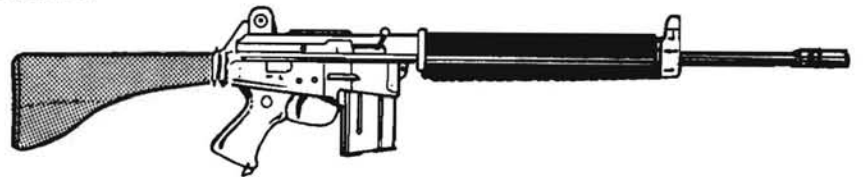

### 5.56mm M16 & M16A1

**Country:** U.S., **Cartridge:** 5.56mm, **Feed:** 20 or 30 round box mag., **Weight:** 3.1kg, **Barrel Length:** 508mm (990mm), **Muzzle Velocity:** 1000m/s, **Approx. Effective Range:** 1320ft (400m), **Damage:** 4D6, **Cost:** \$675.00.





### MG Springfield Armory Survival Gun

**Country:** U.S., **Cartridge:** .22 long rifle rim-fire, **Feed:** single shot, **Weight:** 1.47kg, **Barrel Length:** 457mm (80cm), **Muzzle Velocity:** 300m/s, **Approx. Effective Range:** 1200ft (366m), **Damage:** 2D6, **Cost:** \$700.00.

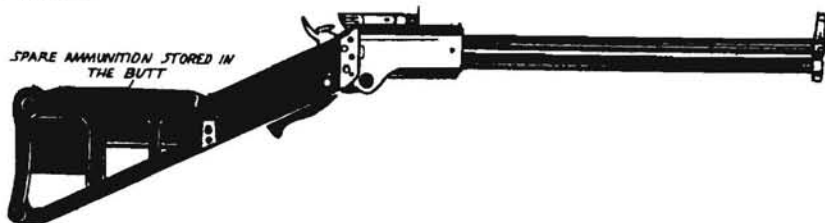

## SHOTGUNS

**Note:** The following stats apply to all shotguns:

**Approx. Effective Range:** 100ft (30m)

**Damage:** 4D6 for Buckshot (scatter)

5D6 for solid slug

### 12 Gauge RS 200 Beretta Shotgun

**Country:** Italy, **Calibre:** 12 gauge, **Type:** manual repeating, pump action, **Feed:** 5-6 round, pump operated, **Weight:** approx. 3kg, **Barrel Length:** 520mm (1030mm), **Cost:** \$450.00.



### Model 12 SPAS Franchi Shotgun

**Country:** Italy, **Cartridge:** 12 bore, **Type:** gas, semi-auto or hand pump, **Feed:** magazine, **Weight:** 3.2kg, **Barrel Length:** 500mm (900mm), **Cost:** \$550.00.

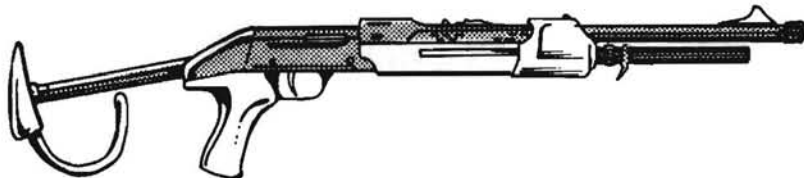

### Model 37M Ithaca Shotgun

**Country:** U.S., **Calibre:** 12 gauge, **Type:** Slide action repeater, **Feed:** 5 or 8 round tubular mag., **Weight:** (20 gauge) 1.58kg, (12 gauge) 2.26kg, **Barrel Length:** 336mm, **Cost:** \$380.00.



### Stakeout Ithaca Shotgun

**Country:** U.S., **Calibre:** 20 or 12 gauge, **Type:** Slide action repeater, **Feed:** 5 round tubular mag., **Weight:** (20 gauge) 1.58kg, (12 gauge) 2.26kg, **Barrel Length:** 336mm, **Cost:** \$380.00.



### Model 3000 Police Smith & Wesson Shotgun

**Country:** U.S., **Calibre:** 12 gauge, **Feed:** Single shot, **Weight:** 3.06kg, **Barrel Length:** 458mm (978mm), **Cost:** \$900.00.





## MACHINEGUNS

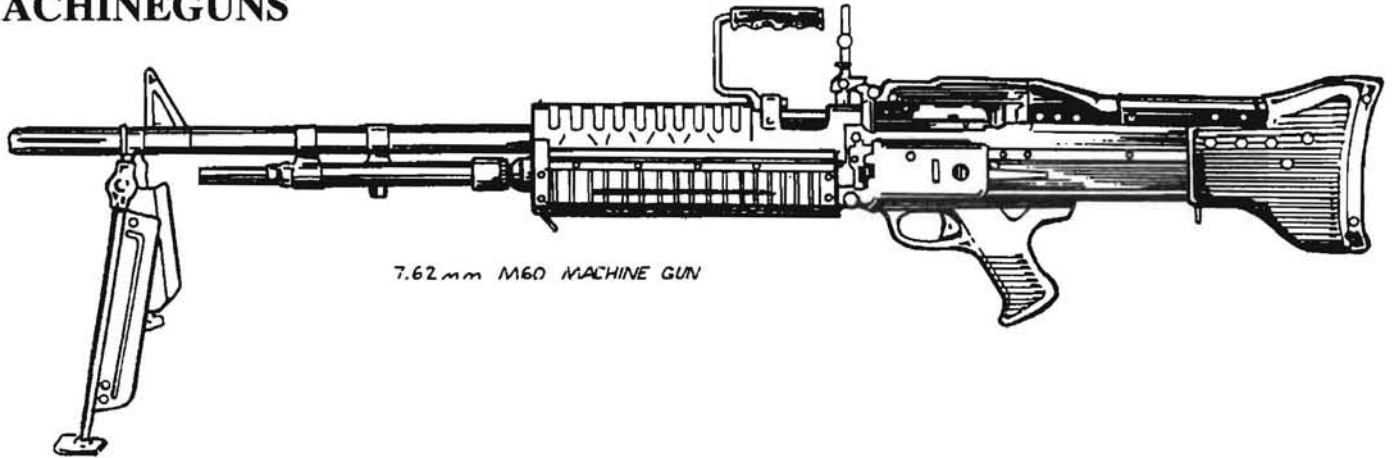

7.62mm M60 MACHINE GUN

### .30, 5.62mm and 7.62mm Calibre Light Machineguns

These are the most common kind of light machineguns found in military forces the world over. **Cartridge:** .30, 5.62mm and 7.62mm in 100, 200 and 250 round belts. **Weight:** 15 to 25lbs. **Effective Range:** 3000ft. **Rate of Fire:** Can empty the weapon in two melee rounds. **Cost:** \$2000.00 and up (mostly illegal). **Damage:** 5D6 per round.

### .50 and 14.5mm Heavy Machineguns

These are commonly found mounted on armored military vehicles. As with their lighter cousins, the heavy machineguns are usually found only in military units. Accuracy is poor because they are meant for use against large vehicles or massed soldiers. On the other hand, they will punch right through armor or engine blocks. **Cartridge:** .50 and 14.5mm belts of varying sizes. **Weight:** 30 to 100lbs. **Effective Range:** 3000ft. **Cost:** \$5000 and up (highly illegal). **Damage:** 7D6 per round.

## HEAVY WEAPONS

### Rocket Launcher

Called the "Super Bazooka", it is designed as an antitank weapon, but was sometimes used against bunkers. **Weight:** 12lbs (5.4kg), front and rear tubes; 9lbs, rocket. **Length:** 61 inches (1549mm). **Effective Range:** 3600ft (1200m). **Damage:** 1D4×100. **Cost:** \$900.00 (mostly illegal). **Blast Radius:** 50ft (15m).

### 66mm Light Antitank Weapon (LAW)

Light and disposable, this is a favorite weapon for taking out "hardened" positions where the enemy has metal or concrete protection. Against tanks it's not quite as effective, actually killing only about 10% of the time. **Weight:** 5.2lbs (2.6kg). **Size:** 35 inches (889mm), extended. **Rate of Fire:** Single shot and discard. **Effective Range:** 1000ft (325m). **Blast Radius:** 50ft (15m). **Damage:** 1D6×100 **Cost:** \$1000.00 (mostly illegal).

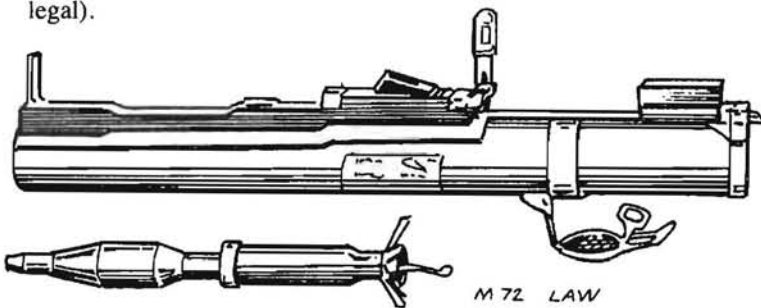

M 72 LAW

### 90mm Recoilless Rifle

This weapon looks like a bazooka or rocket launcher (see antitank weapons). Fires a single, antitank round. **Weight:** 35lbs (16kg), unloaded. **Feed:** Breech. **Rate of Fire:** (rapid) 10 rounds per minute (max. of 5 rounds) – sustained rate of 1 round per minute. When firing at the rapid rate, a 15 minute cooling period must be observed after every 5 rounds. **Effective Range:** 1200ft (400m). **Blast Radius:** 80ft (24m). **Damage:** 1D10×100 **Cost:** \$1600.00 (highly illegal).

### 40mm Grenade Launcher Mounted on Rifle

This was basically a M-79 installed under the barrel on a M-16 Assault Rifle. **Weight:** 11lbs (5kg). **Length:** 15.6 inches (361mm). **Feed:** Single shot. **Rate of Fire:** 3-5 rounds per minute. **Effective Range:** 1150ft (350m). **Damage:** 1D4×100, **Blast Radius:** 20ft (6.1m), **Cost:** \$1000.00 (highly illegal).

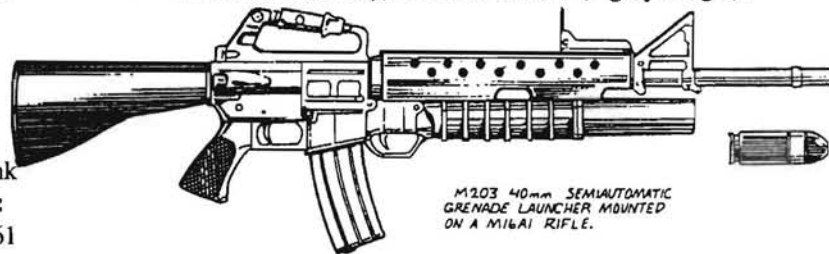

M203 40mm SEMIAUTOMATIC GRENADE LAUNCHER MOUNTED ON A M16 RIFLE.

## SPECIAL GUNS

### Tranquilizer Rifle

This is a rifle designed to fire a tranquilizer dart. Its effective range is about half that of a normal rifle and must be hand loaded, with a maximum capacity of two (both can be fired per melee and require the following melee as a reload time). Saving throw vs. toxin. **Range:** 800ft (240m). **Rate of Fire:** 2 per melee. **Bonus to Strike:** Must have W.P. Rifle. **Damage:** Tranquilizer will render its victim unconscious within 1D4 melees. **Duration:** Effects last 4D4 minutes. **Cost (rifle):** \$1000.00. **Cost (darts):** \$10.00.

### Dart Gun

**Range:** 110ft (33.5m). **Rate of Fire:** 2 per melee. **Bonus to Strike:** Must have a W.P. with Pistol or Revolver. **Damage:** Tranquilizer renders victim unconscious. **Duration:** 4D4 minutes. **Cost (pistol):** \$500.00. **Cost (darts):** \$10.00 each. Savings throw vs. toxin.



### Gas Gun (pistol)

The gas gun is a long, wide, tubular barreled handgun that fires a gas canister. **Types of gases:** Tear Gas, Tranquilizer (knockout), Nerve Gas, and Smoke Gas/Screen. **Cost (gun):** \$200.00. **Cost of Tear Gas and Tranquilizer Gas Canisters:** \$50.00. **Cost of Nerve Gas:** \$75.00. **Cost of Smoke:** \$25.00. **Range:** 160ft (48.8m). **Rate of Fire:** 1 per melee. **Bonus to Strike:** Must have a W.P. with Pistol. **Damage:** Varies with the type of gas used.

### Stun Gun (blaster)

This pistol fires an energy charge that short circuits the nervous system. Victims are dazed, - 10 to strike, parry and dodge, for 2D4 melees.

A successful **saving throw** means that the person has successfully fought off the effect and is unimpaired. Roll to save against each blast that strikes. **Range:** 100ft (30.5m). **Rate of Fire:** 5 per melee. **Bonus to Strike:** Must have a W.P. with Energy Pistol. **Damage:** Special. **Saving Throw:** Save vs toxins. **Energy Capacity:** 10 charges. **Cost (gun):** \$4000.00. **Cost (energy clips):** \$1000.00.

## ENERGY WEAPONS

Energy Weapons are highly experimental, rare and terribly expensive. The high cost is due to several reasons: the compact size, the micronized energy clip, the cost of materials and the lack of mass production facilities. At this point each weapon is carefully hand built. Also don't forget that dozens of highly paid scientist have put years of research into the weapons. Consequently, the current cost of these prototypes is in the hundreds of thousands of dollars. If they were mass-produced, the cost would drop to about 10% of their current expense.

### Standard Laser Pistol

**Range:** 600ft (183m)

**Damage:** 4D6 or 5D6

**Attacks Per Melee:** Up to four blasts, maximum.

**E-Clip Capacity:** 10 blasts

**Weight:** 1.5lbs (.7kg)

**Cost:** \$300,000. An energy clip costs \$25,000.

**Note:** A laser pistol with an energy hip-pack (16lbs (7.3kg)); Range: 300ft (91.5m), and limited E-Clip capacity of 20. Costs \$180,000.

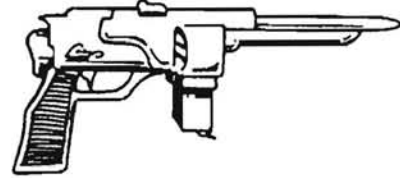

### Standard Laser Rifle

**Range:** 4000ft (1200m)

**Damage:** 6D6

**Attacks Per Melee:** Four

**E-Clip Capacity:** 20 blasts

**Weight:** 7lbs (2.3kg)

**Cost:** \$400,000. An energy clip costs \$25,000.

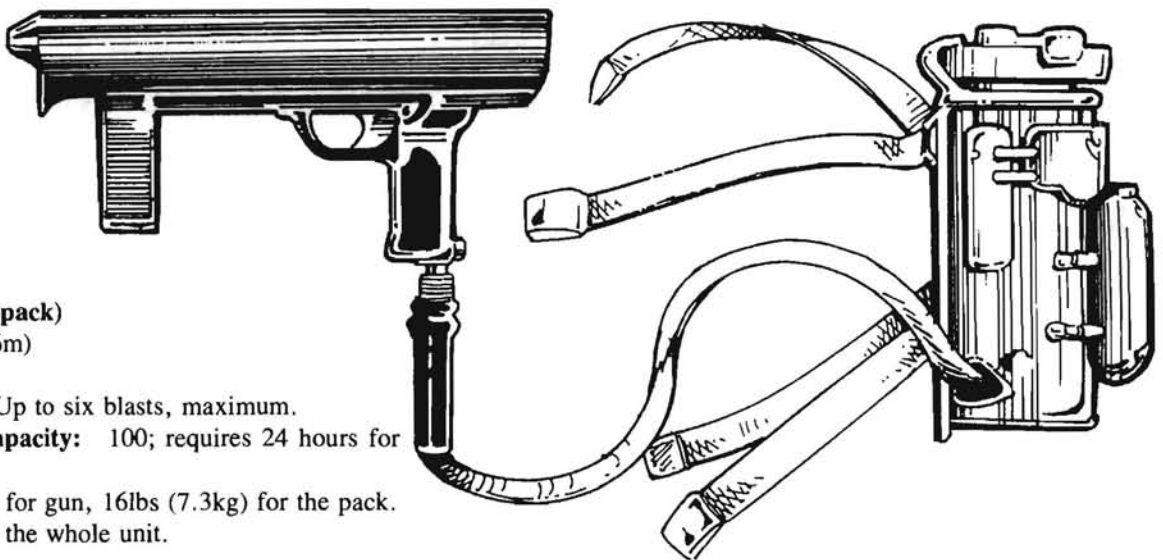

### Heavy Laser (with back-pack)

**Range:** 2000ft (609.6m)

**Damage:** 6D6 + 10

**Attacks Per Melee:** Up to six blasts, maximum.

**Energy Back-Pack Capacity:** 100; requires 24 hours for pack to regenerate.

**Weight:** 6lbs (2.7kg) for gun, 16lbs (7.3kg) for the pack.

**Cost:** \$1,000,000 for the whole unit.



### Mini-Laser (tool)

**Range:** 300ft (90m)

**Damage:** 1D6 or 2D6

**Attacks Per Melee:** Two

**E-Clip Capacity:** 20 charges

**Weight:** 4 ounces (113.4gms)

**Cost:** \$300,000. An energy clip costs \$10,000.

The mini-laser is a utility tool used by mechanics and communications engineers. This handy, all-purpose tool is slightly longer than a normal writing pen (about 8 inches) and twice as wide. It can be easily carried in pockets, clipped onto utility belts, mini-tool packs or even one's boot.

The laser can fire a short laser beam burst of varying intensity or it can unleash a continual beam. **Short Burst:** Damage: 1D6 (1 energy charge), or 2D6 (2 energy charges). **Continual Beam:** Damage: 1D6 (2 energy charges), or 2D6 (3 energy charges per melee).

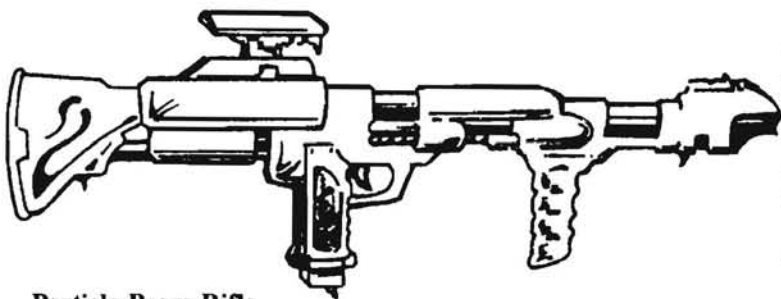

### Particle Beam Rifle

**Range:** 4000ft (1200m)

**Damage:** 1D6 × 10 or 2D8 × 10

**Attacks Per Melee:** Two

**E-Clip Capacity:** 10 blasts

**Weight:** 12lbs (5.4kg)

**Cost:** \$800,000. An energy clip costs \$30,000.

The destructive power of this weapon is awesome. The PBR comes equipped with an infrared, telescopic targeting scope.

#### Damage From A Particle Beam Weapon:

*THE FOLLOWING RESTRICTIONS APPLY TO ALL PARTICLE BEAM WEAPONS:*

When rolling a twenty-sided die to strike an opponent/target, the normal rules are modified. ONLY a roll of 11 through 20 hits; and even then, a roll of 11-17 is only a nick. A roll of 18, 19 or 20 is a direct hit.

**Damage from a nick** (a roll to strike of 11-17) indicates that the particle beam merely grazed its target, which probably means part of it is atomized. A so-called "nick" does 10 to 60 points of damage.



### Simple Blaster (Ion)

**Range:** 400ft (122m)

**Damage:** 2D6 + 2

**Attacks Per Melee:** Up to seven blasts, maximum.

**E-Clip Capacity:** 14 blasts

**Weight:** 2lbs (.9kg)

**Cost:** \$200,000. An energy clip costs \$20,000.



### Heavy Ion Blaster

**Range:** 200ft (61m)

**Damage:** 4D6

**Attacks Per Melee:** Up to four blasts, maximum.

**E-Clip Capacity:** 10 blasts

**Weight:** 2lbs (.9kg)

**Cost:** \$250,000. An energy clip costs \$20,000.

## INCENDIARY WEAPONS

The use of fire has always been popular in U.S. wars. Clearing enemy bunkers with flamethrowers or incendiary grenades is very effective. **Only 1 shot per Combat Round with incendiaries.**

### M-2A1-7 Portable Flamethrower

With a solid stream of fire, a soldier could clear out an entire enemy machinegun nest. In confined spaces (inside a bunker, foxhole or building), everyone in the target area is affected equally. **Damage:** 5D10, plus ignition of all combustible material. **Weight:** 42.5lbs (19kg). **Feed:** Manual. **Effective Range:** 70ft (20m), unthickened; 150ft (45m), thickened. **Cost:** \$400.00 (mostly illegal).

### AN-M14 TH3 Incendiary Hand Grenade

This is one of the most dangerous weapons and not just for the enemy. It is difficult or impossible to throw it far enough to avoid getting hit with fragments. **Damage:** up to 12ft from impact - 1D100 + 20 S.D.C. or 1 M.D.C.; 12-24ft away - 1D100; 24-36ft away - 3D10; 36-120ft away - 1D10. Burns for 10 melee rounds. **Weight:** 24 ounces (.9kg). **Time Delay Fuse:** 4-5 seconds. **Effective Casualty Radius:** Lethal up to 60ft (18m), dangerous to 120ft (36m). **Cost:** \$30.00.

### Molotov Cocktail

**Range Thrown:** 30ft (9m)

**Damage:** Up to a 12ft area — 3D6

Burns for 4 melee rounds.

### Flare Gun

**Range:** 300ft (91.5m)

**Damage:** 2D6 per melee ignited (5 melees)

**Attacks Per Melee:** Two

**Weight:** 2lbs (.9kg)

**Cost:** \$200 for the gun only; flares cost \$10 each. Wide availability.

The flare gun has not changed much over the decades and is basically like those we use today. It is generally used as a signal or to light up an area. *Used for Luminescence:* Lights up a 300ft (90m) area for about five melees (75 seconds). It is not intended to be a weapon, thus it is not balanced for aiming; W.P. handgun skill bonuses do NOT apply.

### Hand-Held Flares

**Range:** Hand Held

**Damage:** One point

**Attacks Per Melee:** Equal to hand to hand attacks.

**Weight:** 6 ounces (170gms)

**Cost:** \$3 each; wide availability.

The hand-held flare is generally used to mark an area or



for signaling. They are similar to those used by present day truck drivers.

#### Rocket Flare

**Range:** 300ft (90m) straight up.

**Damage:** 2D6

**Attacks Per Melee:** One

**Energy Capacity:** One

**Weight:** 5 ounces (141gms)

**Cost:** \$10 each; wide availability.

This hand-held flare has a disposable, one time, launch mechanism which fires the flare gun. Commonly used for expeditions in the wild. A (minus) -3 to strike penalty applies if used as a weapon.

**Rocket Parachute Flare:** A single flare that is fired from a single hand launch tube or flare gun and deploys a parachute-support star. No visible rocket trail is left behind in its launch path to give away the firer's position. Maximum Height: 1000ft (305m), Duration of Illumination: 30 seconds. Power: 200,000 candela. **Cost:** \$10 per flare, plus \$300 for the launcher. Available colors: White, Red, green, and yellow.

**Distress Signal Kit:** Consists of a tube launcher and six red flares. Maximum Height: 900ft (275m), Duration of Illumination: 30 seconds. Power: 10,000 candela, **Cost:** \$120.

**Mini Signal Cartridges:** A lightweight signal cartridge designed for the military special forces. Fired from a single-handed lightweight pen-type launcher. Maximum Height: 320ft (98m), Duration of Illumination: 10 seconds, Power: 150,000 candela. Colors available: Green, red or white. **Cost:** \$250.

## GASES: GRENADES & BOMBS

#### Tear Gas

This extremely potent irritant temporarily impairs vision and respiration, causing eyes to burn and water profusely, skin to burn (a sensation, not in actuality), and making breathing very difficult. **Victims** are -6 to strike, parry, dodge, and lose any chance for initiative. Effects are immediate. **Savings Throw:** None (gas masks counter the gas effectively). **Cost:** \$40.00 each.

#### Knockout Gas

These are tranquilizers; anesthesia-type mists that will induce drowsiness within 1D4 melees and sleep within 1D4 minutes. **Savings Throw:** If a character makes a successful savings throw vs toxins, his body has successfully fought off the effects of the gas and is unimpaired. However, the player must roll once for every minute (four melees) that the character is exposed to the gas (gas masks counter the gas effectively). **Cost:** \$60.00 each.

#### Nerve Gas (paralysis)

This is a gas that attacks the person's nervous system; in this case, causing paralysis. Takes effect within 2D4 melees (two minutes). **Savings Throw:** If a character makes a successful savings throw vs toxins, his body will have luckily fought off the effects of the gas (and should get out quick). Roll a saving throw for each minute (four melees) exposed to the gas. Gas masks are useless against most nerve agents; however, Atropine Injectors, an anti-nerve gas agent, will negate the gas's effects.

**Cost of Injectors:** \$400.00 per dosage. One injector is needed for every ten minutes of exposure and must be administered immediately. **Cost of Gas:** \$120.00 each.

#### Explosive Grenade

**Weight:** 10 ounces (283 grams). **Effective Casualty Radius:** 20ft. **Effective Range:** 100ft (30m). **Damage:** 2D4 × 10, (illegal).

#### Smoke Grenade

**Weight:** 10 ounces (283 grams). **Effective Casualty Radius:** 20ft. **Effective Range:** 100ft. **Damage:** None; creates a smoke filled area to provide protective cover (opponents can not see into or through the smoke) or as a signal. Opponents whose vision is obscured by the smoke are -6 to strike. **Colors:** Black, grey, red, yellow.

#### Rifle Launcher Grenades

Explosive or smoke grenades fired from an assault rifle. The previous stated damage and effects apply. **Rifle Range:** 1150ft (350m). **Single shot, Damage:** 2D4 × 10 to 20ft area.

## EXPLOSIVES

Explosives are generally restricted to industrial and military use and difficult to obtain even for heroes and villains. Unless stolen or provided by a sponsoring organization, characters will be forced to purchase them illegally. Prices on the black market are generally quite steep and circumstance or the individual seller may increase the prices listed by 100%.

#### Black Market Prices

Explosive	Cost	Availability
Dynamite	\$30 per stick	45%
Detonation Caps/Fuses	\$30 each	32%
Plastic Explosive	\$100 per each 2oz	19%
Gelatin Explosive	\$140 per ounce	18%
Liquid Nitroglycerin	\$200 per ounce	20%
Hand Grenades	\$60 each	30%
Smoke Grenades	\$30 each	40%
Rifle Launched Grenades	\$80 each	20%
Mortar Shells	\$100 each	10%

**Note:** There is always a 20% chance that the item is fake or a dud.

**Descriptions** will include two damage ratings. The first is the blast center, where most damage is done. The second is the extended blast radius and damage caused from flying particles of debris.

**Dynamite** is a nitroglycerin based explosive widely used in mining and road construction. It can be detonated with blasting caps, fuses and timing devices. Wick fuses are rarely used today. **Damage:** One stick: 1D4 × 10. **Effective Casualty Radius:** 10ft (3m).

**Liquid Nitroglycerin** is an extremely dangerous, unstable, chemical explosive concentrate. A severe jar, jerk or bump can cause it to detonate; 30% chance. **Damage:** One ounce is equal to four sticks of dynamite: 4D4 × 10. **Effective Casualty Radius:** 20ft (6.1m).

**Plastic and Gelatin** explosives are very localized blast explosives that can be molded and formed like putty. Inert — you



can slam a plastic explosive into a wall and nothing will happen. It can only be activated/ignited by an electrical blasting cap that will pass an electrical charge through it, causing it to explode. Any electrical charge, blast or bolt is also likely to detonate it; 55% chance. **Damage:** 2 ounces is equal to one stick of dynamite: 1D4 × 10. Area effect of blast is exactly where the plastics or gel has been placed; about one foot. Of course, depending on what is being exploded, it could cause much more additional destruction and damage. These are the types of explosives used to open safes and for sabotage. They are not effective area effect weapons.

**Homemade Bombs** usually incorporate chemicals or dynamite.

## MISCELLANEOUS MODERN WEAPONS

**Black Jack:** A small hand held club, usually handmade, 10 inches long, weighing 2 to 4 pounds. **Cost:** \$20. **Damage:** 1D6.

**Brass Knuckles:** **Cost:** \$20. **Damage:** 1D6.

**Cattle Prod:** An electric rod, operated on "C" cell batteries, that emits a 4500 volt shock when it is touched to the skin. 12 or 22 inch lengths. **Cost:** \$20. **Damage:** 1D4.

**Itching Powder:** Range varies with applications; can be used as a powder, launched in a grenade, housed in a pellet that ruptures on impact, and similar devices. Victims are very uncomfortable, distracted and are -3 on initiative. **Duration:** 1D4 hours or until washed off. Affects only bare skin. **Costs:** Only a couple of bucks per ounce from a novelty shop.

**Hair Spray:** Can be used to temporarily blind an opponent. Victims are -6 to strike, parry and dodge. **Effective Range:** 3ft (.9m). **Duration:** 1D4 melees. **Cost:** \$3.

**Mace:** A stinging chemical spray that blinds one's opponent (much better than hair spray). Victims are -6 to strike, parry and dodge. **Effective Range:** 4 to 6ft (1.2 to 1.8m). **Duration:** 4D4 melees. **Cost:** \$16.00, with about 20 sprays before empty.

**Modern Crossbow** with rifle stock, 150lb draw weight. **Range:** 500ft (150m). **Damage:** 2D6. **Cost:** \$180.

**Slap Glove:** Six ounces of powdered lead is built into each glove just above the knuckles, padding the wearer and adding weight and strength to the force of one blow. +2 to damage. Available from most security guard suppliers. **Cost:** \$30.

**Fiberglass Nightstick:** **Cost:** \$10. **Damage:** 1D4.

**Steel Rod Encased Nightstick:** **Cost:** \$20. **Damage:** 1D6.

**S.W.A.T. Entry Tool** a.k.a. Hooligan Tool: A long, one inch thick, stress proof bar, heat treated for durability and strength. On one end is a large chisel, spike-like, pry bar. On the opposite end is a claw/chisel point (crowbar-like). Used to pry open security doors and grilles. **Cost:** \$240. **Damage:** 1D8 (either end). Pops normal door locks on a roll to strike of 8-20; pops heavy locks and security door locks on a roll to strike of 12-20.

**Modern Knives:**

**Combat Bush Knife:** Heavy-duty, all-purpose survival knife. The best carbon steel 7in blade. **Cost:** \$200. **Damage:** 1D6.

**Slimpack Throwing Knife:** With a flat, lambskin sheath, this knife is perfect for concealment. Also a perfectly balanced 6in blade. **Cost:** \$50. **Damage:** 1D6.

**Belt Throwing Knife Set:** 4 ultrathin throwing knives in a single belt sheath designed for an easy, fast draw. **Cost:** \$135. **Damage:** 1D6.

**Polycarbonate Knife:** This 7in knife (with silk sheath) is guaranteed not to show up on metal detectors. Balanced for throwing, yet with a keen edge for slicing. **Cost:** \$300. **Damage:** 1D6.

**Small Boot Knife:** For easy concealment. **Cost:** \$20. **Damage:** 1D4.

**Bayonet:** Attaches to combat rifles. **Cost:** \$140. **Damage:** 1D6.

## SLR-60/Spike Launch Rod

**Range:** 200ft (60m)

**Damage:** 2D6

**Attacks Per Melee:** One

**Energy Capacity:** 30 charges

**Weight:** 2lbs (.9kg)

**Cost:** \$1,200

This small, (2ft (.6m)) rod-like device is used for climbing. The SLR-60 can effectively fire a small (6 inch) metal spike up to 60 meters away carrying a high test line along with it for scaling surfaces. It comes equipped with 130 meters of heavy-duty cord, detachable spool, and feeder with digital counter. Additional spikes are available at \$30 a dozen, while additional clip-in, prewound spools of 400ft (130m) line costs \$200 each.

## Grappling Hook & Line

**Range:** 100ft (30.5m)

**Damage:** 1D4

**Attacks Per Melee:** Equal to hand to hand attacks.

**Weight:** 2lbs (.9kg)

**Cost:** \$150 for hook and 300ft of line.

This is your typical grappling hook and line for scaling surfaces.

## FIREARM ACCESSORIES

**Ankle Holster:** Padded for comfort, with velcro closure. Fits a snub-nosed revolver or any *small* frame automatic. Can be concealed under pant leg. \$34.00

**Inside Trouser Holster:** Clips on belt or waistband of pants. \$20.00.

**Side Holster (fits onto belt).** \$50.00.

**Belt Slide Holster.** \$50.00.

**Belt Thumbbreak Holster.** \$50.00.

**Patrolman, Police-Style Belt and Holster,** 24 bullet loops. \$80.00.

**Police-style Shoulder Holster.** \$80.00.

**Military-style Shoulder Holster.** \$70.00.

**Horizontal Shoulder Holster.** \$85.00.

**Scoped Shoulder Holster.** \$90.00.

**Concealed Wallet Holster** for *small* automatic weapons; fits easily into back trouser pocket. \$40.00.

**Web Belt** with holster, ammo pouch (2) and accessory attachment clips (4). \$60.00.



**Magazine Clip Pouch:** Each of these specially designed ammo pouches is designed for 2 (slimline) or 4 (heavy-duty) ammo clips. Choice of camouflage, green, khaki or black colors.  
 Automatic Pistol: 2 clips, \$10; 4 clips, \$16.  
 Sub-Machinegun: 2 cell — \$12; 4 cell — \$18.  
 5.56mm Assault Rifle, 20-rnd: 2 clips, \$14; 4 clips, \$20.  
 5.56mm Assault Rifle, 30-rnd: 2 clips, \$18; 4 clips, \$24.  
 7.62mm Assault Rifle, 20-rnd: 2 clips, \$18; 4 clips, \$22.  
 7.62mm Assault Rifle, 30-rnd: 2 clips, \$20; 4 clips, \$26.

**Magazine Ammo Bags. \$30.00.**

**Assault Rifle Case. \$70.00.**

**Rifle Case. \$60.00.**

**Sub-Machinegun Case. \$60.00.**

**Shotgun Bandoleer:** Bandoleers are made of brown leather, with a heavy-duty, brass belt buckle. Shotgun version will hold 56 rounds. 40mm grenade version holds 18 rounds. \$24.

**Wrist Cartridge Bandoleer:** Perfect for concealing 3 extra cartridges. \$15 each.

**Metal Ammunition Boxes:** These waterproof ammo boxes are designed for easy storage and carrying. .50 caliber size: \$10. .30 caliber size: \$8.

**Field Gun Cleaning Kit:** A complete cleaning kit contained in its own pouch. \$35.00.

**Gun Repair Kit:** This is a 4lb gun repair kit. Each tool is fitted into a separate loop and there's plenty of room for spare bolts, screws, springs and cleaning rods. Contained in a 12 inch by 8 inch by 2 inch case. Can be attached to a harness or worn over the shoulder with strap, which is included. \$250.

**Magazine Clips:** Any weapon, any size, from 7-round pistol to 30-round rifle. \$.89 each.

**Web Belt:** Classic military belt complete with buckle and pouch fasteners. Choice of camouflage, green or khaki. \$20.

**Battle Harness:** Combination of suspenders and belt designed for distributing the weight of ammo pouches and accessories. In choice of camouflage, black, grey, brown, cream or khaki. \$120.00.

**Battle Pack:** Lightweight frame, heavy-duty, water resistant canvas. Multiple interior and exterior compartments. Fasteners for exterior pouches/grenades. Choice of camouflage, green or khaki colors. \$350.00.

**Multi-Purpose Pouch:** All around, useful utility pouch designed for attachment to web belt or battle harness. \$8.00.

**Silencer:** A silencer is a barrel-like attachment which fits over the barrel of a gun to muffle the sound of the report. Reduces range by 10%.

**Cost by Type:** Revolver — \$350  
 Automatic Pistol — \$500  
 Bolt Action Rifle — \$600  
 Automatic Rifle — \$1500  
 Sub-Machinegun — \$2000

**Note:** Not available on the commercial market.

**Flash Suppressor:** Another barrel shaped attachment that can fit over the barrel of a gun or silencer. This instrument masks the guns flash. Usually used for covert night operations. Reduced range by 15%. If both a silencer and flash suppressor are used, range is reduced by 25%.

**Cost by Type:** Revolver — \$250  
 Automatic Pistol — \$450  
 Bolt Action Rifle — \$1200  
 Sub-Machinegun — \$1600

**Note:** Not available in the commercial market.

## AMMUNITION (Prices Per Box of 100)

.22 caliber	\$12.00
.32 caliber	\$14.00
.38 caliber	\$18.00
.45 A.C.P.	\$28.00
.41 Magnum	\$30.00
.44 Magnum	\$32.00
.357 Magnum	\$28.00
9mm & 7.65mm	\$30.00
5.56mm (rifle)	\$40.00
7.62mm (rifle)	\$48.00
Tracer Cartridge	\$45.00
Hollow Point	add \$12.00
Full Metal Jacketed	add \$25.00
*Teflon (armor piercing, not available to the public)	add \$100.00
*Exploding Shell (not available to the public)	add \$200.00
*Dum Dum (handmade, black market, any caliber)	add \$10.00 to \$30.00.

\*40mm Grenade Cartridge \$700.00 (per 100)

\*Ammo with an asterisk are *NOT* available at the neighborhood gun shop, but can be tracked down by the black market and illegal arms dealers. The added price provided is a minimum and can cost two or three times more.

## BODY ARMOR

Cost	Ancient Styles	A.R.	S.D.C.	WT.
\$175.00	Padded or Quilt	8	15	66lbs
\$300.00	Soft Leather	9	20	8lbs
\$600.00	Studded leather	12	38	20lbs
\$900.00	Chain Mail	13	44	40lbs
\$1500.00	Scale Mail	15	75	45lbs
\$2000.00	Plate and Mail	15	100	52lbs
\$2800.00	Plate	16	150	58lbs
\$3000.00	Plastic Plated	13	80	28lbs

**Note:** The costs reflect the rarity of manufacturers/builders and the time involved in the construction. Homemade armor is possible, reduce cost by half. A.R. 2 and S.D.C. by 20%.

Cost	Modern Styles Light (half suits)	A.R.	S.D.C.	WT.
\$1200.00	Concealed	10	50	12lbs
\$900.00	Riot Jacket	10	60	12lbs
\$800.00	Vest	10	50	10lbs
\$1100.00	Point Blank Vest	10	70	14lbs
\$1400.00	Hard Armor Vest	12	120	15lbs

Cost	Heavy Armor (full suit)	A.R.	S.D.C.	WT.
\$1400.00	Frag. Cape/Vest	13	120	16lbs
\$1600.00	Riot Armor	14	180	17lbs
\$2200.00	Hard Armor	16	260	20lbs
\$2800.00	Class 4 Armor	17	280	20lbs

**Note:** Half Suits or vest types usually protect the upper body



front, back, side, waist and groin. Concealed are tough thin styles designed to be sown into clothes or hidden under clothes (shirts, jackets, etc.). The others are all generally bulky or worn atop clothes.

**Full suits** are all bulky suits worn on top of clothes and provide the greatest protection.

**All modern armor** is designed for flexibility and mobility and does not interfere with movement, prowl or speed. Many types of armor are constructed of glass-reinforced plastic, chemically strengthened with woven glass fibers and is thicker than metal yet lighter. Other common types use steel or lightweight alloys typically ¼ inch thick. These two types of armor can stop all pistol, revolver, sub-machinegun and low calibre rifle shells.

**Hard armor** is composed of ceramics, a form of opaque glass made from pure alumina or boron carbide. They are often combined with steel. Hard armor types provide the most effective protection and can even stop 7.62mm NATO and 5.56mm rifle bullets.

## OPTICS

### GOGGLES AND BINOCULARS

**Binoculars and Telescopic sights** magnify an image area through a system of lenses.

Binocular and Telescopic Sights	Cost
Binocular (2000ft), best magnification	\$1600.00
Binocular (1600ft), medium magnification	\$1000.00
Binocular (1600ft), low magnification	\$600.00
Weapon Sight, best magnification	\$800.00
Weapon Sight, medium magnification	\$400.00
Weapon Sight, low magnification	\$230.00

**Infrared Optic System:** **Range:** 1200ft (360m). This type of optical enhancement device relies on a source of infrared light, usually a pencil-thin beam of light projected from the goggle or binoculars, to illuminate its targets. The narrowness of the beam severely limits the scope of one's view to a small area of about two square meters (7ft). This can make surveying a large area a problem. Another drawback is that the infrared light beam is clearly visible to another infrared optic system, giving away the operator's position. These drawbacks are inherent to ALL infrared systems. **Cost:** about \$1000; fair availability.

Infrared (range: 1200ft)	Cost
Goggles (mercury battery type)	\$550.00
Goggles (new superior type)	\$880.00
Binoculars	\$2100.00
Monocular Eyepiece	\$800.00
Weapon Sight	\$1200.00

**Infrared Distancing Binoculars:** A high-powered optical enhancement device with infrared adjustments, cross hair indicator lines, and digital readout of estimated distance and rate of travel. **Range:** 2 miles (3km). The I.D. binoculars enjoy extreme popularity among spies, being used for field work and exploration, and are also used by the military. **Cost:** \$6700. Not commercially available.

**Ultraviolet Systems:** **Range:** 400ft (120m). Enables its wearer to see into the ultraviolet range of light radiation. It's usually integrated into a larger optics package rather than used alone. **Cost:** \$500.

**Night Sight:** **Range:** 1600ft (480m). A night vision optics system is an image intensifier; meaning that it is a passive system that does not emit any light of its own, but electronically amplifies existing, ambient light to provide a visible picture. **Cost:** \$1400; poor availability.

Night Sights (range: 1600ft)	Cost
Goggles	\$5200.00
Binoculars	\$6400.00
Monocular Eyepiece	\$1900.00
Weapon Sight	\$1800.00
Pocket Night Viewer (800ft range)	\$1500.00
Large Tripod Mount	\$14000.00

**Pocket Night Viewer:** **Range:** 800ft (240m). This is a mini-night sight, usually a monocular style, easily concealed and portable. **Cost:** \$800; poor availability.

**Thermo-Imager:** **Range:** 1600ft (480m). Basically an optical heat sensor, it converts the infrared radiation of warm objects into a visible image. This device allow its operator to see in darkness, shadows and through smoke. Battery powered and electrically cooled. A typical running life is 16 hours. **Cost:** about \$1400; poor availability.

Thermo-Imager (range: 1600ft)	Cost
Goggles	\$22,000
Binoculars	\$20,000
Monocular Eyepiece	\$18,000
Weapon Sight	\$18,000

### MULTI-OPTICS HELMET

SIDE VIEW



FRONT VIEW



**Multi-Optics Helmet (M.O.H.):** The multi-optics helmet is a special optical enhancement system built into a protective helmet. It includes the following features:

1. **Targeting Sight:** 1600ft (480m)
2. **Infrared Optics System:** 1600ft (480m)
3. **Telescopic Monocular Lens:** Range: 2 miles (3km)
4. **Thermo-Imager:** Range: 1600ft (480m)

**Special Bonus:** +1 to strike when the optics and targeting sight are engaged. Note that the thermo-imager is a special, optical, heat sensory unit that allows the infrared radiation of warm objects to be converted into a visible image. Enables the person to see in darkness, shadows and through smoke. **Cost:** \$38,000. Available to high-tech organizations.

**Optics Band:** The optics band is a headband type optical system most often used in research, micro-repairs and scientific study. Its range is limited as it is designed for close work, not long-distance or combat surveillance. Features include:



1. **Infrared and Ultraviolet Optic System:** **Range:** 200ft (90m) maximum.
2. **Magnification Lens** (to the 400th power): **Range:** 7ft (2m)
3. **Night Sight:** **Range:** 200ft (90m)
4. **Adjustable Color Filters.**  
**Cost:** \$2800.00.

**Pocket Range Finder:** An optical range finder that is compact and easy to use. Just look through the viewfinder and adjust the focus knob until the image is clear. The range in feet AND meters will appear below the target. **Cost:** \$58.

**Illuminating Peglight:** Designed for military use as markers for routes and minefields. Emits beta light which emits no heat and gives no infrared emissions. Can be seen from distances of up to 150ft. **Cost:** \$50 each.

## COMMUNICATIONS

**Communications Equipment:** Communications equipment is fairly basic in regards to the character's use and needs. Various surveillance and video systems might be added on, depending on the circumstances and the player's ingenuity.

**Field Radio:** A back-pack style, radio transmitter and receiver with wide band, long-range capabilities; frequency equalizer, field strength detector and scrambler. **Range:** 60 miles (96km). **Weight:** 16lbs (7kg). **Cost:** \$1400.00; good availability.

**Back-Pack Radio:** A Japanese updated version of the old PRC-25. Comes with built-in scrambler and up to 1500 channels. Also capable of receiving commercial AM/FM/Television (sound only) and Short-Wave signals. RKO-68. **Range:** 35 miles (56km). **Cost:** \$925.

**Belt Radio:** A lightweight unit designed to work with the RKO-68. Scrambler equipped, 2 to 3 mile range, up to 10 preset channels. Weighs only 2lbs, complete with pouch and telephone-style handset. RKO-12. **Cost:** \$115.

**Headset Receiver:** These receiver-only units are easily attached to the helmet. Built-in scrambler and range of 2 miles. **Cost:** \$42.

**Hand-Held Communicator:** Basically an enhanced walkie-talkie, it is a basic instrument issued to all military personnel and field operatives. **Cost:** Per single unit — \$3200. This is a high-tech item available only to the special branches of the military (espionage) and major scientific organizations/industries. **Weight:** 6 ounces (170grams). **Range:** 3 miles (4.8km).

**Ear Mike Radio Receiver and Transmitter:** A tough, reliable radio device that plugs into the ear. With the help of a transducer connected to a receiver/transmitter device, and manually activated for speak or listening modes, the user can both listen and speak through the earphones. This is possible because the ear canal captures ingoing and outgoing sound (your voice), as well as incoming sounds. It is so effective that the user can transmit a whisper.

Compatible with any portable, two-way radio equipped with an external speaker/microphone. **Weight:** 6 ounces (170 grams). Power source is one AA 1.5 volt battery. **Range:** 1 mile. **Cost:** \$500.

## SURVEILLANCE EQUIPMENT

**Keyhole or Tube Microphones:** A microphone (mic.) with a long, hollow tube which can be flexible or stiff, allowing it to be placed in cracks, mounted in walls, or placed in similar, small, "keyhole"-type crevices. Picks up sounds up to 34ft (10m) away and transmits up to 1000ft (300m). **Cost:** \$170; fair availability.

**Contact Microphone:** Translates vibrations into sound, but requires a sounding board, such as a wall, windows, large object, etc. Can be as small as a tie tack. Picks up sounds up to 10 meters away and transmits up to 1000ft (300m) away. **Cost:** \$170, fair availability.

**Commercial Wireless Microphone:** (entertainment). **Cost:** \$50-100.

**Compact Commercial Wireless Microphone:** (size of a pack of cigarettes). **Cost:** \$70-\$150.

**Wireless Microphone:** This compact mic. is about the size and thickness of a box of matches. It can pick up sounds up to 14ft away and broadcast up to 300ft away. **Cost:** \$500; poor availability.

**Tracer Bug:** This is a tiny device, about the size of a checker, which has a sticky or magnetic side that can be attached to a vehicle or slipped into a person's pocket, back pack, briefcase, etc. It can transmit a signal that can be followed up to 8 miles (12km) away. Battery powered, it has a limited life of 72 hours of constant transmission. **Cost:** \$140; fair availability.

**Bumper Beeper:** Attaches to automobile bumper via magnetized clip. The antenna can be permanently mounted or detachable. Transmits a signal that can be followed up to five miles away (battery powered). The receiver picks up and can locate the beeper by the intensity/strength of the signal. **Cost:** (includes receiver) \$1100.00.

**Listening (bugging) Device:** Average range: 600ft.

**Tie Clasp:** Microphone; **Cost:** \$15.00.

**Electret Condenser Lavalier Mic.:** Can be hung around neck or attached to cloth. Battery operated or plugged in. **Cost:** \$50.

**Broadcast Quality Tie Tack:** **Cost:** \$160.00.

**Special Bugs:** These come in a variety of sizes, from postage stamp to martini-olive type, complete with mic., transmitter and amplifier. **Average Range:** 60ft. **Cost:** \$400.

**Room Bug:** This bug taps into the wall current (needs capacitor). **Range:** 1200ft. **Cost:** \$100 (homemade) or police version — \$500.

**Transmitters** (typical) — \$200.

**Transmitters** (quality crystal) — \$500.

**Low-Frequency Converter:** \$500.

**Frequency Equalizer** (controls cutoff of certain frequencies and boosts others). **Cost:** \$190.

**Test Transmitter:** **Cost:** \$65.

**Additional Transducer:** **Cost:** \$75.

**Telephone Induction Unit:** **Cost:** \$65.

**Sound Amplifier:** **Cost:** \$50.

**Sound Amplifier (high quality):** **Cost:** \$250.

**Telephone Bugs**

**Drop in Cartridge:** Battery powered; fits in the telephone receiver. **Cost:** \$320.



**Room Bug Mini-Transmitter:** Looks like a telephone jack; battery operated. **Cost:** \$240.

**Telephone Line Transmitter:** Taps right into telephone line and power (needs no batteries, will run indefinitely). A little larger box than the mini-transmitter. **Cost:** \$250.

### Bug Detectors

**Field Strength Meter:** Picks up radio signals and registers them. **Cost:** \$350.

**Broadband Receiver:** Causes a feedback and makes a howl when near a transmitter. **Cost:** \$425.

**Pocket Vibration Detector:** **Cost:** \$600.

**Pocket Scrambler:** The scrambler will distort or "scramble" outgoing radio signals, preventing interception and interpretation by the enemy. **Cost:** \$1300; poor availability.

**Portable Telephone Scrambler:** Converts normal speech into unintelligible gibberish over the telephone line and converts the gibberish into clear speech. 25 different scrambling codes. Fully transistorized and can be used on any conventional phone. **Cost:** \$1400. Comes with an impact resistant carrying case.

## OTHER SURVEILLANCE DEVICES

**Video Briefcase:** An ordinary looking briefcase with a video recording surveillance system built into it. The tiny pinhole lens is nearly invisible (18% chance of it being noticed). Three hour film capacity. Reinforced, impact cushioned case with a back-up, mini-cassette tape recorder. **Cost:** \$3400.

**Video Wall Mount:** This small, remote video camera is only about the size of a man's palm (5 inches in diameter), thus it is easily concealed. The camera is backed with a powerful suction device that will adhere to any smooth surface, whether it be a wall, table, appliance, vehicle and so on. The video wall mount can broadcast continually for 72 hours, or by remote or preprogrammed, regulated intervals. The lens has limited mobility, able to rotate in about a 90 degree radius. Its audio capacity has twice the duration of its video transmission and is able to pick up sounds up to twenty feet (6m) away with crystal clarity. The monitor can be the mini-hand-held screen or any variety of larger or multi-unit monitors. **Cost:** \$3200. Not available through the conventional market, but a hot commodity on the black market. Hand-held monitor costs \$450.

**Mini-Telephoto Document Camera:** A tiny, easy to conceal camera, only a little bigger than a disposable lighter. **Cost:** \$350.

**Note:** Conventional video systems, cameras, lenses, optics and audio recorders, are also effective tools for surveillance.

## SENSORY EQUIPMENT

**Dosimeter:** Picks up and measures radiation levels. **Range:** 20ft (6.1m). Hand-held; **Weight:** 11lb (.5kg). **Cost:** \$200. Wide availability.

**Ground Sensor System:** Uses seismic and laser sensors to detect vehicles/men, their direction and their numbers. A good communications engineer can make such projections with 75% accuracy. The control unit, with digital display, computer mount and monitor, is the center of this sensor web or fence. Up to 22 transmitter/receiver, sensor units can be linked to the control unit. Range between transmitters is 800ft

(240m) and can register activity up to 10 miles (16km) away. **Cost:** \$48,500. Poor availability; generally limited to the military and scientific research.

**Heat:** Special sensors pick-up and measure heat emanations. Can monitor temperature, or made directional to pinpoint a specific heat point/target. **Range:** 250ft (76m); field of detection is 25ft (7.6m). Portable/hand held. **Weight:** 8lbs (3.6kg). **Cost:** \$1200.

**Microwave Fence:** Transmitter and receiver sensor posts emit an invisible, microwave curtain or fence that will light up and send a signal to the control unit when an intruder breaches its curtain. Range between transmitter posts is 500ft (150m). Posts are 7ft (2m) high. Can effectively cover a 14 mile (22km) area. **Cost:** \$60,000. Poor availability; primarily used for military purposes.

**Motion:** Detects movement and pinpoints location. Requires sensor placement and monitor screen. **Range:** 60ft (27.4m). Portable; **Total Weight:** 15lbs (6.8kg). **Cost:** \$400. Fair availability.

**Motion Detector Signaler:** This device is virtually identical in purpose and use as the ultraviolet signaler, except that it does not emit any vibrations in the air. **Cost:** \$1000; poor availability.

**Mini-Radar/Sonar:** Requires radar signal unit and monitor. Trained operators (sensory equipment skill) can positively identify readings/objects, pinpoint location and estimate rate of travel and direction at 65% proficiency. **Range:** 5 miles (8km). Portable; **Total Weight:** 18lbs (8.2kg). **Cost:** \$22,500. Fair availability.

**Standard Radar/Sonar Unit (large):** **Range:** 100 miles (160km). **Weight:** 260lbs (117kg). **Cost:** \$26,000.

**Ultraviolet Signaler:** The signaler is a small strip of ultraviolet sensors and another transmitter strip that can be adhered to a doorway, walls and so on, to create a beam of invisible light, blocking that area. When the beam is broken by an intruder or vehicle, etc., it will send a silent signal to a monitoring device and/or trigger a video unit. **Cost:** \$900; fair availability.

## SPECIAL EQUIPMENT

**Portable Laboratory:** This is another impressive portable unit that can perform several functions.

1. **Microscope** in a specially padded housing.
2. **One dozen specimen slides** and another dozen specimen trays for storage and transportation of item(s) for further analysis. A variety of vials, jars and test tubes.
3. **An incubation chamber** that is about the size of a VCR (1½ft × 1ft × 8in. deep).
4. **Four burners.**
5. **Instrument tray** with a variety of common tools, such as scalpels, tweezers, pins, tape, needles, calculator, etc.
6. **A refrigeration chamber** which is about half the size of the incubation chamber.
7. **An isolation chamber.** A special, airtight, sealable compartment about the size of the incubation chamber.
8. **A chemical cabinet** which holds several dozen chemicals commonly needed in the analysis of chemical structures.
9. **Centrifuge Device.**
10. **Dosimeter.**



11. **Tape recorder.**
12. **Mini-computer.**
13. **Mini-still camera, 35mm, 32 photo capacity.**
14. **Toxic analyzer** identical to the one used in the "portable bio-scan".

**Cost:** \$42,000; poor availability. **Weight** of the whole unit is 58lbs (26kg).

**Portable Scan Dihilator:** The portable scan dihilator is an uniquely comprehensive sensory device with FULL scanning capabilities.

1. **Radar/Sonar: Range:** Limited to a 5 mile area. A trained operator (sensory equipment skill) can positively identify readings as specific objects or vehicles, pinpoint location, and estimate rate of travel and direction at 65% proficiency.
2. **Sensors** include dosimeter, radar detector, heat, infrared, ultraviolet, microwave, and energy sensitive instruments; all of which identify, locate source, and record.
3. **Long-range, wide band radio** with scrambler. **Range:** 40 mile radius.
4. **Detachable short- range (hand-held) communicator. Range:** 3 miles.
5. **Video camera (mini)** with both wide and narrow angle lenses. Audio-visual recorder using metal discs with digital meter; lens filters, telescopic lens (480m) and tripod included. Capable of radio telemetry when boosted by long-range radio.

**Cost** is about \$50,000. Poor availability; usually limited to scientific research and the military.

## DETECTION EQUIPMENT

**Amplified Sound Detector:** A unique device designed for professional hunters to hear approaching game. It is also used by the security industry. It is a two-piece unit, consisting of headphones and sound detector, which at first glance, resembles a very large flashlight. Utilizes a built-in, 3½ inch parabolic dish for sound mirro effect. Triples the normal human range of hearing. Weighs about 2lbs (.9kg). **Cost:** \$160.

**Bug Detector:** A small hand-held device that picks up radio signals from listening devices (bugs). **Cost:** \$350.

**Letter Bomb Detector:** An electronic instrument that examines letters in minutes, with an audio alarm that sounds when electrically conductive material is detected. **Cost:** \$700.

**Portable Explosives Detector:** Responds to vapor from explosives, such as dynamite, gelignite, T.N.T. and others. An alarm lamp lights up when an explosive is detected. **Cost:** \$1900. **Range:** 3½ft.

**Radar Signal Detector (military):** This is a mini-radar receiver that can fit in one hand. Small, lightweight, easy to conceal. Recently developed for the U.S. Army. **Cost:** \$3000. **Range:** 80ft (effective range), 4 miles maximum.

**Commercial Radar Detector:** Also known as the "Fuzz Buster" because of its use in detecting police radar scans. **Cost:** \$120.

## EMOTION AND STRESS DETECTORS

**Psychological Stress Evaluator:** This instrument is used by law enforcement agencies, private investigators, some private corporations, clinics and law firms. It functions like a poly-

graph machine, but measures and records stress and anxiety without attaching sensors to the subject. It does this by specifically monitoring the voice quality of its subject. A tape recorder is also a part of the device. **Cost:** \$4000.

**Polygraph Stress Machine:** Sensors are attached to the skin which monitor and record glandular changes (including sweat) in the skin. **Cost:** \$2400.

**Polygraph Stress Monitor:** (superior quality) Sensors are attached to the skin and body which usually record breathing, heart beat/rate, blood pressure, and skin resistance (as described previously). All three functions are fed into a chart recorder, with three pens to mark the results. **Cost:** \$4500.

## PHOTOGRAPHIC EQUIPMENT/FILM/VIDEO AND OTHER OPTICAL EQUIPMENT

35mm Camera	\$250.00
Extra Lenses:	
28mm, F2.8	\$80.00
135mm, F3.5	\$80.00
Flash (average)	\$50.00
35mm Film: Black & White, 36 exposure	\$2.50
Color, 36 exposure	\$4.50
Super 8mm, sound movie camera	\$525.00
Super 8mm film; approx. 15 min. running time	\$8.00
Slide Projector	\$150.00
Projection Screen	\$50.00
VCR Video Recorder	\$500.00
Beta Video Recorder	\$400.00
Video Camera with Tripod	\$2000.00
<b>Full Video Studio</b> with editing, dubbing, optical enhancements, and full film capabilities.	\$180,000 (basic system)
Color Camera with Mike	\$700.00
Videotape Cassette	\$10.00
Telescope, zoom 15-60X power; 1000-4000mm when attached to a 35mm camera	\$190.00
35mm Camera Adapter	\$30.00

## UNDERWATER EQUIPMENT

**Mask, Snorkel and Fin Package: Cost:** \$110.

**S.C.U.B.A. Package:** 80K cylinder with boot, datacom double console (PS1/Depth), regulator, wet suit, pack and power. Oxygen capacity: 90 minutes. **Cost:** \$820.

**Compact S.C.U.B.A.:** A one unit, 2 cubic foot capacity cylinder (air tank) with regulator mounted on top and belt holder. Overall length: 17 inches × 2½ inches wide. Great for short dives or emergency air supply. Oxygen capacity is 15 minutes. **Cost:** \$155.

**Mini S.C.U.B.A.:** (Not commercially available; espionage). This is a tiny air tank and regulator measuring 5 × 2½ inches. Oxygen capacity is a mere FOUR minutes. **Cost:** \$300.

**Diver's Watch:** Multifunctional digital and analog (hands) display, alarm, two time zones, timer, rotating bezel, sweep second hand. **Cost:** \$300.

**Dive Flasher:** A waterproof beacon or rescue marker. Waterproof up to 150ft. Measures 5 × 1½ inches; operates on one "C" battery. **Cost:** \$30.

**Mini Flashlight:** Overall length is 4¾ × ¾ inches; uses 2 "AA" batteries. Features pocket clip, magnetic butt, and screw down



lens to turn it on. **Cost:** \$9.

**8 inch Bowie-style Survival Blade:** With chisel tooth saw, jeweled compass, sheath and belt clip. **Cost:** \$150.

**Underwater Specimen Bag:** Drawstring pouch and shoulder belt. **Cost:** \$16.

**Head Mounted Light:** **Cost:** \$30.

*Also see underwater vehicles.*

## LOCK PICKING TOOLS

**The Pick** can be almost any style or size, but is always a small, thin, steel tool which ends in a slight upward curve or special tip configuration. It is used to raise the pins of the lock so that it will open. A good range of pick thickness is .025-.035. These are available through locksmiths and locksmith suppliers, and some establishments that specialize in rare, hot and illegal items. Cost is usually high. \$4 per pick, with at least a dozen needed for a proper range. **NOTE:** Smiths and suppliers will not usually sell these tools to anyone off the street and may investigate or report the inquiry. However, they are available through mail-order and some supply houses.

**The Tension Bar** is constructed of the same, clock spring steel as the pick and is an "L" shaped tool required (along with the pick) to open locks. It too manipulates the position of the locking pins. **Cost:** \$30 each and is available from the same sources as listed for picks. Prices as contraband, may be as much as 200% higher and purchase from a locksmith or supplier may require a bribe. The size of the picks and tension bars are generally around 3½ to 4½ inches long, rarely larger.

**Basic Lock Pick Set:** Includes one tension bar, key extractor and 9 lock picking tools. **Cost:** \$40.

**Superior Lock Pick Set:** Contains 32 high quality lock picks, bar, tension tools and extractors. **Cost:** \$90.

**Automatic Lock Pick; Release Gun:** This item is only sold to law enforcement agencies at a cost of about \$60. Throws all pins into position at one time and never damages or harms the lock mechanism. Opens all types of locks (tumbler, spool, regular or mushroom). Cost on the street (only 19% chance it is even attainable) — \$120 minimum; may cost as much as 200% more depending on the seller and circumstances.

**Car Openers:** These are a variety of window prying tools. They are fairly easy to find and purchase or construct. A set will cost about \$25.00.

**Old Stand-Bys:** Using sheer force including the cross bar (cost \$12) or drill (cost \$25) or bolt cutters (good for shearing chains, cables and padlocks; **Cost:** \$80).

**Making Key Impressions:** A variety of blank key types are needed. Insert key into lock (grasping tightly with pliers) and turn from side to side. The lock's tumblers will leave marks on the blank where they were rubbing against the impressioning (carbon or boot black) agent. The lock picker now files these impressions somewhat. Reinsert, file some more, and repeat the procedure until the key is completed and works.

**Note:** The player must roll under his lock pick skill proficiency for each insertion. One failure botches the entire job and six insertions are required. This is a lengthy process taking 15 to 20 minutes. **Cost** of key blanks are high because they must be obtained in the same way as the picks. **Average Cost:** \$30 per blank.

**Lock File:** Costs about \$10-\$15.

**Note:** Only characters with a skill in picking locks can use these tools or any of the picking tools listed.

## FIELD EQUIPMENT

### Hunting, Trapping Camping

Back Pack — Small	\$120.00
Back Pack — Large	\$210.00
Canteen: Plastic	\$20.00
Canteen: Aluminum	\$30.00
Compass	\$50.00
Disposable Lighter	\$1.00
Flashlight	\$15.00
Insect Repellent	\$4.00
Knife: Small	\$10.00
Knife: Large	\$20.00
Knife: Survival	\$120.00
Rope — Per 20ft	\$20.00
Rope Ladder — Per 10ft/3m	\$40.00
Light Chain — Per foot	\$2.00
Heavy Chain — Per foot	\$6.00
Tent — One Man	\$110.00
Tent — Two Man	\$180.00
Tent — Four Man	\$260.00
Tent — Military Command Post (25lbs, 8 × 8ft floor, 5ft ceiling; camouflage, green or khaki)	\$400
Tent Canvas — Per sq yard/meter	\$20.00
Mosquito Netting — Per sq yard/meter	\$12.00
Hammock	\$50.00
Sleeping Bag	\$150.00
Blanket — Light	\$10.00
Blanket — Heavy	\$20.00
Pillow	\$10.00
Utensil Kit (knife, fork, spoon set with sheath)	\$25.00
Tackle Box	\$20.00
Bow Hunter Accessory Bag	\$40.00
Fishing Rod and Reel	\$50.00
Fishing Net	\$20.00
Snare Cord — Per sq yard/meter	\$5.00
Beaver Trap	\$60.00
Rabbit Trap	\$40.00
Bear Trap	\$180.00
Wolf Trap	\$160.00
Fishing Line — Per 50ft	\$5.00

**Climbing Platform:** Used by deer hunters to help climb and stand in trees. Gets them above the line of sight and reduces the chance of being scented. Portable; 100% high carbon steel.

**Small** — 16 × 19in platform — 200lb capacity \$40.00

**Medium** — 17 × 24in platform — 250lb capacity 60.00

**Heavy** — 20 × 26in platform — 1000lb capacity \$80.00

**Grappling Hook and Line** — 250ft \$80.00

**Full Rappelling Equipment:** Including spikes, mallet, hooks, pulley, straps, harness, gloves, boots, black pack, etc. \$1100.00



## CONTAINERS

Saddlebag (horse)	\$100.00
Small Pocket Purse	\$5.00
Belt Purse (attaches to belt)	\$10.00
Shoulder Purse — Small	\$20.00
Shoulder Purse — Large	\$35.00
Small Sack	\$6.00
Large Sack	\$15.00
Knapsack	\$25.00
Back Pack	\$60.00
Cloth Handle Bag	\$10.00
Tobacco Pouch	\$20.00
Waterskin — 2 pints	\$20.00
Waterskin — ½ gallon	\$30.00
Waterskin — 1 gallon	\$50.00
Cask, Wooden — 4 gallons	\$30.00
Cask, Wooden — 10 gallons	\$40.00
Cask, Wooden — 25 gallons	\$60.00
Vial, Glass — 2 ounce	\$4.00
Jar, Glass — 1 pint	\$4.00
Jar — 2 pints	\$2.00
Jar — 4 pints	\$4.00
Jar — 1 gallon	\$10.00
Jug — ½ gallon	\$20.00
Jug — 1 gallon	\$35.00
Jug — 5 gallons	\$60.00
Small Wood Crate	\$20.00
Medium Wood Crate	\$30.00
Large Wood Crate	\$50.00
Trunk, Small Wood — 25lbs — 30 S.D.C.	\$80.00
Trunk, Large Wood — 50lbs — 70 S.D.C.	\$200.00
Small Metal Security Box — 5lb — 30 S.D.C.	\$40.00
Large Metal Security Box — 15lbs — 90 S.D.C.	\$80.00
Metal Trunk, Small — 35lbs — 100 S.D.C.	\$250.00
Metal Trunk, Large — 80lbs — 200 S.D.C.	\$500.00
Small Safe — 50lbs — 350 S.D.C.	\$900.00
Large Safe — 300lbs — 1000 S.D.C.	\$2000.00

## MISCELLANEOUS EQUIPMENT

- Bullet Resistant Attache Case:** A.R.: 15, S.D.C.: 140. Cost: \$440.00.
- Courier Briefcase:** A.R.: 11, S.D.C.: 90. Cost: \$225.00.
- Acoustic Noise Generator:** Muffles conversations, distorts bugging systems by 30%. Cost: \$900.00.
- Camouflage Paint Kit:** 4 spray cans plus 6 stencils allow for easy camouflaging of vehicles, bunkers, and any field equipment. One kit will cover approximately 100 square feet of surface. Available in jungle, forest or arctic. Cost: \$35.00.
- Camouflage Tape:** The ever popular duct tape. Comes in rolls 26ft long and two inches wide. Available in jungle, forest or desert camouflage, or in olive drab. Cost: \$6.00 per roll.
- Camouflage Compact:** A one-man kit for camouflage or night operations. Includes enough face and hand paint for 6 applications. Mirror, brush and disposable cleaning pads are also included in a neat, black case, 4 inches in diameter and ½ inch high. Cost: \$18.00 each.
- Climbing Kit:** A complete set of equipment for rappelling, rock scaling or climbing. Includes 3,600ft reels of 4500 test

rope (each reel weighs 40lbs). An adjustable harness with clamps, 6 pairs of canvas climbing gloves. 48 clamps, 48 fasteners, 48 pitons, 3 hammers, 2 grappling hooks, and one pulley. Weight with shipping crate is 190lbs. Cost: \$1100.00.

**Ear Protector Headphones:** The answer to the Demo expert's and grenadier's dreams. The same model is used by airport workers to preserve hearing in noisy environments. Cost: \$35.00.

**Electro-Adhesive Pad:** This is a hand-held device that will adhere strongly to any metal surface by means of passing a small current through two metal electrodes. These pads are commonly used by astronaut's and can be used in astronaut's shoes, but the hand-held pads are much more flexible and generally preferred. Cost of the Electro-Adhesive Pads (2) and generator (hip or back-pack): \$40,000. In shoe form: \$50,000. Can hold up to 1000lbs; works *only* on metal. Not commonly available.

Flashlight — Small	\$5.00
Flashlight — Medium	\$10.00
Flashlight — Large	\$15.00
Flashlight — Unbreakable (Kel-lite):	
Small	\$24.00
Medium	\$28.00
Large	\$32.00
Very Large	\$35.00

**Rechargeable, unbreakable flashlight** that's 10 times brighter than most conventional types; quartz-halogen bulb, 12 inches (0.3m), 1.8lbs, 20,000 candle power. Cost: \$130.00, or 35,000 candle power — cost: \$160.00.

<b>Portable Halogen Spotlight:</b> 50,000 candle power	\$30.00
Treated Torch	\$8.00
Candle Stick — Per Doz.	\$8.00
Oil Lantern — 6 hours/1 pint	\$20.00
Oil Lantern — 12 hours/2 pints	\$30.00
Oil Lamp — 6 hours	\$30.00
Padlock — Light — 25 S.D.C.	\$5.00
Padlock — Medium — 50 S.D.C.	\$8.00
Padlock — Heavy — 75 S.D.C.	\$15.00
Padlock — Burglar proof, 60% to be picked 80 S.D.C.	\$30.00
Handcuffs — Regular — 60 S.D.C.	\$25.00
Handcuffs — Heavy — 120 S.D.C.	\$50.00

**Medical Bag:** This 8lb bag is a complete Medic's field kit. Included are adhesive pads, bandages, gauze pads, adhesive tape, splints, sterile gloves, scissors, forceps, thermometer, needle, razor blades, pins, medicine, ointment, and salt tablets. Bag has back pack and shoulder straps, and is available in choice of camouflage, green or khaki. Cost: \$275.00.

**Professional Medical Kit:** A comprehensive first aid kit that contains six doses of each of the following: Antibiotics, anti-inflammatories, sedatives, painkillers. Assorted mini-instrument pack with scalpels, scissors, probes, etc.; a dozen in all. Tape, bandages, sutures, and four air filters. Cost: \$200. Available on the open market, without the drugs, at a cost of \$1500.

**Machete:** Complete with canvas sheath. 1D6 damage. Cost: \$30.00.

**Wirecutters:** 8 inch wirecutter has nonconducting handles to avoid the nasty "shock" of electrified fences. Complete with belt sheath. Cost: \$65.00.



**Rations:** Dry field rations; each 15lb case includes 12 meals. Crate is stocked with 12 cases, and has a total shipping weight of 200lbs. **Cost:** \$470.00.

**Food Ration Packs:** A food pack contains enough concentrated, vitamin enriched, freeze-dried rations to easily last two weeks. The food supply can be stretched to last four weeks if necessary. Geared for two-man consumption. **Cost:** \$2000. Limited availability.

**Padded Helmet:** A.R.: 10, **Cost:** \$25 to \$75.

**Protective Goggles or Tinted Visor:** Designed for use outdoors or for welding. Unbreakable plastic lenses. **Cost:** \$20.

**Face Protector and Gas Mask:** The mask can attach to most standard helmets, providing added protection to the face and eyes. Tinted visor and detachable air filter are standard. **Cost:** \$200. With gas mask modification and independent oxygen supply (2 hours): \$600.

**Conventional Air Filter:** Fits over nose and mouth. **Cost:** \$75.

**Conventional Gas Mask:** With a superior filtering system. **Cost:** \$100.

**Gas Mask** will filter out CS, smoke and a variety of military gases. Note: Not recommended as protection against nerve gas or radiation. **Cost:** \$50.00.

Sunglasses — Light Adjusting \$25.00  
Sunglasses — Aviator \$45.00

**Shooting Glasses:** Change color and density in response to changes in light and weather. Also reduces glare and improves visibility. **Cost:** \$72.00.

Protective Goggles \$10.00  
Basic Phone \$50.00  
Telephone Answering Machine \$120.00  
Tape Recorder — 30-60 min. recording time; pocket size \$100.00

Basic Computer \$650.00  
IBM Compatible (MS Dos) \$1800.00  
IBM Computer (top of the line) \$20,000  
Monitor — Black and White \$100.00  
Monitor — Green or Amber \$250.00  
Monitor — Full Color \$800.00  
Basic Printer \$250.00  
Letter Quality Printer \$650.00  
Laser Printer (top quality) \$2800.00  
Telephone Modem \$150.00

**Jet Pack:** Speed: 80mph maximum, **Duration of Flight:** 40 minutes maximum. Jet Pack S.D.C.: 100. **Maximum Height:** 300ft. **Cost:** \$80,000.00. **Fuel Cost:** \$500.00 per tank (40 minute flight capacity).

**Space Suit:** (complete) Self contained environmental suit, insulated, heat and cold shielded, oxygen and life support system; the whole works. **Cost:** \$250,000.00.

## ACIDS

**Organic Acid:** (affects only organic substances) Does 2-12 damage each melee for a total of four melees.

**Organic Acid:** (concentrated) Does 4-24 damage per melee for a total of four melees.

**Cleanser:** Does 2-12 damage to organic; 1-6 damage to all other substances.

**Metal Dissolver:** (industrial) 4-24 damage per melee for a total of four melees. Does 1-8 damage per melee for a total of four melees to organics and plastics.

All acids are not common household items and must be acquired from a chemical supplier, industry or an illegal outlet. In the first two cases, large bulk orders may be required, and in the latter case, availability is extremely low (9% chance of getting the item) and multiply the cost ten times.

**Costs:** Organic I — \$75.00 per ½ gallon. Organic II — \$120.00 per ½ gallon. Cleanser — \$180.00 per ½ gallon. Metal Dissolver — \$600.00 per ½ gallon.

**Nylon Cord:** A variety of heavy-duty, all-purpose, nylon rope or cord is available. Average tension strength is 600lbs (270kg). Average length is 300ft (90m), at a cost of about \$100. Good availability.

## CLOTHING

### COMBAT/HUNTING

**Police Style Jumpsuit:** One-piece, zippers down the middle; large zippered chest pockets (2), front pockets (2), rear pockets (2), pencil/pen slot (left arm), sleeves and leg cuffs zipper for adjustability, bi-swing pleated back, and padded knees. **Cost:** \$80.00

**Heavy Camouflage Coveralls:** (Jumpsuit style) Insulated lining for cold weather (above freezing level cold), wrist and ankle elastic for tight fit, 6 pockets (chest, hip, rear).

Tiger Stripe Camouflage \$80.00  
Tree Bark Camouflage \$85.00  
Black or White \$75.00  
Green \$75.00

**Light Camouflage Coveralls:** (Jumpsuit style) Cotton and polyester blend.

Tiger Stripe Camouflage \$50.00  
Tree Bark Camouflage \$60.00  
Black or White \$45.00  
Green \$45.00

**3-D Camouflage Suit:** A multi-shade of drab green and brown, with approximately 250, individual hanging strips to blend into the foliage. Bonus: +10% on prowl skill when in woodland environment. **Cost:** \$150.00.

**Below 30 Degree Coveralls:** Insulated for prolonged exposure in the extreme cold, with thick, turtleneck collar that covers chin, nose, and mouth. The outer fabric is an acid resistant, cotton/polyester twill; has zippers at leg bottoms for easy removal; knit, windproof cuffs; sleeve pockets (one each arm) and six large pockets. Comes with zip-off hood. Suitable for up to 20 degrees below zero Fahrenheit. **Cost:** \$80.00.

**Work Overall:** (Jumpsuit Style) **Cost:** \$40.00

**Expendable Lab Coat or Coveralls:** Made from a special non-woven fabric that is acid, grease and lint resistant. Can be worn once or a dozen times, then thrown away. **Cost:** \$6.00.

**Battle Dress Uniform (Fatigues):**

**Pants:** 6 pockets, adjustable waist tab, button fly, drawstring cuffs.  
Tiger Stripe Camouflage \$30.00



Tree Bark Camouflage	\$35.00
S.W.A.T. Black	\$30.00
Olive Green	\$30.00
White or Khaki	\$30.00

**Shirts:** (4 Pockets)

Tiger Stripe Camouflage	\$30.00
Tree Bark Camouflage	\$30.00
S.W.A.T. Black	\$25.00
Olive Green	\$20.00
White or Khaki	\$20.00

**Military Field Jacket:** Includes adjustable collar and cuffs, epaulets, 4 large outer pockets with heavy brass zippers, hidden hood, waist cord and snap closures. **Cost:** \$60.00.

**Reversible Flight Jacket — Light:** Comes in navy blue, grey, green and brown. **Cost:** \$50.00.

**Extreme Cold Weather Flight Jacket:** (heavy, insulated) Comes in navy blue, grey, green, brown and white. **Cost:** \$100.00.

**Battle Dress Utility:** Shirt and pants in choice of arctic, desert, jungle or autumn forest camouflage. Shirt has two breast pockets, one pen pocket, and one (left-side) interior pocket. Pants equipped with hip, butt and thigh pockets. Lightweight (desert and jungle): \$65.00. Medium Weight (forest and mountain): \$90.00. Arctic Weight (down lined): \$365.

**Battle Jacket:** Comes equipped with breast, hip and interior pockets on both sides. A hidden pocket on the inside of the back is also useful. Available in camouflage, khaki, green or black. **Cost:** \$225.

**Arctic Parka:** High quality down lining provides protection in sub-zero conditions. Same pocket arrangement as Battle Jacket. Available in green and white only. **Cost:** \$450.

**Wool Sweaters:** Finest British quality knit with leather reinforcements at shoulders, elbows and neck. Available in cream, green or black. **Cost:** \$150.00.

**Ponchos:** Waterproof nylon. Useful for rain protection, ground cover, emergency tent, etc. 5ft by 5ft square. Available in camouflage. **Cost:** \$35.00.

**Camouflage T-Shirt.** **Cost:** \$8.00.

**Khaki Bush Shorts.** **Cost:** \$20.00.

## HATS & HEAD COVERINGS

**Police Style Riot Helmet:** With ventilated transparent face shield. **Cost:** \$60.00.

**Combat Helmet:** Complete with liner and camouflage cover. **Cost:** \$40.00.

**Safari Hat:** A wide-brimmed hat perfect for shading the eyes in tropical sunlight and classy enough for an evening out on the town. Fasteners on each side for an easy 'Aussie style' flip. Available in choices of camouflage, cream, green, or khaki. **Cost:** \$125.00.

**Utility Cap:** A classic 'marine cover'. Available in choice of camouflage, green or khaki. **Cost:** \$14.50.

**Beret:** The classic wool beret. Available in green, black, or jungle camouflage. **Cost:** \$20.00.

**Bandanna:** In choice of colors. **Cost:** \$5.00.

**Head Net:** Covers hair and face, leaving only a slit for the eyes. **Cost:** \$15.00.

Camouflage Face Veil \$15.00

**Navy Style Face Mask:** Water and wind proof vinyl with soft wool lining; mouth tab with snap closure. **Cost:** \$8.00.

## CLOTHES: GENERAL PURPOSE

**Dancer's Leotards** \$40.00

**Speed Suit:** (Jumpsuit Style). Trim cut, polyester/cotton fabric with one breast pocket and two front pockets. Used by race car drivers and pit crews. **Cost:** \$35.00.

Shop Service Coat: knee length, 4 pockets \$30.00

Turtleneck Shirt \$15.00

Thermal Parka, Hooded Sweat Shirt \$25.00

Sweat Shirt \$16.00

Flannel Shirt \$14.00

T-Shirt \$6.00

Dress Shirt \$40.00

Work Pants \$25.00

Denim Jeans \$30.00

Coveralls — Work \$35.00

Coveralls — Insulated \$60.00

Work Apron — Denim, 3 pocket \$12.00

Machinist's Apron — 6 pocket \$18.00

Lab Coat \$40.00

Windbreaker Jacket \$18.00

Light Lined Jacket \$30.00

Winter Jacket — Waist Length \$55.00

Winter Jacket — Hip Length \$80.00

Reversible Hunting Parka \$70.00

Insulated Survival Vest — 6 pocket \$50.00

Survival Coat — Insulated — 4 big pockets and hood \$100.00

Wool Cap \$80.00

Winter Ski Mask \$10.00

Arctic Trooper Hat with Fur Earflaps \$15.00

Work Gloves \$4.00

Leather Racing Gloves \$25.00

Dress Winter Gloves \$20.00

Heavy Winter Gloves \$15.00

Wool Mittens \$14.00

Leather Chopper Mitts \$20.00

Lectra-Mitts — Warmest Hand Protection Possible \$30.00

Tennis Shoes \$16.00

Running Shoes \$30.00

Work Shoes \$40.00

Dress Shoes/Boots \$80 +

Steel Toe Shoes \$35.00

Steel Toe Boots \$60.00

Work Boots \$50.00

Waterproof Hunter's Boots \$40.00

High Quality Hunter/Woodsman, insulated boot \$140.00

Waterproof Rubber Boots: Ankle High \$20.00

Hip High 50.00

Rain Poncho \$30.00

Raincoat \$30.00

Rain Suit — Coat & Pants \$45.00

Rain Hat \$8.00

Hard Hat \$10.00

Sport Caps \$10.00

Baseball Cap \$8.00

Hat — Short Brim \$40.00

Hat — Large Brim \$50.00

Hat — Leather, large brim \$50.00



Cape — Short	\$60.00
Cape — Long	\$150.00
Cape — Long and Hooded	\$175.00
Robe — Light	\$30.00
Robe — Heavy	\$60.00
Robe — Hooded	\$80.00
Bathrobe	\$25.00

**Note:** Generally double or triple the price for fancy/dress articles and multiply the price by 10 times (or more, in some cases) for custom-made articles.

### Security Guard Uniform

*Usually Navy Blue or Brown Color*

Jacket	\$35.00
Shirt	\$18.00
Tie	\$4.00
Trousers	\$25.00
Regulation Hat	\$15.00
Trouser Belt	\$10.00
Traditional belt and holster with 28 bullet loops	\$60.00
Badge and I.D. Pocket Case	\$18.00

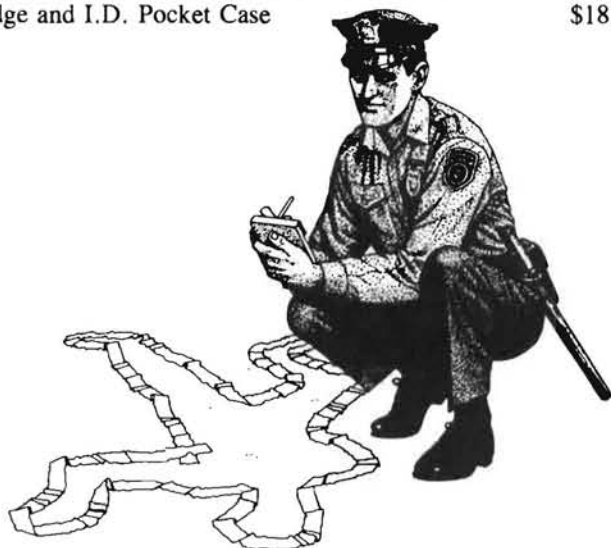

## CONVENTIONAL VEHICLES

### TYPICAL CONSUMER AUTOMOBILES:

**Compact:** A.R. 5, S.D.C. 300, Speed: 110mph (176.9kmph), Range: 350 miles (563km). **Cost:** \$6,500. and up.

**Mid-Size:** A.R. 6, S.D.C. 350, Speed: 110mph (176.9kmph), Range: 300 miles (482km). **Cost:** \$9,500. and up.

**Full-Size Sedan:** A.R. 7, S.D.C. 450, Speed: 120mph (193kmph), Range: 250 miles (402km). **Cost:** \$15,000. and up.

**Luxury Sedan:** A.R. 7, S.D.C. 450, Speed: 120mph (193kmph), Range: 250 miles (402km). **Cost:** \$25,000. and up. American and Japanese.

**Sports Car:** A.R. 5, S.D.C. 350, Speed: 120mph, unmodified, but can be supeed to 180mph, Range: 200 miles (321km). **Cost:** \$20,000. and up.

**Corvette:** A.R. 5, S.D.C. 300, Speed: 120mph, Unmodified, Range: 270 miles (434km). **Cost:** \$15,000. and up.

**Mini Van:** A.R. 6, S.D.C. 350, Speed: 120mph (193kmph), Range: 350 miles (562km). **Cost:** \$15,000. and up.

**Full-Size Van:** A.R. 7, S.D.C. 400, Speed: 120mph (193kmph), Range: 200 miles (321km). **Cost:** \$9,000. and up.

**Jeep (4 wheel drive):** A.R. 6, S.D.C. 300, Speed: 120mph (193kmph), Range: 400 miles. **Cost:** \$12,000. and up.

**Small Truck (4 wheel drive):** A.R. 6, S.D.C. 350, Speed: 120mph (193kmph), Range: 400 miles. **Cost:** \$10,000. and up.

**Small Truck:** A.R. 6, S.D.C. 300, Speed: 120mph (193kmph), Range: 300 miles (482km). **Cost:** \$8,000. and up.

**16ft Truck (U-Haul type):** A.R. 7, S.D.C. 400, Speed: 120mph (193kmph), Range: 200 miles. **Cost:** \$20,000. and up.

**24ft Truck (U-Haul Type):** A.R. 8, S.D.C. 500, Speed: 120mph (193kmph), Range: 190 miles (305km). **Cost:** \$50,000. and up.

**Semi-Truck (Cab only):** A.R. 10, S.D.C. 600, Speed: 120mph (193kmph), Range: 150 miles (241km). **Cost:** \$90,000. and up. Add another \$90,000 for the cargo bed (trailer).

### FOREIGN AND SPORTS CARS

**BMW Sedan:** German. A.R. 6, S.D.C. 350, Speed: 140mph (225kmph), Range: 250 miles (402km). **Cost:** \$80,000. to \$150,000.

**BMW Sports Car:** German. A.R. 5, S.D.C. 325, Speed: 180mph (290kmph), Range: 200 miles (321km). **Cost:** \$90,000. and up.

**Delorean:** Irish. A.R. 6, S.D.C. 325, Speed: 140mph (225kmph), Range: 200 miles (321km). **Cost:** \$60,000.

**Jaguar:** A.R. 5, S.D.C. 300, Speed: 180mph (290kmph), Range: 200 miles (321km). **Cost:** \$80,000.

**Lamborghini — Contac:** Italy. A.R. 5, S.D.C. 300, Speed: 200mph + (321kmph), Range: 220 miles (355km). **Cost:** \$150,000. and up.

**Mercedes Benz Sedan:** German. A.R. 6, S.D.C. 350, Speed: 140mph (225kmph), Range: 250 miles (402km). **Cost:** \$90,000 to \$150,000. and up.

**Mercedes Benz Sports Car:** German. A.R. 6, S.D.C. 300, Speed: 200mph + (321kmph), **Range: 220 miles (355km).** **Cost:** \$100,000. and up.

**Porsche:** Italy. A.R. 5, S.D.C. 300, Speed: 200mph + (321kmph), Range: 200 miles (321km). **Cost:** \$65,000. and up.

**Rolls Royce Luxury Sedan:** Great Britain. A.R. 6, S.D.C. 450, Speed: 120mph (193kmph), Range: 190 miles (305km). **Cost:** \$100,000. and up.

**Volvo Sedan:** A.R. 5, S.D.C. 300, Speed: 140mph (225kmph), Range: 250 miles (402km). **Cost:** \$45,000. and up.

### MOTORCYCLES

**Motorcycle — Light:** A.R. 5, S.D.C. 50, Speed: 90mph (144kmph), Range: 120 miles (193km). **Cost:** \$500.00 and up.

**Motorcycle — Medium:** A.R. 5, S.D.C. 100, Speed: 110mph (176kmph), Range: 350 miles (562km). **Cost:** \$1,800.-\$2,500.

**Motorcycle — Heavy:** A.R. 5, S.D.C. 150, Speed: 120mph (193kmph), Range: 350 miles (562km). **Cost:** \$5,500.-\$10,000.



## AIRPLANES

**Single Engine:** A.R. 4, S.D.C. 400, Speed: 300mph (482kmph), Range: 680 miles (1040km).

**Twin Engine:** A.R. 5, S.D.C. 550, Speed: 420mph (670kmph), Range: 600 miles (964km).

**Small Jet:** A.R. 5, S.D.C. 850, Speed: 600mph (960kmph), Range: 1370 miles (2205km).

## UNDERWATER VEHICLES

**S.C.U.B.A. Scooter:** Capable of pulling one to three divers.

The handles are designed for pulling the divers with minimum stress on the arm muscles. Cylindrical in shape with a front mounted rotor. Length: 3ft 1in (0.94m), Width: 1ft 5in (0.32m), Height: 10 inches (0.25m), Weight: Dry — 57lbs (26kg), Submerged — 5oz (0.23kg). **Maximum Depth:** 300ft. **Range:** 3 nautical miles. **Speed:** 3 knots. Can function on the water's surface or submerged. **S.D.C.:** 50.

**S.C.U.B.A. Scooter Platform:** Essentially a larger, more stable version of the little scooter. Unlike the small scooter, a diver can lay on top of the device to ride. The basic purpose is to carry S.C.U.B.A. divers and their equipment into the sea and return them safely. It can also serve as a stable platform (precisely controlled) for underwater photography. Length: 9ft 3in (2.8m), Width from side fin tip to fin tip is 4ft (1.2m), Weight: 270lbs — Dry, 181lbs submerged. **Maximum Depth:** 1970ft (600m). **Speed:** 5 knots. **Range:** 15 nautical miles. Accommodates one pilot, but can pull up to four more divers (cargo capacity is 1000lbs/450kg). **S.D.C.:** 120.

**Sea Sled or CAV (Construction Assistance Vehicle),** is designed to function as an underwater pickup truck capable of delivering up to 2000lbs (910kg) of wet weight cargo. The cockpit holds two, and has with it an open cargo bed in the rear. Length: 27ft (8.23m), Cargo bed dimension: 11×4.5×1.5ft (3.35×1.37×0.46m). **Maximum Depth:** 150ft (45.7m), **Speed:** 3 knots, **Range:** 15 miles (24km). **Life Support:** 5 compressed air bottles, 2 hour air supply. Can function on the surface or submerged. **S.D.C.:** 270.

**Waterdinger:** A small, diver assist vehicle capable of carrying two S.C.U.B.A. divers and equipment. Length: 7ft (2.1m), **Cargo Capacity:** 750lbs — Dry (340kg), **Maximum Depth:** 300ft (91m), **Speed:** 2 knots, **Range:** 4 nautical miles. **S.D.C.:** 150.

**Two Diver Submersible Transport Vehicle:** There are a variety of two-man, research submersibles with similar capabilities. Length: 12 to 16ft (3.6m to 4.9m). **Maximum Depth:** 2000ft (610m). **Speed and Range:** at 1.5 knots the range is 100 miles (160m), at 6 knots the range is about 45 miles (72km) and at 9 knots the range is 10 miles (16km). **Life Support Endurance:** 18 hours plus 6 hours emergency. **S.D.C.:** 550.

## SPECIAL GIMMICKS

- 1. Tailor-Made Clothing** with *secret pockets* and seams for concealment. For example, a seam or cuff can be designed to hold wire or a small tool. The same is true with tiny pouches and pockets carefully designed to be invisible upon quick examination. **Note:** These are small, flat pockets designed for small/tiny implements that might not be felt in a body search. Guns or wallets will be far too bulky. **Cost:** Add \$50 for *each* hiding place/pocket and \$100 to the overall cost of the clothing.
  - 2. Belt Buckle Compartment.** **Cost:** \$35.
  - 3. Belt with a Secret Lining** to hold wire, keys and small, flat tools. **Cost:** \$50.
  - 4. Flash Powder:** A simple chemical reaction causes the powder to ignite in a blinding flash and a small puff of smoke. Does no damage, but everyone exposed to the flash (within 12ft) loses initiative. **Cost:** \$20 per ounce.
  - 5. Itching Powder:** Makes its victim itchy and uncomfortable. Lasts 1D4 hours or until washed off. Affects only bare skin. Victims are annoyed and distracted; -4 on initiative. **Cost:** \$10 per ounce.
  - 6. Goblin Dust:** Often a homemade powder composed of fine soot, ash and dirt. The dust is usually packaged in small packets that can be torn and thrown or blown in an opponent's face. Large paper bags can be filled and used to hit an opponent like a club, breaking open and dumping in the persons face. There's a 45% chance of getting the dust in the person's eyes and blinding him for 1D4 melees (-6 to strike, parry and dodge). **Cost:** About two bucks for a five pound batch.
  - 7. Mini-Smoke Bomb:** A small, golf ball size and shaped item, easy to conceal or palm, that emits a cloud of smoke that fills a 10 foot (3m) area. Colors include: grey, black, yellow, red, white and green. **Cost:** \$5 each.
  - 8. Mini-Stink Bombs:** These look just like the smoke-bomb, but emits a cloud of horrible stench. Fills a 10ft area and lasts 1D6 minutes. This stench is 20 times worse than the commercial prank types. Victims will involuntarily gag, eyes will water and some may even vomit. Unless a savings throw is made, the people exposed to the stench will forfeit half their attacks that melee and run out of the area. Characters who endure the stench, but fail to save, lose two melee attacks and are -1 to strike, parry and dodge. A successful save means the stench has no significant effect. Savings throw: 16 or higher. **Cost:** \$30 each.
-











# BEYOND THE SUPERNATURAL™

A Role-Playing Game of Contemporary Horror

*Highlights Include . . .*

- A New Magic System For A Contemporary World.
- Ancient Mystic Arts
- Places of Power
- Psychic Abilities
- Supernatural Creatures
- Everything You Need to Play.
- A Complete Role-Playing Game of Horror.

ISBN 0-916211-18-5



9 780916 211189



\$24.95

Cat. No. 700

I.S.B.N. 0916211-18-5