

Done's

BLACK & WHITE

DUNGEON OF TERROR #7 MAD MAGE CHAMBERS (SOUTH)



Øone's BLACK & WHITE

Welcome

This product line will bring you simple tiles for your favorite RPGs. In each product you will find a whole fantasy location fully fleshed out in miniature-scale tiles with the usual Øone's top-notch customization capabilities. The B&W maps are simple, line art battlemaps you can customize to suit your needs and then print. These tiles are accurate, detailed, inexpensive and no ink-eaters.

In each B&W product you'll find:

- A Referee map detailing a fantasy location
- The whole location broken in US Letter sheets in miniature scale (each sheet contains a 8x10 inches tile)
- A short description of each area of the location with suggested plots

The Rule the Dungeon® Feature

This Øone's exclusive feature allows you to customize the look of your map by adding the furniture, toggle the grid, hide the room numbers and much more.

On the Referee Map, you will find a big "Rule the Dungeon" button. This button will not be printed, so, don't mind if it overlaps something on the map. By clicking on this button some options will be shown, as detailed below. A checkmark will appear beside the options active.

The options available could vary with products, below is a list of the most common options included in B&W products:

- **Text:** toggle room numbers and tile numbers.
- **Tiling:** toggle the page tiling (Referee Map only)
- **Furniture:** toggle furniture
- **Doors:** toggle doors
- **Square/Hex Grid:** toggle square grid and hexagonal grid
- **No Grid:** turn off the grid
- **Black Fill:** toggle the black in the walls
- **Grey Fill:** toggle the grey fill in the walls
- **No Fill:** toggle the white fill in the walls
- **All:** toggle default state/empty state (with just the walls).

Note that the Rule the Dungeon button on the Referee Map controls all the battlemaps at once.

How to Use This Product

Click on the big button of the Referee Map to customize your maps. Once you have obtained the desired appearance (note that room numbers and tiling do not appear on the tiles) simply choose "Print" from the Acrobat menu.

If you need to print only some tiles, simply click on the desired tile on the Referee Map and choose "Print this Tile".

Tips for Printing

The tiles should have enough margins to print without checking the option "fit to page". If your printer has a margin larger than ¼ inch you should check it in order to print the whole tile. This could reduce slightly your tile but it should be easily usable.



Øone Roleplaying Games
www.Øonegames.com
master@Øonegames.com

Øone's Black & White: Dungeon of Terror #7
Mad Mage Chambers (South)
Product Code: bew010. First edition 09/2009
Design: Mario Barbati
2D drawings: Mario Barbati
Graphics: Ø'Bully
Software Engineer: Anna Fava

All of the content of this book is © by Øone Roleplaying Games. The reproduction or retransmission of any part of this book, without written permission of the copyright holder is expressly forbidden, except for the purpose of reviews. Permission is granted to print this book for personal use only.

Øone's
BLACK & WHITE
LAIR OF THE
BLACK CULT

DETAILED
INEXPENSIVE
CUSTOMIZABLE
NO INK-EATING

www.Øonegames.com

DUNGEON OF TERROR #7

MAD MAGE CHAMBERS (SOUTH)

Welcome to **DUNGEON OF TERROR**, the largest dungeon ever tiled!

DUNGEON OF TERROR contains **164** rooms, **8** different zones (each one featured in a single product) and it's broken in **225** customizable tiles.

You can play **DUNGEON OF TERROR** as a whole dungeon or extract your favorite sub-dungeon (or even a single room or encounter area) to suit your campaign. If you're bold, you can lay down a massive **120x150** inches dungeon to play the most extended miniature-scaled dungeon crawl of the history!

The Story

The Dungeon of Terror was in origin an ancient mine, built by a now disappeared dwarven clan. It is said the dungeon was eventually conquered by an evil mage called Infidus the Black.

Infidus was mad, and he enjoyed filling the dungeon with all sort of magical devices and trying all sort of magical experiments. During his reign, no one dared to enter the Dungeon of Terror, since those who entered, never came out.

The dungeon remained unconquered until a single talented assassin managed to get past the dungeon defenses and penetrated the mad mage's sanctuary, down in the last level of the dungeon, killing him in the sleep.

Nobody knows the fate of the assassin. Someone speculates the assassin was crushed by the dungeon defenses while tried getting out, others say he became so rich to buy a whole reign and crowned himself king, some others say the mage became a lich and trapped the assassin for the eternity within the dungeon.

However, after Infidus death, the dungeon became target for new, evil inhabitants. Slowly, monsters moved into the magical halls breaking their defenses and looting their treasures. Most of the chambers remain actually unconquered and are known today as "The Mad Mage Chambers". (Featured in *Dungeon of Terror* #3, #5 and #7)

It is known that a feared orc tribe, worshipping the one-eyed god, dwells in the northernmost part of the dungeon. They are led by a cruel, black-skinned giant orc called Kruedgoor. (Featured in *Dungeon of Terror* #1)

The northwestern part of the dungeon was claimed by a brotherhood of assassins. The assassins made here their hideout and perform all sort of evil and illegal activities, including slavery, torture and worse. (Featured in *Dungeon of Terror* #2).

Featuring one of the two entrances to the Dungeon, on the west side you can find an area called The Maze. It is said that the spirit of a powerful minotaur, once enslaved by Infidus, roams this labyrinth. (Featured in *Dungeon of Terror* #4)

Just south of the other entrance on the east side of the dungeon an undead area is found. This is the domain of Alserlak the Lich and of his wife Varlania the Vampiress, said to keep a "secret written in the books". The powerful couple has legions of undead at their orders and rarely other inhabitants of the dungeon dare to enter their rotten halls. (Featured in *Dungeon of Terror* #6)

In the southeast part of the dungeon there are natural cavern, which maybe existed before the dwarven colonization. Occasionally these caverns are visited by a band of smugglers and clandestine brewers who settled there their brewery. It is said the underground lake is also the home of a ferocious aquatic troll. (Featured in *Dungeon of Terror* #8)

Mad Mage Chambers (South)

Just south of the western entrance of the Dungeon of Terror you can find another set of almost unconquered halls, designed by Infidus the Black. Actually, three powerful individuals, a witch, a necromancer and a drow priestess, managed to discover and bypass some of the ancient traps of the dungeon.

The vicious drow priestess Ingrlai, discovered the sole mean to pass through the so-called Hall of Watching Thrones. This hallway, connecting the north chambers, contains many thrones, each one with a different item sitting over. It is said that if the items do not stand in a particular configuration a powerful bloodthirsty demon is released. The priestess built her sacrificial altar in the chamber just south of the Hall of Watching Thrones.

Zirdan the necromancer and Wikka the witch, fought a fierce battle for months. Eventually they come to a treat and discovered they could help each other. Wikka kidnaps unwary people for her pleasure and once finished with them sell them to Zirdan who, in turn, employs the corpses in his foul experiments.

It is worth to mention that some areas remains unconquered, such as the Chess Chamber, the King's Hall and the Perpetual Explosion Hall.

Mad Mage Chambers (South) Rooms

117. Empty (Tile #182)
118. Armored Knight's Last Stand (north) (Tile #181)
119. Armored Knight's Last Stand (south) (Tile #181)
120. Empty (Tile #198)
121. Chess Chamber (Tiles #196, 197, 211, 212)
122. Perpetual Explosion Hall (Tiles #183, 184, 199, 200)
123. King's Hall (Tile #186)
124. Necromancer's laboratory (Tiles #214, 215)
125. Coffin storage (Tile #216)
126. Cages (Tile #217)
127. Dressing room (Tile #187)
128. Sacrificial Chamber (Tiles #173, 174, 188, 189)
129. Hall of Watching Thrones (Tiles #128, 143, 158)
130. Empty (Tile #202)
131. Witch Lair (Tiles #218, 219)

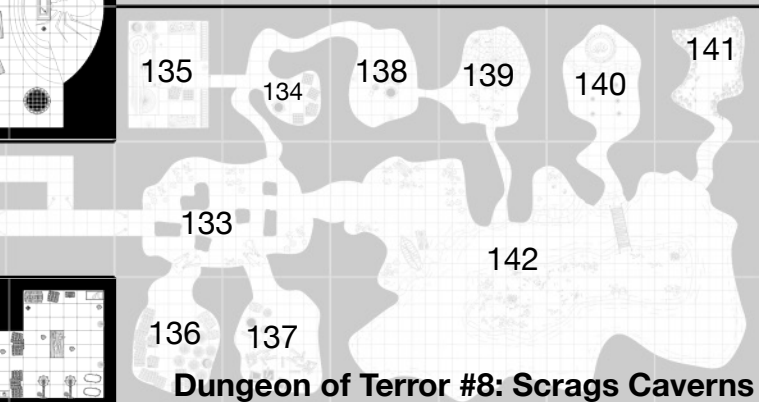
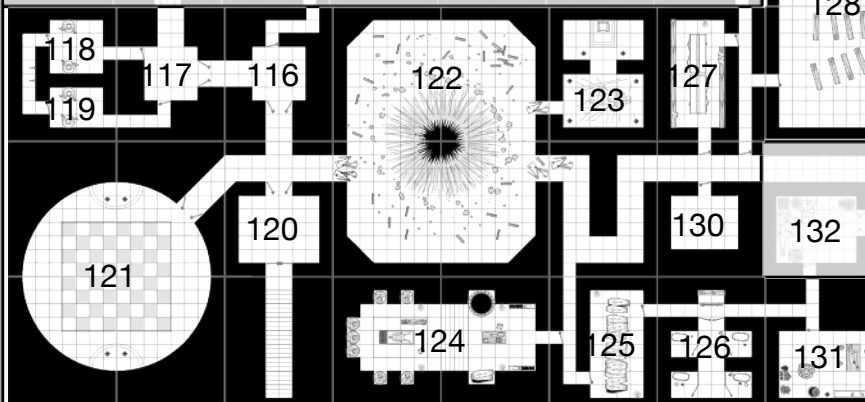
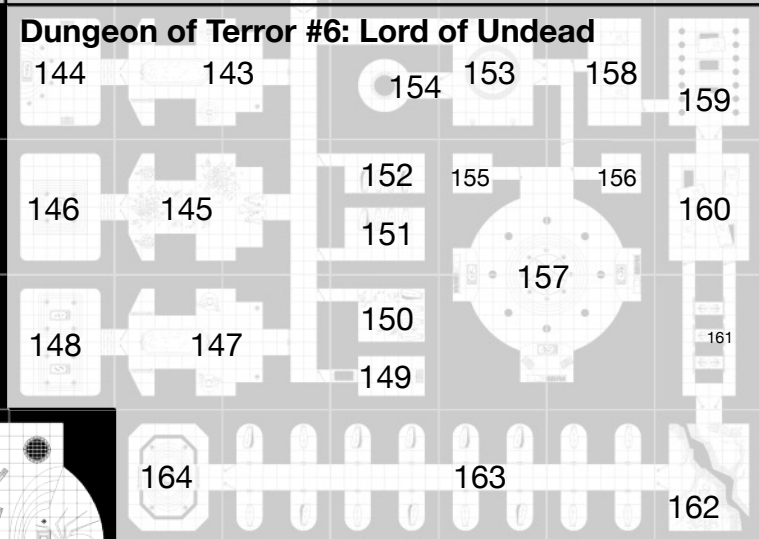
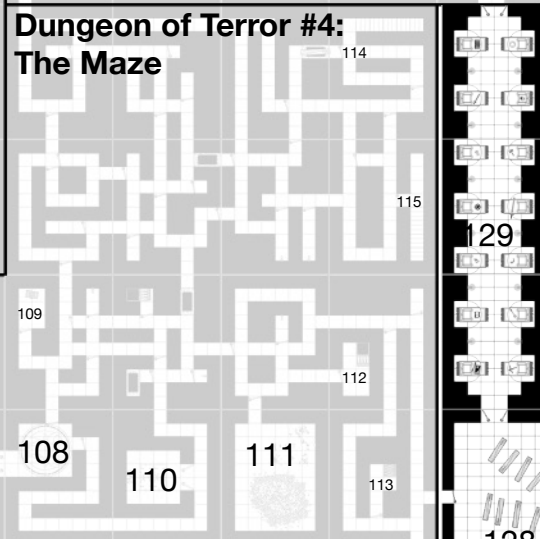
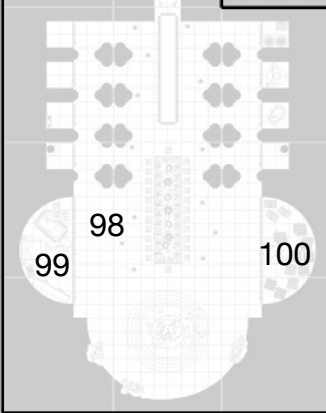
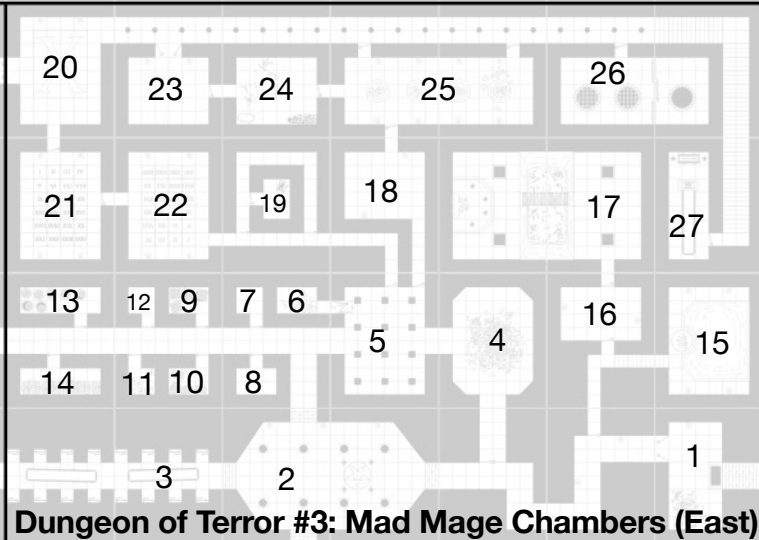
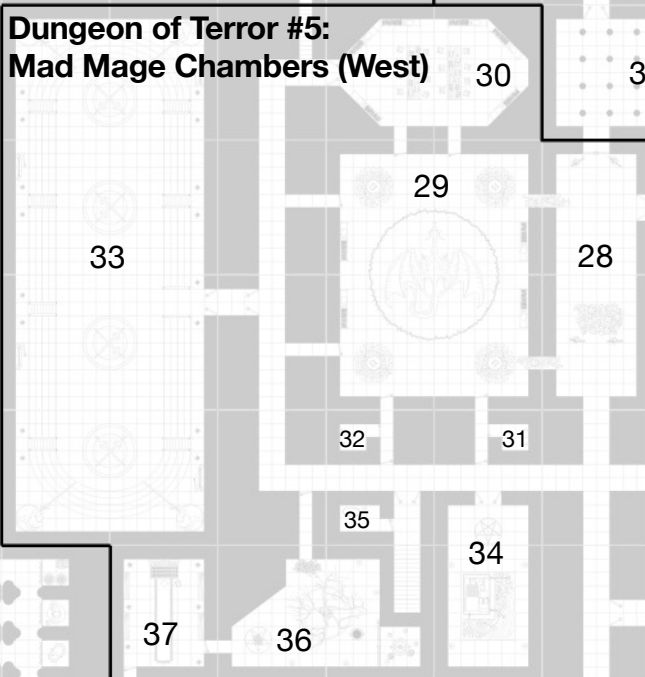
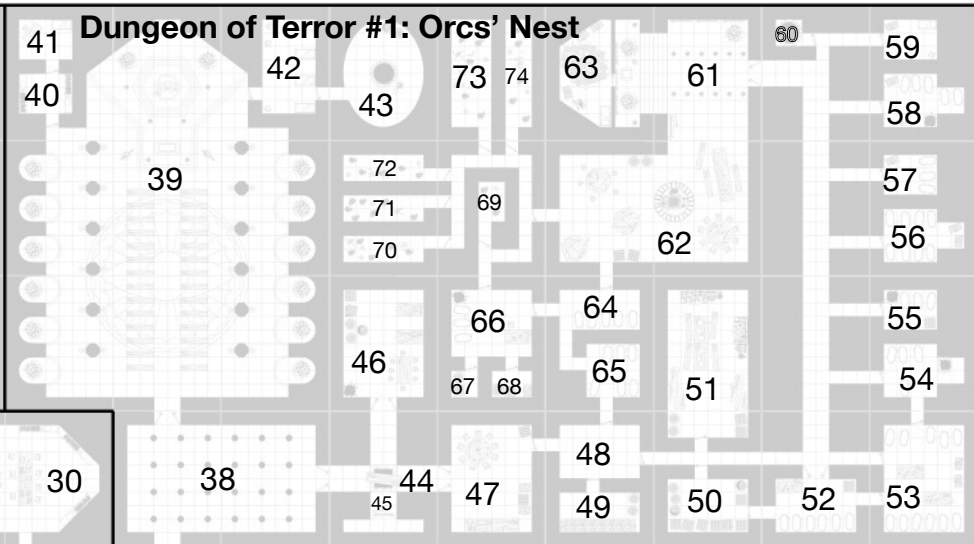
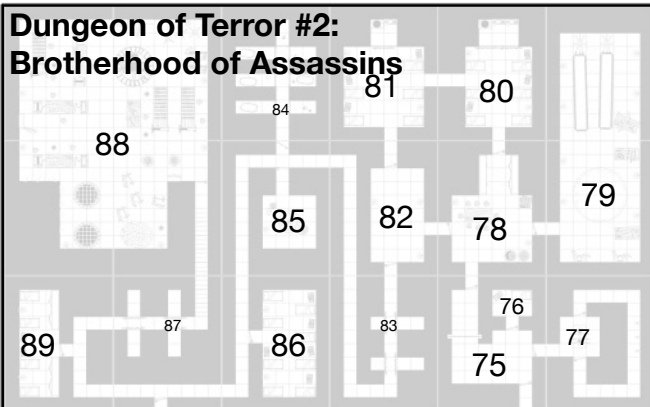

TERROR#128

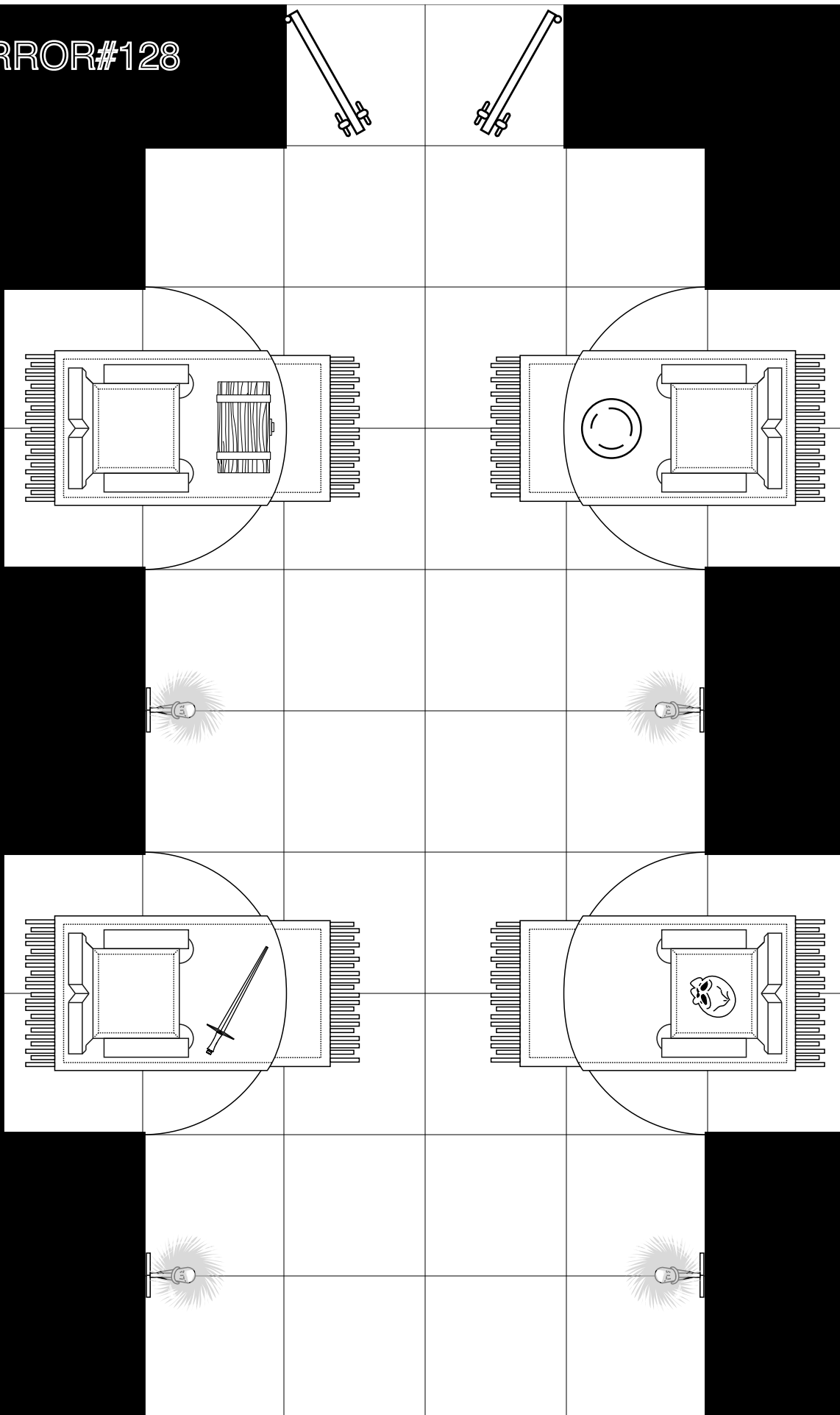

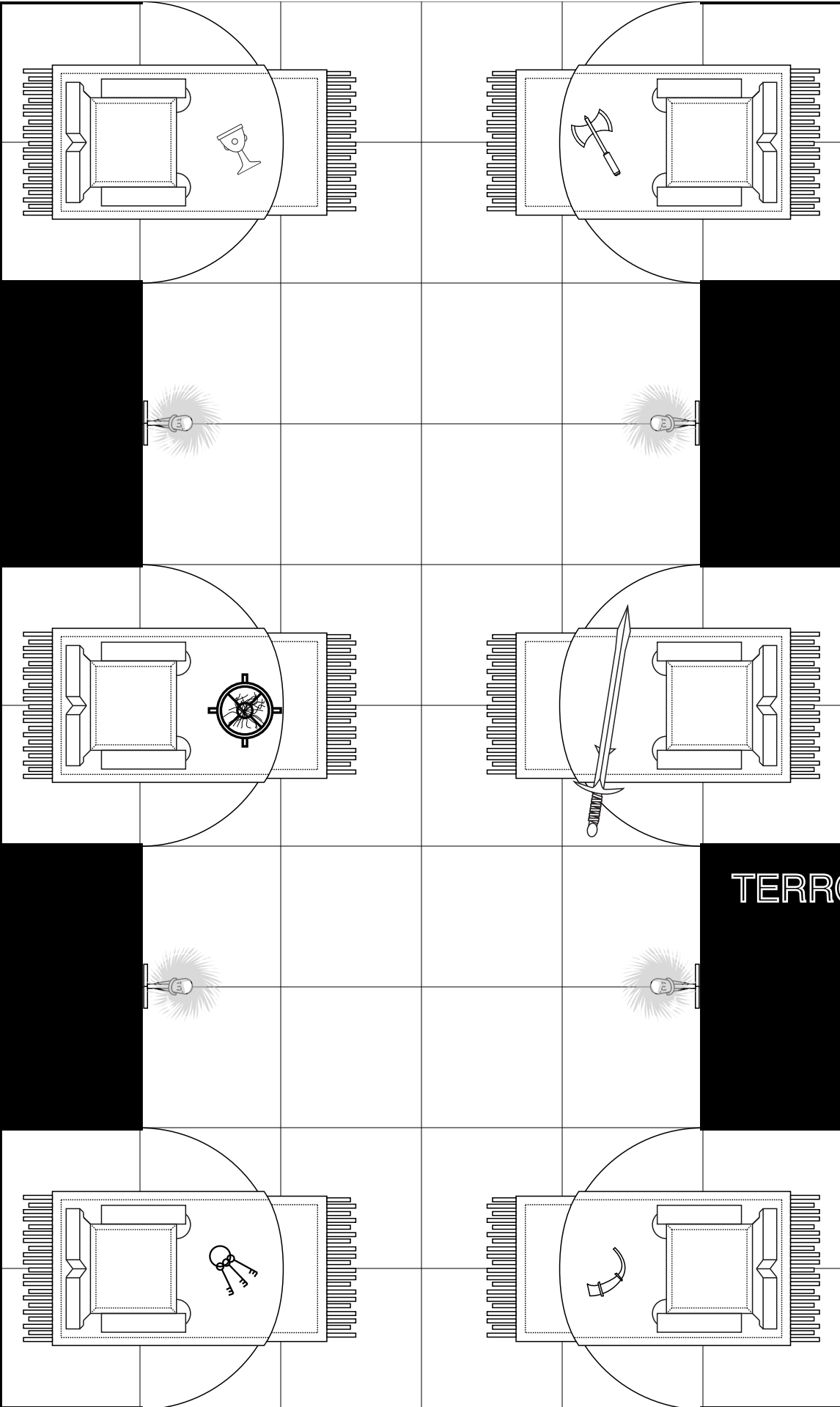

TERROR#143

TERROR#158

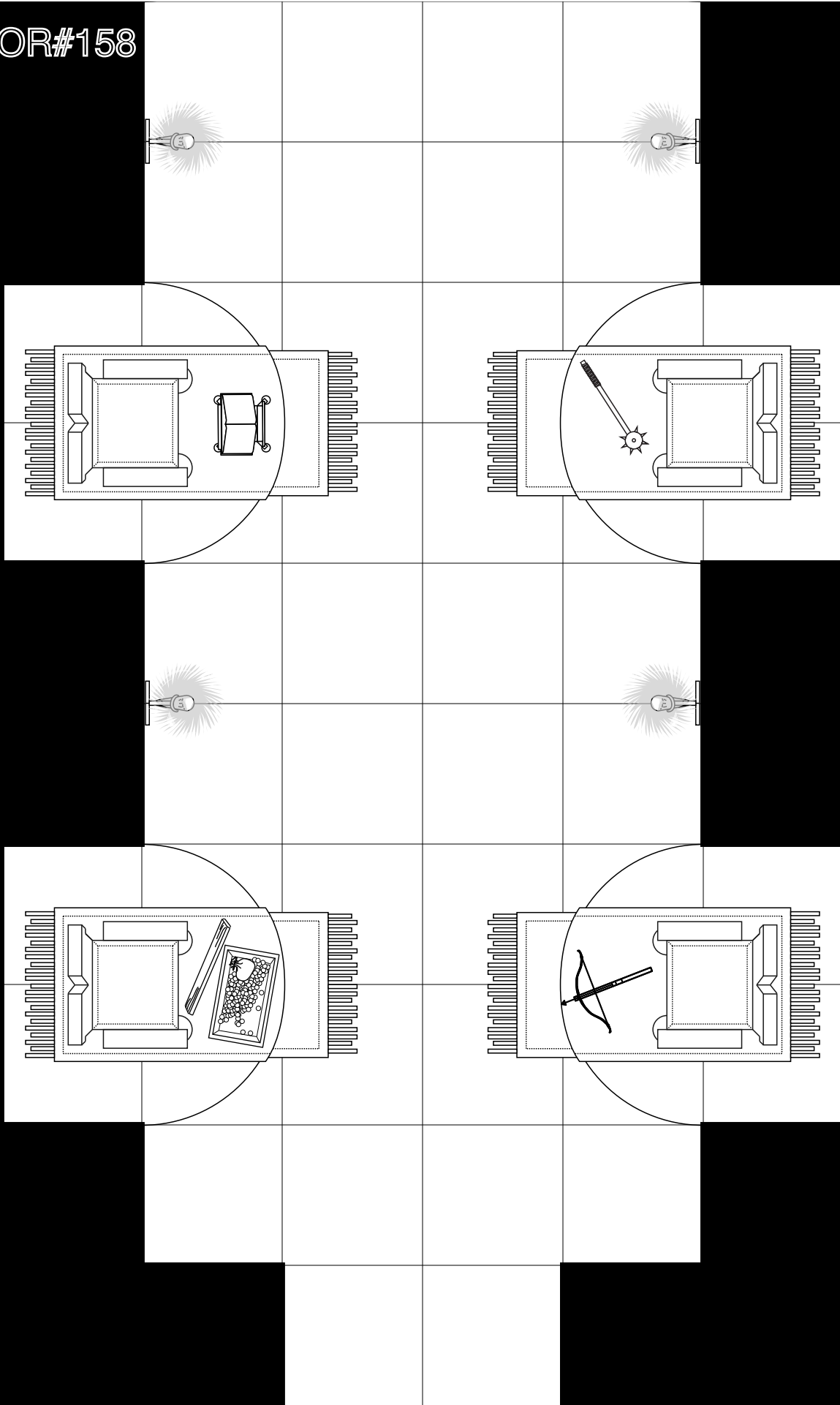

TERROR#173

© 2016 Games, permission granted to print for personal use only

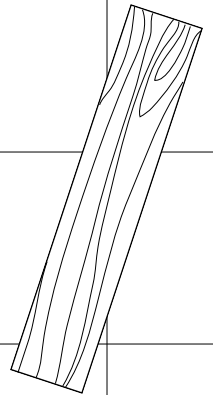
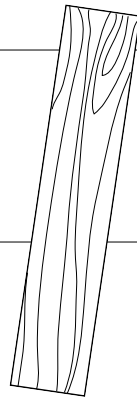
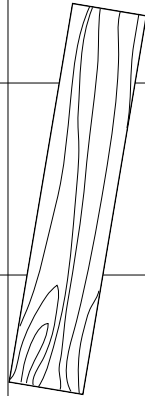
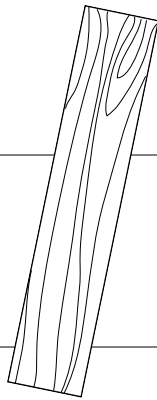
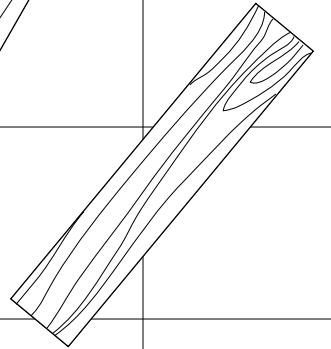
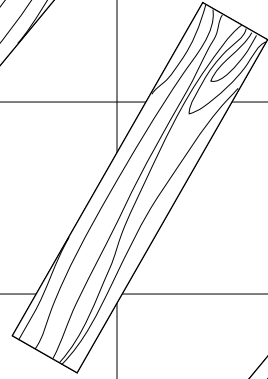
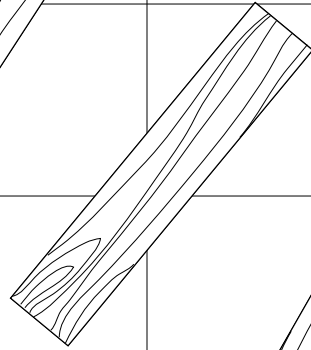
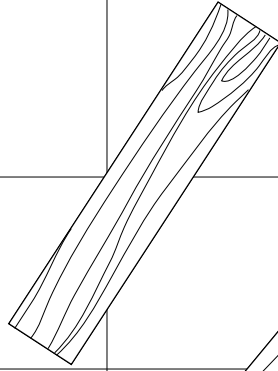
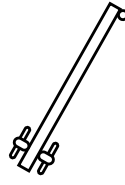
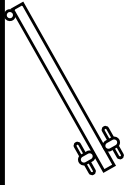

TERROR#174

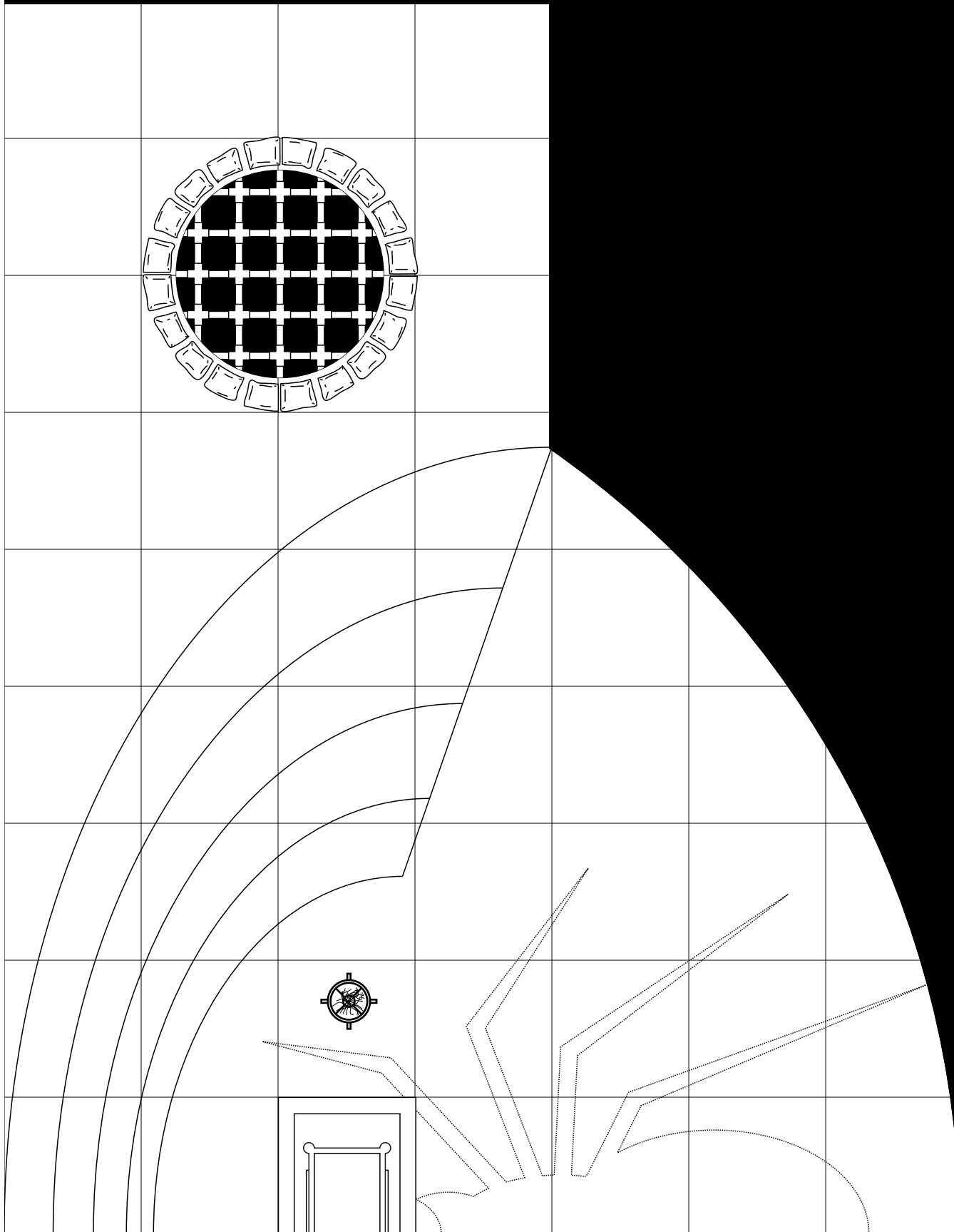

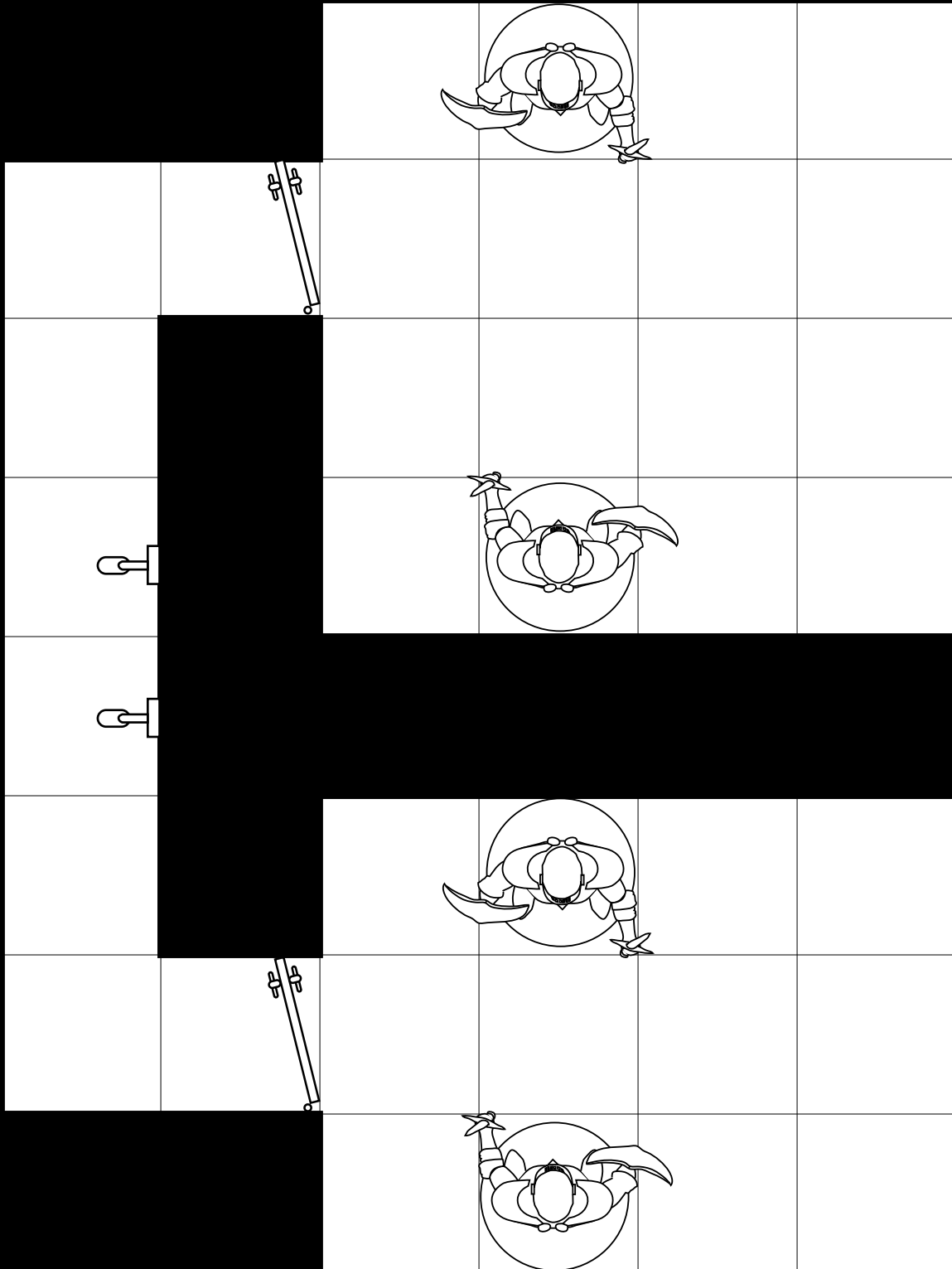

TERROR#181

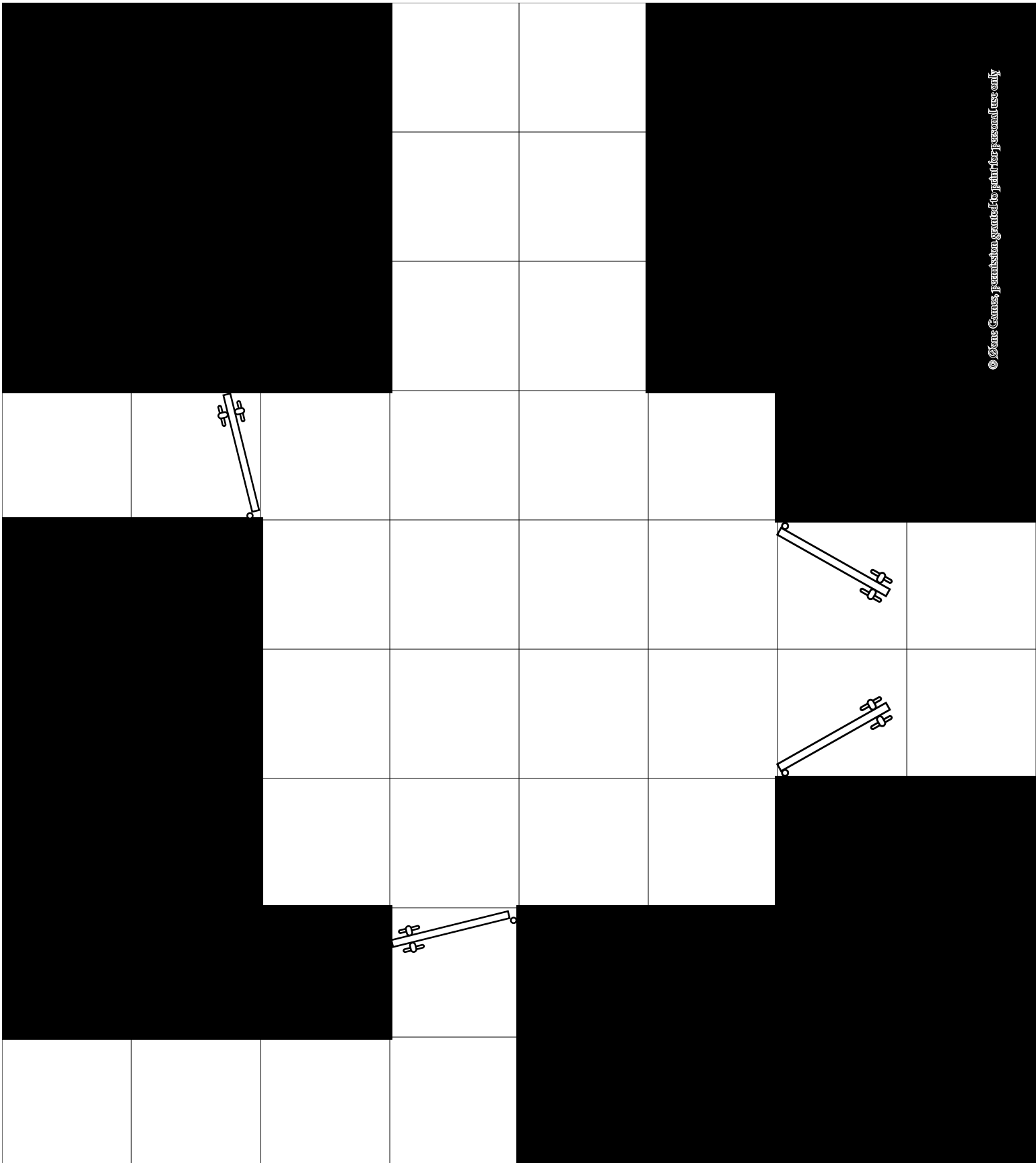

TERROR#182

TERROR#183

© Game Games, permission granted to print for personal use only

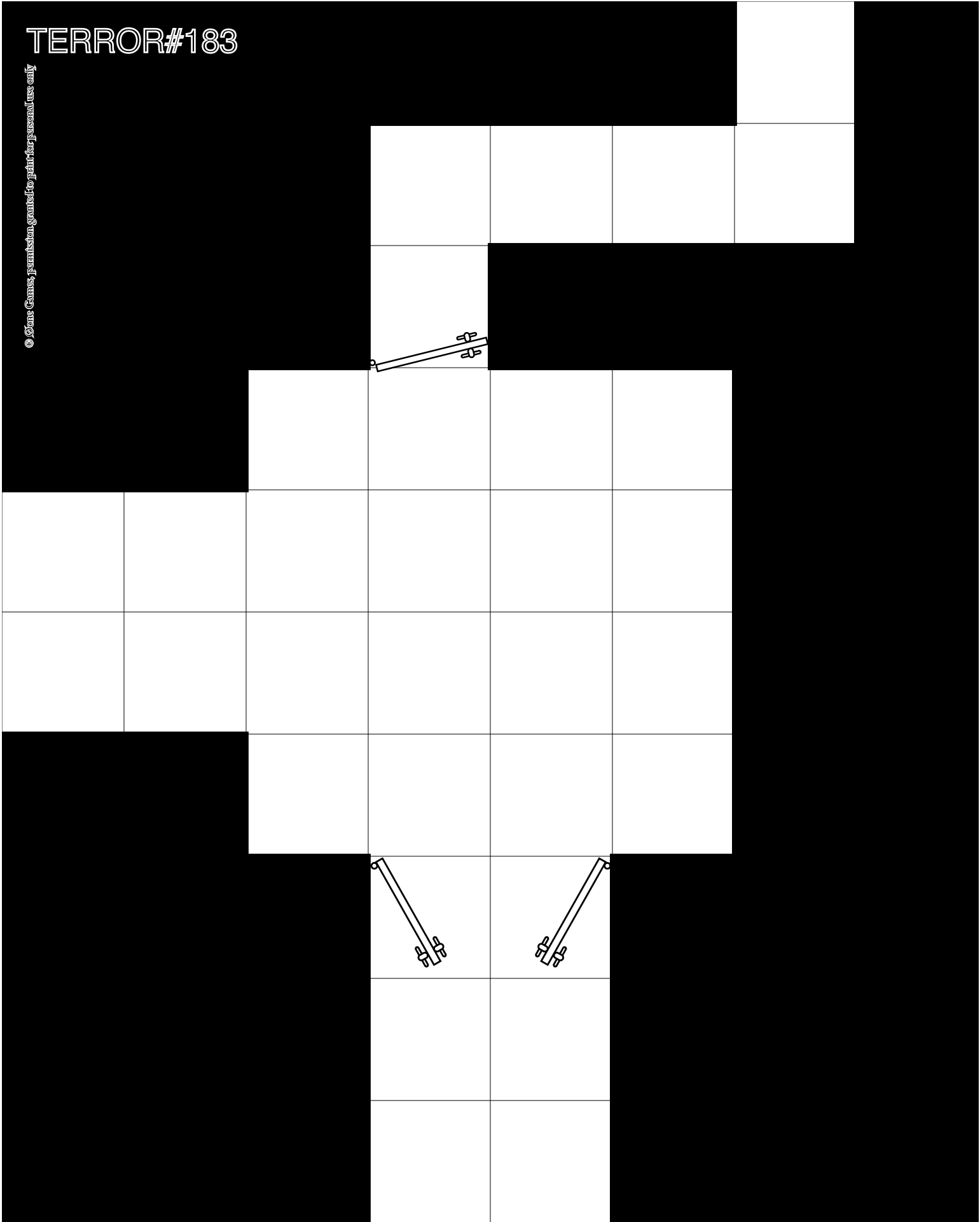

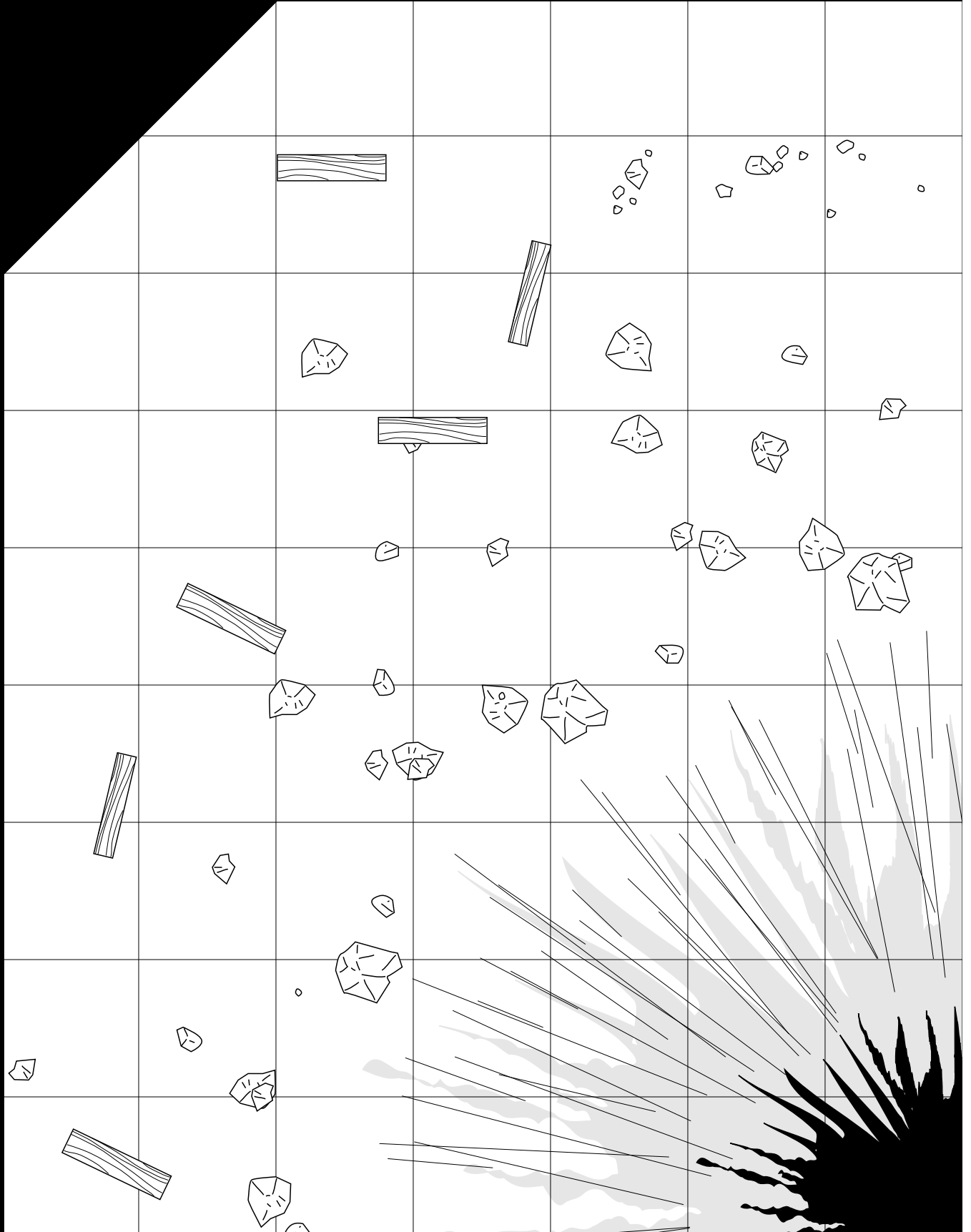

TERROR#185

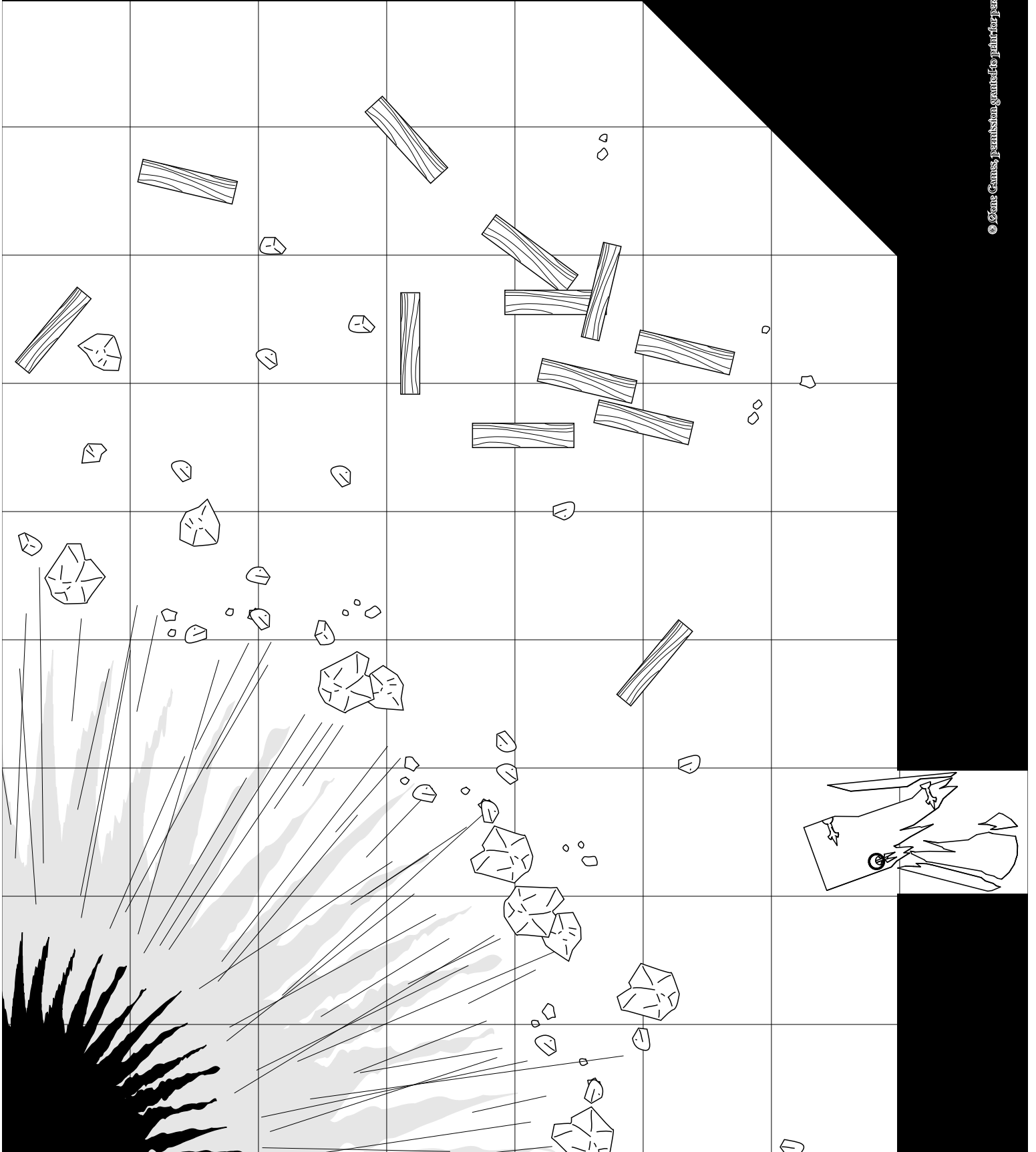

TERROR#186

© Game Games, permission granted to print for personal use only

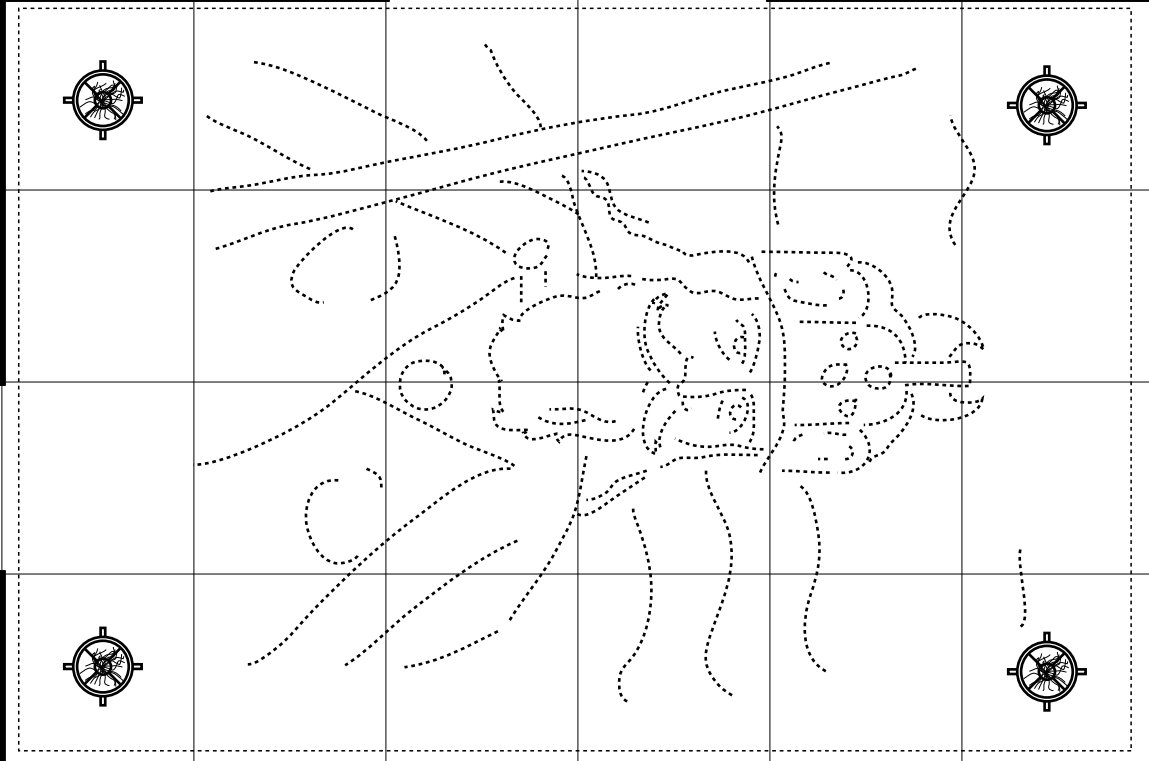
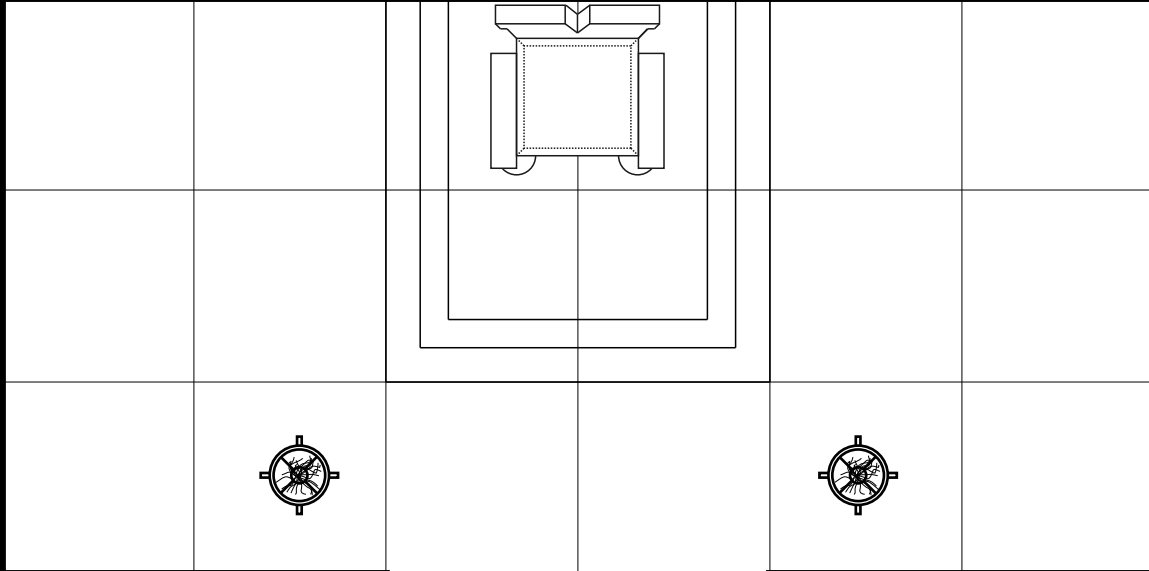

TERROR#187

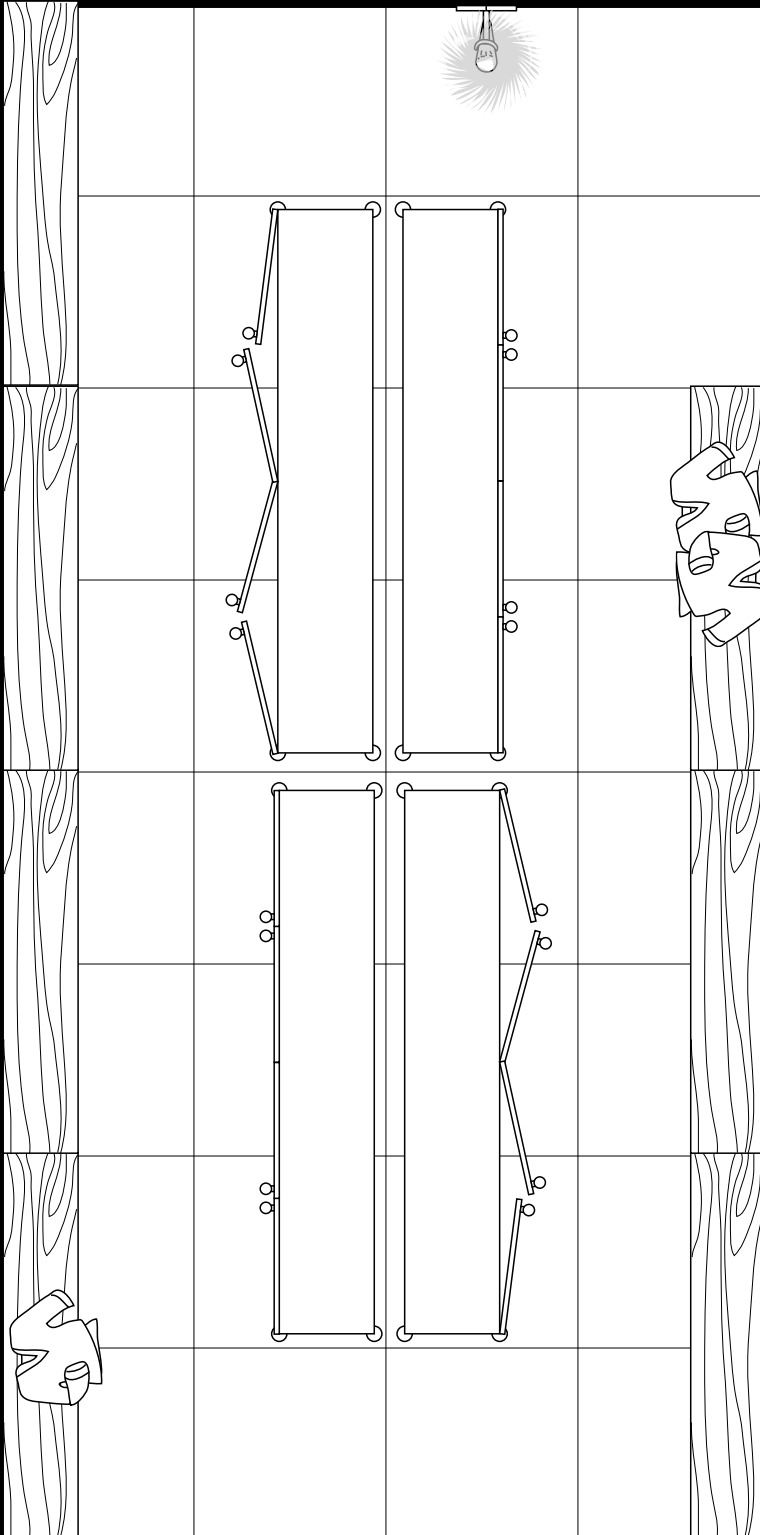

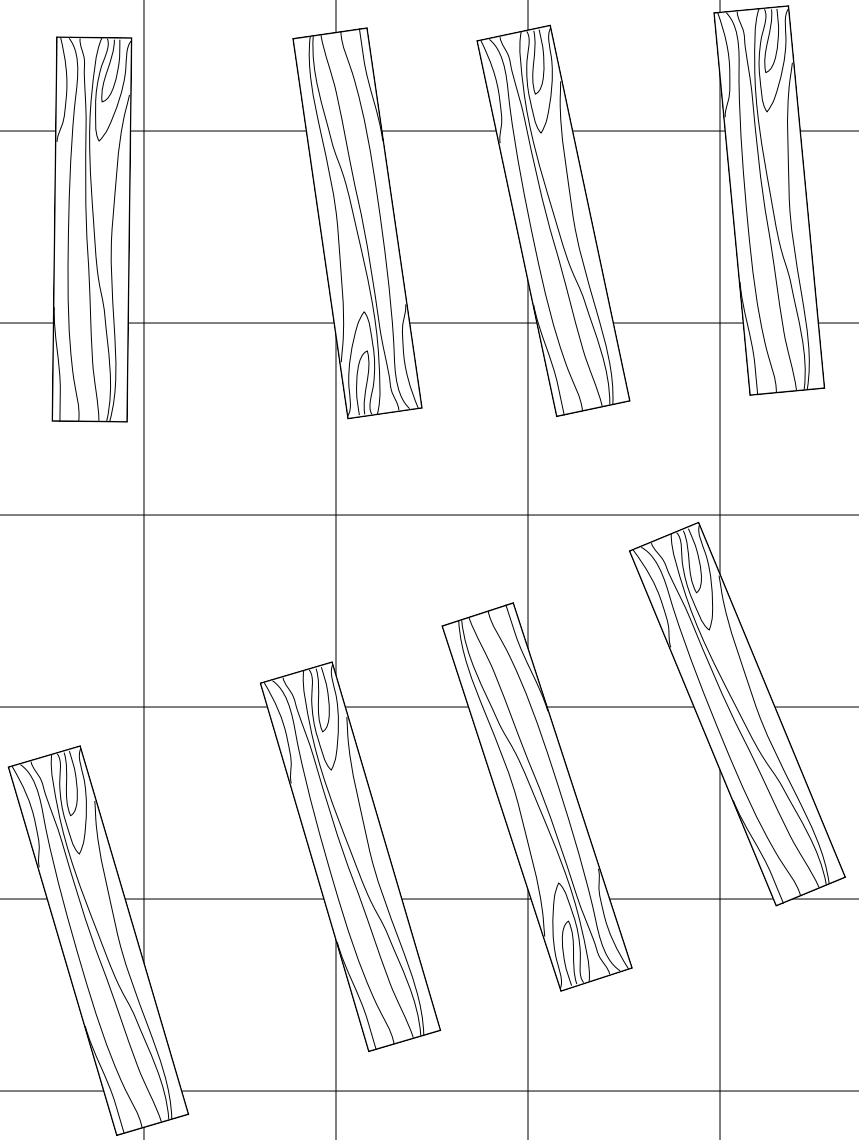

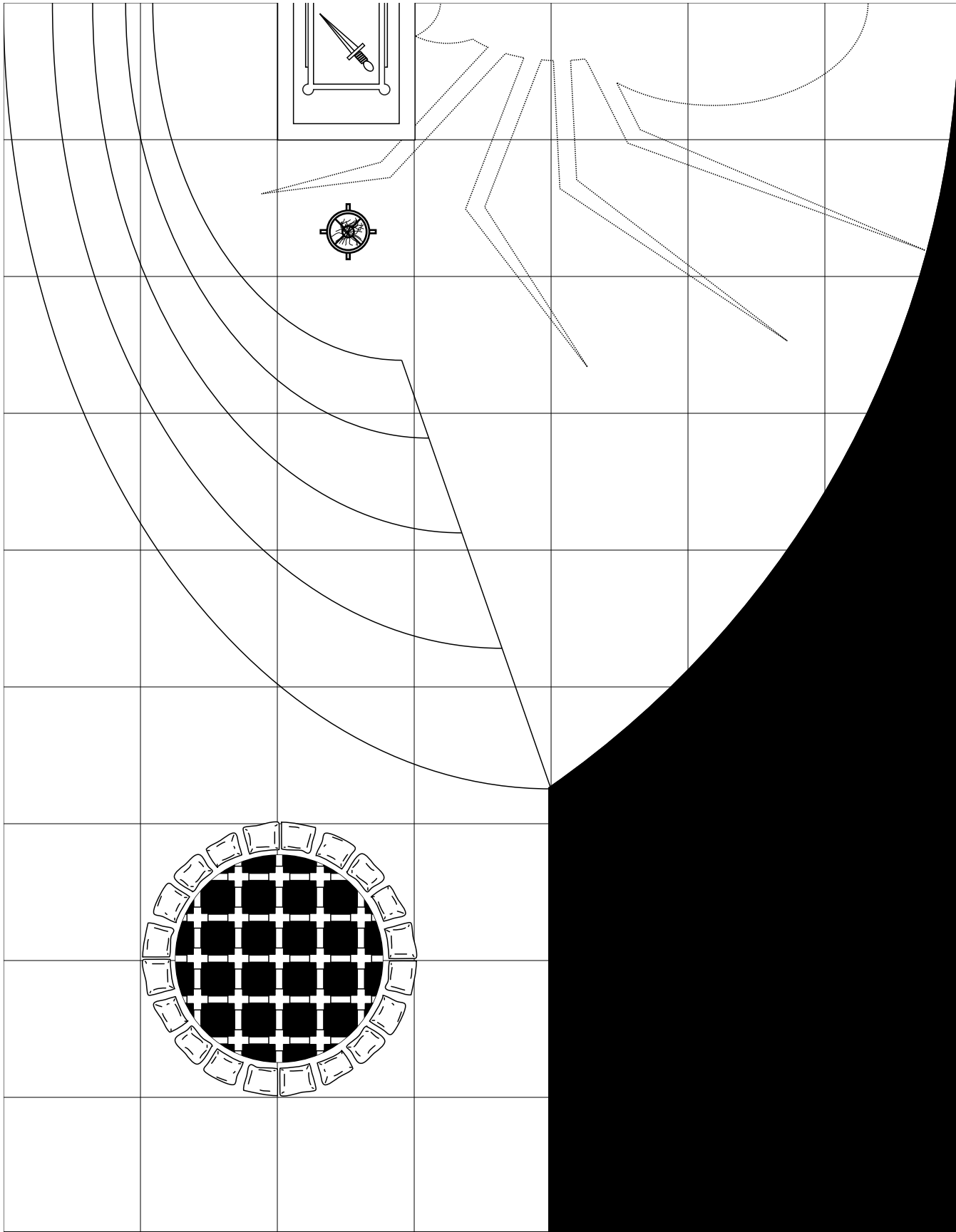

TERROR#196

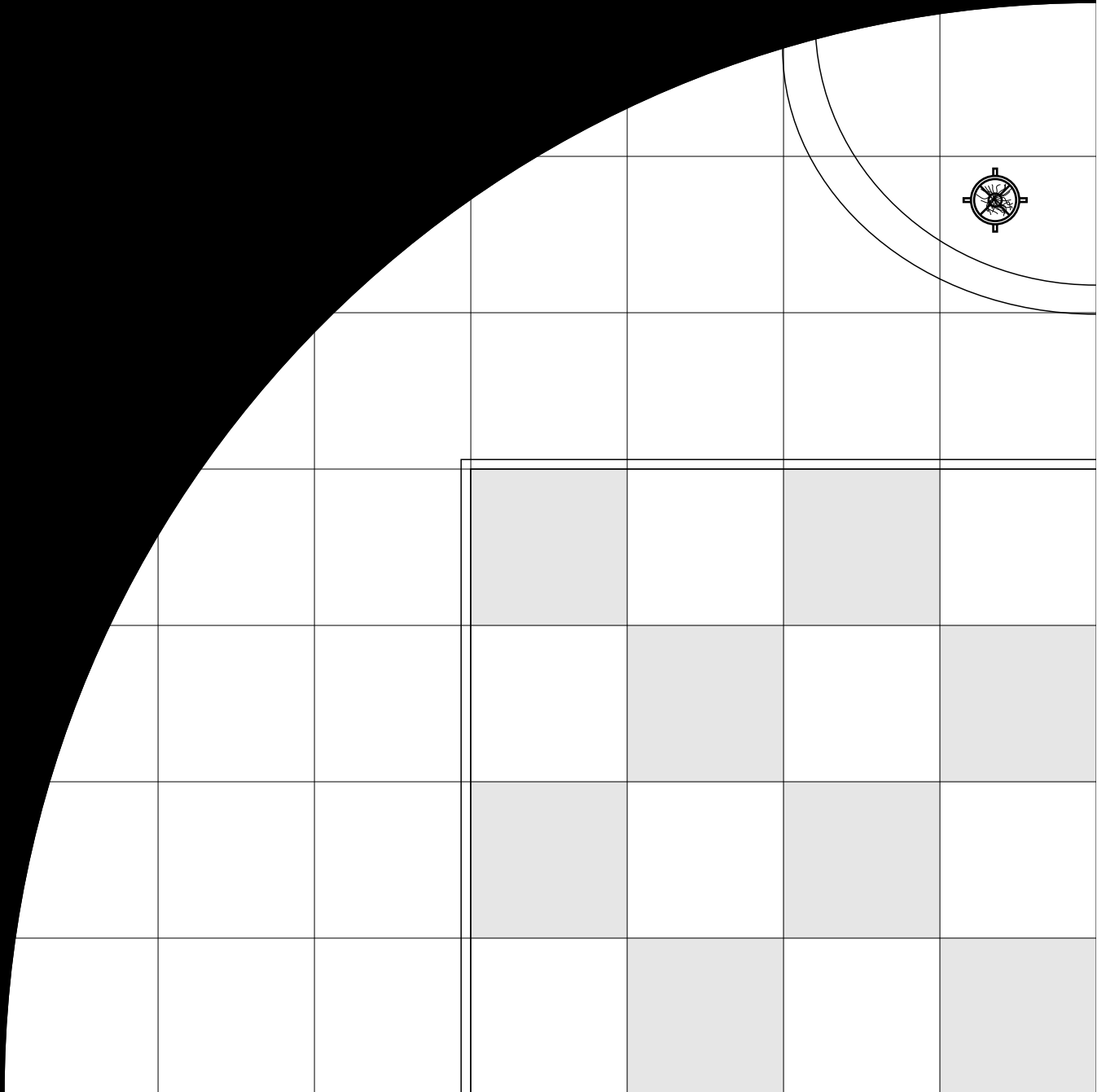

TERROR#197

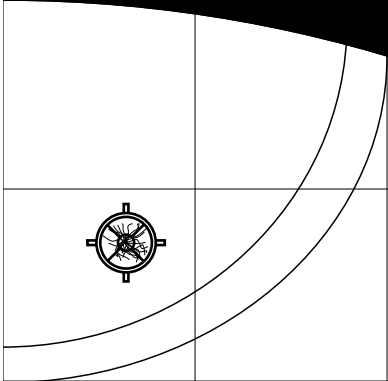

TERROR#198

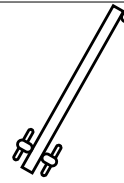
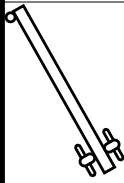

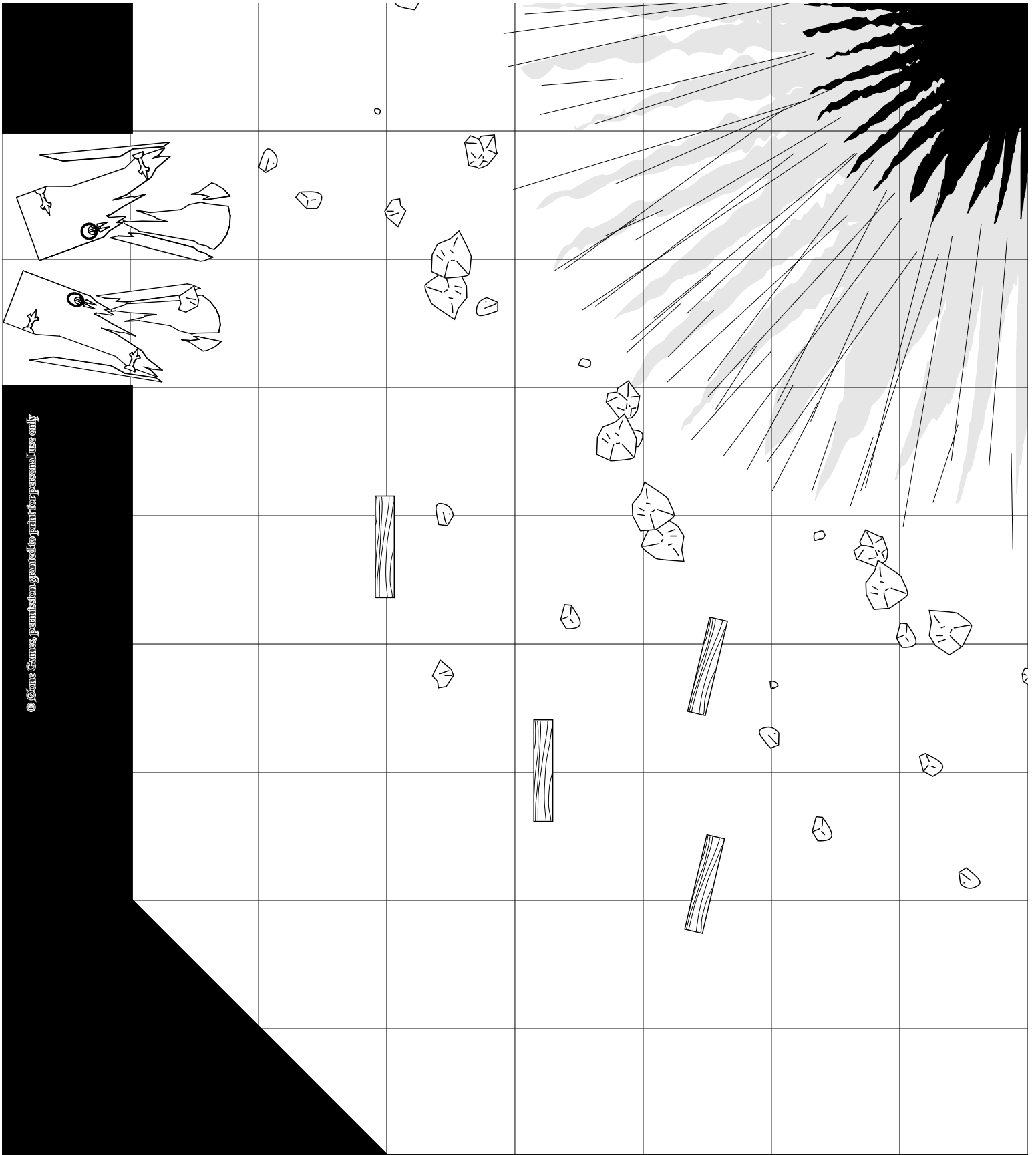

© 2015 Games, permission granted to print for personal use only

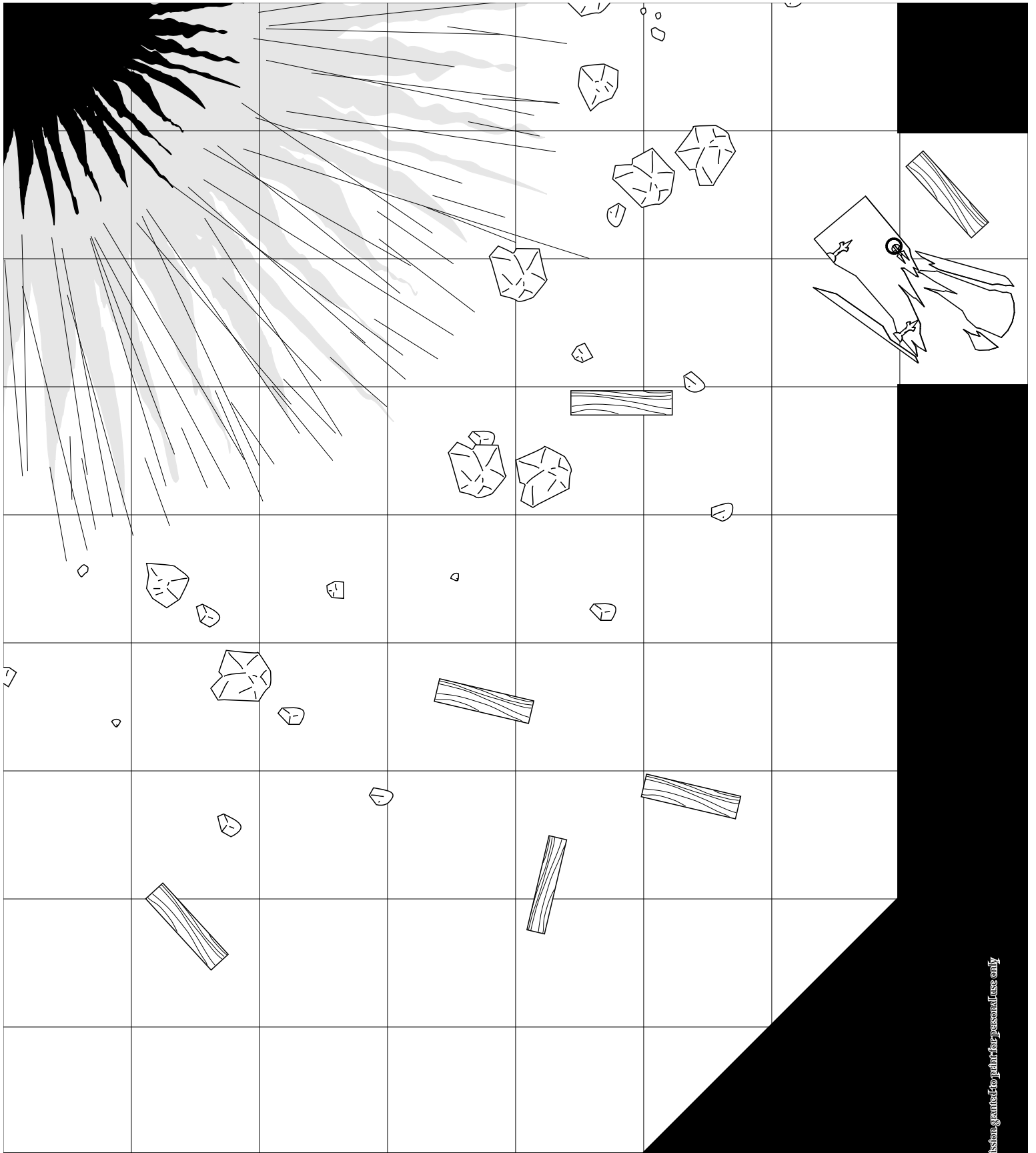

TERROR#200

TERROR#201

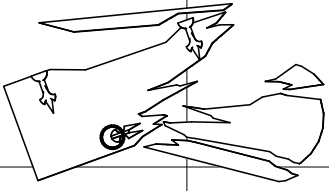

TERROR#202

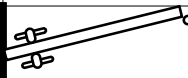
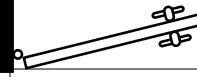
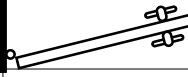

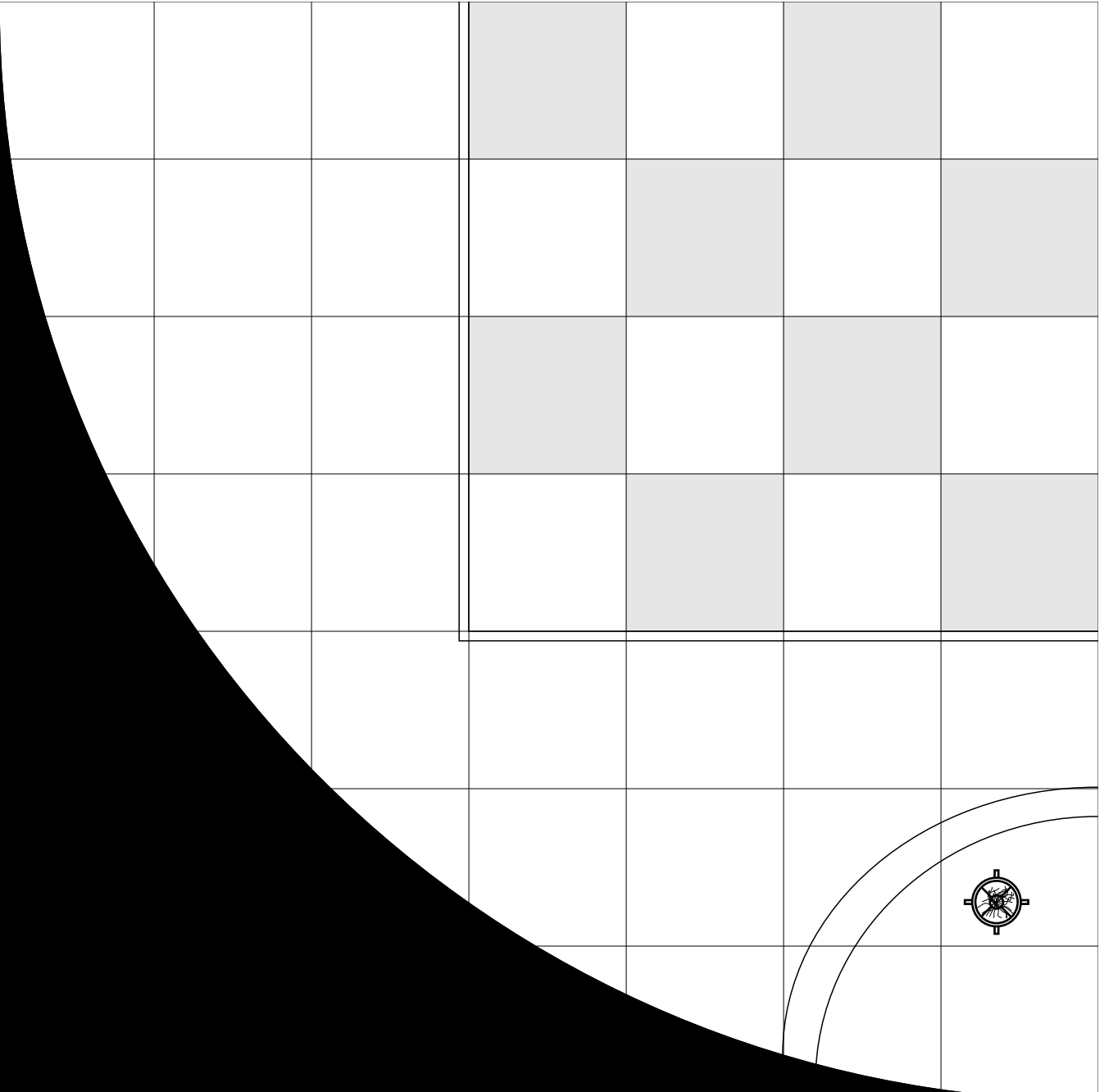

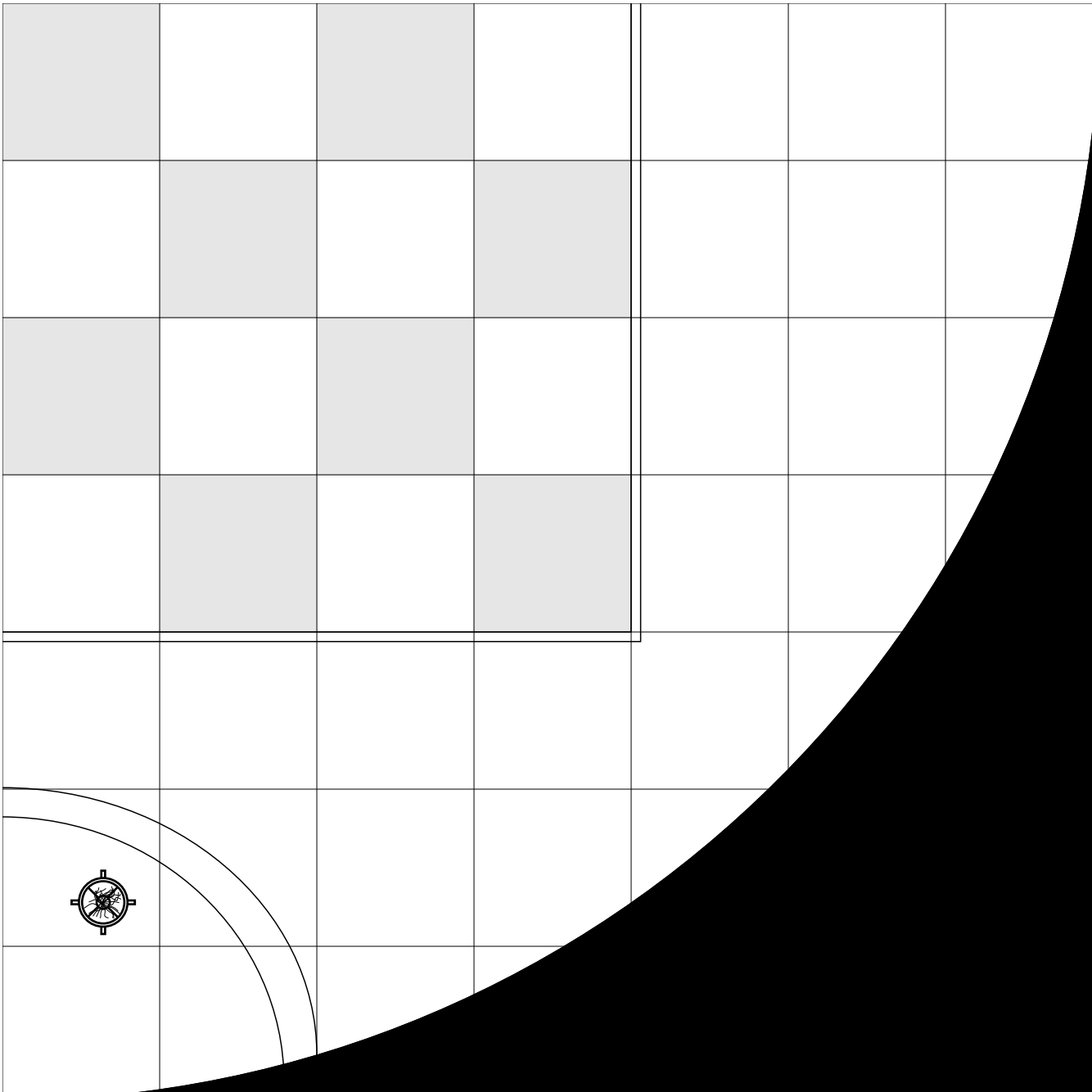

TERROR#212

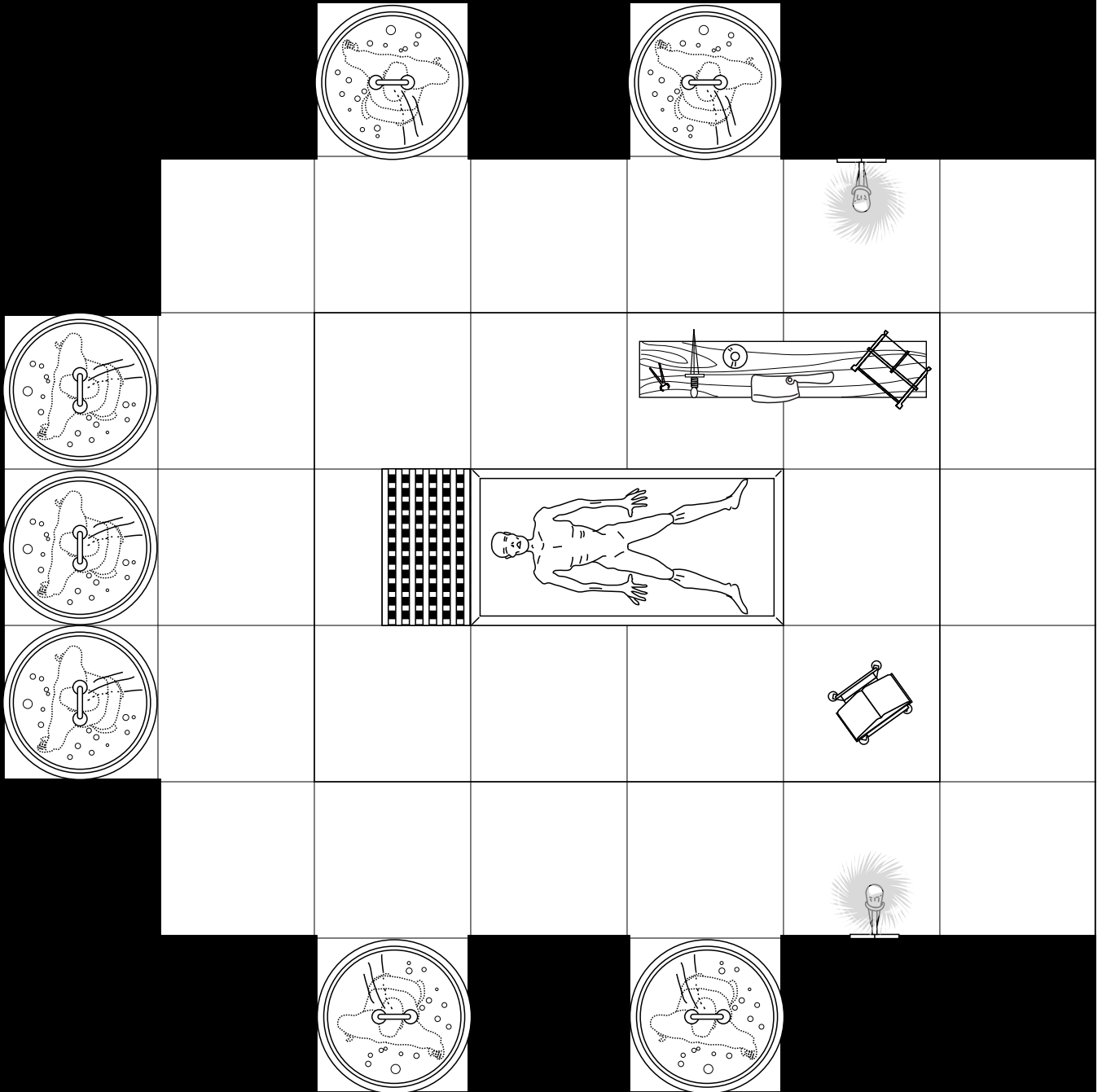

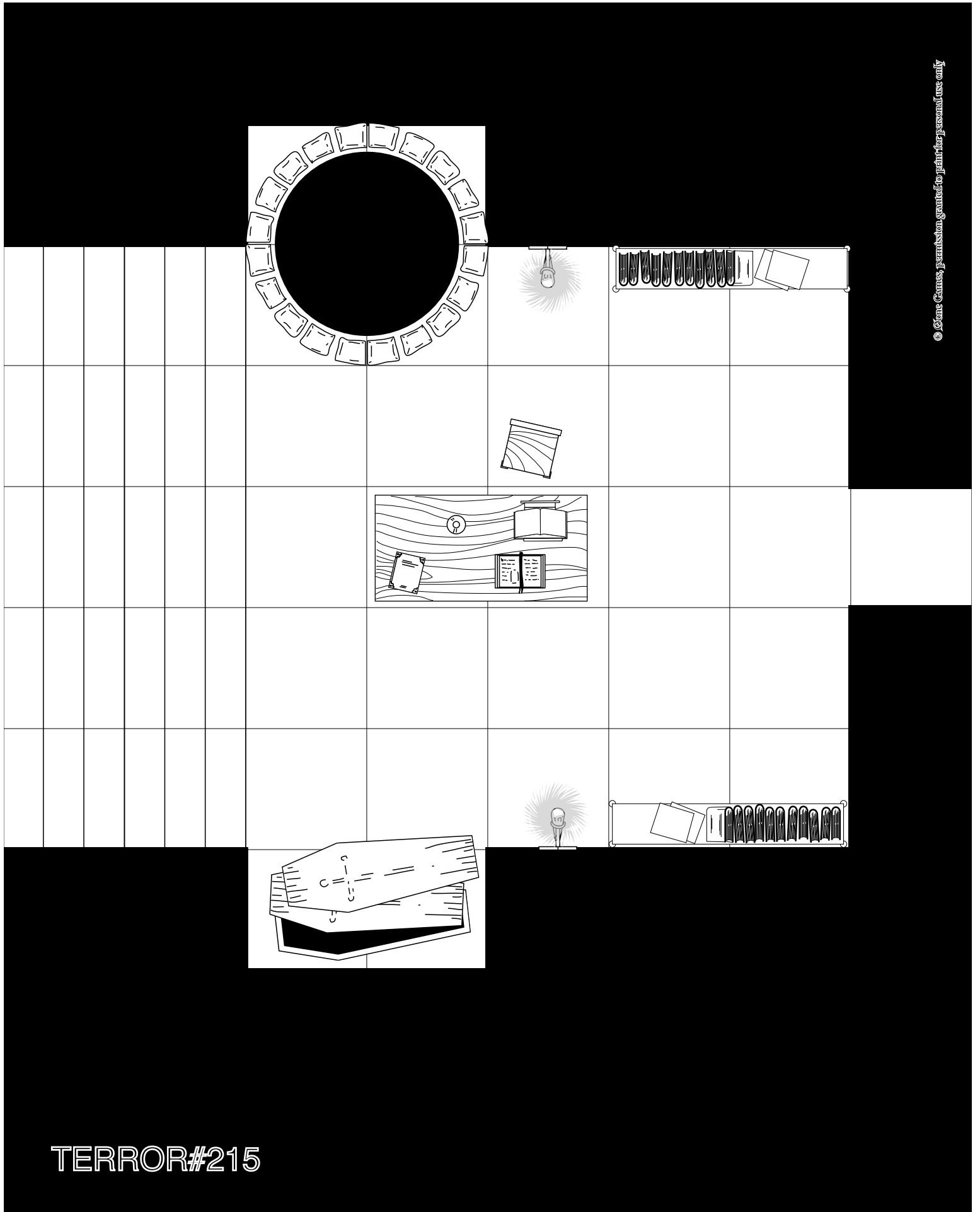

TERROR#215

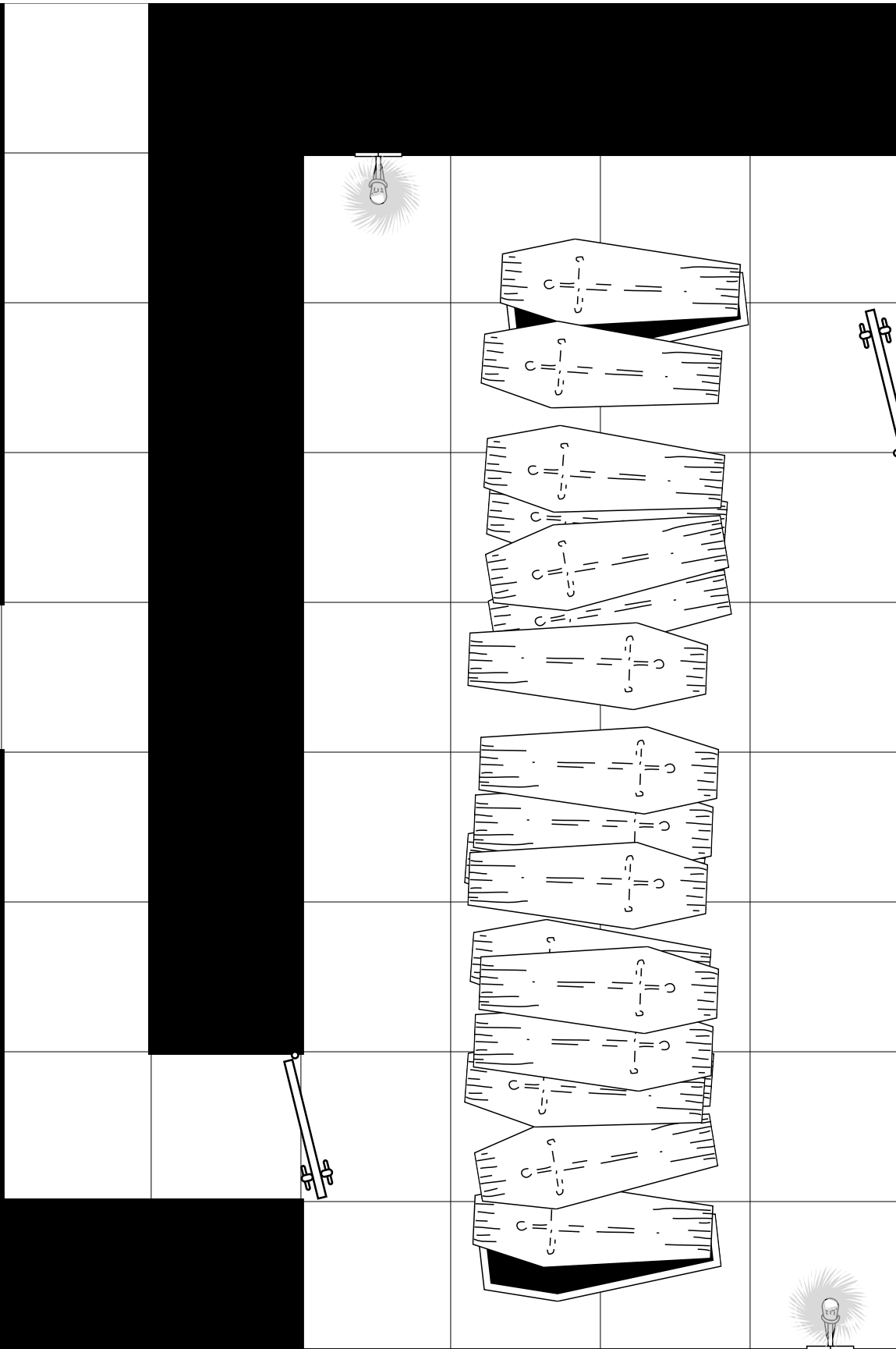

TERROR#217

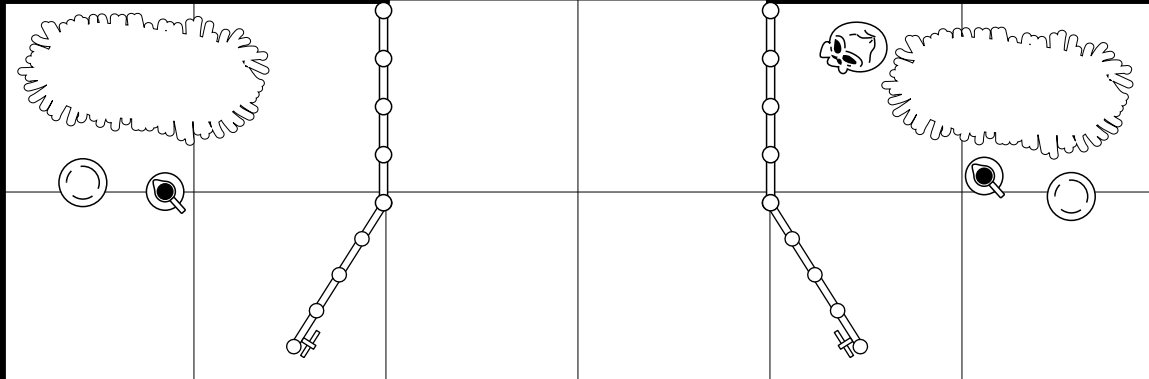
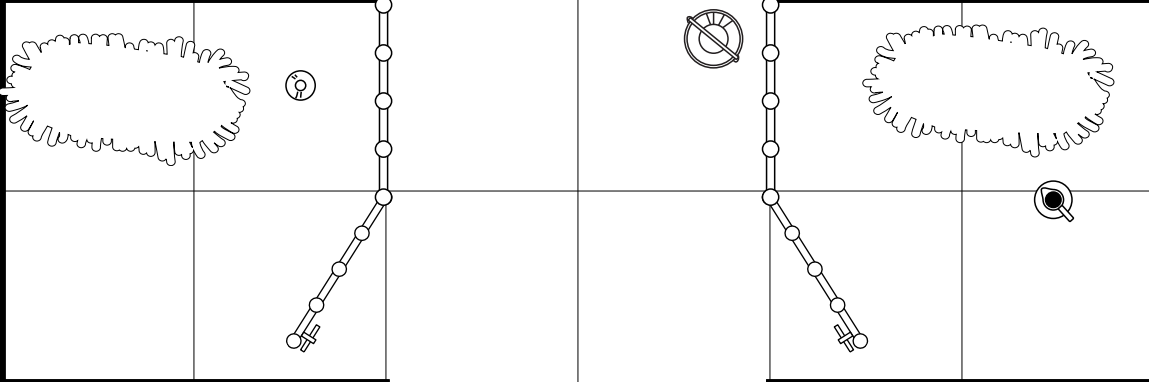
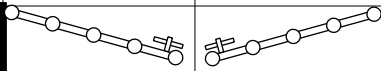
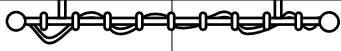
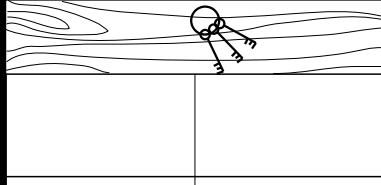

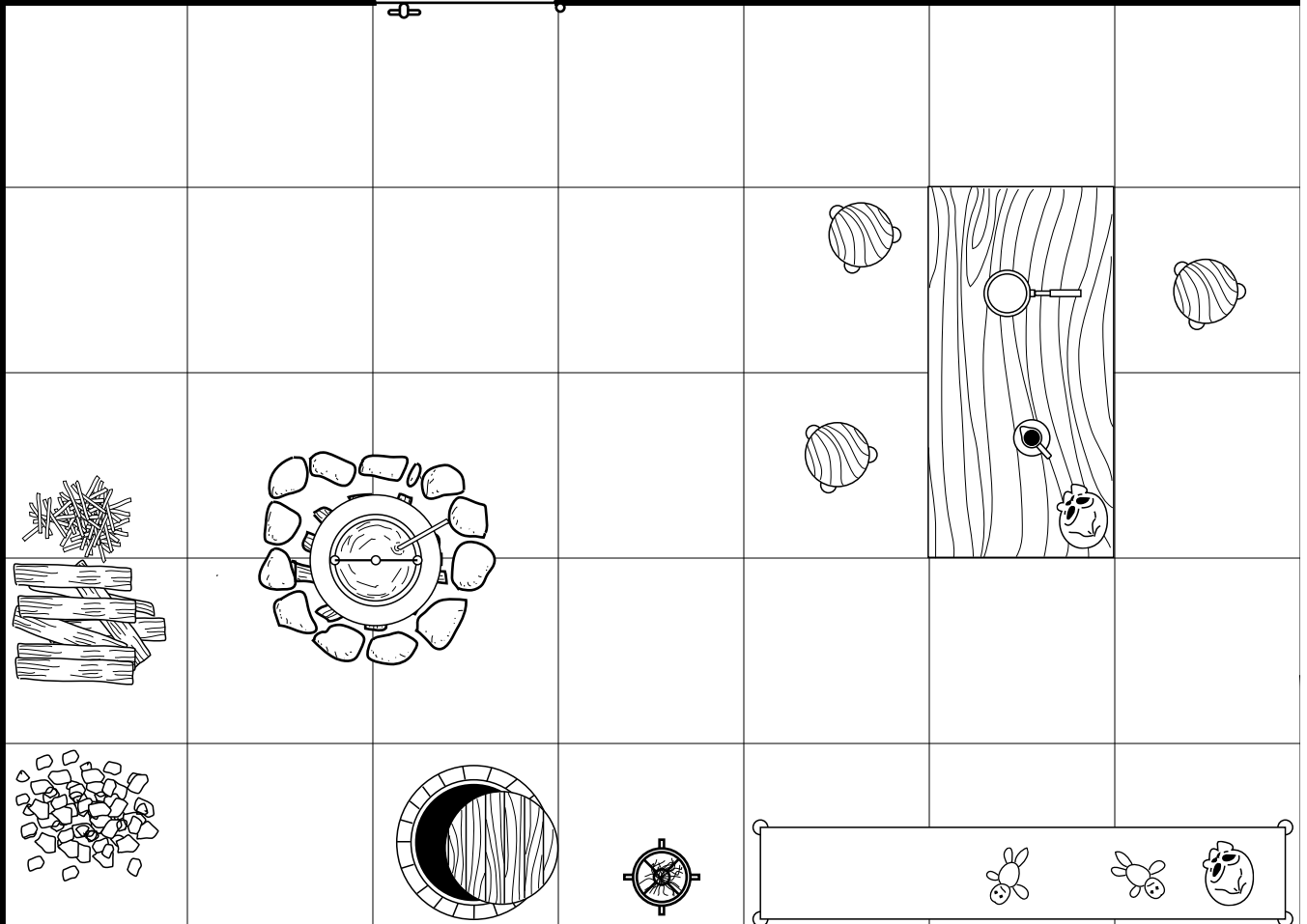

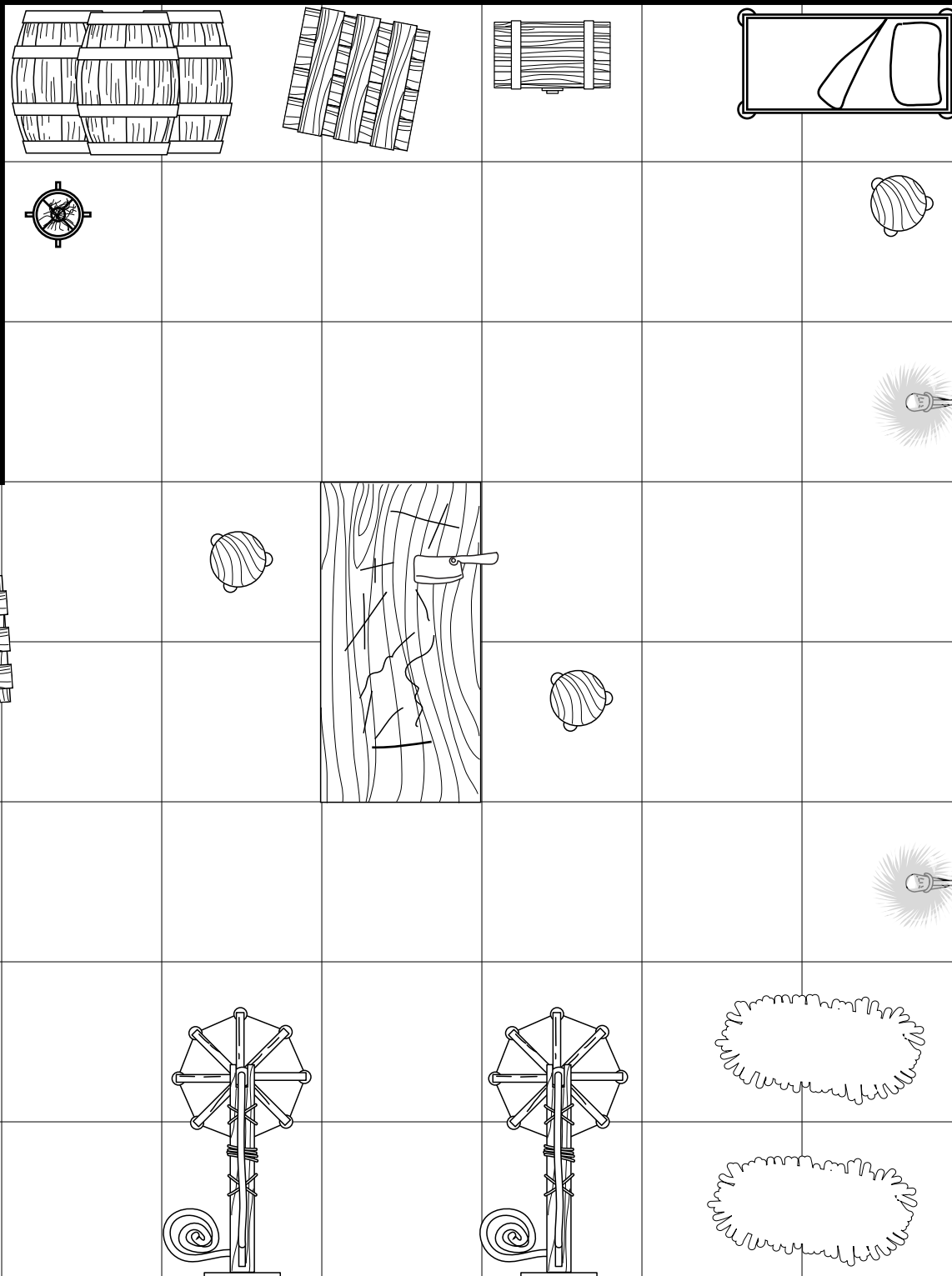

DUNGEON OF TERROR

THE LARGEST DUNGEON EVER TILED

• 225 TILES (8X10") • 164 ROOMS • 8 AREAS • TOTAL MEASURES 120X150"

MAY 09

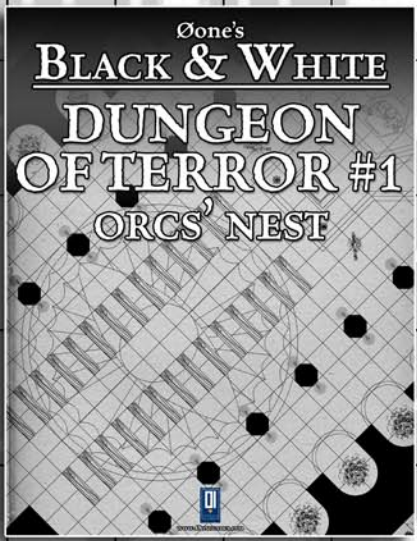

MAY 09

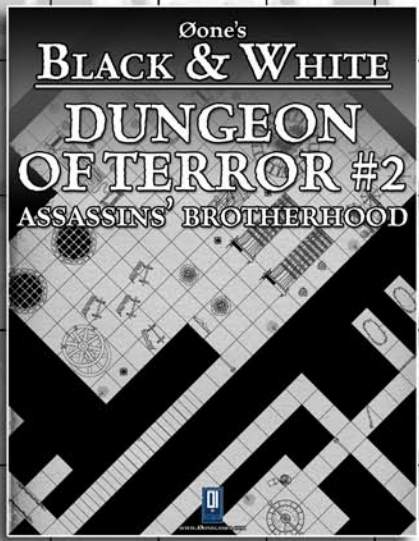

JUNE 09

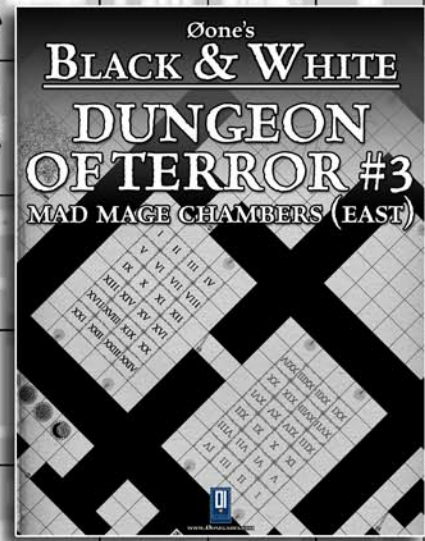

JUNE 09

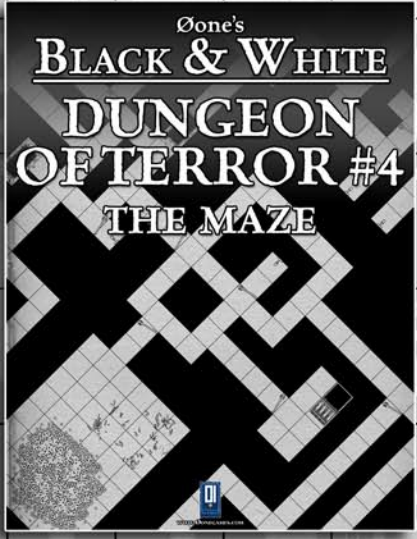

JUNE 09

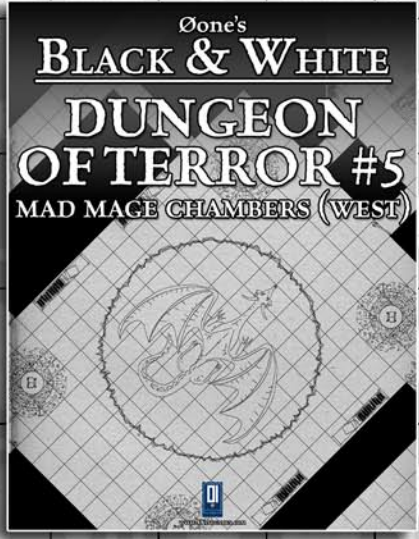

JULY 09

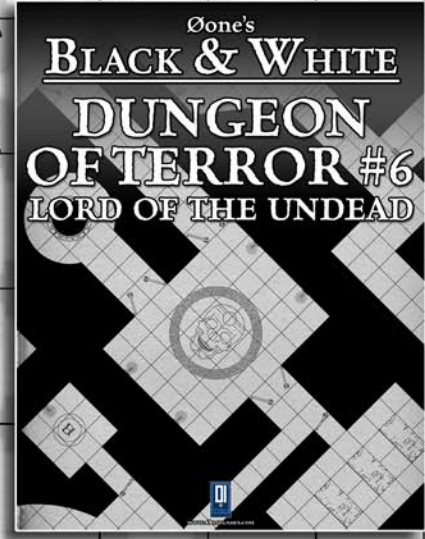

JULY 09

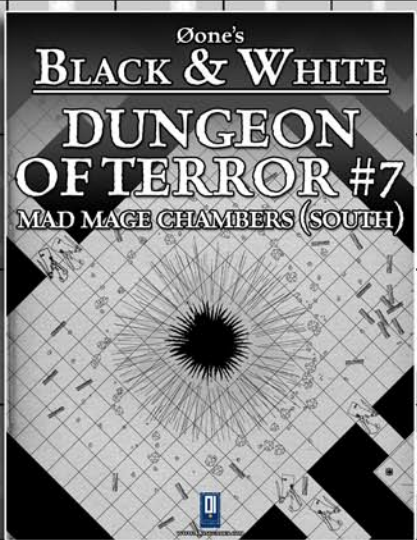

AUGUST 09

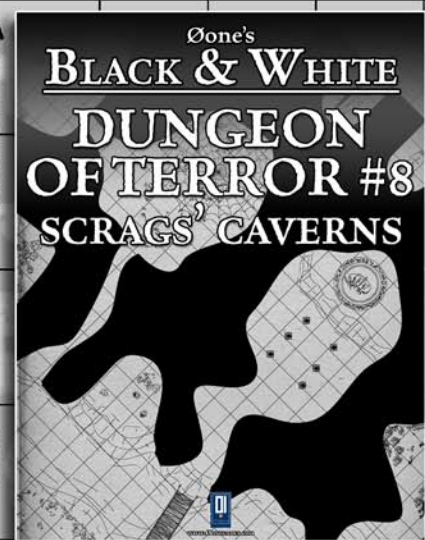

- **CUSTOMIZABLE**
- **DETAILED**
- **INEXPENSIVE**
- **NO INK-EATING**

ØONE GAMES

the first d20 pdf publisher of the world

www.Øonegames.com