

# ONLY WAR™

## SHIELD OF HUMANITY



THE SUPPORT SPECIALIST'S  
HANDBOOK

WARHAMMER  
40,000  
ROLEPLAY

# ONLY WAR™



ROLEPLAYING IN THE GRIM DARKNESS  
OF THE 4<sup>TH</sup> MILLENNIUM

# CREDITS

## LEAD DEVELOPER

Tim Flanders

## WRITING AND DEVELOPMENT

Owen Barnes, Max Brooke, Kendal Butner, Tim Cox, Matt Eustace, Jordan Goldfarb, and Ross Watson

## EDITING AND PROOFREADING

Mark Latham

## MANAGING RPG PRODUCER

Chris Gerber

## GRAPHIC DESIGN

Evan Simonet and Edge Studios

## GRAPHIC DESIGN MANAGER

Brian Schomburg

## COVER ART

Imaginary FS Pte Ltd

## INTERIOR ART

Dmitri Bielak, John Blanche, Mauro Dal Bo, Alberto Bontempi, Alex Boyd, Jon Cave, Kevin Chin, Paul Dainton, Vincent Devault, Dave Gallagher, Jes Goodwin, David Griffith, Ilich Henriquez, Nikolaus Ingeniri, Jason Juta, Sam Lamont, Mark Molnar, Ameen Naksewee, David Auden Nash, Aaron Riley, Mark W. Smith

## MANAGING ART DIRECTOR

Andrew Navaro

## ART DIRECTION

John Taillon

## PRODUCTION MANAGEMENT

Eric Knight

## LICENSING & DEVELOPMENT COORDINATOR

Deb Freytag & Amanda Greenhart

## EXECUTIVE GAME DESIGNER

Corey Konieczka

## EXECUTIVE PRODUCER

Michael Hurley

## PUBLISHER

Christian T. Petersen

## SPECIAL THANKS

Playtest Coordinator Zach Tewalthomas. "The 158th Cincinnatus Regiment" Trevor Stamper with William Johnson, Louis Barrera, and John Olszewski; Kris Miller with Chris Palmer and Phil Tracy; "Unrepentant" Lachlan "Raith" Conley with Jordan Dixon, Rhys Fisher, Nicole Gillies, and Aaron Wong; Benjamin Symons with Jo Pirard, Sander Reynders, Rafaél Dera; Karl Kristian Larsson; Ciaran O'Sullivan with Alex Porter, Nathan Neeson, Max Davidson, Jack Baptie, Corey Hayes; Sven Reuter with Olaf Bressel, Sascha Herzer, Andrea Kunz, Christian Kunz

## GAMES WORKSHOP

### LICENSING MANAGER

John French and Graham Nicoll

### HEAD OF LICENSING

Jon Gillard

### HEAD OF LICENSING, LEGAL, AND STRATEGIC PROJECTS

Andy Jones

### HEAD OF INTELLECTUAL PROPERTY

Alan Merrett



Ulisses North America, LLC  
8225 Sedona Sunset Drive  
Las Vegas  
NV 89128

Warhammer 40,000: Shield of Humanity © Copyright Games Workshop Limited 2017. Only War, the Only War logo, GW, Games Workshop, Space Marine, 40k, Warhammer, Warhammer 40,000, 40,000, the 'Aquila' Double-headed Eagle logo, and all associated logos, illustrations, images, names, creatures, races, vehicles, locations, weapons, characters, and the distinctive likenesses thereof, are either ® or TM, and/or © Games Workshop Limited, variably registered around the world, and used under licence. Ulisses Spiele, Ulisses North America, and their logos are trademarks of Ulisses Spiele. All rights reserved to their respective owners.

For more information about the **ONLY WAR** line, free downloads, answers to rule queries, or just to pass on greetings, visit us online at

[www.ulissesnorthamerica.com](http://www.ulissesnorthamerica.com)

# CONTENTS

## Introduction

What's in this Book? .....	4
Auxiliary Forces in the Spinward Front.....	5
Greasing the Wheels of War.....	5
Adeptus Mechanicus.....	6
Adeptus Ministorum.....	8
Ogryns.....	10
Ratlings.....	11

## Chapter I: Defenders of the Imperium

New Regiments.....	15
Abhumans in the Imperial Guard.....	15
The Adeptus Mechanicus.....	15
The Cyprian Huntsmen.....	16
The Orcan Stonecrushers.....	20
The Crimson Guard.....	24
New Regimental Options.....	27
New Home Worlds.....	27
New Training and Doctrines.....	32
New Regimental Drawbacks.....	36
Auxiliary Forces in Only War.....	39

## Chapter II: Specialist Training

Architectus Magna.....	45
Architectus Magna Training.....	46
Architectus Magna Tactics.....	46
Regimental Variations.....	46
Adventure Seeds.....	47
Crimson Exemplar.....	49
Crimson Exemplar Training.....	50
Crimson Exemplar Tactics.....	50
Regimental Variations.....	51
Adventure Seeds.....	51
Enginseer Prime.....	53
Enginseer Prime Training.....	54
Enginseer Prime Tactics.....	54
Regimental Variations.....	55
Adventure Seeds.....	55
Bone 'ead.....	58
Bone 'ead Training.....	59
Bone 'ead Tactics.....	60
Regimental Variations.....	61
Adventure Seeds.....	61
Bulwark.....	62
Bulwark Training.....	63
Bulwark Tactics.....	63
Regimental Variations.....	64
Adventure Seeds.....	65
Gun Luger.....	66
Gun Luger Training.....	67
Gun Luger Tactics.....	67
Regimental Variations.....	68
Adventure Seeds.....	68

Fixer.....	70
Fixer Training.....	71
Fixer Tactics.....	71
Regimental Variations.....	72
Adventure Seeds.....	73
Longshooter.....	74
Longshooter Training.....	75
Longshooter Tactics.....	75
Regimental Variations.....	76
Adventure Seeds.....	77
Trailblazer.....	78
Trailblazer Training.....	79
Trailblazer Tactics.....	79
Regimental Variations.....	80
Adventure Seeds.....	80
Incinerant Priest.....	82
Incinerant Priest Training.....	83
Incinerant Priest Tactics.....	83
Regimental Variations.....	84
Adventure Seeds.....	84
Praeceptor of Penance.....	86
Praeceptor of Penance Training.....	87
Praeceptor of Penance Tactics.....	87
Regimental Variations.....	87
Adventure Seeds.....	88
Prelate-at-Arms.....	90
Prelate-at-Arms Training.....	91
Prelate-at-Arms Tactics.....	91
Regimental Variations.....	92
Adventure Seeds.....	92
Rector Erudite.....	94
Rector Erudite Training.....	95
Rector Erudite Tactics.....	95
Regimental Variations.....	96
Adventure Seeds.....	96

## Chapter III: Fires of Battle

New Talents & Orders.....	101
New Talents.....	101
New Orders.....	110
Enginseer Orders.....	110
Priest Orders.....	112
Ogryn Orders.....	113
Ratling Orders.....	114
Servitor Directives.....	115
New Comrades.....	118
Ogryn Comrades.....	119
Ratling Comrades.....	120
Servitor Comrades.....	121
Extended Armoury.....	125
Ranged Weapons.....	125
Melee Weapons.....	128
Special Issue Ammunition.....	128
Armour & Force Fields.....	130
Cybernetics.....	131
Vehicle Upgrades.....	131
New Imperial Guard Vehicles.....	134

# INTRODUCTION

*"For every guardsman whose boots hit the ground, there is the sage that added his name to the tallies, the Enginseer that blessed his weapon, the priest that blessed his soul, and the countless others. It is these auxiliaries that will see him through to the completion of his holy duty."*

—Lord Marshal Ghanzorik

**S**HIELD OF HUMANITY is a supplement for **ONLY WAR** focused on the auxiliary forces that support the soldiers in the thick of the fighting on the battlefields throughout the galaxy of the 41st millennium. Bolstering the men and women of the Imperial Guard both on the front lines and behind, these specialists take up arms alongside their brethren, forge their engines of war, and fortify their souls against the darkness they face.

## WHAT'S IN THIS BOOK?

This book contains a host of new options for Player Characters, including new regiments and regimental options, Advanced Specialities for Support Specialist characters, and a plethora of new Talents, orders, and wargear. Provided herein are a wealth of options for all characters, and yet more for Tech-Priest Enginseer, Ministorum Priest, Ogryn, and Ratling characters. It also includes rules for new Comrades and a number of new vehicles, providing players with even more options and choices in **ONLY WAR**.

## CHAPTER I: DEFENDERS OF THE IMPERIUM

**Chapter I: Defenders of the Imperium** concerns the regiments of Imperial Guard auxiliary forces. From the Crimson Guard tech-soldiers of the Lathe Worlds to the Ratling scouts of the Cyprian Huntsmen to the Ogryn shock-troopers of the Orcan Stonecrushers, this chapter illuminates the history and the traditions of several regiments seconded to the Imperial Guard. This chapter also includes new options for the Regiment Creation Rules presented in the **ONLY WAR** Core Rulebook, including new Home Worlds, new Doctrines, and new Drawbacks to create Support Specialist regiments and many others. Finally, **Chapter I** presents GMs with guidance on how to run **ONLY WAR** games in which the characters consist entirely of support elements rather than front-line soldiers.

## CHAPTER II: SPECIALIST TRAINING

**Chapter II** introduces Advanced Specialities, new directions for experienced Support Specialist characters that allow them to replace their starting Speciality, either to focus on enhancing specific skills they have already developed or to cultivate new abilities to represent the incredible versatility of Imperial Guard auxiliaries. This chapter includes Advanced Specialities such as the Architectus Magna, Bone 'ead, and Prelate-at-Arms, each of which has access to different Comrades, Advances, Aptitudes, and tools of the trade.

## CHAPTER III: FIRES OF BATTLE

The final chapter of **SHIELD OF HUMANITY** introduces new options for all characters, including an array of new Talents to suit all Specialities and expanded Abhuman Comrades and Servitor Comrade Patterns. As well, **Chapter III** includes new Orders that allow Player Characters to utilise the specialised nature of their new Comrades. It also contains an Extended Armoury with weapons and wargear to equip regiments both old and new. Finally this chapter includes rules for a host of new vehicles that Player Characters can take to the field of battle.



# AUXILIARY FORCES IN THE SPINWARD FRONT

The Imperial Guard is a vast and sprawling organisation, encompassing not just regiments of guardsmen, formations of armoured fighting vehicles, and battalions of artillery, but also legions of support personnel. These are the men and women who provide the core regimental formations of Imperial forces in the Spinward Front with a variety of specialised skills and support, without which they could not hope to operate. Pitted against the Severan Dominate and the reckless aggression of the Ork hordes, it falls to these auxiliary units to take on the jobs that ordinary Imperial Guardsmen cannot accomplish; maintaining their battle tanks, tending to their morale, and providing specialist battlefield expertise in infiltration, fire support, or assault.

It is a great and glorious calling to go to war alongside the armies of the Imperium, and while myriad forces of soldiers and support are constantly at work both behind and on the front lines, each one knows that without its aid the Imperial Guard could not do its job. Unlike the various allied formations a regiment might find itself fighting alongside, ranging from barely trained local planetary defence force formations struggling to survive to shadowy Inquisitorial detachments consumed by their own agendas, these are dedicated support personnel integrated into the regiment. This permanent attachment creates a strange relationship between Guardsman and such forces, but one that often leads to mutual respect and admiration. The Guardsman knows that, without the Engineeer to bless his Chimera, the Confessor to absolve him of his sins, or the Ogryn to lead the assault, he may not long survive the rigours of war.

## GREASING THE WHEELS OF WAR

The number of supporting forces found within almost all Imperial Guard regiments of the Spinward Front is beyond counting: some are there as a result of doctrine others by mere necessity. The most esoteric of these are the red-robed Tech-Priest Engineers of the Adeptus Mechanicus, attached to the Imperial Guard to maintain their vehicles and weaponry. While every Guardsman knows the basics of field stripping his lasgun, has learned safe usage for frag grenades, and often has some training as loader and gunner on heavy weapons, their knowledge of more complex machines is usually lacking. This is especially true when it comes to dealing with the machine spirit of their vehicles, and only an Engineeer can truly soothe the temperament of a Lemman Russ or coax more firepower from a Basilisk artillery piece by speaking directly to the spirit of its machine. As a result, Engineers are constantly at work within the Imperial Guard, moving from company to company repairing, maintaining, and blessing their weapons, and it is often a great honour for a platoon to have such a blessing before battle.

Perhaps of equal importance to the Engineers of the Adeptus Mechanicus are the Priests of the Ministorum, who maintain the morale and protect the souls of the guardsmen under their care. While every Guardsman swears an oath to the Emperor and carries the righteous faith of the Imperial Creed in his heart, the horrors of war can often erode that faith and eat away at his convictions. Within the Spinward Front the existence of the Severan Dominate makes this war of faith especially deadly, as guardsmen are frequently exposed to traitors, xenos sympathisers and heretics. To protect them against the taint of these ideas and philosophies, Priests must be ever-vigilant for signs of dissension among their charges, and maintain the rhetoric of the Imperial Creed at all times. When a weak link in the chain of faith is uncovered, it falls to the Priests of the Ministorum to repair it or, if they cannot, remove it altogether lest it spread and multiply. Priests are also of great value on the battlefield, where their presence acts as a beacon of faith, steadying their comrade's morale and show them that even in the darkest of places the light of the Emperor shines bright.

Alongside Priests and Engineers, abhumans are the next most common group found fighting alongside the Imperial Guard. The most oft-encountered of these are the diminutive Ratlings and the towering Ogryns. These abhumans are among the few Imperial sanctioned human variants allowed to fight in the Imperial Guard. Such is the usefulness of their specialised skills, and the reputation they have earned, that they can be found throughout the Spinward Front, fighting on scores of its worlds and battlefields, lending their abilities to the great conflict to bring the Front back into Imperial control.

Whether Engineeer, Priest, or abhuman, the auxiliary forces of the Spinward Front are a vital part of the efforts to cleanse the sector of alien filth and heretic worlds, and their stories and achievements are just as glorious as any within the armies of the Emperor.



## ADEPTUS MECHANICUS

Every Imperial formation can usually call upon the support of the Adeptus Mechanicus to repair and maintain its vehicles. Objects of mystery and even distrust, the Enginseers, in their closed armour and heavy robes, usually stand apart from the regular guardsmen. Sometimes though, circumstances draw an Enginseer to the fore, and he will earn a reputation through deeds of valour and dedication to the cause.

### RAKAN TESIL, ENGINSEER 112TH SCINTILLIAN, ATTACHED

Countless Enginseers toil endlessly in the armies of the Emperor to keep the Imperium's great war machine alive. Many guardsmen take these mysterious yet vital auxiliaries for granted, most believing—correctly—that their cult's mysticism and secrecy keep the red priests forever apart from their unenlightened comrades. It is therefore rare for an Enginseer to form any kind of bond with the platoon or company in which he serves. However, amongst the 112th Scintillian, Rakan Tesil is spoken of with awe and admiration, the tales of his service to the regiment common campfire conversation fodder. Stories tell of Tesil walking through storms of enemy fire or explosions to affect battlefield repairs on a damaged tank or transport. The robed Enginseer displays the typical detachment of the Adeptus Mechanicus as he welds tracks back into place or coaxes engines back to life. Scintillian guardsmen cowering in cover will often look on in amazement as Tesil walks out into the open, las-blasts and shrapnel plucking at his robe, in order to retrieve

an ancient weapon or repair a prized vehicle. In one such account while the 112th were fighting against a massed mob of Orks in the blasted ruins of Kulth, Tesil and a group of his servitors exposed themselves to barrage after barrage of xenos rocket fire to repair the Hydra Flak platform *Scythe of Light*. Though every single servitor was blasted to chunks of meat and metal, Tesil survived unharmed, restoring the gun and turning it on the xenos with murderous effect.

Few doubt that Tesil is indeed blessed by the Omnissiah, for his tech-works are certainly favoured in some way. Those within the 112th can attest to Tesil's courage and each trooper has a story that exemplifies his valour on behalf of the regiment's war machines. It is even said that machine-spirits are never quite the same once he has communed with them, their function and language seeming bolstered and strengthened. Of course, guardsmen largely accept the mystery surrounding the servants of the Machine God and so such superstitions concerning Rakan Tesil spread swiftly through the 112th. To this day, the agents of the Omnissiah amongst the regiment have not deigned to address these rumours, a fact which of course only leads the guardsmen to believe in their own truth.

### 14TH LATHE WORLD ARTILLERY CORPS

The Imperial Guard is rightly feared for the strength and size of its artillery. Even the smallest regiments can usually muster a formidable array of guns with which to hammer the foe into submission. The Lathe Worlds are some of the richest within the Calixis sector and produce an impressive range of tanks, guns, and munitions for the Imperial Guard, a great deal of which finds its way to the Spinward Front. Basilisk self-propelled guns, Manticore multiple missile launchers, and siege bombardments all roll out of its manufactorums in staggering numbers. While most of these artillery pieces are divided among the divisions and regiments of the Imperial Guard, particularly fine examples are sometimes grouped together and sent to a wealthy or important regiment at the behest of the Lord Marshal.

One such example is the 14th Lathe World Artillery Corps. Attached to the Scintillian 17th, it contains four full batteries of Basilisk self-propelled guns, with a battery of Deathstrike Missile Launchers in support. While the weapons are of finer quality than most, bearing the blessing of the Omnissiah and festooned with charms and Mechanicum machine prayers, the thing that makes the corps stand out is its crew. Whereas most artillery is serviced by men and women drawn directly from the attached regiment and overseen by Enginseers, the 14th Lathe World Artillery Corps has its crew drawn from the Lathe Worlds themselves. This is the result not just of the rare forging of the guns and the portents which blessed them, but also the fact that it would be almost blasphemy for the hands of the uninitiated or unfaithful to load, fire, and care for them. As a result the Corps bears its own name independent of its regiment, and is crewed by servitors, fused bodily to their artillery pieces, and guided by a Tech-Priest Enginseer. While the Corps remains highly unusual among the artillery of the Imperial Guard of the Periphery, none can deny its deadly accuracy and impressive kill tally.



*Divisional Adeptus: Kulfh Front Report Sub-Secundus 113th  
Reporting/Responding Officer: Commissar Daedrus Koth  
Thought for the Day: Trust Not the Soulless Machine*

*The presence of the Adeptus Mechanicus in our ranks has never sat well with me, and though I understand the need for Engineers as part of the Imperial Guard, their soulless demeanour and hidden agendas always keep me on edge. I feel my mistrust is well-founded as on numerous occasions their double dealing have left a bad taste in my mouth; my most recent deployment yet another mark against them in my book. It was during the recent xenos purge on Gnaf Magna, where my regiment was deployed to the upper workings of the Hidris Mine to combat infiltration by feral Orks. Tunnel fighting is a bloody business, especially against such a vile and bestial foe as the Orks, and this was no exception. Though we were pushing the Orks back, every day we suffered higher casualties and numerous platoons were dropping to almost ineffective levels while others had to be folded into single formations of odds and ends to keep fighting. What at first alarmed me was not the loss of life, a part of service in the Imperial Guard and our due to the Emperor, but rather that the mine's Tech-Priests were taking control of dealing with the dead. Claiming contaminants in the mines, and the need to stop the spread of disease, the followers of the Machine God rebuffed my investigations. The guardsmen would shudder at the sight of the Tech-Priests and their servitors, their arrival heralding the loading of suspensor-carts with bodies. Regardless I continued to investigate the Mechanicus' role on Gnaf Magna, especially when my own superiors seemed so supremely disinterested. It seems that my fears were somewhat founded when I by chance encountered a servitor in the depths of the Hidris Mine, its face strangely familiar. Only when I examined the creature and saw the faded lines of Imperial Guard regimental tattoos on his pallid flesh did I realise just from where.*

INTRODUCTION

## PRIMARIS MAGOS BIOLOGIS EXPEDITION

The Adeptus Mechanicus remains aloof from the armies of the Imperium, even though it lends its support to countless regiments and conflicts all across the Galaxy. It is this detachment that sows distrust and ill will between Imperial Guard officers and the Mechanicum, many guardsmen and their superiors are naturally wary of the motivations and actions of these strange robed men. Organisations like the Primaris Magos Biologis do little to dispel these notions. The Magos Biologis are active in many systems of the Periphery and on scores of worlds. From the acidic crags of Nox to the wilds of Horizon, teams of Tech Magos and their servitor cadres conduct digs, carry out complex surveys, and hunt down and retrieve indigenous life forms for study. Even in the heart of some of the bloodiest warzones they sometimes go about their secret missions, their purpose seldom revealed to the Imperial Guard.

What is most galling for Imperial officers, though, is not the secrecy the Magos Biologis surround themselves with, or even the disregard they tend to display toward anyone not of the Mechanicum, but rather the fact that they will sequester Imperial Guard units for their own ends. While the Imperial Guard regiments of the Spinward Front have no formal obligation to aid the Adeptus Mechanicus, they are still beholden to the orders of the Lord Marshal, and unfortunately, the Primaris Expedition has great influence with Sector Lord Hax and, by extension, Ghanzorik. This all means that Magos often carry the Lord Marshal's seal and can demand support from available Imperial Guard assets. Guardsmen that are drawn into one of the Primaris' expeditions always returned changed, if they return at all, whispering tales of terrible beasts, strange tombs, or mind breaking artefacts. It is certain that the Magos Biologis have a secret agenda in the Periphery, and though they may lend aid to the Imperial Guard from time to time, their motives remain their own.

## ADEPTUS MINISTORUM

Faith is an important part of the Imperial Guard and its oath to the God-Emperor. As the guardians of this faith, Priests are present whenever guardsmen must be tested, to strengthen their resolve and judge them if they are found wanting. In times of great peril and hardship, some Priests stand tall among their brethren, single-handedly turning the tide of a battle or defeating a great foe.

### CONFESSOR HELMOR KRASS

Confessors are the burning heart of an Imperial Guardsman's faith, stirring him to great deeds and steadying him in the face of terrible odds. Many Confessors consequently have a very short life-span, leading from the front and being the first to charge into the fray, so it is not surprising that those who survive earn formidable reputations. One such devotee of the Imperial Creed is Confessor Helmor Krass, attached to the Cadian 212th Shock Infantry Division. Covered in the scars of a hundred battles, Helmor's grizzled face can stop a man in his tracks with just a look. His vestments are as torn and tattered as his flesh, hanging in blood-stained rags

about his powerful frame. The one thing that has not been diminished by his trials in combat is the fire of faith that burns brightly in his eyes and seems to radiate out from him. It is said that the mere presence of the Confessor on the battlefield can incite rage in Imperial Guardsmen, his deep disdain for the alien, heretic, and mutant are instantly infectious.

Before he was attached to the 212th, the tale goes that Helmor served with the Drusians in the first battles of the Achilus Crusade, against the dread forces of Chaos. Though his entire regiment was destroyed, Helmor alone returned, drenched in the blood of his foes, the motors of his chainsword clogged with the gore of his enemies. Relocated to a new regiment, Helmor's fury could not be abated. Such is his righteous hatred of the enemies of mankind, those who would profane all that the Emperor has built, that when faced with such foes, the Confessor loses all thought of survival or preservation. Confronted with the darkness of heresy or betrayal, Helmor's wrath is unmatched, his mercy offered only in bloodletting.

*Divisional Adeptus: Kulth Front Report Sub-Secundus 113th  
Reporting/Responding Officer: Commissar Daedrus Koth  
Thought for the Day: Heresy is the Child of Free Thought*

*I was inspecting the ramparts this morning along the dust fronts when our section of the line came under sudden and precise shelling. I immediately jumped down into a trench to protect myself from the seditionist shells that were falling all around us. Picking myself up from the dirt, I noticed that I was surrounded by men cowering from the explosions, their faces pressed to the ground. I was just about to unholster my bolt pistol and teach them some courage when a figure stepped out of the dust before me, robed in the vestments of the Ministorum and clutching an Aquila pendant in his fist. "They fear the shells because they do not believe the Emperor will save them," he told me. He then said "I can only lead by example." He pointed out toward a ridge in the distance where I could make out the faint glint of a ranging-glass. With that he leapt up out of the trench and ran toward what I assumed was the forward observer for the seditionist artillery. I was sure he would be torn apart before he had taken ten steps, but somehow he ran on, the violent geysers of earth rising up all around but never touching him. By the time he had reached the ridge, I was accompanied by most of the platoon, all now pressed to the edge of the trench heedless of the shelling. As I watched, the priest charged a figure getting up from cover and trying to take flight: the seditionist observer.*

*Along with the guardsmen, I cheered and yelled encouragement as the priest caught the observer and beat him to the ground, armed only with the aquila pendant held tightly in his fist. Then suddenly, a lasbolt from beyond the ridge cut down the priest, prompting a disbelieving cry from the guardsmen. For a heartbeat, nothing happened. Then one of the guardsmen climbed out of the trench, ignoring the artillery, and ran toward the ridge, followed a moment later by the rest of his platoon. Emperor help me, I charged with them.*

## DAUGHTERS OF THE DYING LIGHT

An army of priests, confessors, clerics and lay-healers attend to the needs of the regiments of the Spinward Front. The Daughters of the Dying Light tend to the dead and dying of the battlefield. They are primarily concerned not with healing or preserving life, but with easing the passing of another soul into the care of the God-Emperor. Dressed in flowing crimson robes, the Daughters are a strange sight on the battlefield, moving from fallen man to fallen man, whispering in their ear before touching them gently on the cheek in a gesture of farewell. That none who draw the attention of the Daughters of the Dying Light seem to recover or even linger once the daughter moves on has largely escaped the notice of the guardsmen who have witnessed them. Rather, most marvel at their ability to stand amidst a storm of enemy fire and remain unscathed, appearing to know intuitively which men are close to death and which will recover. It has become an unspoken rule among the medics of the Spinward Front regiments that if a Daughter is tending to a man then the medic should move on, as that soldier is beyond his skill to save.

No one knows for sure where the Daughters of the Dying Light came from. Some claim they are a splinter faction of the Drusians, while others say that they were a hospitaller cult that somehow found its way into the crusade fleets. Whatever the reason, they have become firmly entrenched within the war zones and fronts of the Periphery, shadowing the Ministorum wherever it makes itself known and often reaching the worse battlefields before them. To the Imperial Guardsmen of the Spinward Front, the Daughters are both saviours and grim reapers—soldiers are grateful for their help in easing the passing of the dead, but ever fearful of having to hear one whisper in their ear. Just what the Daughters say to the dying is also a mystery, though whatever words pass their lips seem to ease the pain of the fallen soldier. To most guardsmen, however, the Daughters are accepted as just another oddity of war, and a final mercy in their dying moments.

## VOICE OF THE EMPEROR

Blessed are those that speak the Word of the God-Emperor and blessed are those that can hear them. Such is the power of the Emperor's holy word that there are those priests that do nothing but preach it on the battlefield. The Voice of the Emperor is such a formation, men and women of the faith augmented by vox-casters, sometimes sown into their mouths or eyes, and laud hailer arrays grafted to their backs. The Priests of the Voice walk among the Imperial Guard regiments of such worlds as Kulth and Lukius, their booming, crackling voices echoing across the battlefield endlessly intoning the blessed texts of the Ministorum.



Even in battle, over the crack of las-fire or the hammering of bolter rounds, they continue the endless chant, their voices raised desperately high in the face of death. For a guardsman sheltering in his foxhole or cowering on the floor of a gore-stained trench, the sounds is uplifting, and more than one soldier has reported seeing glorious visions upon hearing the Word drifting to them across the bullet-torn battleground.

While a single priest of the Voice can stir the faith of a single Guardsman or rally a routing unit, they are most impressive when gathered together in choirs. Hundreds and sometimes even thousands of priests will gather their voices in a single booming prayer. Such is the power of this incantation that it has been known to inspire men to acts of insane valour and bravery, hurling themselves into the teeth of enemy fire, or fighting on with their bodies mangled by terrible wounds. It is even rumoured that such a vast gathering of the Voice of the Emperor can nullify enemy psykers, and stories tell of Ork Weirdboyz being robbed of power or Eldar warlocks having their magicks fail. Most impressive of all the tales of the power of these priests is that, in great enough numbers, they can even banish Daemons, the righteous fury of the holy Word casting the hell-spawn howling back into the Warp.

## OGRYNS

Ogryns stand in stark contrast to Ratlings. Where the Ratling is small and physically weak, the Ogryn is an unsubtle, towering mountain of muscle. Where the Ratling is careful and cautious, the Ogryn blunders around crushing everything in its path. What they lack in stealth and caution Ogryns more than make up for in size and strength, standing almost twice the height of a man and three times as broad across. Ogryns have found their place upon the battlefield in assaults and close combat actions where their brawn is most useful. Many Ogryns live up to this ideal and, armed with enormous melee weapons and hefting their immense bulk into mobile walls on the battlefield, as strong as many a fortification. Unfortunately, all of an Ogryn's might comes at the cost of his mind, and they are notoriously dim-witted, requiring close supervision by officers and commissars to complete their tasks. Even the Ogryn Bone 'eads are only slightly brighter, though enough so to mark them out as officers and leaders among their kind.

Ogryn squads are a rare and valued commodity among the Imperial commanders of the Spinward Front, and to have access to them is often the result of earning favour from above, or a measure of the importance of the task at hand. While almost all guardsmen view an Ogryn's strength and endurance with awe, there are some among these hardy abhumans who have distinguished themselves further.

### 51ST ABHUMAN PENAL SUPPRESSION DETACHMENT

Ogryns are not just valued as bodyguards and shock troops but can also be put to use as wardens in rare instances. While lacking the intelligence to be truly effective, their size and strength can compensate as long as they are given clear instructions. The 51st Abhuman Penal Suppression Detachment is made up of those Ogryns deemed unfit for frontline duty, either due to permanent injury, or exceptionally limited intellect (even for Ogryns) The Administratum within the Spinward Front has put these "damaged" Ogryns to work aboard the prison barge *Oath of Judgement* as wardens. The vessel routinely travels around the sector taking on military prisoners, guardsmen who have failed to adhere to the strict regulations of their regiment or committed some minor crime that was undeserving of summary execution.

The upper decks of the vessel remain sealed at all times and the Ogryns patrol the lower decks with the prisoners, told to keep anyone smaller than themselves from causing trouble. So far this practice has worked, with the prisoners for the most part intimidated by the abhumans and the Ogryns too stupid to fall for any of their tricks. On occasion the Suppression Detachment is also used in a policing role on Imperial Navy vessels or Imperial Guard bases, where their heavy handed tactics can be used to quell riots and round up criminals. However, this is usually a last resort, as the abhumans have trouble telling the real troublemakers from bystanders and more than one Guardsman has been caught up in a disturbance only to get knocked around the back of the head with a meaty fist and wake up in the hold of the *Judgement*.



### 1636TH IRONARM BULWARK SQUAD

The Imperial Guard regiments of Cadia constitute a large proportion of those forces fighting in the Spinward Front. Many of these Shock Troop formations arrive with their own abhuman detachments in tow, having served alongside them in other sectors. The 1636th Ironarm Bulwark Squad has fought with the Cadian 818th Shock Troops for at least a decade, the lumbering Ogryn's of the squad forming fast bonds with the guardsmen. In battle, the Ironarm Bulwark Squad is used for holding actions and shock assaults, their mighty slab shields and mauls smashing into enemy formations or holding them at bay.

In the Battle for Bridge 212, the Ironarms proved their worth time and again as they held back the rampaging Ork forces of Waaagh! Grimtoof. Three times the Goff warbands tried to cross the bridge and three times the Ogryns threw them back, the towering abhumans cracking green skulls in a brutally efficient fashion.

There are several stories as to how the Ironarms got their designation of 1636th, considering that Ogryn squads are so few in number. One tale has it that the squad was originally destined for the 1636th Cadian Shock Regiment in the Jericho Reach as part of the Achilus Crusade but was diverted at the last minute, perhaps as the result of an Administratum error. Another maintains that it is even simpler than that, and when the squad Bone 'ead learned he was joining a regiment called the 818th he should be the 1636th because he was twice the size of any Guardsman.

## OATH-BOUND BODYGUARD

Ogryns make excellent bodyguards for they are loyal, determined, and extremely hard to kill. Among the officer cadres of Lord Marshal Ghanzorik's regimental commands, it is a great honour to have an oath-bound Ogryn bodyguard. Normally, Ogryns are such a valuable asset that they are formed into squads and used as shock troops or blocking detachments, but sometimes a high-ranking officer manages to requisition one for his own personal retinue. In the same way that officers sometimes have advisors from other arms of a crusade or Imperial force, an Ogryn can end up shadowing a captain, colonel, or general as they take a journey to the front to inspect the war. Imperial officers also take great pleasure in the intimidation factor that an Ogryn brings to any tactical briefing or even social engagement, the towering abhumans making everyone in the room painfully aware of their own insignificance.

Rarer still are those instances where an Ogryn will form a bond of fellowship with a low-ranking officer or even regular guardsmen. The simple minds of these hulking abhumans can for reasons unknown become fixated upon a particular human, especially if that human shows them kindness (or just happens to be in the right place at the right time). Once an Ogryn connects with an Imperial soldier in this way, the bond becomes almost unbreakable. Reports from the Spinward Front confirm that this has happened on several occasions, with charismatic and courageous junior officers acquiring for themselves the undying loyalty of one of the abhuman shock troopers.



## RATLINGS

Ratlings are most often used for stealth or sniper duties, their size and natural skill at marksmanship making them ideal for these tasks. Able to slip across a warzone unseen, a Ratling can go where a man might not, and escape notice from the enemies of the Imperium, allowing the scout to find a perfect position from which to pick off its targets. Off the battlefield, in the camps and onboard the massive transport vessels used to ferry countless soldiers from one corner of the galaxy to the next, Ratlings are also favoured for their skills with food, something always of interest to the poorly fed guardsmen of the Front. This makes them well received by most regiments for their ability to do miraculous things with corpse-starch rations, which often barely qualify as food. Other guardsmen, however, are more wary of having Ratlings amongst their number, as the tiny abhumans have a reputation as black marketeers and scavengers of great skill—this means Ratlings are usually the first to blame if spare ammunition or stashed rations go missing around the base.

There are numerous Ratling companies within the Spinward front, though these are usually broken down into squads or even individual specialists and integrated into the numerous regiments and warzones of the sector. Even amongst the myriad warzones of the Spinward Front there are some famous Ratling units whose remarkable deeds have earned them grand reputations.

## BIGBY QUICKFINGER

Ratlings are rightly renowned for their talent with long rifles and sniper weaponry of all kinds and it is said that, even as whelplings, they can shoot the flies off the back of a Grox at a hundred paces. In the ruined cities and wilderness warzones of the Spinward Front, Imperial Guard regiments are lucky if they receive support from Ratling platoons and squads, these valuable resources handed out sparingly by Lord Marshal Ghanzorik. They are even luckier still if they happen to find themselves fighting alongside Bigby Quickfinger.

A veteran of the first battles of Kulth, Bigby made his first kill within ten minutes of stepping off his lander. No sooner had he been handed his weapon than he spied a secessionist scout observing the mustering. Snapping off a shot at some 800 metres and dropping the scout, he reportedly remarked that the weapon was pulling a little to the left, and set about adjusting the sight.

Since his time on Kulth, Bigby has travelled to many of the warzones of the Front, racking up an impressive number of kills including numerous high ranking members of the Severan Dominate and several Ork bosses. He has also aided in the support of specialist forces, such as the Storm Trooper regiment, providing vital covering fire for incursions into enemy territory. This has earned him the nickname of "Quickfinger" for his lightning reflexes and feather touch on the trigger. This skilled sniper always knows just when to squeeze off the shot to bring down his prey.

## CRADDOCK'S RANGERS

In addition to their skill with ranged weaponry Ratlings are also natural infiltrators. Few soldiers can tread as softly as a Ratling or get into the tiny spaces of the little, hairy-toed Imperial soldiers. Some of the best infiltrators in the Imperial forces of the Spinward Front can be found in the Craddock's Rangers. A collection of the sneakiest Ratlings to ever aid the Imperial Guard, they were originally gathered together to aid in the infiltration of the Severan fortress on Lukius. After exceeding expectations, the squad was kept active and has become highly sought-after for any missions requiring infiltration behind enemy lines.

Unfortunately for the Imperial Guard, the Craddock's Rangers also have a reputation for stealing anything that isn't nailed down, including Imperial Guard supplies. Time and again, the unit has been brought up on charges, but each time the contraband or stolen goods have mysteriously disappeared. Even so, when the Rangers join an Imperial Guard regiment, word soon gets around that if you want something, and don't mind not asking too many questions about where it has come from, then they can probably get it for you. Some of the more outrageous stories about the Rangers has them looting enemy vehicles and weapons from the battlefield, sometimes for profit, but often just for idle amusement. One such tale concerns the Baneblade *Badge of Freedom*, which was used by the secessionists on Lukius. Stolen from a Severan armoury, the tank was later found on its side, driven into the foundation of the grand-wash bridge, though nobody seemed quite sure how it got there.

## 412TH MUNITORUM SUPPLY DIVISION

Not all Ratlings are utilised in the front lines; some are employed by the Munitorum or Administratum for support roles, most commonly as cooks. The cost of a few supplies going missing from time to time is a small one when compared to what a Ratling can do with corpse starch rations, not to mention local wildlife. Most regimental commanders are happy to have the little abhumans attached to their formations for the morale alone, and more than one colonel has pulled rank to get a Ratling chef transferred to his platoon permanently.

One such Ratling supply division is the 412th Munitorum stationed on Kalf. On such a dry and arid world, it is little wonder than there is nothing particularly exciting to eat and in the staging areas where forces are mustered before going on to Kulth. The 412th has developed a marvellous recipe for Kalfian Sand Devil using some of its rare and tender organs for a particularly tasty broth. The only problem is that the Ratlings cannot catch the Sand Devils themselves, and so rely on brave guardsmen willing to sneak off into the desert and bring one or more back. It is a dangerous task that risks not only life and limb but also possible court martial or summary execution for desertion. The fact that guardsmen still brave these perils is a testament to the culinary skills of the 412th.

*Divisional Adeptus: Kulth Front Report Sub-Secundus 113th  
Reporting/Responding Officer: Commissar Daedrus Koth  
Thought for the Day: Courage Comes from Duty*

*I have rarely had cause to praise our abhuman allies; the small ones are notorious thieves and liars, while the big ones are almost universally foul-smelling and dim-witted. However, during a routine patrol in the Salacian ruins three cycles ago, I found myself thankful of the presence of a Ratling. My platoon had been sent out to locate the forward elements of the rebel position within the ruins, and we had spent most of the day simply trying to pick our way through the broken hab-blocks and twisted debris. The area had seen heavy fighting and the burnout wrecks of various vehicles were littered about the place along with discarded clips, damaged helmets, and other wargear left behind by both our forces and the secessionists. We had just found our way into an open area between what was once two sub-manufactorums when we came under heavy stubber fire from a concealed bunker. Going to ground in the husk of a partially intact Chimera, my squad tried to return fire but was frustrated by shots coming from another concealed bunker. It was at this point that I discovered that we shared our improved cover with a diminutive figure. At first I thought it was some form of rebel mutant and had my bolt pistol half drawn when the Ratling came into the light and introduced himself as Quickfinger, part of the 17th Forward Abhuman Division. As the hard rounds of the stubbers sparked and clanged off the Chimera hull, Bigby related to me how he had been scavenging for the regiment (or so he claimed) when he'd decided to take a rest in the Chimera, only to then be rudely awakened by our arrival and the fire from bunkers. When I told him we might well be pinned down here until we could vox for support, he hefted a rather ornate sniper weapon and asked that I give him a minute. Using the vision slits of the wreck Bigby fired four shots, twice at each bunker, and guns immediately fell silent. With the bunkers out of action, he then asked if we could kindly leave him to finish his nap.*



# DEFENDERS OF THE IMPERIUM



NEW REGIMENTS  
•  
NEW REGIMENTAL  
OPTIONS  
•  
AUXILIARY  
FORCES IN  
ONLY WAR

# CHAPTER I: DEFENDERS OF THE IMPERIUM

*"A man can ask for no greater gift than a glorious death in the service of the Emperor and the protection of Mankind."*

—Confessor Shiloh Norvus

**T**he ONLY WAR Core Rulebook presents a number of renowned Regiments hailing from across the Imperium as well as in-depth rules for Regiment creation, affording players and GMs numerous options. This chapter expands on that content with three new Regiments and numerous options for Regiment creation, including new home worlds, training and equipment doctrines, and regimental drawbacks—detrimental options that grant additional Regiment Creation points to spend on doctrines. In addition to these extra points, drawbacks grant numerous opportunities to enhance roleplaying experiences and uniquely define a Regiment.

The new Regiments in this chapter are drastically different from previous Regiments. Two consisting entirely of abhumans and a third, the Crimson Guard of the Lathe Worlds, that is not a true Imperial Guard force at all, but rather represents the militant might of the Adeptus Mechanicus' sovereign domains. Choosing one of these Regiments promises a very different campaign than one that uses a more traditional Imperial Guard Regiment. While these Regiments excel in certain areas, they are also clearly limited in some ways. For groups that wish to have a more well-rounded squad, a discussion of variant group formations beginning on page 39 allow players to bring together characters from vastly different backgrounds to fight together in the name of the Emperor.

Accompanying these new Regiments are a variety of additional options for Regiment creation, further broadening the range of options available to players and GMs. These options include new Home Worlds and Origins, such as shrine orlds and void born. Two new options, Ogryn worlds and Ratling worlds, are radically different from previous Home World options, allowing for Regiments entirely consisting of abhumans. Using these options, players can all take on unique roles in the squad while playing abhuman characters. New doctrines allow for an increased variety of Regiments, with new Regiment types such Rapid Reconnaissance—allowing each Player Character to race into battle mounted on a Tauros—or a Super-heavy Armoured Regiment—in which the Squad crew a mighty Baneblade super-heavy tank. New Training and Special Equipment Doctrines add more options, allowing for even further customisation and unique Regiments. Options such as Defenders of the Faith, Snipers, Bonded to the Machine-Cult, and Servitor Accompaniment allow for truly distinctive

Regiments, showcasing the great influence of the Adeptus Mechanicus and Ecclesiarchy and their representatives on the Imperial Guard. Regimental Drawbacks are an additional option for players and GMs during Regiment creation. Taking a Drawback submits a regiment to certain penalties, but grant additional Regiment Creation points to spend on Doctrines or additional Standard Regimental Kit. Drawbacks also serve to further define a regiment and make it unique amongst the countless forces of the Imperial Guard. Drawbacks such as Iconoclasts and Traitors illustrate the regiment's relationship with the institutions of the Imperium, and lead to new and exciting storytelling options.

Finally, this chapter concludes with a discussion of the diverse backgrounds that unite under a single banner to serve the Imperium and how a Game Master might incorporate such elements into his campaign. This section covers a variety of situations, from "mongrel" regiments formed from the tattered survivors of multiple regiments to squads formed from various specialists pulled from across a battlefield to perform a specific task, to Player Character squads made up entirely of support specialists and the challenges that such a group might face. The final section of this chapter provides a number of new options for Game Masters and players alike, allowing for new configurations and new stories of soldiers with diverse ideologies and methods serving the same cause on the brutal battlefields of the 41st Millennium.



# NEW REGIMENTS

*"Here's a piece of advice if you're going to be serving alongside those runts—watch your pockets."*

—Lance-Corporal Holf Arven

Instead of creating their characters' regiment, players may choose one of the following. These present examples of what players can do with the new Regiment Creation options that follow later in the chapter. Each entry outlines a brief history of the regiment and its founding, its signature combat tactics and equipment, and the part it is currently playing in the Spinward Front. These Regiments were created using the Regiment Creation rules found on page 58 of the **ONLY WAR** Core Rulebook in combination with the new regimental options beginning on page 27 of this book.

## ABHUMANS IN THE IMPERIAL GUARD

Abhumans represent stable mutant strains that, while significantly diverged from their human ancestors, are judged genetically sound and no more prone to further mutation than the basic human population. While the Adeptus Terra recognises seventy-three stable abhuman strains, the two most common and most visible are Ogryns and Ratlings. This is particularly true in the Imperial Guard, which drafts regiments of Ogryn and Ratling auxilia for their particular capabilities.

It is, perhaps, an irony that abhuman regiments must fight and die in the defence of a populace that, by and large, distrusts, looks down on, and even despises them for failing to adhere to the human norm. The Ecclesiarchy preaches that the form of Man is sacred, and that mutation is a blasphemy against that pure form and a reflection of spiritual corruption. While there has been much debate through the millennia over what exactly abhumans are, the official stance is that they are not mutants but, as the word suggests, divergent strains of humanity. However, acceptance of abhumans remains difficult to reconcile with the teachings of the Adeptus Ministorum.

Abhumans almost invariably evolved in isolation, resulting in particular abhuman home worlds. In some cases, ordinary humans have since come to populate these worlds alongside the abhumans, while others remain solely the domain of the native abhuman population. Most abhuman strains developed during the long millennia between the Dark Age of Technology, when Humanity spread across the stars and colonised uncounted worlds, and the Age of the Imperium. During the dark years of the Age of Strife, many worlds were completely cut off from other human planets. This isolation bred distinctive traits in those populations. Some worlds, due to a particular environmental quirk, produced radically divergent inhabitants that, while human, are so different from Man's original form as to present a unique strain. These abhumans have met with a variety of attitudes and persecutions in the millennia since the Great Crusade, and Mankind's many subsequent crusades, rediscovered their lost worlds.



## THE ADEPTUS MECHANICUS

The Adeptus Mechanicus has a complex relationship with the Imperial Guard, as it does with many Imperial institutions. The Adeptus Mechanicus is not subservient to the Departmento Munitorum, but the Departmento Munitorum does rely on the Adeptus Mechanicus for the supply and maintenance of the more sophisticated of its tools. While lasguns can be manufactured in massive numbers by most any hive world with the proper resources, the esoteric secrets of plasma technology and super-heavy tanks are the purview solely of the Tech-Priests.

When the forces of the Imperial Guard go to war, the Enginseers and other Tech-Priests accompany them, seeing to the proper keeping of the machines and technology of war. The Enginseers see to the proper treatment and maintenance of the Imperial Guard's vehicles and other equipment, risking their lives on the battlefield to conduct immediate repairs as necessary. To the common Guardsmen, the Enginseers are mysterious figures, aloof in their red robes. Tech-Priests come from a very different background than any Guardsman, and even those raised on a technologically advanced world have little in common with the members of the Martian Priesthood. That experienced Enginseers are often more machine than man only exacerbates the issue of communication, as their metal visage leaves common Guardsmen uncomfortable.

While it is commonly professed that the Adeptus Mechanicus pays worship to the Emperor in his aspect as the source of all knowledge, the Omnissiah, the drastic differences in their religious beliefs often put the Ecclesiarchy and Adeptus Mechanicus at odds. On a local scale, the differing responsibilities of the representatives of both organisations tend to keep them apart, as Tech-Priests tend to the vehicles and machines and Adeptus Ministorum priests tend to the spiritual needs of the Guardsmen. Sometimes, however, particularly in armoured or mechanised regiments or those with strong ties to the Mechanicus, the agents of the Ecclesiarchy can cause some tension.

# THE CYPRIAN HUNTSMEN

*"I think I speak for most of the boys when I say that we're more worried about running out of rations than we are of running into the enemy."*

—Sergeant Gip Hendersnoot

Cyprian's Gate is a Ratling home world located in the Hazeroth Abyss Subsector of Calixis. This verdant world particularly stands out from the other planets of the Hazeroth Abyss, which has a reputation as a cold and desolate region. Classified as a pleasure world due to idyllic environs and lack of industrialisation or dangerous flora and fauna, it is a retreat for nobles from across the sector, from the spires of Scintilla to the manses of Malfi. The surface of Cyprian's Gate is covered largely in temperate grasslands and forest, while a high mountain chain divides the main continent. Frozen caps cover both poles, and needless to say the native Ratlings avoid these inhospitable areas, preferring the rich farmland of the equatorial regions. Compared to many worlds in the sector, Cyprian's Gate is distinctly lacking in exploitable natural resources, with no valuable ores, gases, or other compounds to speak of. It is also notably lacking an exploitable workforce, for Ratlings are ill-suited to manual labour even when pressed to the task. This, in combination with the desires of the Calixian nobility to maintain unspoilt regions for their own private sanctuary, explains the lack of industrialisation or other development of Cyprian's Gate.

For generations, tensions have existed between the visiting nobility and the native Ratlings. While personable, the Ratlings lack the social decorum which the nobles expect, failing to show what the nobility consider due deference. In addition, the nobles regularly level accusations of theft at the natives. Of course, Ratlings are known for their light fingers with good reason, and there is doubtless some veracity to these claims. Despite these tensions, many Ratlings find employment as the personal chefs of nobles, or in other servile duties. However, many Ratlings resent the pompous attitudes of the nobility, and even those in their employ tend to be less than completely loyal. Those who do please their off-world masters (particularly as chefs) sometimes find themselves whisked away from their home to continue serving a noble after his vacation comes to an end,

possibly finding themselves on a world halfway across the sector before they quite realise what is happening.

With little else to offer the Imperium, Cyprian's Gate pays the Imperial tithe primarily in the form of soldiers for the Imperial Guard. Even so, this tithe is still much smaller than many worlds, owing to poor Administratum record-keeping and a fluctuating and poorly monitored population level. It is also possible that the sector nobility, in order to keep their lush playground in ideal condition, have pulled strings to ensure minimal tithing. To date, fewer than a dozen regiments have been raised from Cyprian's Gate—the exact number is unclear due to conflicting and missing Administratum records. As with most Ratling home worlds, the majority of regiments raised from Cyprian's Gate are trained and equipped as snipers, categorised as either light infantry or reconnaissance regiments in Departmento Munitorum records. Although the Ratlings of Cyprian's Gate think little of military discipline or the regimented formality of the Imperial Guard, their abhuman nature leaves them well-suited to the role of snipers. In fact, the native Ratlings do hone their hunting skills extensively. While tame compared to many worlds of the Imperium, Cyprian's Gate has its share of dangerous creatures (at least, dangerous to a one-metre tall Ratling), some of which are actually quite delicious, in the natives' opinion. The Ratling communities organise volunteer militia forces to



## REGIMENT RULES

Characters belonging to the Cyprian Huntsmen possess the following advantages:

**Characteristic Modifiers:** +2 Ballistic Skill, +10 Perception, +5 Fellowship, +8 Agility, -5 Strength, -13 Toughness, and an additional +3 Perception, Fellowship, *or* Agility

**Starting Skills:** Awareness *or* Stealth, Deceive, Linguistics (Low Gothic), Navigate (Surface), and Trade (Cook)

**Starting Talents:** Deadeye Shot, Foresight, Heightened Senses (Sight, Smell, Taste), Sprint

**Starting Traits:** Size (3)

**Abhumans:** Although Cyprian's Gate is home (albeit often temporarily) to nobles and their servants from across the sector, its Imperial Guard regiments are raised exclusively from the indigenous Ratling population. While Cyprian squads might be assigned to work closely with other auxiliaries, such as Tech-Priest Engineers or Ministorum Priests, under exceptional circumstances, such individuals could never really fit in with the Ratlings (even if they wanted to). Cyprian 5th Player Characters cannot be Support Specialists; they can only choose from the Guardsmen Specialities. To include Support Specialists alongside Guardsmen from Cyprian's Gate, players should use the Mixed Regiment rules found in the **ONLY WAR** supplement, **HAMMER OF THE EMPEROR**.

**Narrow Focus:** Due to the restriction on Support Specialists, Cyprian characters have fewer options when selecting a Speciality. However, unlike a lone Ratling operating in a Squad from another regiment, Ratlings fighting alongside others of their own kind often adapt quickly to the traditional roles of their culture on Cyprian's Gate. A Character from this regiment always count as both a Ratling and a Guardsman for the purposes of prerequisites, regardless of his current Speciality or Advanced Speciality.

**Standard Regimental Kit:** 1 Good Craftsmanship long las and 4 charge packs *or* 1 Good Craftsmanship sniper rifle and 4 clips (Main Weapon), 1 stub revolver and 12 bullets, 1 knife, 1 flak vest and flak helmet, 1 chameleoline cloak, 2 frag grenades and 2 smoke grenades, chrono, magnoculars, uniform, poor weather gear, rucksack, basic toolkit, mess kit and water canteen, blanket and sleep bag, rechargeable lamp pack, grooming kit, dog tags, Imperial Infantryman's Uplifting Primer, and 8 weeks' rations (by Ratling standards)

**Favoured Weapons:** Long las, sniper rifle

defend themselves, and launch regular patrols to sweep the forests surrounding their villages and townships. These Ratling huntsmen return with the carcasses of whatever dangerous beasts they find, ensuring both the community's continued safety and a generous feast. The hunters employ long-arms and stealth during these excursions, preferring to bring down their prey from a distance and without being detected. The Ratlings bring these hunting skills from their home world to the Imperial Guard, where their unparalleled skills help them avoid punishment for some of their "indiscretions."

## HISTORY OF CYPRIAN'S GATE

Those who are aware of the history of Cyprian's Gate realise that the enmity between the nobility and the native Ratling population is due to much more than mere clashes of personality and matters of protocol. In fact, many of the world's Ratlings communities continue to harbour a strong dislike of the nobles, whom they view as intruders to this day, due to events early in the history of the sector. The Imperium first rediscovered Cyprian's Gate surprisingly late in the Angevin Crusade, due to the difficulties inherent in traversing the Hazeroth Abyss. When the Crusade fleet did arrive in orbit above the world that would be known as Cyprian's Gate, it discovered a tranquil planet, seemingly untouched by the troubles that had afflicted the region due to its isolation. The native abhuman population lived at a technological level only slightly above that of a typical feudal world, enjoying a largely lackadaisical, agrarian lifestyle. Purity checks conducted by the Adeptus Administratum and the Adeptus Mechanicus, under the watchful eye of the

Inquisition, confirmed the genetic stability of the abhuman population, which was quickly—as least by Administratum standards—classified as *Homo sapiens minimus*.

The nobility of the nascent Calixis Sector quickly claimed Cyprian's Gate as their personal playground, much to the dismay of the native population. As the nobles began to cut down swathes of woodland to construct their pleasure palaces, some of the Ratlings decided to take action. Led by a Caitiff named Ruk Olverpot, a group of rebellious Ratlings conducted a number of raids and acts of sabotage against the construction sites and the nobles' temporary encampments. The band destroyed construction materials, brought down edifices, and thieved supplies. Much to the nobles' shame, their house guards and private militaries were unable to apprehend the culprits, who struck swiftly and covertly, attacking from an unexpected direction each time before withdrawing back to the deep forests. Eventually, Lord Grigory Silverholm, the Administratum-designated prefect—ruling until a permanent

### CREATING THE CYPRIAN HUNTSMEN

The rules listed for the Cyprian 5th light infantry have been created using the Regiment Creation rules included in this chapter and on page 58 of the **ONLY WAR** Core Rulebook.

**Home World:** Ratling World

**Commanding Officer:** Circumspect

**Regiment Type:** Light Infantry

**Doctrines:** Chameleoline, Snipers

**Total Cost:** 12 points



planetary governor could be installed—offered an ultimatum to the native population: deliver Olverpot and his band to justice or be found guilty of aiding and abetting his crimes. As much as it must have pained them to do so, the majority of the Ratling communities saw the futility of Olverpot's resistance, and took steps to deliver him and his freedom fighters into the hands of Silverholm's security forces. Olverpot and many of his supporters were executed for their actions, making them martyrs to the cause. To this day, many Ratling communities hold celebrations in Olverpot's name, despite Imperial crackdowns.

Olverpot's rebellion and the celebrations that continue in his honour are perhaps the most obvious signs of discontent among the seemingly comfortable inhabitants of Cyprian's Gate, but they are not the only ones. Unlike many worlds in the Calyx Expanse, Cyprian's Gate had survived its long period of isolation in peace and relative prosperity. And while the majority of Ratlings on Cyprian's Gate recognize the importance of the Imperium and its divine right to rule the galaxy in the Emperor's holy name, there are those who question the demands which the Imperium places on them. After all, some say, after a few pints of ale and out of earshot of the tall off-world nobles, the Ratlings had gotten on just fine before the Angevin Crusade. Amongst the most isolated communities, some Ratlings still prefer to stick to the old ways, quietly resenting the Imperial Tithe, their sons and daughters forced to fight and die in distant wars for someone else's cause.

## TRAINING AND EQUIPMENT

To take full advantage of their naturally small size, light feet, and quick reflexes, regiments raised from Cyprian's Gate are most often trained and equipped as snipers. Cyprian's Gate has never produced an armoured or mechanised regiment. Not only does the planet's relatively low technological and industrialisation level preclude this, but standard Imperial vehicles are not built to accommodate Ratlings, and considerable modification would be necessary. Further, such equipment would be a waste of the Ratlings' natural talents and potential (although it would compensate for their less-than-hearty physiques). The Cyprians' small size and relative lack of physical strength or resilience leave them ill-suited for work as line infantry regiments, and most are classified as either light infantry or reconnaissance. In either case, the training and equipment are often similar or identical. Armed with long lases or sniper rifles and swathed in chameololine cloaks, the Cyprian regiments supplement their tracking and hunting skills with additional training under seasoned Imperial Guard veterans.

Most Cyprian regiments' uniforms consist of neutral or camouflage tones of browns and greens, with a specially sized flak vest of the same colours, and a flak helmet with flaps to protect the Ratlings' sensitive ears from the sounds of their weapons' discharge. Alongside their long arm, most Cyprian's Gate regiments include a sidearm, and many prefer a basic slug thrower over a laspistol, as it more closely resembles the traditional weapons of their home world.

## RELATIONS WITH OTHER REGIMENTS

As one might expect of Ratlings, the abhumans of the Cyprian's Gate regiments are almost universally friendly and outgoing. Those harbouring prejudice against the diminutive abhumans are quick to say that this friendly nature is merely a ploy to earn others' trust and wrong-foot them so that the Ratlings can help themselves to pockets, larders, coffers, and anything else their sticky little fingers favour. There might, perhaps, be some truth in this, but only because the Ratlings of Cyprian's Gate do not make the same judgement on such matters that ordinary humans might. There is nothing malicious about a little theft between friends, and the sentiments of good will are earnest—they see no contradiction between the two.

Incidents of theft aside, most regiments are happy to work alongside those of Cyprian's Gate. On the field of battle, the Ratlings' skills in stealth and sniping have proven invaluable time and again. On the world of Sisk, a Cyprian trooper named Horlo Nabbit saved the 3rd platoon of the Brontian 91st from almost certain damnation when he took down a rampaging rogue psyker with a shot from his long las. Through many such incidents, including the delivery of valuable intelligence from advance scouting, or the assassination of dangerous enemies, the troopers of the Cyprian regiments have saved lives and won battles. Rarely, however, are they recognised for their valour—the medals and commendations almost invariably go to more visible troopers and officers.

As well as their value in battle, the Ratlings of Cyprian's Gate often provide a tangible boost to the morale of those regiments with which they serve. This is primarily attributable to the comestibles they provide through official or unofficial service in

the galleys, as well as other recreational activities and goods they offer purely off the books. From non-standard issue weaponry, to lho-sticks and, in some cases, obscura and other illicit goods, each Cyprian regiment is certain to have at least one prolific black marketeer amongst its number, as well as many more who dabble in the business. That so few Ratlings are ever caught by the Commissars or otherwise sanctioned for their actions speaks volumes of their skill in stealth and subterfuge.

## CYPRIAN HUNTSMEN IN THE SPINWARD FRONT

To date, two regiments of Cyprian Huntsmen have been deployed in the Spinward Front: the Cyprian 5th light infantry and 9th reconnaissance regiments, under the command of Colonel Griff MacHuffin and Caitiff-Commander Horzo Grompken, respectively. As is customary with specialised abhuman regiments, the Departmento Munitorum has divided both regiments into their constituent parts, seconding individual companies or even squads to reinforce other regiments. Cyprian soldiers have fought alongside regiments such as the Catachan 344th, Krieg 99th, Hredrin 32nd, and Cadian 301st. In all cases, the Cyprians' abilities at stealth and marksmanship have proved invaluable to commanders, supplementing the capabilities of their own soldiers.

For many of the citizens of Cyprian's Gate, leaving their home world to fight in the Imperial Guard is a rude awakening. Transitioning from an Administratum-classified pleasure world to the hellish warzones of the Spinward Front is a hellish proposition, and the Cyprian regiments have experienced significant morale problems, including a small number of desertions. These incidents have cast a pall on the otherwise commendable service of the Cyprian Ratlings.

## THE CYPRIAN 5TH LIGHT INFANTRY "EAGLE-EYES"

The Cyprian 5th light infantry is one of two regiments from Cyprian's Gate currently embroiled in the war for the Spinward Front. The 5th Cyprian Light Infantry earned their moniker of "Eagle-Eyes" for their unerring accuracy with rifles, but the more religious amongst their number also take the name as a sign of the Emperor's favour.

While Colonel Griff MacHuffin is ostensibly the regiment's commanding officer, in reality he rarely receives the opportunity to command more than a squad or two at a time, as the general staff divide the regiment and spread its component parts across the Front to supply their skills where they are most needed.

This seems to suit the modest Colonel fine, for the most part.

MacHuffin is used to the "big folks" underestimating him and his kind, and so long as his men receive recognition for their abilities, he does not overly mind his abilities as an officer being under-utilised. MacHuffin offers his counsel to the officers of whatever regiment he is stationed alongside, most recently the Valhallan 405th.

Due to the unique nature of an abhuman regiment, each squad of the Cyprian 5th must be capable of operating independently of its own command structure yet under the direction of other officers. Most sergeants of the 5th Light Infantry have learned to interpret their orders cautiously, as most officers of the regiments to which they are assigned see the Ratlings as more of a resource, putting even less consideration in their safety than they do their own men. Since their duties as forward ranging snipers often leave them relatively isolated from the rest of the regiment they are seconded to, the Huntsmen are able to operate with some leeway when implementing their orders. Generally, they are effective enough that this does not cause problems. In some cases, however, the officers of their adopted regiment take some offence at this attitude, subsequently assigning the Huntsmen squad or squads to even more dangerous tasks.

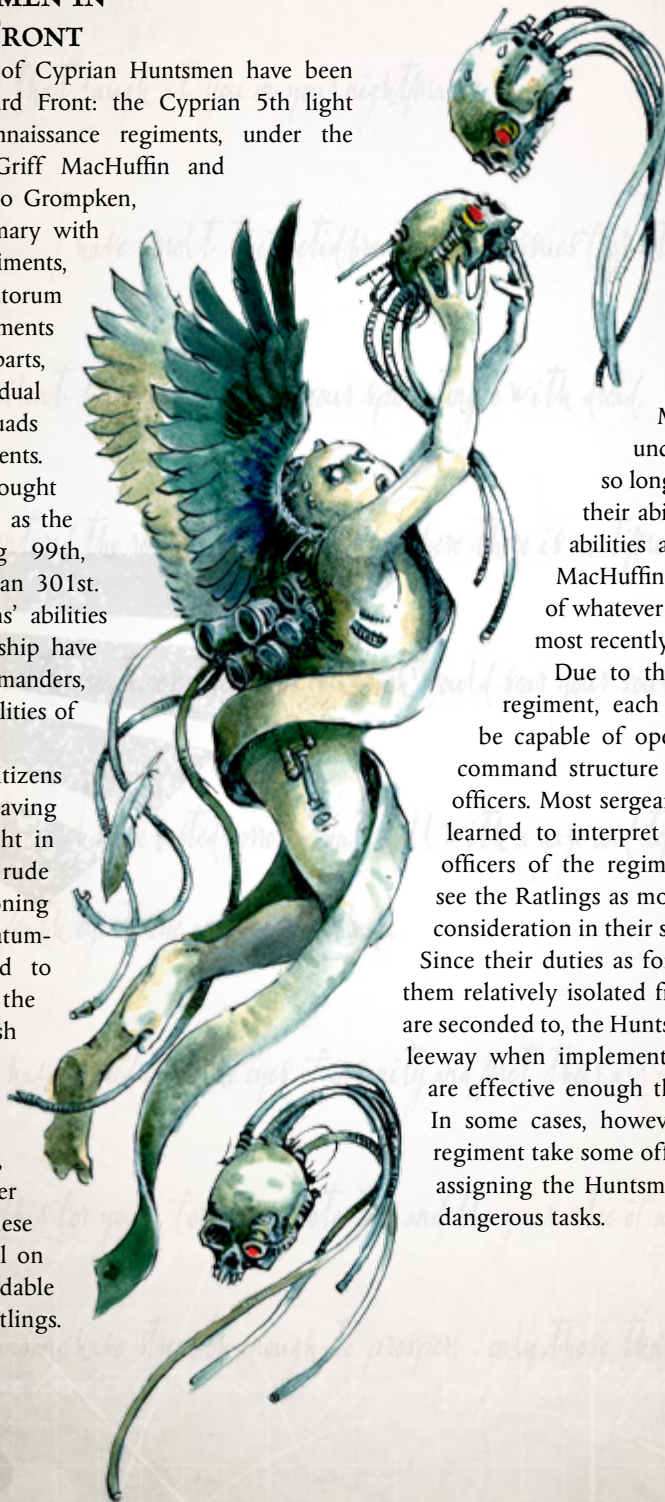

I: DEFENDERS OF THE IMPERIUM

# THE ORCAN STONECRUSHERS

*"Emperor want us fight, so we fight. Krup want make Emperor happy."*

—Krup, Bone 'ead of the Orcan 97th, 3rd platoon, 1st squad

In the wake of the Angevin Crusade, the colonists and Administratum tithe assayers swept through the newly conquered worlds of the nascent Calixis Sector, cataloguing planets and determining their usefulness to the Imperium. The world designated Orcus was found to be unsuitable for colonisation due to its high gravity, yet, paradoxically, was already inhabited. Administratum census proctori and Adeptus Mechanicus genetors confirmed within one year that the human-descended denizens of Orcus were stable abhumans, classifying them as Ogryns. The representatives of the Priesthood of Earth began the task of bringing Orcus into the Imperial fold. He classified the planet, its native flora and fauna, and its abhuman inhabitants; but it would be many years before the Administratum found an appropriate purpose for the inhospitable world.

Orcus is a largely barren world of rocky crags and plateaus. The native animal life tends toward the large and dangerous, while the flora consists primarily of hardy grasses and mosses. Saltwater oceans cover approximately a quarter of Orcus's surface, fed by freshwater streams that flow from the craggy mountain peaks. Orcus' native inhabitants primarily live on the equatorial region's rocky highlands and lowland planes, although smaller communities can be found in the mountains and even wandering the frozen tundra of its poles. The native Ogryns are hearty enough to survive almost anywhere on the world's surface. The Ogryn inhabitants of Orcus live a primarily hunter-gatherer lifestyle, following the herds of gonar beasts in their migrations across the plains. The tumbled and ruined remains of ancient colony complexes are largely buried beneath

millennia of earth and growth and, though the native Ogryns claim that the ruins have always been there, the clear semblance to STC patterns indicates that these structures were the abodes of the Ogryns forebears. However, by the time of the Angevin Crusade, the Ogryns' technology level was profoundly primitive, with most groups lacking even the knowledge to forge basic metals. Stone or bone weapons dominated, and what few trees grew on Orcus were made into massive spears for hunting the great beasts of the plains. Even if the Ogryns had the mental capacity to utilise the surviving equipment of their ancestors, their oversized and clumsy fingers could hardly manipulate it.

Despite a few initial incidents, the majority of the native Ogryn population welcomed the Imperium, not unlike the way a child might enthusiastically welcome a returning parent. The Missionaria Galaxia introduced the Imperial Creed to the population far more quickly than they expected, as the Ogryns wholeheartedly embraced the worship of the Emperor. It soon became apparent that the Ogryns craved the Emperor's approval, interpreting his status as the Father of Mankind quite literally. The gargantuan inhabitants

of Orcus flocked to hear the word of the Ministorum priests, hanging on their every word, though failing to comprehend many of them. Despite such success, throughout this initial contact the world's crushing gravity was a constant problem for the Imperium's agents and Adepts. Consequently, much of the work of assimilation and governing had to be done from orbiting spacecraft, and later from permanent orbital facilities. Those devoted missionaries and priests who proselytised to the Ogryns could endure only brief periods on the surface, returning frequently to the ships and void stations in orbit, much to the Ogryns' disappointment.

In 609.M40, the Adeptus Administratum found a use for Orcus. With its high gravity acting as both a natural form of restraint and unusual punishment, the Adepts decreed that Orcus would serve as a penal world. Immediately, construction began on massive penitentiary complexes—much to the bemusement of the natives—and Adepts of the Administratum



## REGIMENT RULES

Characters belonging to the Orcusian 97th gain the following advantages:

**Characteristic Modifiers:** +3 Weapon Skill, +10 Strength, +10 Toughness, -18 Intelligence, -10 Agility, and an additional +3 to either Strength *or* Toughness

**Starting Skills:** Intimidate, Survival, Dodge *or* Parry

**Starting Talents:** Die Hard, Iron Jaw, Lightning Reflexes

**Starting Traits:** Auto-Stabilised, Size (5), Sturdy, Unnatural Strength (+2), and Unnatural Toughness (+2) Traits, as well as the Clumsy and But it Dark in Dere! Traits (see page 91 of the **ONLY WAR** Core Rulebook)

**Fluency:** Though they are likely to speak a debased version of their ancestral language, or else learn to upon their induction into the Imperial Guard, Ogryn world characters lack the intellectual capacity to learn how to read or write the universal language of the Imperium. Because of this, Ogryn world characters do not start with the Linguistics (Low Gothic) Skill at creation. They are still capable of engaging in any verbal communication in Low Gothic that does not require a Skill Test. However, even Ogryns who have undergone Bone 'ead surgery still speak and comprehend slowly, and verbal communication with humans who lack experience dealing with Ogryns is prone to some difficulty, at least until they come to an understanding of the Ogryns' primitive use of the language.

**Abhumans:** While Orcus is home to ordinary humans, these individuals are either members of the Adeptus Arbites, and therefore precluded from service in the Imperial Guard, or the very prisoners to which the native Ogryn population have acted as gaolers for centuries, which would be represented by the Penal Colony origin. While it is common for Ministorum Priests and Commissars to accompany the Orcusian 97th on the field to keep them on-task and directed, such individuals stand distinctly apart from their charges, for obvious reasons. Therefore, Orcusian 97th characters cannot be Support Specialists; they can only choose from the Guardsmen Specialities. To include Support Specialists alongside Guardsmen from the Orcusian 97th, players should use the Mixed Regiment rules found in the **ONLY WAR** supplement, **HAMMER OF THE EMPEROR**.

**Narrow Focus:** Due to the restriction on Support Specialists, Orcusian characters have fewer options when selecting a Speciality. However, unlike a lone Ogryn operating with a Squad from another regiment, Ogryns fighting alongside others of their own kind often more quickly adapt to the traditional roles of their culture (such as it is) on Orcus. A Character from this regiment always count as both an Ogryn and a Guardsman for the purposes of prerequisites, regardless of his current Speciality or Advanced Speciality.

**Wounds:** Characters of the Orcusian 97th gain +15 starting Wounds.

**Standard Regimental Kit:** 1 ripper gun and 4 clips, 1 suit of Best Craftsmanship Imperial Guard flak armour, 5 frag grenades, 1 mono-great weapon, uniform, poor weather gear, rucksack, basic toolkit, mess kit and water canteen, blanket and sleep bag, rechargeable lamp pack, grooming kit, dog tags, Imperial Infantryman's Uplifting Primer, and 6 weeks' rations

**Favoured Weapons:** Ripper gun, autocannon

and Adeptus Arbites began drafting the native Ogryns to work as guards and custodians. The crushing gravity ensures that ordinary humans can tolerate only short spans on the world's surface, and so the Arbitrators who manage the penal world cycle through brief rotations on-planet, with the rest of their time spent aboard Orcus' two orbital stations, situated in geosynchronous orbit above each pole. During their terms on-world, the Arbitrators act primarily in a supervisory capacity, leaving the day-to-day guard duties to the Ogryn custodians, whom they often refer to as "guard dogs", or similar derogatory terms. Yet most insults go unnoticed by the Ogryns, who are happy to serve in any capacity, as long as they believe it is the Emperor's will.

## TRAINING AND EQUIPMENT

Orcan regiments have an advantage over many forces raised from other Ogryn worlds due to the training that many of them undergo to serve as guards of the penitentiary complexes. These Ogryns have experience following orders, however limited and simplistic they might be, which is valuable to the Imperial Guard. Because of this, Orcan regiments have a reputation for being somewhat easier to work with than other

Ogryn forces. With many of them having already reached the limits of their mental capacity, Ogryns raised from Orcus often undergo even less training than other Ogryn regiments, which is to say practically none at all.

Orcan regiments are equipped with extremely heavy and thick flak armour incorporating numerous rigid plates. While still basic and simple to produce, this armour provides greater protection than typical models of Imperial Guard flak armour, enhancing the Ogryns' already considerable resilience. As with nearly all Ogryn regiments, the standard-issue weapon of the

### CREATING THE ORCUSIAN 97TH STONECRUSHERS

The rules listed for the Orcusian 97th have been created using the Regiment Creation rules included in this chapter and on page 58 of the **ONLY WAR** Core Rulebook.

**Home World:** Ogryn world

**Commanding Officer:** Sanguine

**Regiment Type:** Close Assault Regiment

**Doctrines:** Ogryn Weapons

**Total Cost:** 11 points

I: DEFENDERS OF  
THE IMPERIUM

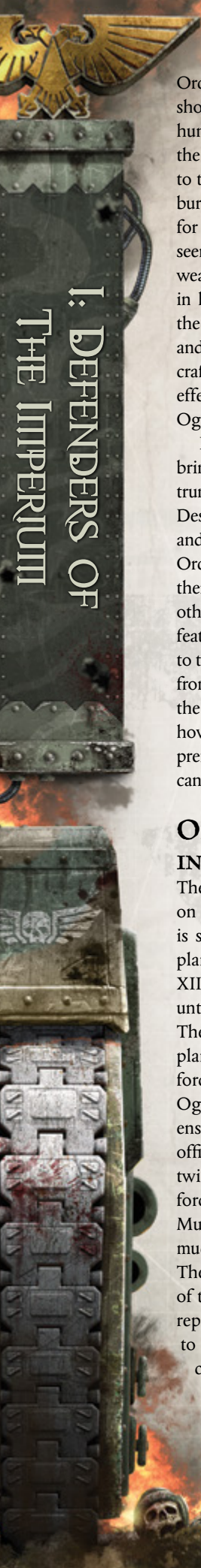

Orcan regiments is the ripper gun, a massive automatic combat shotgun, far too large and unwieldy for use by a normal human. While the recoil alone could tear a man's arms from the sockets, the Ogryns of Orcus seem completely oblivious to the kick, happily blasting away at their foes with burst after burst of fire. Drawing on their primitive instincts and talent for brutal melee combat, the Departmento Munitorum has also seen fit to grant many Orcan regiments with additional melee weapons. While ripper guns are built to withstand use as clubs in hand-to-hand combat, many Orcans prefer weapons with the feel and effect of the crude stone great-axes, hammers, and mauls of their home world. Similarly, simplistic weapons crafted of more advanced materials are significantly more effective in battle, and their shiny surfaces seem to please the Ogryns greatly.

In addition to their Munitorum-issue kit, many Orcans bring primitive weapons from their home, or the heavy-duty truncheons issued by the Adeptus Arbites for their gaoler duties. Despite the orders of their superiors in the Imperial Guard and even the Commissars, whom the Ogryns adore, many Orcan regiments practice barbaric rituals that are common in their society, from taking the skulls of their slain enemies or other such grisly trophies, to loud and raucous celebrations featuring their traditional "music." Such issues are not unique to the Orcan regiments, and are common with regiments raised from feral worlds. Such activities are less common amongst the Ogryns who have served as guards for the penitentiaries, however—yet another reason the Departmento Munitorum prefers to recruit such individuals to the greatest extent they can negotiate with the Adeptus Arbites.

## ORCAN STONECRUSHERS IN THE SPINWARD FRONT

The Orcan regiments have something of a unique position on the Spinward Front, owing to their recent history. Orcus is situated firmly with the Periphery, and was amongst the planets claimed by the Severan Dominate when Duke Severus XIII declared his secession. For many months, this meant little, until the "liberation forces" of the Severan Dominate arrived. The miniscule contingent of Adeptus Arbites stationed on the planet were completely unprepared to hold off the invading force. Their chances might have been better with the native Ogryns' assistance, but the Ducal Legates reached them first, ensuring such aid would not come. The Duke's own political officers quickly swayed the loyal Ogryns to their cause, twisting the abhumans' devotion to the Emperor, just as the forces of the Severan Dominate did on many other worlds. Much to the Severan Dominate's satisfaction, this act proved much easier with the simple-minded and trusting Ogryns. The Ducal Legates succeeded in convincing a large number of the Ogryns, including chieftains and Bone 'eads, that they represented the will of the Emperor, and that obedience to Duke Severus would please Him on Earth. Wisely and correctly concluding that the small presence of Ministorum

Priests stationed within the penitentiary complex would pose the greatest obstacle to the conversion of the Ogryns, the Duke's forces struck at the representatives of the Ecclesiarchy swiftly, despatching special

operations units to silence them. This being done, the Severan Dominate's wordsmiths continued their mission to recruit the dim-witted Orcans to the Duke's cause. With the aid of the native Ogryns, the Severan Dominate quickly took control of Orcus.

By the time Imperial reinforcements arrived in the form of the Brontian 23rd Light Infantry, with artillery support from the 203rd Krieg, Orcus was firmly in the hands of the Severan Dominate, who had begun recruiting Imperial convicts and recidivists of all stripes to their cause. Many of these individuals, already resentful of the Imperium, took little convincing to swear to the Duke's service. Still more gladly pledged their service in exchange for freedom from the penitentiaries. Though this caused some concern for the native Ogryns, who had been taught for centuries to despise the prisoners as enemies of the Emperor, it was not enough to sway them from fighting alongside the Duke's forces to repel the Imperial relief. With the high-gravity conditions of Orcus, both the Severan Dominate and Imperial forces fought at a huge disadvantage, leaving the Ogryns as the deciding factor in battle.

With so many Ogryns bolstering their numbers, the Severan Dominate decisively won battle after battle. The turning point came when a number of Adeptus Ministorum priests took to the field, hoping to rally the Brontian forces for a renewed counter attack. Recognising the preachers as representatives of the Emperor's will, the Ogryn forces faltered when they saw the scions of the emperor's word about to be slaughtered. Their leader, Brik Agrak, switched sides once more and rushed to the preachers' aid, barrelling into the Severan Dominate infantry, swiftly followed by his Ogryn warriors. In the confusion, it was only thanks to Brik's Bone 'ead surgery, required for his duty as a pen-block supervisor, that a battlefield alliance was possible. Loudly affirming the Ogryns' loyalty and devotion to the Emperor, Brik parleyed with the Ministorum detachment and quickly rallied the other (rather confused) Ogryns to redirect their attacks against the Severan Dominate forces.

With Brik's assistance, the Imperial Guard soon rallied the rest of the local population to the Imperial cause. As word of the Severan Dominate's treachery spread throughout the Ogryn population, they rose up and retook their world alongside the Imperial forces. The victory took many months, but with the Ogryns against them, the Severan Dominate lacked the manpower to hold their territory. With previously unseen fury, the Ogryns decimated the Severan Dominate that had deceived them into betraying the Imperium.

In the aftermath of the retaking of Orcus, the Departmento Munitorum was understandably wary of the Orcan Ogryns. However, even during the Duke's control of Orcus and the natives' misguided allegiance to him, Orcan forces had continued to serve the Imperial Guard loyally in the Jericho Reach, Scarus Sector, and even in the Spinward Front. The Orcan regiments fought valiantly against the forces of the Severan Dominate, even while their brethren at home were swayed to the Duke's cause. Weighing all factors, the masters of the Departmento Munitorum saw fit to raise several additional regiments from Orcus, once the pacification was all-but-complete. The general staff



immediately pit these new regiments against the Severan Dominate on a half-dozen worlds, with Commissars assigned to directly supervise their activities. Surely enough, the newly recruited Orcans fought ferociously against the Severan Dominate forces, driven by rage at the traitors and an overwhelming desire to redeem themselves in the eyes of the Imperium and the Emperor.

Recently, officers of the Departmento Munitorum have made the controversial recommendation to raise a penal regiment from amongst Orcus's imprisoned criminal population. With the ever-increasing need for personnel in the Spinward Front, this action is proceeding, and a new Orcan regiment of a very different kind is soon to be amongst the Imperial Guard forces fighting against the enemies of the Imperium on the Calixis Sector's border.

## THE ORCAN 97TH STONECRUSHERS

Like nearly all Ogryn regiments, both those raised from Orcus and elsewhere, the Orcan 97th is an infantry regiment that specialises in shock tactics and close-quarters warfare. Clad in heavy-duty flak armour and wielding a combination of robust ripper guns and heavyweight melee weapons machined for the hulking abhumans, the Ogryns of the 97th are a terror to behold in combat. Charging through hails of enemy fire without regard to their safety, the Ogryns close with their enemies in order to annihilate them in the brutal swirl of melee combat. Typically, the warriors begin firing their ripper

guns upon sight of the enemy, whether or not they are within effective range, and cease firing only once engaged in melee or they run out of ammunition. Due to Ogryns' intense fear of enclosed spaces, the squads do without Chimeras or other armoured transport, instead closing on foot. Because of this, the Ogryns are frequently assigned to battle zones with dense terrain and an abundance of close-range engagements. However, out of necessity, arrogance, or incompetence, Orcan 97th squads are not infrequently assigned to warzones where they must cross no-man's-land or other open terrain in order to engage the enemy up-close. Fortunately, the Ogryns' robust physiques and heavy armour include that only the most dedicated enemy fire has a chance of stopping them before they charge into the foe's ranks.

On paper, the highest ranked member of the Orcan 97th, and by default its commanding officer, is Bone 'ead 1st class Yurp Clandek. However, even the most intelligent of Ogryns is unfit to lead any organisational unit larger than a single squad. Because the Orcan 97th, as most Ogryn regiments, is divided up and spread across numerous fronts, where individual platoons or squads are seconded to other regiments or formations, the question of commanding officer is a moot point. In practice, the abhumans of the Orcan 97th are at the command of whatever officer leads the force to which they are assigned. Lacking any sort of grasp of strategy above that of an ordinary human child, Clandek is completely incapable of coordinating efforts across the vast distances between squads, even were he to possess an understanding of the logistics of long-range communication. Consequently, once split away, Orcan 97th squads are completely isolated from the rest of their regiment, often permanently. In cases where squads of the 97th serve long-term with a particular regiment, they sometimes adopt certain elements of that regiment. However, adaptation is not a strong point for the Ogryns, and most squads of the Orcan 97th remain unchanged, regardless of the time elapsed since they last saw others of their kind.

The Orcan 97th is one of the regiments raised in the aftermath of the Imperium's retaking of Orcus from the Severan Dominate. Consequently, its squads are almost invariably watched closely by Commissars, who frequently even accompany the squad into battle. These Commissars refrain from integrating too closely with their charges, both due to the unsavoury nature of the Orcans' personal hygiene and other personal customs, and so as to remain wary for any signs of lingering treachery. For their part, the Orcan 97th crave the approval of the Commissars and other representatives of the Imperium, desiring only to prove their loyalty to the Emperor. To this end, they fight bravely and ferociously against the traitors of the Severan Dominate, and strive to follow orders to the letter—no matter how confusing the instructions might be to the dim-witted, yet well-intentioned Ogryns.

# THE CRIMSON GUARD

*"The enemy outnumber us approximately five to one. Based on available data I estimate our likelihood of victory at 96.7%."*

—Venatorius Decani Solus Excarn,  
before the Third Battle of Jankyr Field

In the wake of the so-called War of Brass from 738 to 740.M41, the Skitarii legions of the Calixis Sector were in tatters, leaving the notoriously independent Lathe Worlds without a reliable defence force. It was at this time that the leaders of the Adeptus Mechanicus Calixis began discretely building a new fighting force, its original members drawn from military-minded Tech-Priests from across the sector. The force that would one day be known as the Crimson Guard was centuries in the making, built in secrecy at installations hidden across the Adeptus Mechanicus's holdings. The end result was an elite force dubbed the Venatorii, which would remain separate from the still-recovering Skitarii legions, even once they resumed their full capacity.

The Crimson Guard, known for their red carapace armour and robes, are elite even in comparison to the Skitarii. Heavily augmented and endowed with the same unique implants that mark out all members of the Tech-Priesthood, albeit enhanced for combat purposes, the Venatorii are nothing less than an elite formation of militant Tech-Priests. Each member of the Crimson Guard is clad in sophisticated and lightweight carapace armour, forged under the unique gravity conditions of the Lathe Worlds. Perhaps the most distinguishing aspect of the Venatorii's equipment is the use of integrated weapons—rare patterns of energy weaponry that draw their power and ammunition directly from the user's potentia coil. In addition to the benefit of never needing to reload or running out of ammunition, these weapons are built to

the specifications of ancient designs dredged from the deepest data-crypts of the Lathe Worlds, and are potent beyond anything the Adeptus Mechanicus crafts for the Departmento Munitorum. Certainly, any Imperial Guard who fight alongside the Venatorii must stand in awe of the firepower each Crimson Guard wields. Of course, those Guardsmen also know better than to question the mysterious tech-rites of the Adeptus Mechanicus.

## TRAINING AND EQUIPMENT

Even for those Guardsmen whom they fight alongside, the Venatorii present a frightening aspect. Their crimson and black armour is all-enclosing, with the exception in some cases of certain robust cybernetic parts that need no additional protection. Never, however, is any mote of weak flesh visible on a Crimson Guard soldier. Thus, even before seeing them in battle, the Imperial Guard regiments stationed alongside the Venatorii are wary of the Crimson Guard, who seem as something other than human. And indeed, this is true, for the Venatorii



## REGIMENT RULES

Characters belonging to the Crimson Guard gain the following advantages:

**Characteristic Modifiers:** +3 Ballistic Skill, +3 Intelligence, +3 Perception *or* Ballistic Skill, –3 Strength.

**Starting Skills:** Common Lore (Adeptus Mechanicus), Common Lore (Tech), Linguistics (Low Gothic, Techna-Lingua), Logic, Operate (Surface), Tech-Use

**Starting Talents:** Paranoia, Resistance (Fear)

**Starting Aptitude:** Tech

**The True Flesh:** Lathe Worlds characters possess the Mechanicus Implants Trait. In addition, their potentia coil is specifically enhanced to meet the high energy needs of Integrated Weapons.

**Isolated by Machines:** Lathe Worlds characters are selected for a life of war at a young age, dedicating their lives to the defence of the Adeptus Mechanicus' interests in the Calixis Sector. The warriors of the Crimson Guard and other Lathe Worlds forces are unforgiving, blunt, and come across as quite harsh to those unfamiliar with the cold, logical way the Adeptus Mechanicus operates. Lathe Worlds characters often relate to machines and servitors more readily than their flesh and blood counterparts, and have a tendency toward jargon and filling their conversations with long strings of Techna-Lingua that are nearly unintelligible to the average trooper. These characters suffer a –10 penalty to any Interaction Tests made to interact with characters who are not also from a Lathe World, forge world, or are initiates of the Adeptus Mechanicus.

**Soldiers of the Ommissiah:** The Lathe Worlds Home World represents a uniquely specific origin for a regiment. Such forces are not truly Imperial Guard regiments at all, and so do not include the Support Specialists associated with Imperial Guard regiments. Lathe Worlds characters cannot select the Commissar, Ministorum Priest, Ogryn, Ratling, Sanctioned Psyker, or Storm Trooper Specialities (they can select the Tech-Priest Enginseer Speciality). A Character from this regiment always count as both a Tech-Priest Enginseer and a Guardsman for the purposes of prerequisites, regardless of his current Speciality or Advanced Speciality. If a group wishes to include Support Specialists other than Tech-Priest Enginseers in a Lathe Worlds Squad, players should use the rules for Mixed Regiments presented in the **ONLY WAR** supplement, **HAMMER OF THE EMPEROR**.

**Disciples of the Machine God:** Though both serve the Imperium, and the Adeptus Mechanicus are commonly believed to worship the Emperor in his aspect of the Ommissiah, the religious beliefs of the Tech-Priesthood and Ecclesiarchy are fundamentally incompatible on closer inspection. Consequently, the Ecclesiarchy views the Crimson Guard with suspicion, seeing their worship of the Machine God as dangerously iconoclastic. Characters from this regiment suffer a –10 penalty to all Interaction Tests with the representatives of the Ecclesiarchy (this is cumulative with the interaction penalty for the Isolated by Machines rule, above). Should the masters of the Crimson Guard see fit to station them alongside Imperial Guard forces that include Adeptus Ministorum Priests, those auxiliaries are sure to experience problems dealing with the regiment. Player Characters with the Ministorum Priest Speciality suffer a –10 penalty when interacting with NPC members of this regiment, including Comrades, but excluding the Ministorum Priest's own Comrade (it is assumed that his Comrade is also not a member of the Crimson Guard). At his discretion, the GM might additionally apply this penalty to other PCs with ties to the Ecclesiarchy.

**Wounds:** Crimson Guard characters generate their Starting Wounds normally.

**Standard Regimental Kit:** Integrated Lathe-lasrifle, venator blade, Crimson Armour, two Common Craftsmanship cybernetics *or* one Good Craftsmanship cybernetic, red Mechanicus robes (uniform), poor weather gear, rucksack, anointed toolkit, mess kit and water canteen, blanket and sleep bag, rechargeable lamp pack, cognomen, and 2 weeks' rations per Player Character, and one Bane Wolf per Squad

**Favoured Weapons:** Integrated weapons

undergo such training and extensive augmentation as to often leave them more machine than man, in mind and body. After witnessing the Venatorii on the field of battle, most Guardsmen only affirm their fear of the mysterious red-shrouded warriors, for the Crimson Guard are utterly merciless, cutting down enemies with barrages of high-intensity energy beams and taking no prisoners.

Upon the Lathe Worlds, nothing short of perfection is good enough, be that for their technological marvels or the conditioning of their troops. The Venatorii, however, are first among these "perfect" warriors. Training for a soldier of the Crimson Guard takes decades. Of course, during this time the aspirant undergoes significant cybernetic enhancement, as well as rigorous training in matters of combat, military

strategy, and techno-theology. After this period, the newly made Venatorius is ready to join the lowest ranks of the Crimson Guard. As the soldiers of the Crimson Guard rise in experience and rank, they almost invariably gain additional cybernetic implants and replacements, as do all Tech-Priests. In the case of the Venatorii, these augmentations are made to enhance the bearer's combat potential. For Venatorii officers, of course, this often includes enhancements to their cognitive abilities. Experienced Venatorii utilise all manner of arcane and rare technology, including Alatus-pattern jump packs, Het-pattern targeters, graviton weapons, and more.

I: DEFENDERS OF  
THE IMPERIUM

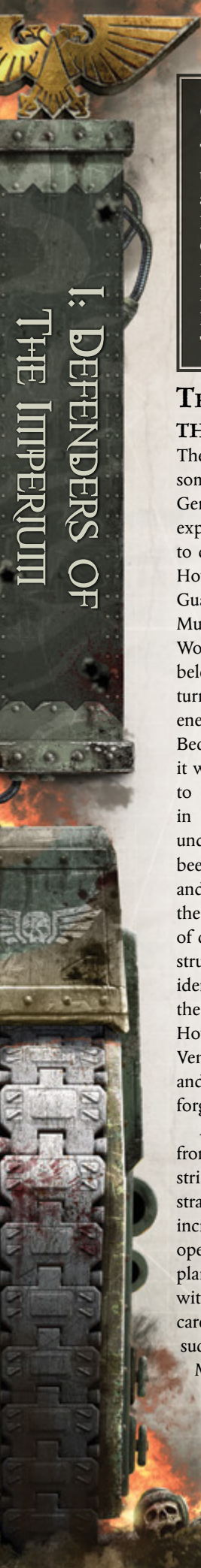

## CREATING THE CRIMSON GUARD

The rules listed for the Crimson Guard have been created using the Regiment Creation rules included in this chapter and on page 58 of the **ONLY WAR** Core Rulebook.

**Home World:** The Lathe Worlds

**Commanding Officer:** Bilious

**Regiment Type:** Hunter-Killer

**Doctrines:** Cyber-Enhanced, Defenders of the Omnissiah

**Drawback:** Iconoclast

**Total Cost:** 12 points

## THE CRIMSON GUARD IN THE SPINWARD FRONT

The presence of the Crimson Guard in the Spinward Front is something of a mystery, even to those highly placed on the General Staff. Whether their aid was requested or not, few expected the notoriously insular masters of the Lathe Worlds to commit their own elite Crimson Guard to the campaign. However, the Crimson Guard are not soldiers of the Imperial Guard and do not take their orders from the *Departemento Munitorum*, except where it aligns with the goals of the Lathe Worlds. Oft times, Crimson Guard forces appear to relieve a beleaguered Imperial Guard force with little or no warning, turning the tide and pressing the attack back against the enemy, or withdrawing suddenly once the battle is concluded. Because the *Adeptus Mechanicus* shares only the information it wishes with the *Departemento Munitorum*, it is impossible to gauge the full extent of the Crimson Guard presence in the Spinward Front. Barring any clandestine missions undertaken without Imperial Guard support, Venatorii have been involved in combat on no fewer than a dozen worlds and warzones. Differences in the equipment and operation of the forces point to at least five unique Venatorii forces, but of course the Crimson Guard are not bound by the regiment structure of the Imperial Guard. Tech-Priest Engineers have identified at least three different Lathe Worlds amongst the Venatorii forces on Kulth and in the Karacallia system. However, even to their brethren amongst the Engineers, the Venatorii remain aloof and mysterious, for they are an elite and secret force, insular toward all those not of their own forge world of origin.

As well as reinforcing Imperial forces on a number of fronts, the Crimson Guard have made a number of surgical strikes against enemy installations with no recourse to the strategic plans of the General Staff. In the case of particular incidents on Horizon, Hervara, and Ganf Magna, such operations came close to catastrophically interfering in the plans of Imperial Guard commanders, leading to some tension with *Mechanicus* forces. However, the *Adeptus Mechanicus* care not for the concerns of the Imperial Guard, leaving such tensions to simmer. Unknown to the *Departemento Munitorum* is the fact that the Crimson Guard often operate under mysterious orders from the masters of the Lathe Worlds, failing even to coordinate with other *Adeptus Mechanicus* forces in the theatre.

## THE LATHE-HADD 10TH VENATORII MANIPLE

The 10th Venatorii maniple of Lathe-Hadd has been one of the more active Crimson Guard forces in the Spinward Front to date, with operations on Kulth, Thrax, Kalf, Hervara, and others, including a mysterious operation to the forbidden world of Sickle. This last is exemplary of the independence of the Crimson Guard from the *Departemento Munitorum* strategic command and even from other *Adeptus Mechanicus* forces. While the 10th Lathe-Hadd Venatorii maniple has engaged in numerous battles alongside the forces of the Imperial Guard, it is clear that the masters of Lathe-Hadd have their own reasons for despatching the Crimson Guard to the Spinward Front.

For those aware of Lathe-Hadd's current situation of low production and internal strife, the fact that "the Silent Forge," as some know it, would despatch a sizeable force to the Spinward Front is quite a surprise. For centuries, Lathe-Hadd has been overshadowed by its brethren Het and Hesh. This situation has, ironically, been exacerbated in recent times by the decision to move the world's extensive ammunition-manufacturing facilities off-world in order to leave room for loftier projects that never materialised. In present days, the Tech-Priests of Hadd are divided into numerous factions, squabbling and back-stabbing in attempts to elevate their projects over that of their rivals. It is in this environment that Forge Master Wahh, the highest-ranking Magos of the forge world, despatched the 10th maniple to the Spinward Front. To some, it appears that this is simply another attempt to recapture the forge world's former glory through victory in battle. Others believe that Wahh seeks a different sort of glory amidst the worlds of the Spinward Front, and some whisper that the ruler of Lathe-Hadd believes a technological artefact of profound significance lies hidden amidst the worlds currently embroiled in war—an artefact he hopes to secure for himself before either the Severan Dominate or his *Adeptus Mechanicus* rivals within the Calixis Sector uncover it. None can say what this artefact might be, though rumours speak of a potent STC or an ancient weapon of apocalyptic power.

## SECRETS OF THE MECHANICUS

GMs and players planning to integrate the Crimson Guard into their **ONLY WAR** campaign can find a wealth of information of the Venatorii's history in the Dark Heresy supplement *The Lathe Worlds*. This information is not necessary to play members of a Crimson Guard regiment, but the additional background information can greatly enhance such a game. Additionally, history and current events of the Lathe Worlds can be used in any campaign with a focus on the *Adeptus Mechanicus*. After all, it is certain that the Lords Dragon of the Lathe Worlds have their gaze upon the events unfolding on the Spinward Front.

# NEW REGIMENTAL OPTIONS

*“What makes a fighting man? I say faith in the Emperor and a lasgun. But there are those who say that the lasgun is optional.”*

—Knight-Lieutenant Omar Kelleinos,  
101st Samosene Musketeers

As with all matters on Lathe-Hadd, the deployment of the Crimson Guard has sparked strong disagreement amongst the factions. Some see it as a waste of resources, or an effort to distract from the troubles currently facing the Lathe World. Some believe Wahh saw the Crimson Guard of the 10th maniple as a threat to his political ambitions, for they are not known to engage in the espionage that dominates the world, and cannot be bought. Regardless, the 10th maniple obediently follow the dictates of the Forge Master, under the command of Celerius Tribunus Ovathor Coryx. Coryx is believed to be amongst the longest-serving of Lathe-Hadd’s Crimson Guard, with decades, perhaps centuries, of experience. This makes Coryx uniquely suited to lead the 10th maniple’s actions in the Spinward Front, but it is also this experience—and the respect he has earned from the Magi of Lathe-Hadd—that makes the Celerius Tribunus a potential threat to Forge Master Wahh. Coryx believes the utmost virtue is to perform one’s task to the utmost ability, and it is known that schemes and aspirations of the forge world’s leaders do not sit well with the venerable Crimson Guard. Nonetheless, the atmosphere of Lathe-Hadd has infected Coryx, who is himself one of the great believers in conspiracy theories regarding the Forge Master’s reasons for assigning him to the Spinward Front. He shares these concerns only with his most trusted Triarii. In keeping with his principles, however, the Celerius Tribunus undertakes each mission with solemnity, prosecuting it to the best of his ability.

The following Regimental Options provide players and Game Masters with additional options for the creation of both player and NPC Imperial Guard Regiments from across the Calixis Sector and the wider Imperium. These options broaden the possibilities for Regiment Creation, while some individual options are more narrow than those included in the **ONLY WAR** Core Rulebook. Though some options might seem to overlap with existing ones, these new choices will allow players more leeway in constructing the kind of Regiment they want to play.

## NEW HOME WORLDS

As the **ONLY WAR** Core Rulebook explains, a regiment’s home world does more to define it than nearly any other factor. This is especially true for some of the following new Home Worlds and Origins. Characters from the Lathe Worlds, Ogryn Worlds, and Ratling Worlds are fundamentally different from Imperial Guardsmen from other worlds, either by dint of their abnormal genetic heritage, or extensive mechanical augmentations that leave them as something other than human. In addition to these unique Traits, these home worlds instill Characteristics, Talents, and Skills just as all home worlds do.

Like those presented in the **ONLY WAR** Core Rulebook, the following home worlds provide modifiers to the Characteristics of all Player Characters hailing from that particular regiment. In addition, a regiment’s home world provides a number of starting Skills, Talents, and an assortment of special abilities that apply to each member of a regiment. Some home worlds modify a character’s starting Wounds, reflecting the general level of hardship and strife experienced by individuals from such a background, or other, more esoteric, elements. Each home world has a cost in Regiment Creation Points, which is deducted from the total budget the Game Master sets. Players can obtain additional Regiment Creation Points to spend on home worlds and Doctrines by selecting a Regimental Drawback, as explained on page 36.

While home worlds and origins normally provide bonuses to two Characteristics that players choose from three options, two of the following home worlds are exceptions to this. Ogryn World and Ratling World characters are fundamentally different physiologically and genetically than ordinary humans, and so their differences are much more pronounced than the results of mere cultural or environmental upbringing. Consequently, these origins provide more extensive modifiers, both positive and negative, to characters’ starting Characteristics.



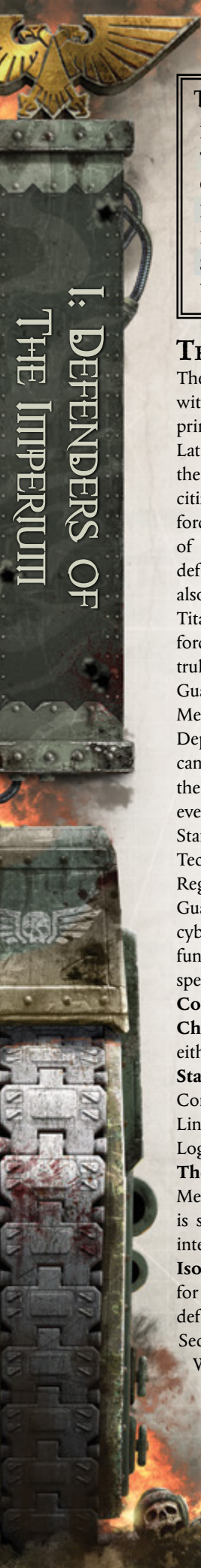

TABLE 1-1: HOME WORLDS AND ORIGINS

Home World or Origin	Cost
The Lathe Worlds	4
Ogryn World	5
Post-Cataclysmic World	3
Ratling World	3
Shrine World	3
Void Born	3

## THE LATHE WORLDS

The Adeptus Mechanicus enjoys unparalleled independence within the Imperium, an empire within an empire. The primary forge worlds of the Calixis Sector, the so-called Lathe Worlds, do not tithe manpower or raise regiments for the Imperial Guard. Instead, the Lathe Worlds select their citizens suited for military service for use in their own armed forces, including the Skitarii and the elite Crimson Guard of the Venatorii. While these forces are often tasked with defending the Lathe Worlds from attack or insurrection, they also accompany the Emperor's armies to battle, alongside the Titan Legions, Tech-Priest Engineeers, and other militant forces of the Adeptus Mechanicus. While such units are not truly Imperial Guard, they often work alongside Imperial Guard forces. In most cases, the masters of the Adeptus Mechanicus see fit to coordinate their own efforts with the Departamento Munitorum, and such Lathe Worlds Regiments can be found fighting alongside Imperial Guard forces on the battlefields of the Spinward Front. Such forces might even accept orders and missions directly from the General Staff, so long as they do not interfere with the wishes of their Tech-Priest overlords. What truly sets the elite Lathe Worlds Regiments apart from their counterparts in the Imperial Guard is not only their training and culture, but the unique cybernetic enhancements that they bear. These implants are fundamentally similar to those of Tech-Priests, but with special modifications toward military applications.

**Cost:** 4 points

**Characteristic Modifiers:** +3 to Intelligence and +3 to either Perception *or* Ballistic Skill

**Starting Skills:** All Lathe Worlds characters start with Common Lore (Adeptus Mechanicus), Common Lore (Tech), Linguistics (Low Gothic), Linguistics (Techna-Lingua), and Logic, and are Trained in Tech-Use.

**The True Flesh:** Lathe Worlds characters possess the Mechanicus Implants Trait. In addition, their potentia coil is specifically enhanced to meet the high energy needs of integrated weapons.

**Isolated by Machines:** Lathe Worlds characters are selected for a life of war at a young age, dedicating their lives to the defence of the Adeptus Mechanicus' interests in the Calixis Sector. The warriors of the Crimson Guard and other Lathe Worlds forces are unforgiving, blunt, and seem harsh to those unfamiliar with the cold, logical way the Adeptus Mechanicus operates. Lathe Worlds characters often relate to machines and servitors more readily than their flesh and blood counterparts, and have a tendency toward jargon and filling their conversations with

long strings of Techna-Lingua that are nearly unintelligible to the average trooper. Lathe Worlds characters suffer a –10 penalty to any Interaction Tests made to interact with characters who are not also from a Lathe World, forge world, or are initiates of the Adeptus Mechanicus.

**Soldiers of the Omnissiah:** The Lathe Worlds Home World represents a uniquely specific origin for a regiment. Such forces are not truly Imperial Guard regiments at all, and so do not include the Support Specialists associated with Imperial Guard regiments. Lathe Worlds characters cannot select the Commissar, Ministorum Priest, Ogryn, Ratling, Sanctioned Psyker, or Storm Trooper Specialities (they can select the Tech-Priest Engineeer Speciality). A Character from this regiment always count as both a Tech-Priest Engineeer and a Guardsman for the purposes of prerequisites, regardless of his current Speciality or Advanced Speciality. If a group wishes to include Support Specialists other than Tech-Priest Engineeers in a Lathe Worlds Squad, players should use the rules for Mixed Regiments presented in the **ONLY WAR** supplement, **HAMMER OF THE EMPEROR**.

**Wounds:** Lathe Worlds characters generate their starting Wounds normally.

## OGRYN WORLD

Ogryn worlds are those planets that are home to the hulking abhumans commonly known as Ogryns. Although the Adeptus Administratum officially classifies seven distinct types of Ogryn, the differences between these strains are minuscule in comparison to those between Ogryns and baseline humanity. Ogryns are massive, and superhumanly strong and resilient. Even the smallest Ogryns tower over the largest and most physically intimidating of normal humans. However, Ogryns are also universally dim-witted. Even those Ogryns displaying exceptional intellect must undergo additional surgical enhancement before they can be trusted to carry out tasks and instructions without direct supervision.

Unlike other origins, characters from Ogryn worlds are defined by their physical and genetic traits, rather than by their environment or culture. However, most Ogryn worlds do have certain features in common. Ogryns have evolved primarily on barren, inhospitable worlds with higher gravity than Earth. In order to survive and thrive on such planets, Ogryns require the masses of muscle which lend them such exceptional strength under normal gravity conditions. Because Ogryns are so intellectually stunted, Ogryn worlds tend toward the primitive side. Ogryns are unable to make technological advances on their own, and due to the changes in their morphology, are unable to utilise equipment inherited from their human ancestors, even were they to grasp the basic principles required to do so. In some cases, an Ogryn world might also be home to regular humans. In these cases, it usually means that human colonists have settled the world in the days since the Great Crusade, living alongside the abhumans who are descended from the original colonists. Because Ogryn worlds are so adverse to human life, such human inhabitants are more likely to be members of one or more of the Imperial Adepta, depending on what utility the world has to the Imperium.

**Cost:** 5 points

**Characteristic Modifiers:** +10 Strength, +10 Toughness, -15 Intelligence, -10 Agility, and an additional +3 to either Strength *or* Toughness

**Starting Skills:** All Ogryn world characters come from conditions so inhospitable as to be fatal to ordinary humans. Ogryn world characters start with Survival and Intimidate.

**Toughened:** Ogryns are notoriously resilient to injury, fighting on despite their wounds either through determination, sheer toughness, or simple incomprehension of their severity. Ogryn world characters gain the Die Hard *or* Iron Jaw Talent.

**Fluency:** Though they are likely to speak a debased version of their ancestral language, or else learn to upon their induction into the Imperial Guard, Ogryn world characters lack the intellectual capacity to learn how to read or write the universal language of the Imperium. Because of this, Ogryn world characters do not start with the Linguistics (Low Gothic) Skill at creation. They are still capable of engaging in any verbal communication in Low Gothic that does not require a Skill Test. However, even Ogryns who have undergone Bone 'ead surgery still speak and comprehend slowly, and verbal communication with humans who lack experience dealing with Ogryns is prone to some difficulty, at least until they come to an understanding of the Ogryns' primitive use of the language.

**Ogryn:** Ogryns are clearly identifiable as abhumans thanks to their massive bulk and monumental strength. Ogryns are capable of flipping a vehicle with their bare hands and all but ignoring wounds that would cripple or kill a normal human. Yet, these fearsome creatures are almost universally scared of dark, enclosed spaces. Ogryn characters gain the Auto-Stabilised, Size (5), Sturdy, Unnatural Strength (+2), and Unnatural Toughness (+2) Traits, as well as the Clumsy and But it Dark in Dere! Traits (see page 91 of the **ONLY WAR** Core Rulebook).

**Abhumans:** Ogryn world characters have a very specific origin. Unlike hive-worlders or death-worlders, who can pass on some of their skills and abilities, there is just no way for Support Specialists to adapt to be more like Ogryns! Therefore, Ogryn world characters cannot be Support Specialists; they can only choose from the Guardsmen Specialities. To include Support Specialists alongside Guardsmen from an Ogryn world, players should use the rules for Mixed Regiments presented in the **ONLY WAR** supplement, **HAMMER OF THE EMPEROR**.

**Narrow Focus:** Due to the restriction on Support Specialists, Ogryn world characters have fewer options when selecting a Speciality. However, unlike a lone Ogryn operating in a Squad from another regiment, Ogryns fighting alongside others of their own kind often more quickly adapt to the traditional roles of their home world. A Character from this regiment always count as both an Ogryn and a Guardsman for the purposes of prerequisites, regardless of his current Speciality or Advanced Speciality.

**Wounds:** Ogryn characters gain +15 starting wounds.

## POST-CATAclySMIC WORLD

Across the length and breadth of the Imperium, many worlds lie in ruins, testifying to some great cataclysmic event in their past. Such worlds are often little different from feral worlds or even death worlds, depending on the nature of the cataclysm. Some might even be classified as dead worlds, Imperial survey teams having failed to detect the minuscule human population living in the ruins or even beneath the planet's surface. The inhabitants of such worlds tend to focus their entire society around the past, even if their myths and stories hold only a tenuous connection to reality. It is just as common for inhabitants of post-cataclysmic worlds to shun the ruins of their ancestors' cities as cursed as it is for them to squat amongst the ruins of their forebears' accomplishments. The societies of post-cataclysmic worlds vary, from marauding techno-barbarians roving the wastes to forlorn survivors hiding in vaults underground, awaiting the day when the surface is once again safe for habitation.

Characters from these worlds tend to utilise technology, but lack any capacity for manufacture, instead maintaining and repairing the equipment left over from the time before. Because such worlds lack infrastructure and are usually too irradiated to even provide foodstuffs, their only meaningful tithe to the Imperium is in manpower, although even this is a limited resource. In some cases, only a single founding is made from such a world, its entire remaining population drafted into the Imperial Guard, leaving only an empty and dead world behind. For the individuals drafted in such events, leaving their birth world behind to fight the Emperor's wars is likely seen as a blessing.



I: DEFENDERS OF  
THE IMPERIUM



**Cost:** 3 points

**Characteristic Modifiers:** +3 to any two of the following Characteristics: Ballistic Skill, Weapon Skill, Perception

**Starting Skills:** Post-cataclysmic world characters start with Awareness, Linguistics (Low Gothic), and Survival.

**Resourceful:** Characters from post-cataclysmic worlds are used to getting by with whatever is at hand—scavenging food, equipment, and whatever else they might need. Post-cataclysmic world Characters gain a +10 bonus to Survival Tests to obtain potable food and water, and to Tech-Use Tests to jury-rig or repair equipment that is not overly advanced, as determined by the GM.

**Horrors of the Past:** Whether it occurred in living memory or far in the distant past, all post-cataclysmic world characters are scarred mentally, and perhaps physically, by the event that scoured their planet; yet those who survive in such an environment gain strength from this adversity. Post-cataclysmic world Characters start with 1d5 Insanity Points and either the Resistance (Cold), Resistance (Radiation), or Resistance (Fear) Talent.

**Wounds:** Post-cataclysmic world characters generate their starting Wounds normally.

### RATLING WORLD

Ratling worlds are those worlds home to the abhuman strain known as Ratlings. This home world is not defined by its environment, but by its population. Ratlings are short and rotund, known for their gregarious personalities, skill in marksmanship, and gluttony. Ratlings enjoy food, drink, and company, and loathe hard work. Unlike other origins, characters from Ratling worlds are defined by their physical and genetic traits, rather than by their environment or culture. However, most Ratling worlds do have certain features in common. The lifestyle that Ratlings prefer would not be possible on most worlds of the Imperium, requiring a distinct lack of danger or industrialisation. Most Ratling worlds are rather idyllic, featuring plentiful vegetation, at least in those areas home to the native population. The Imperium classifies many Ratling home worlds as either pleasure worlds or agri-worlds—although Ratlings are so resistant to hard work that a successful agri-world usually requires either the importation of ordinary human workers or a substantial force of overseers to ensure compliance by the native Ratlings. Because Ratling home worlds typically lack significant production or population, their Imperial title consists primarily of manpower. Ratling regiments are most commonly light infantry or reconnaissance regiments, which make use of the Ratlings' propensity for stealth and marksmanship. Because Ratlings lack the physical and mental fortitude that makes for good soldiers, it is rare for the Departamento Munitorum to deploy them on their own, typically detaching individual squads for deployment alongside other regiments.

**Cost:** 3 points

**Characteristic Modifiers:** +10 to Perception, +5 to Fellowship, +5 Agility, -5 Strength, -10 Toughness, and an additional +3 to either Perception, Fellowship, or Agility

**Starting Skills:** All Ratling world characters start with Awareness or Stealth, Deceive, Linguistics (Low Gothic), and Trade (Cook).

**Natural Marksman:** Despite their preferred

leisurely lifestyle, most Ratlings possess a coordination that makes them naturally adept at marksmanship. Ratling world characters begin play with the Deadeye Shot Talent.

**Ratling:** Ratlings are defined by their diminutive stature, which clearly sets them apart from ordinary Humanity. Ratling characters gain the Size (Weedy) Trait and the Heightened Senses (Sight, Smell, Taste) Talents.

**Abhumans:** Ratling world characters come from a very specific origin. Unlike hive-worlders or death-worlders, who can pass on some of their skills and abilities, there is no way for Support Specialists to become more like Ratlings. Therefore, Ratling world characters cannot be Support Specialists; they can only choose from the Guardsmen Specialities. To include Support Specialists alongside Guardsmen from a Ratling World, players should use the rules for Mixed Regiments presented in the **ONLY WAR** supplement, **HAMMER OF THE EMPEROR**.

**Narrow Focus:** Due to the restriction on Support Specialists, Ratling world characters have fewer options when selecting a Speciality. However, unlike a lone Ratling operating in a Squad from another regiment, Ratlings fighting alongside others of their own kind often more quickly adapt to the traditional roles of their homeworld. A Character from this regiment always count as both a Ratling and a Guardsman for the purposes of prerequisites, regardless of his current Speciality or Advanced Speciality.

**Wounds:** Ratling world characters begin play with -3 starting Wounds.



## SHRINE WORLD

In the Imperium of Man, entire worlds are often given over to a single purpose: manufacturing, agriculture, toil, and war, for instance. Just as important to humanity's survival however, is faith. The Adeptus Ministorum, known also as the Ecclesiarchy, is the church of the Emperor and of all Mankind. Immensely powerful, the Ecclesiarchy stands independent of the Adeptus Terra, although all work for the Imperium has a strong spiritual element, so these separate branches of Imperial power work closely together. Entire worlds, known as shrine worlds, are gifted to the Ecclesiarchy for the furtherance of the Imperial Cult. Shrine worlds vary from planet-sized cemeteries for the final rest of the devout, to massive, continent-spanning temple complexes. Under ancient decree, the Adeptus Ministorum is barred from raising men-under-arms, but many citizens of shrine worlds nonetheless find their place serving the Emperor on the field of battle, in the armies of the Imperial Guard.

**Cost:** 3 points

**Characteristic Modifiers:** +3 to Fellowship, and +3 to Weapon Skill *or* Willpower

**Starting Skills:** All shrine world characters start with Common Lore (Ecclesiarchy), Common Lore (Imperial Creed), Linguistics (Low Gothic).

**Fluency:** Characters from Shrine Worlds have been raised amidst the word of the Emperor and the splendours of the Ecclesiarchy. The lives of saints and the verses of creed are as familiar as breathing. Even for people born to such a world who are not blessed enough to be inducted into the ranks of the clergy, being constantly surrounded by hymnals, scripture, and the works of the Ecclesiarchy breeds a familiarity with High Gothic. Shrine-worlders are capable of engaging in any verbal communication or reading of High Gothic that does not require a Skill Test.

**Virtuous Ignorance:** The citizens of shrine worlds learn many lessons in virtue from the pious sermons and teachings of the Ecclesiarchy. Amongst these is the lesson that ignorance is a virtue not easily disdained by the wise. Heresy, blasphemy, and death are the just rewards of curiosity, for those who look beyond the teachings of the Adeptus Ministorum for knowledge walk a dangerous path. Due to their wise and wilful narrowness of mind, shrine world characters suffer a -10 penalty on all Forbidden Lore Tests.

**The Gift of Hate:** Shrine-worlders are accustomed to the Ecclesiarchy's teaching that hatred is amongst the Emperor's greatest gifts to mankind. Though the priests of the Adeptus Ministorum preach hatred against many various enemies of humanity, often, a particular sermon leaves an indelible impression on a shrine-worlder. Shrine world characters begin with one of the following Hatred Talents of their choice—Heretics, Mutants, or Psykers.

**Armour of Faith:** Once per session, when a shrine world character gains any number of Corruption Points, the character may spend a Fate Point to instead gain no Corruption Points from that source.

**Wounds:** Shrine world characters generate their starting wounds normally.

## VOID BORN

Many worlds in the Imperium feature orbital stations that fulfil a variety of purposes, from agri-domes and trading hubs to defence stations. Considering how heavily regimented and structured life is for most Imperial subjects, it is no surprise that many individuals born to serve aboard such facilities spend their entire lives space-bound, never setting foot on a world's surface, unless, that is, they are chosen to serve in the Imperial Guard. Because regiments are most often raised from the ranks of planetary defence forces, most such void born regiments spent time serving aboard a defence orbital. Such troopers have trained extensively in artificial and even zero-gravity environments, becoming especially adept at operating in such environments under normal conditions and in emergency situations. Void born regiments are relatively rare, and are often highly valued by the general staff for their unique skills in what are often some of the most vital and hard-fought warzones.

**Cost:** 3 points

**Characteristic Modifiers:** +3 to Willpower and +3 to either Agility *or* Perception

**Starting Skills:** All void born characters start with Common Lore (Tech), Linguistics (Low Gothic), Navigate (Stellar), Operate (Aeronautica), and Tech-Use.

**Charmed:** It is said that the void born, even those confined to a stationary orbital station, are touched by their proximity to the stars and to the Warp. Such tales attribute unnatural luck to the void born, and misfortune for others. Whenever a void born character spends a Fate Point (but not burns a Fate Point), he rolls 1d10. On a roll of 9 or 10, the Fate Point does not count as being spent, even though the character gains the chosen benefit.

**Ill-Omened:** Characters born aboard void stations often seem unusual to those from the firm ground of a planet. Life amongst the machinery and cramped corridors of a void station is quite different to life beneath an open sky, and is confining even by the standards of a hive world. Additionally, void born characters are often appear unnaturally pale and gaunt. This unwholesome air, combined with the insular, clannish ways of many void born, often causes difficulties when interacting with non-void born regiments. Void born characters suffer a -10 penalty to Interaction Tests made to interact with characters who are not also void born.

**Void Accustomed:** Void born characters have experience moving about in zero-gravity environments, whether by dint of special training, mechanical failures, or the simple necessities of life on an orbital station. Void born characters do not treat zero gravity as Difficult Terrain. In addition, the Agility Test to stay on-target when making a Charge or Run Action in zero gravity is only Difficult (-10) for void born characters.

**Wounds:** Void born characters begin play with -1 starting Wound.



## NEW TRAINING AND DOCTRINES

Like the new regimental home worlds and origins on the preceding pages, the following new Regiment Types, Training Doctrines, and Special Equipment Doctrines provide players and Game Masters with additional options for regiment creation. They broaden the range of possible regimens, while allowing for the more narrow definition of particular regiments.

### REGIMENT TYPES

The following new Regiment Types allow Game Masters and players to build regiments that are substantially different from those possible using only the options in the **ONLY WAR** Core Rulebook.

TABLE 1-2: REGIMENT TYPES

Regiment Type	Cost
Close Assault Regiment	3
Mechanised Reconnaissance Regiment	3
Rapid Reconnaissance Regiment	8
Salvage and Recovery Regiment	3
Super-Heavy Armoured Regiment	7

#### Close Assault Regiment

While comparatively rare compared to other types of infantry regiment, the Imperial Guard does raise and maintain regiments dedicated to close-quarters combat and brutal assaults. Such regiments typically come from technologically primitive worlds, where melee combat is the order of the day, but might also come from the ranks of hive gangs, post-cataclysmic worlds, or anywhere else where the inhabitants display a propensity for melee combat or close-range fire-fights. In some cases, these regiments are equipped with a transport vehicle to get them close to the enemy as quickly as possible while protecting them from

enemy fire. Others, particularly those from primitive origins, are instead assigned to warzones that utilise their talents without the need to cross open terrain, such as the depths of hives, the ruins of cities, mining tunnels, or dense jungle.

**Cost:** 3 points

**Characteristics:** +3 Weapon Skill, -3 Intelligence

**Starting Skills:** Dodge *or* Parry

**Starting Talents:** Lightning Reflexes

**Standard Regimental Kit:** One combat shotgun and four reloads *or* one great weapon *or* two one-handed low-tech weapons per Player Character (Main Weapon), one suit of Imperial Guard flak armour per Player Character, three frag grenades and two Krak grenades per Player Character.

**Special:** At a cost of an additional 2 Regiment Creation points, the regiment can add a Chimera Armoured Transport or other transport vehicle (at the GM's discretion) per Squad to its Standard Regimental Kit.

#### Mechanised Reconnaissance Regiment

While Sentinel walkers are the favoured vehicle of most reconnaissance regiments, some regiments or squads prefer to give up the all-terrain capabilities of the Sentinel in favour of armour to survive a protracted engagement and the speed to escape it. Salamander Reconnaissance Tanks are swift vehicles based on the reliable Chimera chassis. These open topped vehicles are perfectly suited to reconnaissance work, and have the speed to scout ahead of a formation and return with invaluable intelligence in short order.

**Cost:** 3 points

**Characteristics:** +3 Perception, -3 Toughness

**Starting Skills:** Awareness

**Starting Talents:** Lightning Reflexes

**Standard Regimental Kit:** One Salamander Reconnaissance Tank (or variant, at the GM's discretion) per Squad, and one set of magnoculars per Player Character.

#### Rapid Reconnaissance Regiment

Most associated with the regiments of Elysia, the Tauros rapid assault vehicle is comparatively rare amongst the Imperial Guard, its use requiring special dispensation from the Adeptus Mechanicus. Regiments able to obtain these vehicles, however, find a dependable and swift vehicle, able to traverse nearly any terrain at

speed. It is for these qualities that some reconnaissance regiments favour Tauros over the more common Sentinels. While more limited in what terrain they can negotiate, these vehicles' speed makes up for the limitation in many environments.

**Cost:** 8 points

**Characteristics:** +3 Agility, -3 Toughness

**Starting Skills:** Operate (Surface), Tech-Use

**Starting Talents:** Combat Sense *or* Accelerated Repairs

**Standard Regimental Kit:** One Tauros rapid assault vehicle and one set of Magnoculars per Player Character. At the GM's discretion, two Player Characters may exchange their individual vehicles for a single Tauros Venator.

### Salvage and Recovery Regiment

In the battles it wages against the Imperium's foes, it is unavoidable that the mighty tanks and vehicles of the Imperial Guard fall in battle alongside the soldiers themselves, despite their mighty armour. However, such is the fortitude of the Imperial Guard's tanks, that they are rarely destroyed outright—such an event occurring only if the enemy is fortunate enough to detonate fuel or ammunition stores with a lucky shot. When a battle tank or even a Chimera transport is left damaged on the field of battle, it is important to recover it as quickly as possible, before errant shots or vindictive enemies damage the wrecked vehicle beyond repair. It is up to the salvage and recovery regiments to perform this task, braving the battlefield to tow the crippled war machines to safety. This allows the Tech-Priest Engineers to soothe the vehicles' machine spirits and repair the damage, that they might roar into battle once more.

**Cost:** 3 points

**Characteristics:** +3 Intelligence, -3 Strength

**Starting Skills:** Operate (Surface)

**Starting Talents:** Nerves of Steel *or* Battlefield Tech-Wright

**Standard Regimental Kit:** One Atlas recovery tank per Squad, and one anointed maintenance toolkit per Player Character.

### Super-Heavy Armoured Regiment

To be entrusted with the care of a hallowed super-heavy tank is one of the greatest honours that might befall a squad. Super-heavy armoured regiments are rare in comparison to other types of armoured regiments, and tend to come only from worlds with close ties to the Adeptus Mechanicus. While an honour, the duty of shepherding a super-heavy tank comes with great weight of responsibility. These mighty engines of war are no mere vehicles, but divine instruments of Omnissiah's wrath. The crew of these vehicles must always respect the fearsome machine spirits within. Such regiments must also strive to protect these mighty adamantine beasts from harm; no small feat, seeing as super-heavy tanks such as Baneblades, Stormlords, and Shadowswords are likely to be deployed in the thickest and most dangerous fighting.

**Cost:** 7 points

**Characteristics:** -3 Weapon Skill, +3 Willpower

**Starting Skills:** Operate (Surface)

**Starting Talents:** Technical Knock

**Standard Regimental Kit:** One Baneblade super-heavy tank (or variant, at the GM's discretion) per Squad, and one anointed maintenance toolkit per Player Character.

## TRAINING DOCTRINES

The following Training Doctrines provide new options to reflect the skill sets and techniques that a regiment's members are expected to learn, so that the unit can better serve its designated battlefield role. Some represent official Departmento Munitorum designations, while others might reflect the culture of the regiment's home world or the way its time on the battlefields of the Spinward Front has shaped its members.

TABLE 1-3: TRAINING DOCTRINES

Training Doctrine	Cost
Crusaders	3
Defenders of the Faith	2
Defenders of the Omnissiah	3
Demolitionists	4
Sappers	3
Snipers	2

### Crusaders

While all Imperial Guardsmen are faithful to the Emperor, this is more true for some than others. The most zealous adherents to the Imperial Creed see their duty as soldiers of the Imperial Guard not only taking up arms to defend the Imperium, but as part of a holy crusade to cleanse these enemies from the very stars. Such regiments are invariably accompanied by Ministorum priests, preachers, and confessors, these fiery priests exalting the soldiers to ever greater feats in the Emperor's holy name.

**Cost:** 3 points

**Characteristics:** +2 Weapon Skill

**Starting Talents:** Frenzy and Hatred (Choose one) *or* Peer (Ecclesiarchy)

### Defenders of the Faith

This regiment is closely tied to the Adeptus Ministorum, the galaxy-spanning Ecclesiarchy that teaches the Imperial Truth and leads the worship of the Most Holy Emperor. This regiment is particularly pious in its devotions, and is sure to be accompanied by preachers, confessors, and other warriors representing the Ecclesiarchy. In battle, the soldiers of this regiment fight valiantly under the watchful eyes of the Ecclesiarchy and, should they be so blessed, the Emperor Himself.

**Cost:** 2

**Characteristics:** +3 Willpower

**Starting Skills:** Common Lore (Ecclesiarchy), Common Lore (Imperial Creed)

**Starting Talents:** Unshakeable Faith

### Defenders of the Omnissiah

This regiment is closely associated with the Adeptus Mechanicus. It might hail from a technologically advanced hive world or orbital station, or even one of the Lathe Worlds of the Calixis sector. Due to their lifelong exposure, soldiers from this regiment are much more comfortable with technology than most regiments would consider healthy, and quickly adapt to new technologies given the opportunity.

**Cost:** 3 points

**Starting Aptitude:** Tech

## Demolitionists

This regiment specialises in demolitions work, relying on powerful explosives and their precise application to bring down enemy fortifications or even to destroy vehicles or infantry formations. This doctrine could represent specialised siege training, or adapted skills from a mining background. Demolitionists often earn a reputation for recklessness, but usually maintain that their success and continued time amongst the living shows that they are, in fact, quite cautious and methodical in their work.

**Cost:** 4 points

**Characteristics:** +2 Intelligence

**Starting Skills:** Tech-Use, Operate (Surface)

**Starting Talents:** Nerves of Steel

**Standard Regimental Kit:** One Cyclops demolition vehicle per Squad, and one respirator and one-kg demolition charge per Squad Member.

**Special:** Due to their training and experience, characters from a demolitionists regiment gain an additional +10 bonuses to Tech-Use Tests made for the Demolitions special use of the Skill.

## Sappers

This regiment specialises in combat engineer duties, including erecting fortifications, building bridges and other structures, demolitions work, setting or clearing minefields, and tunnelling under enemy emplacements. While the soldiers lack the knowledge and ability of Tech-Priest Engineers, they are trained to construct, build, and fortify, although they perform such tasks almost purely by rote. The Imperial Guard utilised many prefabricated structures, designed to be erected and emplaced with minimal time and skill. Sappers often go beyond the theoretical limits of their duties and abilities, learning to use whatever is to hand when resources become scarce. While such actions might violate Departmento Munitorum edicts, they are often overlooked by officers so long as the results are worthwhile.

**Cost:** 3 points

**Characteristics:** +2 Intelligence

**Starting Skills:** Security, Tech-Use, Trade (Technomat)

**Starting Talents:** Technical Knock

**Standard Regimental Kit:** One lascutter per Player Character.

**Special:** Sappers are trained to both build and disassemble fortifications, undermine walls, and similar duties. Characters from this regiment gain a +10 bonus to Tech-Use and Trade (Technomat) Tests to construct or disassemble a structure.

## Snipers

Some light infantry or reconnaissance regiments specialise in eliminating their enemies from a distance. Utilising the long las or sniper rifle, the soldiers of this regiment hone their abilities to strike at range, preferably neutralising their targets without ever revealing their own presence. Regiments raised from Ratling home worlds are almost invariably trained and equipped as snipers rather than with the lasguns of normal infantry regiments.

**Cost:** 2

**Characteristics:** +2 Ballistic Skill

**Starting Talents:** Marksman

**Standard Regimental Kit:** One long las and 4 charge packs *or* one sniper rifle and four clips per Player Character (Main Weapon).



## SPECIAL EQUIPMENT DOCTRINES

The following Special Equipment Doctrines grant the members of a regiment access to new equipment for their Standard Regimental Kit. Some of these items are quite specialised in nature, and lend themselves to certain types of missions. GMs and players should bear this in mind when constructing a regiment using these options.

TABLE 1-4: SPECIAL EQUIPMENT DOCTRINES

Special Equipment Doctrine	Cost
Automated Artillery	2
Bonded to the Machine Cult	3
Cyber-Enhanced	3
Breachers	2
Ogryn Weapons	1
Reliquary	1
Sabre Battery	3
Servitor Accompaniment	2

### Automated Artillery

A wide variety of regiments make use of Tarantula Sentry Guns, using these automated artillery pieces to supplement their own offensive capabilities or to provide additional defence. While sentry guns are especially prized by regiments that are under-strength or engaged in seemingly endless wars of attrition or urban campaigns, they also find use supplementing manual artillery pieces or fortifying a drop-trooper beachhead.

**Cost:** 2 points

**Standard Regimental Kit:** One Tarantula Sentry Gun per Squad.

### Bonded to the Machine Cult

This regiment is bonded to the Tech-Priesthood of Mars by ancient decree. The regiment's home world maintains close ties with the Adeptus Mechanicus, producing advanced weaponry that is usually the purview only of the forge worlds. Consequently, the regiment is able to obtain such weapons more easily either from their home world or even directly from the Adeptus Mechanicus.

**Cost:** 3 points

**Standard Regimental Kit:** The regiment gains an additional +10 on all Logistics Tests to obtain Plasma, Melta, and Power weapons, and other items of advanced technology at the GM's discretion.

### Cyber-Enhanced

This regiment has very close ties with the Adeptus Mechanicus, or perhaps is even of the Lathe Worlds. In either case, the regiment believes in the superiority of the machine over flesh, and its members gladly accept the blessings of the Omnissiah to replace their biological parts. From bionic limbs to enhanced senses, these cybernetic enhancements serve to increase the regiment's abilities in battle.

**Cost:** 3 points

**Standard Regimental Kit:** All characters in this regiment begin with two Common-Craftsmanship cybernetics or one Good-Craftsmanship cybernetic (the specific cybernetics are subject to the GM's approval).

### Breachers

A variety of specialised equipment is available for use by siege regiments and other Imperial Guard forces assigned to attack enemy fortifications. Some specialized combat engineer, sappers, or assault units are granted the use of a Hades Breaching Drill to tunnel under enemy lines or undermine existing, enemy-held tunnels or fortifications. Such work can be extremely dangerous, both for the desperate close-quarters fighting that inevitably results and for the lack of structural stability of such tunnels.

**Cost:** 2 points

**Standard Regimental Kit:** One Hades Breaching Drill per Squad.

### Ogryn Weapons

For regiments raised from Ogryn home worlds, or regiments that include a sizeable contingent of Ogryn auxilia amongst their number, it is vital that these hulking abhumans have access to appropriate weapons. Such regiments often attempt to reach a special understanding with the Departamento Munitorium so as to assure the availability of weapons suitable for use by Ogryns.

**Cost:** 1 point

**Standard Regimental Kit:** The regiment gains an additional +10 on all Logistics Tests to obtain items with the Ogryn-Proof Weapon Quality. In addition, Ogryn characters in the regiment may add a Common Craftsmanship ripper gun and two clips (Main Weapon) to their kit, if it does not already include one.





## Reliquary

For truly pious regiments, there is no greater honour than to carry a holy reliquary into battle. While most often seen amongst shrine world regiments, Ecclesiarchy support elements attached to other regiments might sometimes arrange for the presence of a reliquary to inspire the troops or in recognition of their righteousness on the battlefield.

**Cost:** 1 point

**Standard Regimental Kit:** One reliquary per squad. The reliquary might take any number of forms, from a simple wooden box to an elaborate triptych or golden sarcophagus. What is important however, is the reliquary's contents—either some portion of the bodily remains of a saint or another object of great religious significance for the worshipers of the Emperor. Depending on the reliquary's size, it might take only a single person to carry, or five or more, but typically two characters (including Comrades) must carry it. As long as the reliquary remains in the Squad's possession, all Squad Members gain a +10 bonus to Willpower Tests and count as possessing the Unshakeable Faith Talent. In addition, the Player Characters reduce all Corruption Points gained by 1 to a minimum of 1.

## Sabre Battery

A favorite of line infantry regiments, regiments specializing in anti-aircraft work, and elite regiments with low numbers, Sabre Defence Platforms allow a single Guardsman to man two or more heavy weapons, and even engage aerial targets. Such platforms are also sometimes used by artillery regiments, siege regiments, and others likely to remain stationary, as the platforms are immobile once set up, and dismantling them is a time-consuming affair. This lack of mobility means that Guardsmen issued with Sabres are expected to defend key objectives, holding their ground against all odds with no option for retreat. In these cases, the issuing of Sabre Defence Platforms is seen not so much as a blessing as a death sentence.

**Cost:** 3 points

**Standard Regimental Kit:** One Sabre Defence Platform per Player Character.

## Servitor Accompaniment

Regiments with close ties to the Adeptus Mechanicus are sometimes known to make extensive use of servitors, bolstering squads with these hardy and fearless soldiers. Such regiments might also rely on their Tech-Priest Engineeers to ensure that mortally wounded Guardsmen continue to fight on in the Emperor's name, although fighting alongside a lobotomised cyborg with the face of a former friend can inevitably cause morale problems.

**Cost:** 2 points

**Standard Regimental Kit:** Characters in this regiment may select Servitor Comrades (see page 121) for their Comrades.

# NEW REGIMENTAL DRAWBACKS

The Regiment Creation Rules presented on page 58 of the **ONLY WAR CORE** Rulebook give players and Game Masters a wide variety of options for designing and customising regiments. The following Regimental Drawback rules offer a chance to further customise a regiment and gain extra Regiment Creation Points at the cost of additional mechanical penalties suffered by members of the regiment. When designing a regiment, Players and Game Masters may choose one of the following Regimental Drawbacks. Each Drawback has a point value associated with it (listed both on **Table 1-5: Regimental Drawbacks** and in each Drawback's description). Each Drawback lists the number of Regiment Creation Points a regiment gains for choosing that particular Drawback. This grants the players or Game Masters extra points with which to buy extra regimental options such as Equipment and Training Doctrines or to alter their Standard Regimental Kit. In addition to the bonus provided in the form of additional Regiment Creation Points, these drawbacks offer great opportunities to enhance roleplaying. Just as it is the flaws of a character that make him stand out, a flawed regiment can be much more interesting. Regimental Drawbacks help to define a regiment and the characters from that regiment, while presenting them with further challenges to overcome—the stuff of great storytelling.

TABLE 1-5: REGIMENTAL DRAWBACKS

Regimental Drawback	Extra Points
Conscripted	3
Iconoclasts	3
Primitive	5
Tainted	3
Traitors	5
Warp-Delayed	4

## Conscripted

While most Imperial Guardsmen are proud to serve their Emperor on the field of battle and gladly go to war, this is not always the case. On some worlds that lack proud martial traditions, their title of manpower must be forcibly conscripted. Commissars attached to such regiments have an unenviable task, ensuring that these unwilling soldiers fulfil their duties and obey the orders of their officers, who typically are much more inclined to serve. Although few regiments can truly be considered volunteers, this Drawback represents a regiment that truly opposed being drafted into service.

**Regiment Points:** 3 points

**Unwilling:** This regiment was forcibly conscripted, perhaps at gun point, and its members serve the Imperial Guard only grudgingly. Characters from this regiment suffer a -10 penalty to all Willpower Tests, and all Command Tests to influence members of this regiment (including Comrades) suffer a -10 penalty.

## Iconoclasts

The Adeptus Ministorum, commonly known as the Ecclesiarchy, brings the word of the Emperor to the millions of worlds of the Imperium. In a religion that spans the galaxy, it is unavoidable that there are differences in worship and belief. This, the Ecclesiarchy accommodates; in fact, on many worlds the form that veneration of the Emperor takes is adapted from the traditions of the planet's indigenous culture. Many drastically different beliefs are sanctioned by the Ecclesiarchy in order to ensure compliance and professed faith in the Imperial Creed; what the citizens of one world might consider blasphemy is a matter of inviolable doctrine on another. Yet in spite of this, there are those communities, cultures, and worlds that do not meet the Ecclesiarchy's criteria for faithfulness. This could be due to minor divergences of theology that put the local faith at odds with the sector synod, or could be a cultural aversion to or rejection of the Imperial Creed.

Such is most often the case on those worlds with limited Imperial contact, and few societies openly reject the Imperial faith, for to do so is to invite retribution from the Adeptus Ministorum or worse still, the Inquisition. However, a world's native population might pay lip service to the Imperial Creed while secretly worshipping the gods of their ancestors, or might slowly subvert the teachings of the Ecclesiarchy, bringing their ceremonies further and further from the Imperial Truth. For whatever reasons, the Adeptus Ministorum views this regiment as dangerously far from the proper faith, either due to a lack of spirituality or a mode of worship too far from the accepted norm.

Depending on the current state of affairs, the Ecclesiarchy might take extra measures to ensure obedience and piety with numerous priests, confessors, and other forces attached to the regiment (possibly against the wishes of its own commanding officers), or it might distance itself, weighing options or working behind the scenes to ensure the regiment is properly martyred to the Imperial Cult before it can spread its dangerous beliefs to others.

**Regiment Points:** 3 points  
**In the Shadows of the Ecclesiarchy's Light:** Rightfully or no, the Ecclesiarchy views this regiment with suspicion, seeing their religious practices (or lack thereof) as dangerously iconoclastic. Characters from this regiment suffer a -10 penalty to all interaction tests with the representatives of the Ecclesiarchy. For such regiments, it is common for the Adeptus Ministorum to attach additional Priests, Confessors, and other representatives, particularly if they feel the regiment is not yet beyond salvation.

However, such forces are sure to experience problems dealing with the regiment. Player Characters with the Ministorum Priest Speciality suffer a -10 penalty when interacting with NPC members of this regiment, including Comrades, but excluding the Ministorum Priest's own Comrade (it is assumed that his Comrade is either one of the few in the regiment loyal to the Ecclesiarchy's teachings, or is also an outsider). At his discretion, the GM might additionally apply this penalty to other PCs with ties to the Ecclesiarchy. The GM is encouraged to introduce additional narrative complications based on the specific nature of the regiment's relationship with the Adeptus Ministorum.

## Primitive

Some regiments drawn from primitive worlds, for all the Departamento Munitorum's efforts, resist the imperative to adapt to the technology handed them. Eventually, the Tech-Priests' objections to the Guardsmen using lasguns as clubs can result in a loss of further supplies, leaving the regiment to fend for itself, relying on the primitive weapons and tools its members have experience constructing on their home worlds. These regiments generally come from Feral or Feudal Worlds, although some Death Worlds distinctly lack any meaningful technological presence.

**Regiment Points:** 5 points

**Hopelessly Primitive:** No matter how long they fight in the Imperial Guard, the warriors of this regiment just cannot overcome their primitive ways and adapt to the advanced weaponry of the Imperial Guard. Characters from this regiment suffer a -5 penalty to Ballistic Skill and Weapon Skill Tests when using any weapon that is not from the Low-Tech weapons group, even if they possess the proper Talent to wield the weapon.

**Waste of Resources:** Due to flagrant misuse or neglect of whatever equipment it issues them, the Departamento Munitorum is loathe to assign any but the bare minimum of gear to this regiment. All Logistics Tests other than those made to obtain Low-Tech weapons suffer a -20 penalty.

**Special:** This Drawback cannot be taken by Mechanised Infantry, Armoured Regiments, or any other Regiment that includes a vehicle in its Standard Regimental Kit.





### Tainted

The men and women of the Imperial Guard must all too often face incomprehensible horrors from beyond the veil of reality. After facing the denizens of the Warp or their mortal followers, regiments are often subject to extreme measures to ensure they are free of corruption, which may mean every soldier receiving the Emperor's Mercy. Whether due to seeming purity, ignorance of just what they actually faced, or an oversight by the Departmento Munitorum, some regiments are reassigned despite bearing spiritual scars from their brush with the ruinous powers. In other cases, a regiment might begin to manifest signs of taint with no apparent explanation, while still others enlist bringing with them some taint from their home world, unknown to the Departmento Munitorum. Regardless of the nature and origin of its corruption, such a regiment must hide its dark secret lest it be purged by other Imperial forces.

**Regiment Points:** 3 points

**The Touch of the Warp:** For whatever reason, the soldiers of this regiment carry a spiritual and physical corruption, which manifests in horrific ways. Characters from this regiment begin play with 1d10 Corruption Points. In addition, characters from this regiment suffer an additional -10 penalty to Malignancy Tests and Tests to avoid gaining Mutations (see page 309 of the **Only War** Core Rulebook).

### Traitors

It is a sad fact that the men and women trained and equipped by the Departmento Munitorum frequently turn their weapons and training against the Imperium. Though knowledge of such treachery might be suppressed, misrepresented, or used as a propaganda tool depending on circumstances, it is an unavoidable fact that squads, platoons, and even entire regiments of the Imperial Guard can and do betray the Imperium. This regiment has done just that—forsaking its vows to defend the Imperium and turning against all it swore to protect. Whether due to some misguided sense of justice, devotion to the Ruinous Powers, or a tragic misunderstanding, this regiment has been declared traitorous by the Imperium, found guilty of the unforgivable sin. The regiment can never again turn to the Departmento Munitorum for aid or supplies, and is now hunted by the very army it once served. This drawback can also represent a treacherous planetary defence force, such as those which form the bulk of the Severan Dominate's forces on the Spinward Front. GMs and players should think carefully when selecting this Regimental Drawback, as it fundamentally changes the nature of an **ONLY WAR** campaign. Rather than

fighting alongside the Imperial Guard, the regiment will fight against the Imperium. The exact form of the regiment's battles depends on what allegiance they do hold, if any.

At the GM's discretion, he can apply this Regimental Drawback to a regiment or even a single Squad within a regiment after creation, representing in-game events. In this case, the regiment does not receive additional Regiment Creation points.

**Regiment Points:** 5 points

**Enemies of the Imperium:** This regiment cannot turn to the Departmento Munitorum for supplies. To represent the added difficulties of scrounging, stealing, or obtaining supplies through whatever treacherous organisation to which the regiment now belongs, the regiment begins with a Logistics Rating of 0 and suffers a -10 penalty to Logistics Tests. The GM may, at his discretion, modify this value to represent the resources of any group to which the regiment has sworn allegiance. In addition, characters from this regiment cannot purchase the Munitorum Influence Talent, although the GM may, at his discretion, make a functionally equivalent Talent available in its place (such as Severan Dominate Influence).

**Starting Talents:** Enemy (Imperial Guard) plus one Peer Talent appropriate to the regiment's situation.

### Warp-Delayed

While Warp travel is the only method by which the forces of the Imperium can traverse the distance between stars, it is dangerous and notoriously unreliable. Though the Departmento Munitorum and Imperial Navy make every attempt to compensate for the vagaries and unpredictable nature of Warp travel, some voyages face such delays that no manner of preparation can offset the damage done. It is not unknown for troop ships to arrive decades, centuries, or even millennia later than anticipated. In such cases, regiments might arrive to find the battle for which they were despatched either won or lost, resulting in confusion, the possibility of mistakenly attacking friendly forces, or facing overwhelming odds. Such a regiment might also find the Departmento Munitorum has declared them dead, missing in action, or even deserters. Such a situation can present all number of difficulties, and simply obtaining new orders can be a challenge for a regiment that has not been on the roster for generations.

**Regiment Points:** 4 points

**Officially Nonexistent:** Whenever a unit from this regiment rolls doubles on a Logistics Test, the Test counts as failed, even if the score would normally have been successful, as the Departmento Munitorum denies the request from a nonexistent regiment or freezes it in bureaucratic tape. In addition, the GM should include additional Mission Complications in most missions to represent the confusion caused by the regiment's unusual status.

**Lost Time:** Arriving at one's destination to learn that all of one's relatives and friends beyond the confines of the troop transport are long dead is a traumatic experience, to say nothing of what horrors might confront the soldiers should their destination warzone have fallen to the enemy in the intervening time. Characters from a Warp-delayed regiment begin play with 1d5 Insanity Points.

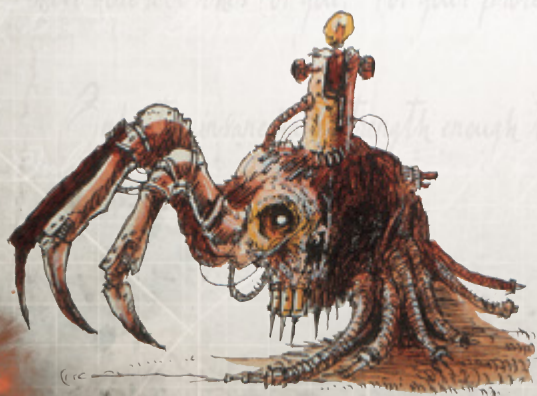

# AUXILIARY FORCES IN ONLY WAR

*“The regiment must function as a properly anointed machine. For this to happen, all elements, including support elements to the regiment and representatives of the blessed Adeptus Mechanicus, most holy Adeptus Ministorum, and any brethren from the other Imperial Adeptus, must fight as one in the service of Mankind and the Immortal Emperor.”*

—Excerpt from the *Tactica Imperialis*

The Imperial Guard forces on the Spinward Front include countless millions of ordinary men and women fighting against impossible odds with nothing but their training, flak armour, and lasguns. However, amongst these ordinary men and women are some individuals who are something more than ordinary, although their struggles are no less remarkable for this. Abhumans have their own struggles to deal with, fighting for an Imperium which largely sees them as inferiors or worse. And while abhumans have certain advantages that make them adept at specific roles in the Imperial Guard, they also have striking disadvantages compared to ordinary men and women, leaving them ill-suited for many tasks. Ratlings are agile and have uncanny senses, but are physically weak and frail, leaving them unfit for prolonged firefights or close-quarters engagements. Their size is both an advantage and a hindrance, enhancing their stealth abilities and presenting a smaller profile in long-range engagements, but meaning that even their ordinary human foes amongst the Severan Dominate tower over them—let alone the Orks of Waaagh! Grimtoof. Ogryns, of course, are quite the opposite, being larger even than an Ork Warboss, with immense strength and physical fortitude. And while Ratlings are nimble and swift, Ogryns are slow and plodding, with thick and clumsy fingers suited only for the most basic and sturdy of weapons. Additionally, Ogryns possess an extremely limited intellect, requiring assistance to comply with any but the most basic orders.

These advantages and disadvantages mean that **ONLY WAR** games with a large number of abhumans require particular considerations. In a game in which all the Player Characters are members of an abhuman regiment, the Crimson Guard, or another supplementary force, the Squad might not be suitable for certain common mission types. With any regiment, the GM should consider the nature of the Squad when preparing missions and adventures, but this is particularly true for regiments of support specialists. However, this is not to say that the GM should necessarily avoid missions that challenge the PCs' weaknesses. Such a mission, used sparingly, can make for an exciting and very different episode, and reflects the often cruel nature of both fate and the Departmento Munitorum general staff. For instance, a mission that requires a Ratling Squad to engage in vicious trench-fighting might seem inappropriate, but by highlighting

this incongruity, the GM can use it to create drama and tension—each victorious close-quarters skirmish is a considerable victory for the half-sized abhumans.

There are a number of ways that GMs and players might introduce and use such forces in their **ONLY WAR** game. At the most basic level, auxiliary forces can be introduced in the form of the Support Specialists from the **ONLY WAR** Core Rulebook. Using the options presented in this book, players and GMs can expand the place of support troops. They can select one of the regiments introduced in this chapter or create one of their own using the new options for Home Worlds and Doctrines, beginning on page 27, or using the Mixed Regiment rules found in the **ONLY WAR** supplement, **HAMMER OF THE EMPEROR** to include Player Characters from this sort of regiment alongside those from a “normal” regiment, or to introduce Support Specialists into the narrowly defined abhuman or Lathe Worlds regiments.

## AUXILIARY-ONLY GAMES

Truly, the battles of the Imperial Guard never end, and so the possibilities for **ONLY WAR** adventures and campaigns are also endless. For players seeking a change of pace, however, games in which all or most of the Player Characters are Support Specialists allow for very different styles of play. This is possible using the new regiments introduced previously in this chapter, the 5th Cyprian Huntsmen, 97th Orcan Stonecrushers, and the Crimson Guard. However, with some creative use of the new regiment creation options, players can form Squads consisting entirely of such characters. Such a group might operate on semi-permanent assignment to a traditional Imperial Guard regiment, or might operate outside the regimental structure, moving from regiment to regiment and battlefield to battlefield at the behest of the Departmento Munitorum general staff or the group's superiors within their Imperial organisation of origin. For instance, using the Shrine World origin and Defenders of the Faith doctrine, the players might create a detachment from the Ministorum, consisting of Priests, Confessors, and other specialists. While such a Squad would be possible by simply having all players select the Ministorum Priest Speciality, using the regiment creation rules allows for a wider degree of individuality between each character. Such a group might be concerned as much or more with ensuring the spiritual purity of their assigned regiment than battling the enemy, allowing for unique and interesting roleplaying opportunities. Similarly, the Shrine World origin and Crusaders doctrine would be an excellent start for a Frateris Militia force—the unofficial, volunteer fighting forces of the Ecclesiarchy. Such a force would operate at the behest of the Adeptus Ministorum rather than the Departmento Munitorum, and thus guided more by faith and belief than by strategic planning.

A Squad from an Ogryn, Ratling, or Crimson Guard regiment is very different than one from an ordinary regiment. In a way, the Squad can be thought of as consisting entirely of support specialists—after all, that's what Ogryns and Ratlings are in a “normal” regiment, and the Crimson Guard, while unique, are more akin to Tech-Priest Engineers than any other type of character. However, in an auxiliary-only regiment, the Ogryns, Ratlings, Crimson Guard,

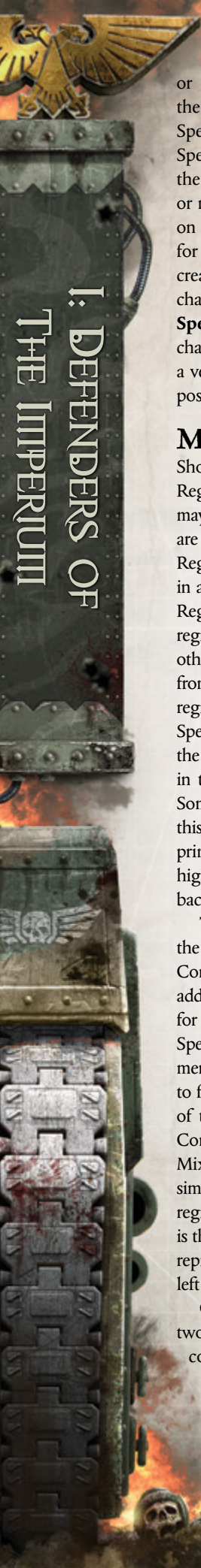

or whatever type of characters constitute the regiment of the players' creation each take on one of the Guardsman Specialities. Whereas the distinctions between Guardsmen Specialities are a game mechanic and do not typically exist on the Departmento Munitorum's records, such Specialities might or might not represent different ranks or positions, depending on the nature of the regiment. This can be a great opportunity for players and GMs to further individualise a regiment of their creation, inventing new titles to match the expertise of different character types. The new Advanced Specialities in **Chapter II: Specialist Training** provide additional options for abhuman characters. Some, such as the Ogryn Bone 'ead, do represent a very distinct rank and title, cementing a character's role and position within the Squad.

## MIXED REGIMENTS

Should the Players or the Game Master have access to the Mixed Regiment rules in **HAMMER OF THE EMPEROR** supplement, they may wish to introduce the forces in this book in that way. There are two primary ways players and GMs might use the Mixed Regiment rules to introduce support elements into their campaign in a broader or more in-depth fashion. Players can use the new Regiment Creation options in this chapter to create an abhuman regiment, Crimson Guard force, Adeptus Ministorum mission, or other body, and the Mixed Regiment rules to introduce characters from that regiment into a more common type of Imperial Guard regiment, in lieu of using the Ogryn, Ratling or other Support Specialist options in the **ONLY WAR** Core Rulebook. This has the advantage of allowing for an even greater degree of freedom in the character's Skills, Talents, Aptitudes, and other features. Some groups might also appreciate that a character created in this fashion does not take on the Home World features of the primary regiment, as is the case with Support Specialists, further highlighting the fact that these individuals come from a different background than the other Guardsmen.

The second most common way to represent auxiliaries using the Mixed Regiment rules is to use the auxiliary regiment as the Core Regiment, introducing Support Specialists via one or more additional Component Regiments. For instance, while the rules for Orcan Stonecrushers regiments do not allow for Support Specialists due to the unique nature of the Ogryns' physical and mental attributes, it is entirely appropriate for Support Specialists to fight alongside such regiments. In particular, the background of the Orcan Stonecrushers 97th makes it highly likely for a Commissar to work closely with a Squad. Using the rules for Mixed Regiments a player who opts to play a Commissar would simply work with the GM to select or create an appropriate regiment for the character. And while a Schola Progenium origin is the most obvious choice, selecting a particular regiment could represent the Commissar's previous long-term assignment, which left an indelible impression on his personality and fighting style.

Of course, the Mixed Regiment rules allow for more than two Component Regiments, and players and GMs might combine the options described above, or come up with entirely different ways to incorporate these sorts of forces, representing anything from desperate alliances behind enemy lines to patchwork forces of deserters and traitors in service to the Severan Dominate or other, darker, masters.

## INCORPORATING AUXILIARIES

When incorporating auxiliaries into a new or ongoing campaign, the GM should bear in mind the strengths and weaknesses and special skills of each when compared to the ordinary Guardsman. This extends not only to those support elements who are drastically different, but to all of them. In these latter cases, the special considerations that the GM must make are likely to be based as much on the authority or special role of the Support Specialist as on their innate abilities or Skills and Talents. For instance, an adventure which places the Squad in opposition to their officers requires careful handling if the Squad includes a Commissar. As well as accounting for the special impact of support troops on the story, GMs should strive to ensure that all characters get a chance to shine, and no one is left out because their abilities diverge from that of the Guardsmen in the regiment. Of course, such considerations should also be factored in at the outset of a campaign, during Regiment selection and character creation. A player who deems to play a Ratling in a Squad from a Close Assault regiment should expect to run into certain challenges, but the GM should also endeavour to allow him moments to shine, such as taking out a powerful enemy whom the other Guardsmen are unable to overcome in combat with a shot from his sniper rifle, or an opportunity to utilise his stealth abilities to assist the Squad in the completion of an objective.

Auxiliaries allow plentiful opportunities for roleplaying and story development. Each is an outsider to a regiment, not only those whose physical traits mark them out as different. Such forces undergo very different training and preparation, and of course are not raised from the regiment's home world at the time of its founding, while Ministorum Priests and Tech-Priest Engineers are not truly members of the Imperial Guard at all. The Guardsmen in a regiment all share a common background and culture, but this is not true for Support Specialists. This "culture clash" might create tension between characters, which can lead to exciting roleplaying opportunities both on and off the battlefield.





SPECIALIST  
TRAINING

NEW ADVANCED  
SPECIALITIES



# CHAPTER II: SPECIALIST TRAINING

*"The forces of the Enemy cannot stand before us; our numbers are legion and our conviction strong. Through faith we shall achieve victory and our foes shall be laid low at our feet. It is by our hands that those who would defy the God-Emperor shall feel his wrath, for we are the instruments of his holy will—his hammer, and his sword. Do not forget that you are his faithful servants and that, though you stand against the darkness, you do not stand alone."*

—Arch Militant Hedro Covictus from his sermon, *The Wages of Faith is Retribution*

The **ONLY WAR** Core Rulebook contains many support and auxiliary roles for players to choose from in addition to the broad specialist roles typically found within the numerous ranks of the Imperial Guard. Some, such as the enigmatic Enginseers of the Adeptus Mechanicus ensure that the vast legions that fight in the Emperor's name do not grind to a halt in the midst of their monumental task. Others, such as the zealous servants of the Ecclesiarchy work tirelessly to uphold the faith of their charges in the face of the untold horrors of warfare in the 41st Millennium. Though rightly feared and often viewed with suspicion, the abilities and support of these individuals are vital to the herculean efforts of the Imperial war machine.

## MIXED REGIMENTS

Depending on the situation, a single regiment may employ its auxiliary units in a variety of configurations and distributions. Sometimes they fight strictly as supporting units assigned to aid in a specific task or operation, while others may become permanent additions to a regiment due to compatibility, expediency, or the seemingly capricious will of the *Departmento Munitorum*. In rare events, entire regiments of such units may even deploy in response to particularly dire circumstances or extraordinary situations. Such forces are quite common among the ranks of the Adeptus Mechanicus; the armies of the Lathe Worlds and their domains in particular constituting a major power within the Calixis and adjoining sectors. This means that players are encouraged to be creative when deciding the degree to which their regiment employs Advanced Specialists and how they are organised in order to create a truly unique and memorable experience during any campaign.

Though such functions are often the domain of uniquely trained individuals from a range of Adeptas and Divisios within the inconceivably vast organs of the Imperial bureaucracy, many are merely the result of happenstance or expediency. The constant threat of war, both from without and within the Imperium's domain, often forces regiments to field troops otherwise considered unfit or unworthy to serve amongst the Emperor's servants. Such forces frequently include abhumans, creatures whose distant link with humanity is now tenuous at best. Despite the many objections of detractors and purists alike, these and other such allies often possess extraordinary talents and physical qualities that may tip the balance of war in the Imperium's favour.

This chapter of *Shield of Humanity* presents players with a diverse range of Advanced Training Specialities for many of the Support Specialists found in the **ONLY WAR** Core Rulebook. These advances allow players to significantly enhance the combat effectiveness of such characters, while allowing for a greater degree of customisation and providing unique and deadly new abilities to employ against the Emperor's foes.

## TRAINING

The abilities and talents of many Support Specialists are typically the result of such unique training and circumstance as to render them both rare and sought after within the Imperial Guard. Some, such as the enigmatic Enginseers, acquire their skills through secret instruction, rituals, and implants unknown to the uninitiated, while others receive intense conditioning from a young age or perversely benefit from their unfortunate heredity. Whatever the circumstances, every Advanced Support Specialist has distinctive Talents and abilities above and beyond those found in the **ONLY WAR** Core Rulebook. This section offers examples of some general or well-known experiences and training such troops undergo in order to fulfil their chosen role on the battlefields of the Spinward Front. However, these are merely guidelines, and players should feel free to explore additional options in order to better develop and personalise their character's motivations and personality.

## TACTICS

The staggering diversity displayed within the uncounted regiments of the Imperial Guard means that almost no two forces are exactly alike, and units that may fulfil similar battlefield functions rarely operate in exactly the same manner. Likewise, the Advanced Specialists defined in this chapter may actually encompass countless unique individuals, each of which may employ a diverse range of tactics, temperaments, and methodologies against their many foes within the Spinward Front. This section provides players with descriptions of some of the more widely observed of these behaviours; however, players would do well to come up with additional variations on these examples based on their character's individual personality traits, capabilities, and role within his unit.



## GAINING ADVANCED SPECIALITIES

The Advanced Specialities in this chapter are designed as optional advances for Support Specialist Characters including: Ministorum Priests, Ogryn, Ratlings, and Tech-Priest Engineers. Each represents the culmination of years of specialised training with a focus on a specific combat role and every entry clearly designates which Support Specialist is eligible for the Advance within its description. Additional rules for creating these Support Specialist Characters can be found within the **ONLY WAR** Core Rulebook.

Characters belonging to the Advanced Specialities presented in this chapter count as members of their prerequisite Speciality for the purposes of fulfilling the prerequisites of other Advanced Specialities, Talents, and Orders. For instance, a Player Character that has entered the Incinerant Priest Advanced Speciality is considered a Ministorum Priest for the purposes of fulfilling Prerequisites for Talents and Orders, while a PC that has entered the Fixer Advanced Speciality is considered a Ratling for the same purposes.

During the course of their deployment, Support Specialists are often presented with the ability to further specialise in their chosen form of warfare at certain milestones within their military service. With the GM's permission, a Player Character may gain the opportunity to take Advanced Specialities upon reaching 2,500 Experience Points as well as every time he earns 2,500 xp thereafter (5,000 xp, 7,500 xp, 10,000 xp, 12,500 xp, etc.) At such times, a Player Character is given a choice as to how he wishes to progress in his chosen role.

### SWITCH TO AN ADVANCED SPECIALITY

At each of these Experience Point Milestones, a Player Character may select an Advanced Speciality for which he is eligible (the character requirements for each Speciality are outlined in the entry in question). If he does so, the Advanced Speciality replaces all of his previous Speciality's Aptitudes and Specialist Equipment. He retains any Advances that he received for entering his old Speciality and any that he purchased while in that Speciality (including Comrade Advances, which he can still use in his new Advanced Speciality). He also retains any Characteristic Bonuses granted him by his original Speciality.

### SWITCH TO ANOTHER ELIGIBLE SPECIALITY

Alternatively, Support Specialist Player Characters may opt to switch to another Advanced Speciality for which they are eligible or revert to the original Support Specialist Role outlined in the **ONLY WAR** Core Rulebook. If he does so, his new Speciality replaces all of his previous Speciality's Aptitudes and Specialist Equipment. He retains any advances that he received for entering his old Speciality and any that he purchased while in that Speciality (including Comrade Advances, which he can still use in his new Speciality). However, he does not apply any of the Characteristic Bonuses from the new Speciality he is entering; instead, he retains the Characteristic Bonuses granted to him by his original Speciality.

### DEDICATION TO CURRENT SPECIALITY

Finally, any Player Character (both Guardsman and Support Specialist) can choose to dedicate himself to his current Speciality when he reaches one of these Experience milestones instead of switching to a different Speciality. If he does so, he gains a permanent +5 Bonus to any Characteristic with which he shares an Aptitude, but cannot select a new Speciality or Advanced Speciality at this milestone.

## REGIMENTAL VARIATIONS

The soldiers of the Imperial Guard are drawn from the furthest corners of the Imperium, from harsh and unforgiving death worlds to poverty-stricken underhives. In addition, each regiment may have its own culture and martial traditions, all of which reflect its unique history, its achievements, failures, and the circumstances of its founding. This section portrays examples of the ways some of the more well-known regiments field the Support Specialists found in this chapter during combat as well as the roles they may fulfil within their units. However, the practices shown here are by no means the only way such Specialists may be employed on a battlefield, and each player should feel free to develop their own niche within the unit they serve. Instead, this section should serve as a guide for both GM's and players when incorporating the abilities and attributes of the Support Specialists into their Regiment's distinctive personality and methodology.

## ADVENTURE SEEDS

Each of the descriptions of the new Advanced Specialities includes advice for Game Masters looking to integrate them into their campaigns, as well as more specific gaming ideas in the form of Adventure Seeds. Of course, the GM need not tailor entire encounters to appeal to the skills and play style of individual Specialists, but shining the spotlight on one particular player, even if only for a single session, can often make the game that much more engaging. Over the course of a campaign, the Game Master can focus on all of the players in turn, ensuring each has a chance to shine. These attentions can also serve to further highlight the unique abilities of the Specialist, and demonstrate his usefulness to his squad mates, despite his appearance and origins. Such experiences often serve to solidify the bond between members of a unit and the outsiders who support them, their valiant deeds forever ensuring the Specialist a place of honour within the chronicles of the regiments they join.

++Authorisation Code Accepted++

++Retrieving Data Spool 9583XM9I++

++Data Spool Selection Begins++

++Excerpt from the Personal Log of Second Lieutenant Juago [data lost] of the Imperial Frigate Merciless Vengeance during the suppression of Star Fort ICSF74[data lost]++

++Thought for the Day: Judge not the righteous, lest you be judged and found wanting.++

"The boarding action went almost entirely according to plan, well according to their plan anyway. The Fort's defensive batteries were estimated at 53% capacity, with the majority of the Macro batteries and functioning lances located coreward of where the loyalist defenders had sabotaged the tertiary void couplings. Our Lathe World allies determined this weakness an ideal strike point, and our assistance was requested in support of the boarding action. The Merciless' Captain was of course honoured at this prospect, and command was given to me to follow the Crimson Guard into the breach and help put the secessionists to the sword. I'm now convinced we were merely a precaution, a fail-safe against any unforeseen complication or variable they could not account for. They didn't need our help.

The traitors never knew what hit them as the Mechanicus Cruiser powered into defensive weapon range before firing a full broadside of boarding torpedoes. Whatever manner of techno-sorcery or skill allowed their ship's helmsman to navigate through the fort's barrage; I have never seen it's like in all my years serving in the Imperial Navy. By contrast, the Crimson Guard gun servitors were far more accurate, concentrating their fire on any enemy weapons able to damage the Imperial vessel. Still the assault boats took quite a drubbing, and I witnessed a great many erupt into brilliant bursts of flame as their hulls ruptured violently. Yet, though a great many perished, enough torpedoes survived that the Crimson Guard boarding force was able to crush the first defenders they encountered, their cold fury sweeping them aside like pieces on a regicide board. However, the grisly aftermath of these clashes was nothing compared to seeing their killers in action.

I saw squads of Crimson Guard move and fire in unwavering synchronization or silently break into fire teams in perfect unison to engage their targets. Every enemy push, every defensive hard point was countered instantaneously and swiftly overwhelmed; many formations even advanced along walls and ceilings, defying gravity in impossibly complex patterns of enveloping fire. They had no fear or concept of pain as they stoically marched through everything the traitors threw at them, and not one paused in their advance except when brought down by the severity of their injuries. Yet, for each that fell to the traitors' onslaught, more stepped forward to dispatch their killers with cold and merciless precision. I later learned that the Crimson Guard forces had in fact suffered only 64% casualties during the entire pacification, a figure that Factor Arimas readily assured us fell well within the Mago's acceptable range.

Emperor forgive me, I almost felt sorry for the damned traitors.

++Data Spool Ends++

### RELATIONS WITHIN THE IMPERIAL GUARD

Support soldiers often become entangled in the convoluted politics and relations between the various factions that comprise the Imperium, a reality which regularly has a profound impact on their service within the Imperial Guard. Meanwhile the pervasive atmosphere of distrust and secrecy combined with the never-ending threat of heresy among the Imperium's subjects only serves to complicate such matters. However such fears and suspicions are a constant factor of life within the Imperium, and the misgiving of a powerful few are often sufficient to condemn entire worlds to fiery absolution.

The inclusion of such auxiliary units into a regiment is rarely easy, and many often provoke various negative reactions and attitudes from their comrades depending on the Specialist in question. More zealous specialists may try to force their fervour upon those who do not share their conviction, while unusual or unnatural individuals may elicit unwanted attention from other members within a new regiment. Players and GM's should explore these attitudes and interactions throughout the course of a campaign; as such tension and hostility often help to define the relationships characters develop with their comrades in arms.

# ARCHITECTUS MAGNA

*“By the will of the Omnissiah, I have restored this tank. Now it shall act as an extension of myself. Where my flesh is weak, this glorious machine shall not fail.”*

—Primordinate Daxos, Architectus Magna

The Imperial Guard crushes its enemies under the boots of its guardsmen and the treads of its massive tanks. Behind those massive war machines stride the Tech-Priests of Mars, Engineers that keep those vehicles operating at peak efficiency and repair battle damage incurred by the enemies of the Imperium. However, even amongst that august order, there are some Engineers who have a deeper rapport with the machine spirits of the Imperial Guard war vehicles, Tech-Priests who commune with the angry heart of a Leman Russ battle tank, or coax the failing power plant of a Valkyrie back to life. Many other Tech-Priests look upon these skilled Engineers as blessed, currying particular favour with the Omnissiah and having a special bond with the machine spirits under their care.

In the Spinward Front, a Tech-Priest Engineer who demonstrates such a level of mystical understanding with Imperial Guard tanks, transports, flyers and utility vehicles is sometimes given the title Architectus Magna. With the Imperial Guard forces stretched to the limit facing both Grimtoof’s Ork hordes and the traitor regiments of the Severan Dominate, keeping the Imperium’s war machines functional is a high priority for Lord General Ghanzorik. Thus, it is no surprise that Tech-Priest Engineers distinguishing themselves with the expertise of an Architectus Magna are in high demand. There is a rumour amongst the officer corps of the Spinward Front that a secret “list” of Architectus Magna is circulated amongst many Departamento Munitorum agents and clerks, directing



## APTITUDES AND EQUIPMENT

**Prerequisite Speciality:** Tech-Priest Engineer

**New Aptitudes:** Agility, Ballistic Skill, Defence, Intelligence, Strength, Tech, Willpower

**New Talents:** Either Lightning Reflexes and Resistance (Fear) or Accelerated Repairs

**Specialist Equipment:** Sacred unguents, dataslate, combi-tool, cranial armour, mind impulse unit, respiratory filter implant, ballistic mechadendrite or utility mechadendrite (servo arm)

these precious resources wherever the fighting is thickest. Whether there is any truth to this rumour is unknown, but the Adeptus Mechanicus representatives working with the Imperial Guard high command do indeed seem to look upon the actions of an Architectus Magna with pride.

However, there may be another explanation for this attitude. Many of the Engineers who excel in the Spinward

Front in the manner of an Architectus Magna are

hand-selected by Archmagos

Ralwure the Golden of

the Lathe Worlds. This

ambitious Archmagos

has chosen to use his

influence in a bid to

acquire greater gains

for the Lathes in the

Calixis Sector—it

is whispered that he

met with Lord Sector

Hax and Lord General

Ghanzorik. Although

the details of what was

discussed have never been

revealed, Archmagos Ralwure’s

shadow has been cast over

the Adeptus Mechanicus forces

serving in the Spinward Front.

Several techna-lingua message

bursts are transmitted back to

the Lathes on a regular basis,

carrying instructions and

admonitions from the

Archmagos as he keeps

a close watch on his

interests—and the

Architectus Magna.



## SPECIALIST ADVANCES

The Architectus Magna may purchase the following Advances to enhance his own abilities and the abilities of his Servitor.

### RITE OF SYNCHRONISED STEEL

**Type:** Passive

**Cost:** 300 xp

**Effect:** While the Architectus Magna is linked with a vehicle via his mind impulse unit, he may use his Intelligence Characteristic in place of his Agility Characteristic for Operate (Surface), Operate (Aeronautica), and Operate (Voidship) Tests. Whenever the vehicle suffers Critical Damage while the Architectus Magna is linked this way, he gains 1 level of Fatigue from the associated mental strain.

### STIR, SPIRITS OF IRON!

**Type:** Full Action

**Cost:** 400 xp

**Effect:** While the Architectus Magna is linked with a multi-passenger vehicle via his mind impulse unit, so long as his Servitor is also within the vehicle, he can call upon it to temporarily enhance one of the vehicle's systems. The Architectus Magna makes a **Challenging (+0) Tech-Use Test**; if he succeeds, he can either boost the vehicle's engines or overcharge one of its weapons. If he chooses to enhance its engines, he increases the vehicle's Manoeuvrability by +5 per Degree of Success; if he decides to enhance a weapon, he increases the Damage of that weapon by +1 per Degree of Success. This effect persists for a number of Rounds equal to his Intelligence Bonus. He can only use this ability once per combat encounter.

## ARCHITECTUS MAGNA TRAINING

Those members of the Adeptus Mechanicus who serve amongst the armoured corps of the Imperial Guard are often those inducted into the deepest mysteries pertaining to vehicle restoration and war-spirit communion, their time in the cult temples on Mars likely spent as a neophyte apprentice to some of the most renowned tank-smiths and motor-magi in the Imperium. Most are gifted engineers and brilliant mechanics, who take to the roaring engines and rumbling treads of tanks and armoured personnel carriers with more ease and natural competence than a Ratling takes to theft. Many Engineers who fit the mantle of the Architectus Magna have spent decades learning their craft among their brethren in the Collegia Titanicus or even beside the caretakers of the Centurio Ordinatus. The experience gained during such apprenticeships are without equal, and few could match such a Tech-Priest when it comes to their knowledge of the engines of war.

When these learned engineers are seconded to an Imperial Guard regiment, they are often given full custodianship of the regiment's armoured support. In their care, the artillery platforms and armoured transports are treated with slavish devotion. The battle tanks and super-heavy battle engines rise from simple weapon of war, to a true expression of religious artistry.

## ARCHITECTUS MAGNA TACTICS

As one might expect, the personal tactics employed by Architectus Magna rely entirely on the application of armoured force. Just how they deploy the war machine's under their care depends greatly on the sort of regiment to which they are seconded. As an auxiliary that makes up a largely support role, an Architectus Magna is rarely responsible for determining the wider battlefield tactics of the regiments to which they are assigned. Whatever their deployment, these wise machine-priests bring their knowledge and their expertise to wield the war machines under their custodianship as potent weapons against the enemies of mankind.

## REGIMENTAL VARIATIONS

The role played by an Architectus Magna within the regiment he has been seconded to depends heavily upon the tactical doctrine of that regiment. Even the infantry-focused Catachans and Brontian Longknives make use of Sentinels and other lightly armoured vehicles. In such regiments, an Architectus Magna likely focuses on maintaining and piloting the lighter vehicles like Scout Sentinels and Hellhound flame tanks, so that they might support the efforts of the infantry platoons.

Among the more armour-dependent regiments, such as the Mordian Iron Guard and the Armageddon Steel Legion, the value of the specific erudition of an Architectus Magna is beyond estimation. With their mastery of machine-appeasement and their knowledge of rites of combustion and gear-calculation, an Architectus Magna can enhance the operation of an entire squadron of Lemman Russ Demolishers, or stir the predator-spirits of entire fleets of Devil Dog melta tanks. In such regiments, an Architectus Magna can ensure the safety of an entire platoon riding passenger aboard a column of Chimera armoured transports.

The Elysian drop troops, who make such effective use of their Valkyrie assault carriers, find the services of an Architectus Magna to be invaluable. Likewise, the cycle-mounted rough riders of the 276th Marioch Dragoons have long enjoyed the favour of the Adeptus Mechanicus and their Enginseers, so much so that their entire tactical doctrine rests upon a foundation of mechanised skirmishes and hit-and-run ambushes.

## ADVENTURE SEEDS

The Architectus Magna offers GMs a great deal of flexibility when it comes to planning encounters and other scenarios in which to involve his players. While the Architectus Magna might first appear as a purely support role, their skills and expertise lend themselves well to all manner of exciting situations. Given their mastery of heavy artillery vehicles, it is perfectly reasonable that they might be assigned to a rear-lines heavy support battery. In such a position the GM could task them with holding their position against a sweeping flank attack that has made it's way behind the Imperial Guard lines. Just as easily, as highly competent operators of transport and front-line armoured support and assault vehicles, an Architectus Magna could take part in any number of offensive engagements, and might even find themselves as a key figure in the first wave of a desperate attack against an enemy position.

Indeed, given the reliance on technology and engines of war of nearly all of the armies of the 41st millennium, an Architectus Magna might well find himself called upon to sabotage enemy armour or recover allied vehicles that are too valuable to simply leave behind enemy lines.

*My platoon was deployed to Cyclopea to help prepare the world for raising more troops—word from the High Command was that this planet was destined to provide a significant amount of reinforcements.*

*We travelled between settlements inside a Crassus armoured transport, one of the largest vehicles I'd ever seen. In fact, the Crassus makes a Lemman Russ Demolisher look small!*

*Now the Crassus is a tough, sturdy transport and looks like it can handle just about anything and we had with us Tahomus, an accomplished Tech-Priest who vastly preferred to spend his time ministering to the tank's engine rather than speaking to us.*

*Unfortunately, what we weren't ready for was a Dark Eldar raid that hit us while we were in transit. The first we knew of the attack was the screaming. One of the gunners had unwisely stuck his head out of the hatch, and the last we saw of him was his legs kicking before being pulled up into the sky. Some kind of strange, black energy beams ripped into the crew compartment and the tank shuddered to a complete halt.*

*We piled out of the Crassus and set up our heavy guns, but I won't get too far into the details of the battle—it's enough for me to say that we drove off the alien attackers at a heavy cost.*

*I found Tahomus studying the vehicle's internal workings. "How bad is it?" I asked, trying to keep my voice low out of respect for the damaged machine-spirit.*

*Tahomus let out a burst of binary static and then clarified, "Critical. I will commune with the machine spirit." He assured me. "We will get this noble beast to carry us to our destination."*

*I left Tahomus to his labours and returned to assisting the remnants of my platoon. It was not long before we heard the earth-shaking rumble of the Crassus' engines starting up, and we all breathed a sigh of relief knowing that we weren't to be stranded and alone.*

*It was actually me who boarded the Crassus last, and I nearly stopped short upon entering the hatch. I saw Tahomus standing next to the engine casing, heavy-gauge power cables connecting his own potentia coil to the damaged machine. Only a flicker of life was in the Tech-Priest's augmetic eyes, and he stood immobile as the Crassus lurched into motion.*

*Tahomus never stirred, never moved an inch during the return trip, his own bionic parts powering our salvation as the Crassus ground inexorably towards the Imperial Guard base. I couldn't hear clearly over the moans of the wounded, but I think I heard soft bursts of static emitting from the Tech-Priest's vox unit... perhaps they were prayers to the Machine God, but there is no way I will ever know for certain.*

*As the Crassus entered the base, it gave a sudden shudder and ground stiffly to a halt. Just as suddenly, Tahomus slumped to the ground, no sign of life within the Tech-Priest. Even his augmetics were unresponsive. My men and I owed our lives to the machine-priest. He had spent his life to urge the damaged war engine on.*

## RISING STORM

The Player Characters receive a missive from an Archmagos, a powerful political figure of the Lathe Worlds in the Calixis Sector. The Archmagos commands the group (if there is a Tech-Priest Enginseer amongst them) or requests them (if there is not) to assist him, hinting at greater rewards and patronage to follow. What the Archmagos is interested in is a rare and venerated super-heavy tank, a version of the Baneblade chassis known as a Stormhammer. This particular Stormhammer was damaged and presumed lost over a millennia ago during the Angevin Crusade.

The first step for the Player Characters is to locate the Stormhammer—the Game Master should consider all reasonable options. Some examples include: utilizing auspex data from Imperial Navy vessels in orbit, sending out search parties of forward sentries, coordinating Sentinel or Valkyrie patrols, and searching through Angevin Crusad-era archives for maps or journal entries. The Game Master is encouraged to allow the Player Characters to combine their actions in order to successfully locate the Stormhammer, and success should be guaranteed—the Player Characters' actions determines how quickly they locate the vehicle and if there are any complications along the way rather than a simple pass/fail.

Once the tank has been located, the Player Characters face further complications; the tank is located in a tectonically unstable area and magma flows are threatening to bury the vehicle in a matter of hours. The Game Master should adjust the time needed to recover the tank in order to keep the game's pace moving, and this threat represents a time limit to keep the Player Characters on track.

Lastly, during the recovery operation, a force of Chaos Space Marine raiders launches an attack on the Player Character group. The Player Characters are the only ones close enough to the Stormhammer to act as crew before the attack hits—the Game Master should take individual skills and abilities into account, and should present some general choices: do the Player Characters choose to accentuate the super-heavy tank's mobility or its weapon systems?

The final challenge is the Chaos force's own heavyweight—a powerful and veteran Soul Grinder (or more than one, at the GM's discretion) bellows out a challenge and lunges for the Stormhammer. The Player Characters must work as a team to make the ancient tank function well enough to defeat the attacker, and then leave the area before the magma flows erase it from the map.

## OVERDRIVE

The next time the Player Characters encounter a group of Imperial Guard machines—either their own or that of another regiment—one of the vehicles suddenly begins acting very strangely. The machine backs up, lurches forward, lights switch on and off, and turrets traverse seemingly at random. After a few seconds of this behaviour, the machine actively begins attacking the Player Characters, weapons firing one or two at a time and the main hull

trying to run down at least one of the Player Characters (for maximum fun, the GM should target the slowest or least agile character and give other Player Characters a chance to rescue him from the vehicle's treads).

The Player Characters can attempt to destroy the tank or commune with its machine spirit (if one of the Player Characters is an Enginseer, he may make a **Very Hard (–20) Tech-Use Test** to shut the machine down). If nothing else works, another Tech-Priest arrives at an appropriate time (at the GM's discretion) to shut down the machine with an expertly-timed burst of techno-lingua chanting.

The newly arrived Tech-Priest is Cavvus, an Architechus Magna who has been investigating a number of similar incidents across the warzone. Regardless of whether he helped defeat the rampaging vehicle or not, Cavvus approaches the Player Characters and explains his interest in finding out the source of these problems. Cavvus has a theory that there is some kind of erratic signal being broadcast from somewhere in the warzone that is causing severe damage to the machine spirits of many war engines, although the atmospheric have made it difficult to track down the signal's point of origin. It should be clear to the Player Characters that Cavvus is taking this situation seriously; he considers any attempt to damage the machine-spirits to be a personal affront to the Machine God, and he has made it his own righteous mission to seek out and destroy whoever dares to meddle in affairs best left to the Ommissiah's chosen.

Complicating matters is the fact that the Departmento Munitorium has a very large shipment of supplies heading through this region in ten hours' time, a convoy escorted by a significant presence of Imperial Guard armoured vehicles. If the signal is not located and shut down before then, the convoy is in serious danger of destroying itself as the machine spirits rampage unchecked.

Tracking the signal involves making a series of appropriate Tests. The GM should determine which Skills and Talents are most appropriate based on the Player Character's decisions. Tech-Use Tests are definitely appropriate if the Player Characters wish to assist Cavvus with his investigation, and doing so should be at least one step easier than any other approach.

However they accomplish it, the Player Characters should eventually discover that the signal is coming from an Ork encampment in a nearby range of mountains. A massive, ramshackle tower with a sparking, swaying transmitter dish is hidden in a small pass between two peaks. Further investigation reveals that an Ork mekboy has put together this bizarre contraption and that it is somehow responsible for damaging the Imperial machine-spirits. It is up to the Player Characters and Cavvus to find a way to defeat the Orks and destroy the mekboy's unusual machine before the Imperial Guard convoy comes into range. The GM should try and keep the pressure on the Player Characters and keep the pace of the adventure moving quickly. In addition, it is up to the GM whether this mekboy's contraption is just the first in a series of strange devices that Grimtoof has deployed against the Imperial Guard in this region, acting as the source of further adventures.

# CRIMSON EXEMPLAR

*"You have abandoned the truth of the machine. You are blasphemy. Your excuses are not our concern. Your elimination is."*

—Mortigol Caelix, Exemplar of the Lathes

The Lathe Worlds are a set of highly-developed strongholds of the Adeptus Mechanicus in the Calixis Sector, ruled over by a council of Archmagos and dedicated to protecting the secrets of the Machine Cult. Several centuries ago, a series of wars severely drained the Lathe Worlds' military forces, prompting one Archmagos—Korvikal Quietus—to formulate a special plan to eliminate this vulnerability. Archmagos Quietus assembled a group of Tech-Priests highly trained in the arts of battle. This force was named the Venatorii, but—due to their unique organization and distinctive crimson armour—those few outside the Mechanicus aware of the group's existence soon dubbed it the Crimson Guard.

The training, discipline, augmentation and wargear of the Crimson Guard set them apart as an elite fighting unit of the Lathe Worlds, and many of their number were dispatched into the Spinward Front to fend off any potential threats to the Adeptus Mechanicus in the Calixis Sector. Even amongst these celebrated warriors, there are some who stand out; Crimson Guard whose combat skills rival the most hardened veteran, with a familiarity



## APTITUDES AND EQUIPMENT

**Prerequisite Speciality:** Tech-Priest Engineer

**New Aptitudes:** Ballistic Skill, Intelligence, Offence, Strength, Tech, Toughness, Weapon Skill

**New Talents:** Either Meditation and Weapon-Tech or Integrated Weapon Expertise

**Specialist Equipment:** Sacred unguents, Omnisian axe, ballistic mechadendrite or utility mechadendrite, (servo arm), Crimson Armour, MIU weapon interface, Best Craftsmanship Lathe-lasrifle

and skill with the arcane weapons of the Machine Cult that make him a truly terrifying foe to behold on the battlefield. In the Spinward Front, Crimson Guard who excel in this manner are sometimes called Crimson Exemplars.

The presence of the Crimson Guard in the Spinward Front is part of a plan originally launched by the group's founder. Archmagos Quietus knew that his Venatorii would need extensive battlefield experience in order to truly attain a disciplined, elite force. Tech-Priests with a militant desire have many avenues in the Calixis Sector, and many become Secutors to prosecute the enemies of the Adeptus Mechanicus. However, to truly face the Machine God's foes and destroy them with extreme prejudice, such

Tech-Priests seek out a place amongst the Crimson Guard. Trained and provisioned almost entirely from the Lathe Worlds, the Crimson Guard, and the Crimson Exemplars in particular, enjoy a higher standard of logistics than many other regiments involved in the Spinward Front.

Many Crimson Exemplars who were former Secutors have requested assignments placing them in the hottest warzones. Often, these Crimson Exemplars end up fighting alongside the most elite and highly trained formations in the Spinward Front, including the Maccabian Janissaries, the Scintillan Fusiliers, and the Terrax Guard. Similarly, many Crimson Exemplars shun some of the "lesser" regiments, such as the Savlar Chem-Dogs or the Luggnum Sewer Rats. This is not to say that Crimson Exemplars refuse to work with these regiments, only that such joint operations often play out less smoothly due to inter-regimental distrust.

II: SPECIALIST TRAINING



## SPECIALIST ADVANCES

The Crimson Exemplar may purchase the following Advances to enhance his own abilities and the abilities of his Servitor.

### INTEGRATED WEAPON SYSTEMS

**Type:** Passive

**Cost:** 300 xp

**Effect:** The Crimson Guard are known for their extensive augmentations and the powerful integrated weapons that draw energy from their bodies. When a Crimson Exemplar buys this Advance, he chooses one of his Basic or Melee weapons to become an integrated weapon. That weapon is now built into his body (grafted to one of his limbs, mounted on a mechanical appendage, or otherwise attached), and can only be removed with a **Hard (-20) Tech-Use Test**. If the weapon required ammunition, it draws its power from the Crimson Exemplar's potentia coil and no longer requires fresh ammunition when reloaded, but the Crimson Exemplar gains 1 level of Fatigue every time he reloads it. The Crimson Exemplar may select this Advance a number of times equal to his Toughness Bonus.

### TARGET LOCK

**Type:** Full Action

**Cost:** 600 xp

**Effect:** The Crimson Exemplar's Servitor marks a target for annihilation, synchronising with the Crimson Exemplar's integrated weapons and allowing him to strike at his target with all of them. Once per encounter, the Crimson Exemplar may issue this Order and make a **Challenging (+0) Intelligence Test** and spend his Full Action as part of the Order; if he succeeds, he inflicts a single hit on a target within range with one of his weapons, plus an additional hit with another one of his weapons on a target within range for each Degree of Success he scored beyond the first. Each weapon can only inflict a single hit this way. The Crimson Exemplar's Servitor must be within communication range for him to issue this Order.

## CRIMSON EXEMPLAR TRAINING

The elite warriors of the Lathe Worlds undergo intense, ritualised instruction, spending decades drilling in vast training vaults learning both the ways of warfare and the esoteric machine-rites of their cult. Their combat drills involve intense focus on highly-coordinated formations that combine both overwhelming firepower and flawless melee manoeuvres. Such expertly-choreographed forms and complex battlefield procedures are rarely seen outside the training halls of Adeptus Astartes battle-barges and fortress monasteries, yet the Crimson Exemplars perform them with unwavering confidence. This is due to two major factors unique to the paragons of the Lathes.

The foremost enhancement to the training of Crimson Exemplars is their use of both traditional training regimens and potent mnemonic-coding implantation. During their instruction, each Crimson Exemplar undergoes regular and painful processes during which rote drills and complex battlefield manoeuvres are implanted directly into the memories of the engineer-soldier through an arcane combination of mnemonic-impulse interface, hypno-binary induction, and ultra-sonic cerebral etching. This process and a number of cortex implants provide the Crimson Exemplar with far greater innate understanding of tactics and heightened situational awareness.

To match their implanted tactical acumen, the Crimson Exemplars must have bodies likewise enhanced. In addition to their unforgiving physical drills and combat training, each Exemplar undergoes extensive cybernetic surgery, above and beyond that of their

Mechanicus brothers. Whirring servos and thrumming power cables rest alongside taut fibre-bundle muscle replacements and sub-dermal impact plates. Each enhancement is specifically tuned towards combat application, each augmetic limb, organ, or attachment providing the Exemplar with yet greater versatility, strength, and resilience on the battlefield.

## CRIMSON EXEMPLAR TACTICS

By and large, the Adeptus Mechanicus is not a flexible organisation. Millennia of tradition, centuries of rote repetition, and decades of superstition have all combined to build a cultish super-structure so rigid and unbending that the merest hint of change or evolution could bring down the entire edifice. Yet, even as an elite combat force belonging to such a monolithic organisation, the Crimson Exemplars are a highly flexible military machine. Their implanted combat training and cybernetic enhancements allow them to swiftly and effectively adapt to nearly any battlefield conditions.

Each member of the Crimson Exemplars is outfitted with the cybernetic augmentations to house and direct a number of in-built weapon systems. These systems are integrated directly into their flesh, alongside the numerous augmetic enhancements they already possess as a result of their indoctrination into the ranks of the Machine Cult. These integrated weapon systems are not only directed by the mind of their host, but are powered by the internal energy source each possesses in the form of their Potentia Coils. The integrated weapon systems allow the Crimson Exemplars to switch seamlessly from melee to ranged combat, facilitating their extreme battlefield versatility.

From: Sergeant Caddy, 119th Kasrkin

Commissar,

During a recent cleansing on Ganf Magna, I worked with a Tech-Priest of unsurpassed skill. This was no standard Enginseer; no, this Tech-Priest was a warrior, an elite soldier that, time after time, overcame daunting odds on the battlefield.

His designation was Seryf-12 Gamma, abbreviated by the guardsmen in my regiment to "Seryf." He was cold, mechanical even more than other Tech-Priests we had encountered during our service on Cadia. For months, every patrol with Seryf was the same, he was silent and remote to all but the most perfunctory human interaction.

During an encounter with a sizeable force of Orks we saw what the Tech-Priest was truly capable of. The greenskins attacked in a two-pronged assault, and my regiment organised ourselves to fight off the largest thrust. Seryf, however, split off on his own. When my squad and I located the warrior from the lathes, he was sitting up against a cliff face, weapons exhausted, his bionic legs damaged and spitting sparks. Serried rows of Ork corpses were splayed around him in scattered mounds. It looked as if Seryf had simply single-handedly cut them down like chaff.

Afterward, Sefyr spent several weeks undergoing significant repairs and surgery, and during his recovery, he began to study how the Kasrkin do battle, he poured over tactical plans and made suggestions for deployment of men and machines. He devised unusual strategies based on his understanding of logistics and the astrography of the Spinward Front. After weeks of integrating himself into our regiment, we had grown to respect him in turn.

Later, once Sefyr was restored to full combat readiness, he stood side-by-side with my men once more. We encountered the greenskins in a deep canyon. Not the most ideal site for a battle, but it was what we had. The Orks had brought with them a huge Squiggoth, and the massive beast was weathering our heaviest weapons as if they were little more than hailstones. As we prepared for the beast to smash into our battle-lines, a shattering series of white-hot actinic blasts arced down from the canyon's rim. Sefyr had connected to his body some kind of Mechanicus weapon I'd never seen before, and was pouring wrathful lightning into the green-skinned beast. In moments, the creature crashed to the ground, deep smouldering gouges in its hide giving off a noxious smoke.

The final result of their training and their enhancements is an extremely capable, adaptable, and resilient fighting force. The Crimson Exemplars are a powerful force in the Calixis Sector and the Spinward Front. Most often deployed in areas of fierce, unforgiving combat, the Exemplars function as the heavy shock troopers of the Lathes Mechanicus.

## REGIMENTAL VARIATIONS

Less so even than other attached forces, the Crimson Guard do not assimilate into the regiments to which they are seconded. This is due, in part, to the intense diligence with which they maintain their cult secrecy; their practices, traditions, and rituals do not change in the face of regimental secondment. Therefore, the greatest change in the Crimson Exemplars can be observed in the roles they play on the battlefield. Typically, Lathes' elite tend to function as one of two roles, depending on the strengths and weaknesses of the regiment to which they have been seconded. Given their flexibility, it is not uncommon for Crimson Exemplars to compensate for any perceived weakness that their assigned regiment has on the battlefield. Providing overwhelming firepower, stalwart melee defence, swift, armoured assaults, or coordinated combined-arms offensives, the Crimson Exemplars are able to complement nearly any Imperial Guard regiment.

## ADVENTURE SEEDS

Given their flexibility and martial resilience, Crimson Exemplars find themselves in all manner of particularly dangerous situations during their time with the Imperial Guard. Oft-times deployed to warzones that promise the fiercest fighting and most desperate odds, the soldiers of the Lathes frequently face threats that other regiments survive only through providence. Indeed for these same reasons, Crimson Exemplars are utilised as independent squads more often than most Imperial Guard regiments, working on their own to reliably achieve their mission objectives while separated from any logistical or tactical support. Of course, this is not to say that they do not fight alongside the rank and file of the Imperial Guard and, indeed, many a battle has been turned to victory by the inexorable advance and withering firepower of a unit of Crimson Exemplars.

It is of some note that while the Crimson Guard often supplement Imperial Guard regiments on the battlefield, they remain, in fact, soldiers of the Adeptus Mechanicus. It is a rare occurrence, though not entirely unheard of, that a Crimson Exemplar receives conflicting orders from his masters in the Cult Mechanicus and his commanding officers in the Imperial Guard. In such instances, the oaths of service and loyalty sworn by the Exemplar can be greatly strained.

## RESCUE FROM THE PIT

The Player Characters are ordered to undertake a rescue operation deep behind enemy lines—a Crimson Exemplar has been captured by Dark Eldar raiders, and the high command feels that bringing this Exemplar back is important to keep faith with their Adeptus Mechanicus allies. Naturally, the Imperial Guard high command wants nothing to interfere with the support of the Mechanicus in the Spinward Front, and returning the wayward Crimson Exemplar will go a long way towards keeping that relationship functioning efficiently.

The Imperial Navy has tracked the Dark Eldar to a shadowed moon in the Melquart system, where the alien raiders are using as a temporary base for their operations. On the moon's surface, the Dark Eldar have constructed a special arena where their prisoners fight to the death under torturous conditions. Because of the arena's location behind enemy lines, the Player Characters must undertake this mission without a great deal of support from the Imperial forces—a single Imperial Navy frigate will take them into the system and an Aquila shuttle, provided by the Adeptus Mechanicus and modified for stealth, will carry the group down to the moon. The Game Master should use his discretion to provide appropriate challenges for the Player Characters, from Dark Eldar patrols to encountering other alien gladiators. This rescue mission should be a tense, fast-paced adventure, so the GM should take care not to bog things down.

Once the Player Characters infiltrate the arena, they must find the Crimson Exemplar—and he is located just as he enters into a gladiatorial battle against a group of Chaos Space Marines. Once he is rescued, the Crimson Exemplar refuses to leave: he has discovered that a high-level Severan Dominate noble is also in captivity within the arena, and rescuing him as well would provide a valuable advantage for the Imperial Guard in the Spinward Front. The Player Characters must decide if the prize is worth the risk, as the Dark Eldar are not going to allow their captives to slip out of their hands without a fight.

## ONE LAST QUEST

An adept of the Administratum, acting as an advisor to the Lord General, contacts the Player Characters with a proposal. He offers to lend his considerable influence with the Lord General to their advantage if they will undertake a mission on his behalf. According to several centuries-old records uncovered by the Adept, a Tech-Priest of unsurpassed martial skill and prowess constructed a sanctuary upon Cyclopea several decades earlier and has been there ever since. This Tech-Priest's name is Hagani C'tharris, and the Adept's research indicates that he was one of the founding members of the Lathe Worlds' Crimson Guard, having earned significant accolades through dozens of bloody conflicts during the War of Brass—and most likely the inspiration for many Crimson Exemplars. Lastly, the Adept has discovered that Hagani is in possession of important Mechanicus codes that can set off scuttling charges for a strategically important orbital facility captured by the Severan Dominate.

The adept wants the Player Characters to find Hagani's sanctuary, recover the codes for the scuttling charges, and convince the retired warrior to join the fight in the Spinward Front. It is the Adept's belief that Hagani could make an important contribution to the war effort in many ways; not only is he a most deadly combatant, his presence alone could inspire greatness amongst the Adeptus Mechanicus forces committed to battle against the Severan Dominate and Waaagh! Grimtoof.

Locating Hagani's sanctuary on Cyclopea should require a number of appropriate Skill Tests from the Player Characters—the GM should use his discretion as to what Skills are appropriate, and the Player Characters should ultimately succeed. However, failed Tests could mean that they become lost or waylaid, or face some complications of the GM's devising. A **Hard (–20) Scholastic Lore (War) Test** reveals that Hagani's last assignment was to escort some replacement servitors to a core tap at the southern pole that has been long since abandoned by the Adeptus Mechanicus—at least, according to the official record.

Hagani has, indeed, taken up his hermitage at the core tap station, and the Player Characters discover that the facility has been decorated with banners and ill-maintained tactical hololiths glorifying ancient battles from the War of Brass. As they explore the station, the Player Characters find that they are being largely ignored by the numerous servo-skulls and cherubs hovering in the shadows. At the GM's discretion, the Player Characters may have to fight their way through several gun-servitors set up by Hagani to fend off the local polar-fauna that routinely make their way into the facility. Hagani is nowhere to be seen during the majority of their exploration of the hermitage, and he seems to have enforced little control over the servitor-staff of the facility. Indeed, the facility appears to be in disrepair and is only functional on the barest level.

The players locate Hagani deep within the vaults of the core-tap. They find that the Lathes-warrior has all but abandoned his duties. He seems entirely preoccupied by the construction of a massive monument, a massive memorial to the Crimson Guard's previous military exploits. As they take in the incomplete monument and the lone servant of the Omnissiah toiling away at its construction, the PCs are struck by a great sense of mourning and faded glories.

When roused from his preoccupation, the Exemplar is, at first, affronted by the PC's intrusion, but after hearing their orders, his reaction turns to indignation. Hagani is a proud warrior, and one thing he relishes about his self-enforced solitude and status in the Adeptus Mechanicus is that he need no longer bow to barked orders from the Imperial Guard. The Player Characters are free to try anything they wish to change his attitude (Charm and Intimidation Tests, for example), but any Interaction Skill used against Hagani suffers a –30 penalty due to his personal history and the fact that the Player Characters are supplicants in his own place of power.

If the Player Characters can convince him of the necessity of their orders, Hagani girds himself for war and provides the codes for the orbital facility. In addition, the GM may also provide the Player Characters with rare or unusual items of wargear that may have been collected in Hagani's armoury over the centuries.

# ENGINEER PRIME

*"It's not the drones that give me chills, it's their master. Too many eyes, that one. An' I'm not talking about the seven he's got in his head."*

—Tannog Rhyd, Ratling sharpshooter

When the Imperial Guard goes to war, they are often accompanied by Tech-Priests of Mars, specialised Engineers who are privy to the mystical secrets of the machine spirits of the regiment's armoured vehicles. The presence of an Engineer is vital for the regiment's machines to function effectively on the battlefield, and it is they who effect field repairs to damaged equipment, either alone or aided by teams of servitors. In the midst of conflicts the size of the Spinward Front, some Engineers distinguish themselves above and beyond, gaining significant experience as a veteran in dealing with nearly any damage that a war can inflict upon the sacred machine spirits of his charges. Such Engineers gain a measure of seniority and authority in dealing with Adeptus Mechanicus operations in concert with the Imperial Guard, and it is often they who coordinate actions with other Engineers in the same warzone to provide optimal efficiency in their tasks.

In the Spinward Front, an Engineer with these skills is occasionally referred to as an "Engineer Prime," referring to their breadth of experience and steady performance under fire. Excelling at general battlefield mechanical tasks, an Engineer Prime uses his skills, wargear, and augmetics to ensure that the

## APTITUDES AND EQUIPMENT

**Prerequisite Speciality:** Tech-Priest Engineer

**New Aptitudes:** Ballistic Skill, Intelligence, Perception, Knowledge, Toughness, Tech, Willpower

**New Talents:** Either Ferric Summons and Peer (Adeptus Mechanicus) *or* Battlefield Tech-Wright

**Specialist Equipment:** Sacred unguents, dataslate, Omnissian axe, calculus logi upgrade, ballistic mechadendrite, manipulator mechadendrite, and utility mechadendrite

machine spirits around him function efficiently, all the while using the weapons at his disposal—including the phalanx of servitors accompanying him—to fend off the enemy's attacks whilst the work continues.

Many commanders in the Spinward Front, including Lord General Ghanzorik, have praised the efforts of Engineers Prime in keeping their regiments moving forward even in the thick of the fiercest fighting. The Engineer Prime, of course, is not alone in his duties—he is often accompanied by a group of servitors specially designed and modified to better fulfil his own parameters. Many groups of servitors belonging to an Engineer Prime have been in service for years if not decades, patched and repaired, their biological parts worn and scarred. Such familiar tools fit well into the Engineer Prime's duties, helping him repair damaged vehicles, bolster faltering machine



II: SPECIALIST TRAINING



## SPECIALIST ADVANCES

The Enginseer Prime may purchase the following Advances to enhance the abilities of his Servitors.

### REDUNDANT SYSTEMS

**Type:** Passive

**Cost:** 300 xp

**Effect:** The Enginseer Prime gains an extra Servitor. He can select this Advance up to a number of times equal to his Intelligence Bonus. See the **Multiple Comrades Sidebar** on page 55.

### COORDINATION ALGORITHMS

**Type:** Passive

**Cost:** 400 xp

**Effect:** The Enginseer Prime optimises his Servitors to assist him in tandem, each mechanical minion acting a cog within a greater machine. When two or more Servitors assist him on a Tech-Use Test via the Servo-Arm Comrade Advance (see page 99 of the **ONLY WAR Core Rulebook**), he gains an additional +5 bonus for each Servitor that assists beyond the first.

### MACHINE LORD

**Type:** Full Action

**Cost:** 600 xp

**Effect:** The Enginseer Prime can assume precise control over his Servitors, using them to strike down his foes. Once during each of his Turns, the Enginseer Prime may make a **Challenging (+0) Tech-Use Test** as a Half Action. If he succeeds, he can have up to one of his Servitors, plus one additional Servitor per Degree of Success he scores beyond the first, make a Half Action Melee Attack Action or Ranged Attack Action against a target within range. For this attack, the Servitor uses the Enginseer Prime's Weapon Skill or Ballistic Skill in place of its own relevant Characteristic.

spirits, or leap into the fray to defend a wounded machine should it prove necessary.

As the conflict in the Spinward Front drags on, the toll upon the machines embroiled in the conflict grows ever more significant, and it is due in part to the efforts of Enginseers Prime across numerous warzones that the Lord General's forces hold the upper hand on many worlds.

## ENGINESEER PRIME TRAINING

Those highly skilled Tech-Priests designated Enginseers Prime come from many backgrounds, yet share one commonality. During their lives with the Adeptus Mechanicus, prior to their secondment to the Imperial Guard, each such Enginseers showed unparalleled proficiency and control when working with the servitors tasked to their service. Be it in the forges of the Lathe Worlds, in the Enginarium of a starship, or simply overseeing the servitor-staff of a Hive noble's household, these Tech-Priests could command greater numbers of servitors and with greater finesse and control than those around them. Few would have guessed that their talents would ever be put to use on the battlefield, but in the 41st Millennium, war claims the lives and labour of all. When events conspired to bring war to the Spinward Front, many such Tech-Adepts were called by the Cult Mechanicus to take their place among the soldiers there.

It was then that their experience of commanding dozens, if not hundreds of servitors at a time truly came into its own. Since that time, those known as Enginseers Prime have honed their ability to act

as a central command hub for a multitude of support and combat agents and have become a rare, yet indispensable asset to the regiments to which they have been assigned.

## ENGINESEER PRIME TACTICS

Anyone who has seen an Enginseer Prime in action can attest to their nigh-miraculous ability to interpret, assess, and respond to the data of dozens of active agents with little more than a thought and a punctuated burst of servitor binary. While working behind the scenes of a battle, perhaps during lulls in the fighting, or while stewarding a military camp or fortification, an Enginseer Prime puts his servitors to work, each performing menial, yet necessary functions, maintaining the defences, repairing damage inflicted during previous engagements, moving materiel from one position to another, removing the fallen from the battlements, and countless other duties. In such circumstances, a skilled Enginseer Prime could passively command several dozen, or perhaps even a few hundred servitors, simultaneously.

When the enemy draws near and every able body musters for combat, the Enginseer Prime shepherds his charges from duties of maintenance and custodianship to defence and repair. Such a change of purpose takes a great toll on the Enginseer's focus and control and, as a result, during times of immediate hostility, the number of servitors an Enginseer Prime is able to effectively command is greatly reduced, yet significant nonetheless. Even controlling a few score servitors, the Tech-Priest is a highly-valuable military asset. Whether directing those servitors equipped with heavy artillery such as heavy bolters, plasma cannons, and multi-meltas to the task of laying down suppressing fire or more directed lethal fire, committing

## MULTIPLE COMRADES

A Player Character who has multiple Comrades may issue Orders to each one, but may only give the Ranged Volley Order and Close Quarters Order (see page 270-271 of the **ONLY WAR** Core Rulebook) to one Comrade each turn. Further, a Specialist may only issue each Order relating to one of his Specialities or Advanced Specialities (past or present) to one Comrade each Turn. If a Player Character has been temporarily assigned a Comrade for any reason, then he may only issue Generic Orders to that Comrade (see page 270-271 of the **ONLY WAR** Core Rulebook).

Attacks with the Spray and Blast Qualities affect groups of Comrades normally—all Comrades within the area of effect are hit, and those outside are not (see Comrades Being Attacked on page 271 of the **ONLY WAR** Core Rulebook). If an attack is assigned to the Comrades of a Player Character with more than one Comrade because of a roll of doubles (11, 22, 33, etc.), randomly determine which Comrade suffers the hit. As usual, the attack should only be assigned to Comrades who could logically be targeted by it (see page 271 of the **ONLY WAR** Core Rulebook).

his technical servitors to the manufacture of defensive structures, or tasking them with the repair of armoured artillery, the battlefield applications of a large number of servitors is nearly endless. It is an Enginseer Prime's nature to think beyond the bounds of a single body, to perceive and react in a non-linear fashion. As a result, the tactical direction of their servitor hordes resembles nothing so much as a flock of predatory birds moving as a single murderous entity.

## REGIMENTAL VARIATIONS

Given the complexity of, and the constant need for, behind-the-scenes support in any Imperial Guard regiment, none would refuse the aid of an Enginseer Prime and the tide of servitor labour he brings with him, especially taking into account the ease with which that supplemental support can be turned to war. The skills of such a Tech-Priest are most highly prized by those regiments that make extensive use of heavily mechanised, armour-based tactics, or those that are routinely positioned to hold defensive strong points, be they highly urbanised areas or military fortifications.

For this reason, Enginseers Prime in the Spinward Front have found particular success among the ranks of the 238th Scintillan Fusiliers. These indomitable defenders of the Imperium were originally drawn from the highest ranks of Scintillan society and have spent the years since that day stationed at nearly every Imperial stronghold in the Spinward Front. Shifting from fortress to fortress as the needs of the conflict dictate, the 238th has come to rely heavily on a handful of Enginseers Prime that have followed them on each step of their wandering deployment, more than the usual Tech-Priests that tend to their vehicles and wargear. Time and again, the great fortresses manned by the 238th held against this enemy or that due to the diligent efforts of the Enginseers and their dauntless entourage of servitor warriors and labourers. Despite their continued reliance on the support provided by these elite machine-priests, the 238th Scintillan Fusiliers remain disdainful of those they consider to be beneath them. The work of an Enginseer Prime is largely thankless anyway, so the Tech-Priests have not seemed to notice. Yet, the attitude of the 238th has caused some units to suffer as they spurn the aid of their Enginseer allies and therefore lack the defensive support of such Machine Cult mystics.

By contrast, the 946th Vostroyan Firstborn honour the Adeptus Mechanicus Priests that accompany them among the urban ruins that are their speciality. Acting as mechanists, defensive engineers, and Mechanicus envoys, the Enginseers Prime that serve with the 946th are welcome additions and, in many cases, indispensable comrades-in-arms in the treacherous, crumbling ruins of the Spinward Front. Hailing, as they do from the vast Forge World of Vostroya, the 946th have an ingrained respect and even a cultish awe of these machine priests.

## ADVENTURE SEEDS

Any missions building or maintaining a defensive fortification lies directly in line with an Enginseer Prime's skills and strengths. Re-fortifying an enemy stronghold that had recently been conquered by the Imperial Guard, only to discover a dark secret hidden within might make for a very entertaining, atmospheric game as the players realise that their new fortress is not what they expect. Conversely, returning to a familiar Imperial fastness and finding it in the possession of a powerful, insidious enemy could provide for a particularly strong response from any Enginseer Prime characters, given the familiarity they would likely have with the edifice and its former inhabitants.

Indeed, barring rare instance in which the character works only with members of the Adeptus Mechanicus, Enginseers Prime make excellent emissaries from the Martian priesthood to the Imperial Guard. Each Enginseer Prime stands as the lay-person's most recognisable example of what the Tech-Priests stands for. A lone figure, nearly unrecognisable as human beneath the crimson robes of his order and heavily worked in arcane augmetics, controlling dozens of servitor-slaves with flawless precision, this is the face of the Adeptus Mechanicus that many citizens and soldiers of the Imperium of Man expect from the Red Priesthood. As such, diplomatic missions from the perspective of the Adeptus Mechanicus are also great fuel for adventures involving an Enginseer Prime.

**++Query Initiated++**

[Transcript Fragment 79215RCV-MXIV]

**++Authority Verified++**

**++Security Clearance Cobalt++**

Data Scrub Complete [G7383HL92]

**++Apostasy Rating Minimus++**

**++To Seek Enlightenment is to Invite Corruption++**

Greetings in the name of the Omnissiah.

I was selected to provide you with the information you seek regarding special individuals in the Spinward Front. Few of my priesthood have witnessed the feats of those on the front lines, yet as a member of the Crimson Guard, I find myself in the position to best aid you.

Yet, it is one of my devotion whose exploits I chose to pass on to you—an Enginseer working with the 454th Vostroyan Firstborn on Teliass. This Enginseer's designation in low gothic is Corbel, and she is a former protégé of the ill-fated Fabricator Garamond of the Lathe Worlds. Corbel chose to respond to her master's disgrace by volunteering for an assignment with the Imperial Guard, originally for the Margin Crusade. I do not know how she ended up in the Spinward Front, but I am certain that many of the Emperor's soldiery are grateful for her presence.

Corbel guides her servitors on the battlefield with masterful control and precision—I have personally witnessed her direct servitors to repair two damaged Hydras at the same time, whilst simultaneously firing her laspistol at the enemy and holding up the track chassis of a Leman Russ with her servo-arm, that her charges might gain better access to the damaged areas. She has shown great proficiency at working with nearly every vehicle in the Imperial Guard arsenal, from the most common Chimera to ancient and venerated super-heavy behemoths.

Her servitor cadre has been extensively modified to deal with common malfunctions and battle damage found in the Spinward Front, from Grot bombs to Severan Dominate sabotage, to Dark Eldar haywire grenades. Some are equipped with heavy bolters to provide covering fire whilst she salves the wounds of the vehicle's machine spirit, whilst others have multi-tools, powered grips, and welders implanted into their flesh to better carve away damaged armour plate to reach the machine's most grievous suffering.

She has a specially-modified servo-skull that is very important to her, perhaps a former comrade from the Lathe Worlds or a memento from her exiled mentor. The servo-skull has a baroque auspex of ancient provenance built-in alongside a master-crafted plasma pistol for defence. Corbel often sets this servo-skull as a perimeter warning whilst she is working in the field, relying on its auspex to inform her of incoming attack.

Corbel's quiet confidence and obvious mastery of her skills has earned her accolades from the Imperial Guardsmen she has served with, and her ident-code has garnered similar accolades amongst her peers in the Cult of the Omnissiah. Unfortunately, she has served with the Imperial Guard long past the allotted end to her secondment, yet she has refused replacement multiple times. It is good to know that the Emperor's warriors have one such as her dedicated to their cause.

Crimson Exemplar Calex-Delta-Seven

**++Transcript Ends++**

**++Query Terminated++**

## BASE CONSTRUCTION

The Player Characters are assigned by the Imperial Guard high command on Thrax to escort an Enginseer Prime to a base camp deep within a forest on the northern continent. The terrain is difficult and the trees are far too close together to allow vehicles to travel with any speed, but a large amount of raw materials and Departamento Munitorum prefabricated buildings have been air-dropped by a squadron of Valkyrie Sky Talons at the base camp location.

Travel through the forest is slow, and the Player Characters are accompanied by dozens of support staff and technical servitors. However, soon after the Player Characters have begun their journey, these accompanying NPCs begin vanishing. Left out of sight for even a moment and a tech-serf disappears, cargo dropped and blood spilled. Even the servitors vanish, their slaved-senses deadened and lost to the Enginseer Prime an instant before they vanish entirely.

The Engineeer informs the Player Characters that he has detected no sight of attacker, either through his auspex or the servitors under his compulsion. By the time the group reaches the site of the base camp, the serfs and servitors have been picked down to critically low numbers. The Player Characters must find out what exactly is preying upon the servitors—the exact nature of which is up to the GM's discretion; perhaps it is an Ork Kommando unit, elite Severan Dominate veterans, or Dark Eldar raiders—and neutralise the threat before they themselves become the target of the attacks.

Once the group arrives at the base camp, the Engineeer begins setting up a field headquarters, a plasma generator, and some hydra air defence platforms. However, the enemy has sent a raiding force to try and disrupt the construction. The Player Characters must defend the base camp long enough for the Engineeer to set up the base defences. The nature of the threat is up to the GM's discretion, but it should be a significant force and the Engineeer's work on the base defences should be the deciding contribution to the conclusion of the battle.

## A MINE TOO FAR

The Player Characters are approached by an Imperial Guard senior officer and escorted to a hololith where the officer displays a number of escalating raids by mutants on Sisk. The officer explains that the mutants are experiencing unprecedented levels of success in these raids, and that operations elsewhere in the Spinward Front could be placed in jeopardy if the raids are not stopped soon. The Imperial Guard forces on Sisk are preparing to assist a massive push elsewhere (the senior officer confidently predicts that the Lord General has decided to make an attack on Avitohol—whether this is true or not is left to the GM's discretion), so there are few reinforcements and no additional support available. The Player Characters are assigned to track down the mutant leader and end the threat of these raids.

The Player Characters have several options for locating the mutant raiders—an overflight with Valkyries, Sentinel scouts, Forward Sentries, sweeping the area with an auspex or rough riders, nearly any option can possibly succeed. It is up to the GM's discretion how long it takes for the Player Characters to find the raiders, but there shouldn't be a possibility of failure—if the Player Characters make poor choices or fail important Tests, locating the raiders should just take more time or involve some complications. The raiders are operating out of an old mining settlement in a series of foothills, and most of the mutant force—including their leadership—are all somewhere inside the mine tunnels.

Upon entering the mine, the Player Characters encounter some very unusual mutants—their limbs have been replaced with crude bionics, enhancing the mutants' fighting abilities with implanted weapons and armour. Another unique feature of these mines is that labour servitors have been outfitted with chains and are being treated as slaves by mutant overseers, whipping the unfeeling workers out of pure spite. It is obvious that the mutants are inspired by their leader to rise up from their slavish status and are exulting in their change of status by putting the servitors in their former place.

The GM should use his discretion to keep the adventure moving at a good pace. Roughly halfway through the exploration of the mine, the Player Characters encounter a makeshift prison cell containing a bedraggled, one-armed Tech-Priest. The prisoner explains that his name is Antiquis, and he was an Engineeer Prime assigned to one of the regiments hit by the mutant raids. Thought dead by his comrades, Antiquis was captured and has been forced by the mutant leader to implant the crude bionics onto the other mutants. Antiquis has a plan, however; if the Player Characters can help him reach the mine's main offices, he can use the mine's main transmitter to broadcast a signal to the servitors and use them to launch a counterattack against the mutants. While the mutants have their hands full, the Player Characters can then remove a keystone from one of the mine's main supports and begin a controlled collapse that should eliminate the mutants once and for all.

If the Player Characters succeed in the first part of the plan, all goes well—the servitors surprise the mutants by turning mining tools into improvised weapons. The second half of the plan, however, has a twist—the mine has suffered damage from the mutant uprising, not to mention years of neglect, and removing the keystone means that the mine's collapse happens much faster than Antiquis anticipated. The Player Characters must race against time to escape the mine, rescue Antiquis, and report back with news of their success.



# BONE 'EAD

*"So I asks meself, what would Colonel Straker do? Easy I says, ed probably yell at me for bloody standin' about and not smashin' things with me mates. So that's what I did. They even gave me this ere shiny medal when I was through."*

—Specialist Nift, Bone 'ead 1st class, speaking candidly about his promotion

**A**mong the dim-witted Ogryn species there exist certain rare individuals who, despite their primitive mind-set, exhibit a rare glimmer of intelligence, problem solving capabilities, memory, or natural drive. Such individuals quickly stand out among their brethren, making them ideal candidates for Biochemical Ogryn Neural Enhancement. Recipients of such procedures generally refer to themselves as Bone 'eads and possess enhanced cognitive capabilities well beyond those of an unaltered specimen. Many are able to remember their own names, count some of their fingers, or even make tactical decisions beyond hitting things—capabilities that quickly mark them as eligible for positions of limited authority.

Bone 'eads are often the brains of their units, and other Ogryn look to them for leadership both on and off the battlefield. To other Ogryns, the fact that a Bone 'ead even holds his rank is often reason enough to obey, and most are content to trust that anyone who remembers as much as a Bone 'ead probably knows best anyway. As such, a Bone 'ead's unit often has few disciplinary problems and a clearly established hierarchy, assuming everyone remembers what they are supposed to be doing at any given time.

They are brutal but effective leaders, bellowing orders over the din of combat and punctuating their shouts with vicious blows from their oversized weapons.

Where the average Ogryn is clumsy and ungainly, Bone 'eads are much more coordinated than their primitive brethren and able to

## APTITUDES AND EQUIPMENT

**Prerequisite Speciality:** Ogryn

**New Aptitudes:** Ballistic Skill, Leadership, Offence, Strength, Toughness, Weapon Skill

**New Talents:** Either Ambidextrous and Resistance (Fear) or Loyal Demeanour

**Specialist Equipment:** Good Craftsmanship cerebral implants, Good Craftsmanship ripper gun or Good Craftsmanship shock maul and Common Craftsmanship bolter, 2 frag grenades, 1 krak grenade

wield weapons with surprising dexterity, though their inherent clumsiness can never be completely eradicated. Despite their abilities, they are not particularly well equipped compared to other Guard units, often fighting with the same weaponry as their unaugmented brethren.

The main difference between a Bone 'ead and his squad mates is the cerebral implants and modifications to their thick skulls. Despite their crude and sturdy appearance, these implants are actually quite sophisticated and capable of withstanding a fairly substantial amount of punishment—particularly useful when such a device is borne by an Ogryn.



## SPECIALIST ADVANCES

The Bone 'ead may purchase the following Advances to enhance their own and the abilities of his Comrade.

### IMPROVED DEXTERITY

**Type:** Passive

**Cost:** 300 xp

**Effect:** The Bone 'ead can wield Basic and Thrown ranged weapons and Melee weapons as though he did not have the Clumsy Trait. Further, thanks to his massive size, the Bone 'ead can wield these weapons in one hand without penalty, even if they normally require both hands.

### ENHANCED INTELLECT

**Type:** Passive

**Cost:** 300 xp

**Effect:** Bone 'eads are usually more articulate than their rough brethren, and can thus communicate their needs much more efficiently to non-Ogryns. Further, the Comrades of these warriors frequently grow accustomed to their guttural, simple language. The Bone 'ead gains a +10 bonus to Tests to activate Orders that he gives to his Comrade.

### BRUTAL ENCOURAGEMENT

**Type:** Half Action

**Cost:** 400 xp

**Effect:** Ogryns delight in the havoc that a Bone 'ead can wreak, and the "little 'uns" who accompany them into the field usually take solace in the fact that such a powerful and savage warrior is on their side. The Bone 'ead's Comrade lets out an enthusiastic cry as the Ogryn slams into some terrifying foe, encouraging him and the other soldiers nearby to redouble their efforts. Until the end of the Turn, whenever the Bone 'ead kills an enemy, he may make a **Challenging (+0) Intimidate Test** as a Free Action. If he succeeds, each ally within communication range of the Bone 'ead's Comrade gains a +10 bonus to the next Weapon Skill or Ballistic Skill Test he makes before the end of the next Turn. Further, each Ogryn affected by this ability may enter a Frenzy as a Free Action (see the Frenzy Talent on page 144 of the **ONLY WAR** Core Rulebook).

In combat, the procedures enacted upon a Bone 'eads brain are put to the ultimate test as they confront numerous decisions and obstacles of command head on. However, their determination and inhuman stubbornness often see them through such situations, while their unique physiology more than compensates for any lapses in discretion or judgement. As a result, an experienced Bone 'ead is often capable of leading his fellow abhumans more or less where he is told with a little practise.

Despite their intelligence, Bone 'eads naturally exhibit many qualities that define a good leader. They tend to be driven individuals, stubborn to a fault and unwilling to back down or admit defeat in even the most hopeless situations. Such dedication is often born of absolute faith in their superiors, whom Bone 'eads trust implicitly and without reservation. They are also not afraid to lead from the front, providing an example to their fellow Ogryn and encouraging them with simple, intuitive commands accompanied by bursts of fire from their ranged weapons. It is debatable whether this is learned behaviour or simple necessity, however, as the stupidity of many Ogryn recruits may render all but the simplest orders incomprehensible.

However, despite their training and modifications, no amount of cerebral tinkering can completely eliminate the Bone 'ead's base instincts, and even the most intelligent individuals suffer from bouts of savagery. Some Bone 'eads are even equipped with implants to magnify or enhance these tendencies, turning them into engines of destruction once certain criteria are met or trigger-phrases uttered via their vox-links. Regardless, a Bone 'ead's rages are truly terrifying to behold.

## BONE 'EAD TRAINING

Training an Ogryn is a difficult and time consuming affair. However, thanks to his implants and numerous enhancements, most Bone 'eads are able to retain at least the rudiments of their training or, at the very minimum, enough information to know which direction in which to advance. Since most Ogryn recruits normally require near constant supervision, many commanders who field these units consider such results a vast improvement and well worth the effort.

Bone 'eads are very eager to please when it comes to their fellow officers, their natural loyalty towards their superiors often expressing itself through crude, child-like mimicry. To some, this means imitating personal qualities that they observe, asking themselves—literally and out loud in many cases—what that person would do in a given situation. Others may take this a step further; deliberately copying dress, habits, unit drills, or mannerisms of speech in order to more closely resemble their idol. Successful or not, these practices often stand a Bone 'ead in good stead, making them much more effective leaders in the midst of battle.

Many Bone 'eads are proficient at understanding the basics of Imperial Gothic, meaning they tend to understand more of what they hear than other Ogryn. However, even the simplest exchanges frequently require much practice on the Ogryn's part before real conversations can take place. Yet, to their credit Bone 'eads are quite willing to learn, frequently questioning their human comrades about anything they don't understand, a practice that can become quite tortuous.

Bone 'eads take their rank very seriously and are eager to prove themselves time and again, undertaking even the most dangerous and unpleasant tasks to earn the praise of their superiors. Before deployment, they are frequently heard reciting their orders over and over to themselves to make sure they get them right, or repeating them to anyone who happens to be nearby unless they also remember they are supposed to be discreet.

## BONE 'EAD TACTICS

An Ogryn assault is a primal, devastating thing. But when lent a modicum of coordination by a Bone 'ead, it can be a decisive weapon in the Imperial Guard arsenal.

Some Bone 'eads are savagely cunning leaders, executing crude but effective manoeuvres in order to enhance their unit's effectiveness in combat. The various inhibitors and synaptic intensifiers within their augmetics serve to heighten such

abilities, allowing the Bone 'ead to better control his rage while directing the fury of his unit against his despicable foes. Other Bone 'eads endure through grim determination and an unshakable loyalty to their superiors. These individuals relentlessly brave enemy fire, tanks, artillery, and other hazards, while venting their frustration against every adversary unfortunate enough to get in their way. They tend to lead by example, preferring a simple, straightforward approach to combat and often going through—as opposed to around—any hindrance or obstacle that happens to be in their path.

Those with sufficient experience often display a rudimentary understanding of tactics and strategy, leading simple counter-attacks and even avoiding enemy fire in favour of a safer approach if given time to think. Such individuals are truly unique among their peers, quickly earning a name and reputation for themselves among the brutal warzones of the Spinward Front.

*[Redacted] Acting Commander of Battle Group Lancea charged with the Purification of [Redacted] ne of the Emperor of Mankind, may his light shine forever against the darkness.*  
*Marshal Brensk, 2nd in Command of the [Redacted]*  
*ct: Recommendations for Additional Recruitment for Cranial Modification*

*My Lord,*

*I send this communique to relay to you the actions that took place during the push into Quadrant Lex 27 in accordance with your command.*

*The 204th Cadian Artillery Support Regiment, the so-called "Line Breakers", commenced its preliminary bombardment at precisely 0700 hours. After approximately 24 minutes of saturation bombing and targeted adamantium-tipped penetrator fire, the combined elements of the 106th Tallarn and Cadian Armoured and light infantry, in conjunction with the [Redacted] and Abhuman Auxiliary Support, began their push into Severan Dominate controlled territory.*

*On the second day our forward units encountered heavier and much better organised resistance from enemy armour and supporting infantry units that had apparently redeployed from an adjacent sector to reinforce the heretic lines. Though technologically inferior to our own Lemn Russ Patterns, the sheer number of enemy armoured units were unfortunately sufficient to stall our advance. In a rage, Colonel Asad of the Tallarn armoured division swore a blood oath to cut the heart out of the enemy advance, and soon his majestic formations were reaping a terrible toll on the attackers, skilfully enveloping them in a masterful alternating pincer movement that aptly demonstrated the skill of his tank crews.*

*Yet this was merely a diversionary element of a larger counter-attack, and our frontline units soon reported a wave of traitor infantry advancing on their positions. The heretics were poorly equipped and wretched in appearance; nevertheless they posed a serious threat to our units whose extended deployment left them vulnerable to such a massive and concentrated attack.*

*However, by the grace of the Emperor, the bulk of the heretic advance came into contact with regiments supported by two units of Ogryns under the command of an individual named Crod who had undergone prescribed neural modifications. According to the reports of Captain Dorah, Crod was instrumental in holding the enemy at bay, counter-attacking wherever the enemy hit and routing them easily. He notes one event in particular where Crod's unit, either by divine inspiration or dumb luck, attacked with such ferocity that they managed to break through the enemy ranks entirely. The unit, displaying uncharacteristic imagination and tactical acumen, then proceeded to encircle the traitor's lines, devastating their rear and sowing confusion which allowed our most hard-pressed units to reform and reengage their targets. As a result of this action, as well as the rapid redeployment of a column of Asad's armoured core, the enemy was repulsed with heavy losses on all fronts.*

*In light of these events, I humbly submit my request for the expertise of the Hospitaller [Redacted] in selecting additional Ogryns from my regiment for neurological enhancement. In my opinion such improvements are vital to the campaign and every effort should be made to identify suitable candidates.*

## REGIMENTAL VARIATIONS

The term Bone 'ead is fairly ubiquitous among the Regiments of the Imperial guard, encompassing both the rank and pedigree of these unique specimens. Many Bone 'eads even take the title to heart, frequently using their reinforced skulls as improvised weapons in combat. Most are selected from the units they later come to lead and have little trouble establishing their authority upon their return. Though the newly enhanced capabilities of the Bone 'ead are often sufficient to secure a leadership role, a few may be required to establish their dominance over one or two rival individuals within their squad. However, the cognitive abilities of a Bone 'ead combined with their natural strength and physical prowess often guarantees these individuals have little trouble asserting their authority.

Bone 'eads are found among almost every Ogryn unit, the implants and surgical techniques needed to create them readily available to all but the most primitive or poorly equipped regiments.

Bone 'eads often make good bodyguards in addition to their role as squad leaders. Besides their remarkable physical stature and instinctive loyalty, their increased cognitive abilities make them less apt to forget the primary elements of guard protocol while adapting to their superior's eccentricities. Those that serve in such roles are often likened to very large canids; utterly devoted to their superior and unrelentingly savage in their defence.

Bone 'ead comrades typically have at least a modicum of command experience or very minor rank within their platoon. These Guardsmen serve to keep their Ogryn companions on task and help keep them focused in battle. Many regiments have also found it helpful to have someone within the Ogryn unit capable of reacting intelligently to enemy tactics and changes in the ebb and flow of battle. As with all Ogryn comrades they tend to be robust and hardy individuals. Most eventually come to appreciate the abilities of their Bone 'ead companion, reinforcing their actions with enthusiastic cries of encouragement as the Bone 'ead crushes all before him.

## ADVENTURE SEEDS

A Bone 'ead character is, at his core, a leader, and Game Masters should always keep this in mind when designing a session involving this surprisingly capable Ogryn. Though a Bone 'ead possesses tremendous physical strength, fighting prowess, and inhuman resistance to damage, it is his leadership qualities that define him, and it only when bellowing orders that he is able to put his abilities to the greatest use. This doesn't mean the Bone 'ead cannot survive on his own, but rather that a GM should emphasise the team's performance as a whole during the course of the encounter, thereby allowing the Bone 'ead's abilities to be brought to the fore.

However, the Game Master must also remember that, for all his implants and conditioning, a Bone 'ead is still an Ogryn. He is not capable of the same levels of sophistication and planning as a human commander. Instead a Bone 'ead considers obstacles only when they bar his progress and is more likely to utilise the simplest and most obvious option

when deciding how to approach them. The Bone 'ead's commanders are acutely aware of these and other such limitations and would never assign a Bone 'ead any task that was either beyond his capabilities or exceptionally vital without some form of support. However, the player must not feel eclipsed on account of supporting NPCs or like his decisions do not matter. At the same time, the GM should not put the Bone 'ead in a situation that requires him to think like a human, a feat he simply would not be capable of performing. Instead, Bone 'eads should be given a simple objective and put in a position that provides a challenge and allows the player to accomplish his goal while proving his fundamental abilities as a commander to the rest of the unit.

## AGAINST ALL ODDS

Bone 'eads are often given jobs as guards or escorts, a practice a Game Master may utilise in this sample Adventure Seed. Though these missions are usually simple out of necessity, they are often vital as well, an Ogryn guard detail being too valuable an asset to waste on frivolous duties. Such a mission may involve guarding an officer of particular importance, a shipment of supplies from enemy attack, or a strong point from an enemy assault. The Bone 'ead's unit should also not be given orders too complicated for the Ogryn to comprehend, as his commanders rely mostly on the Ogryn's stubbornness and desire to prove himself to complete the mission successfully. So when their foes come pouring over the horizon expecting an easy win, they instead find the Bone 'ead and his unit doggedly manning their post against everything the enemy throws at them. In fact, the Ogryn's mission may be of such import, that an enemy officer may wish to oversee the assault personally.

## COMBAT TRAINING

Every unit within the Imperial Guard undergoes regular training in order to experience the rigours of combat and ensure they are prepared to withstand the enemy when the time comes. In the same way, this Adventure Seed may be a useful way to introduce a newly improved Bone 'ead back to his comrades and demonstrate his newfound capacity for leadership. This exercise may take place at any time during a campaign; including while the unit is being resupplied behind lines or in transit to a new warzone. The object is simple: the Bone 'ead must lead his unit through a live fire exercise designed to break-in newly promoted officers and force them to adapt to their new role. The course will take the Bone 'ead and his unit through a series of basic physical obstacles before culminating in an assault on a fixed enemy position manned by modified combat servitors. The nature of the obstacles is up to the Game Master and should require the use of simple tactics to traverse unscathed. However, due to the robust nature of Ogryn, the gun servitors are equipped with combat-grade weapons, making them a far more lethal foe than those used to train newly founded regiments. The Bone 'ead must discover a way to overcome this deadly, prearranged threat and prove that the faith his superiors have in his abilities is not misplaced.

# BULWARK

*"Wot one, sab? Oh, dat one dere? 'E ain't so tough lookin' ta me. Don't you worry none, sab, I'll fix em."*

—Tug the Ogryn, before slaying an Ork Nob with his own "liberated" Power Klaw

An Ogryn's primitive nature is the direct result of the harsh environment in which they develop; the cold, feral worlds of ice and death that the Ogryn species calls home providing little incentive for mental development. As such, an Ogryn embodies the most primitive aspects of humanity, though greatly enhanced and exaggerated due to their severe retrogression. Yet, in spite of their dim-wittedness, they possess an underlying savagery and hardy physique that makes them incredibly useful on the battlefields of the 41st Millennium.

The Imperium of Man often recruits these massive creatures as shock troops, arming them with crude and simple weapons before pointing them at the enemy and unleashing them on their foes. Ogryn are well suited to such tactics, their underdeveloped brains rarely registering pain and injury as they smash into the enemy's lines. Though equipped with powerful Ripper Guns, every Ogryn is highly capable in close combat, their primitive brutality and massive physiques allowing them to crush their foes with a savagery few adversaries can match.

Yet, despite this universal proficiency, there are individuals to whom the allure of smashing their enemies to a pulp and breaking their bones with blows from their massive fists is particularly appealing. These are the Ogryns who are always near the front of their unit, eagerly wading into combat with whatever weapon happens to be at hand. Some simply enjoy crushing enemy skulls to powder or tearing off limbs with their bare hands, while others may rely on their volatile temperament, flying off into a killing rage at the mere mention of their hated enemy. Some are so stupid they cannot truly comprehend the nature of their situation, delighting in what they consider an enjoyable game as they revel in the shouts of encouragement and support from their comrades. However, many simply resort to close combat because they can, their primitive brains falling back on their natural instincts in the heat of battle.

## APTITUDES AND EQUIPMENT

**Prerequisite Speciality:** Ogryn

**New Aptitudes:** Fieldcraft, Offence, Strength, Toughness, Weapon Skill, Willpower

**New Talents:** Either Frenzy and Sound Constitution *or* Vengeful Protector

**Specialist Equipment:** Good Craftsmanship mace-fist *or* Good Craftsmanship great weapon *or* Best Craftsmanship warhammer, 2 frag grenades

These sorts of Ogryns are always found at the forefront of battle, eagerly overwhelming their opponents with devastating blows from their massive fists and oversized weapons. Many tend to have little understanding of ranged warfare, either having forgone much of the training required to further their combat abilities or simply being too dense to comprehend such tactics. This makes them



## SPECIALIST ADVANCES

The Bulwark may purchase the following Advances to enhance his own abilities or the abilities of his Comrade.

### ESCALATING RAGE

**Type:** Passive

**Cost:** 400 xp

**Effect:** While the Bulwark is in a Frenzy, whenever an enemy inflicts Critical Damage upon an ally within 10 metres or hits a Comrade within 10 metres, the Bulwark increases the value of his Unnatural Strength and Unnatural Toughness Traits by +1 until the end of the encounter. These Traits cannot exceed Unnatural Strength (8) and Unnatural Toughness (8) this way.

### SHATTERING BLOW

**Type:** Passive

**Cost:** 600 xp

**Effect:** While the Bulwark is in a Frenzy, whenever he inflicts Righteous Fury with a Melee Attack, he also inflicts a hit on each other target within a number of metres equal to his Strength Bonus (other than himself) with the following profile: 1d10+SB I; Pen 0; Concussive.

generally savage even by Ogryn standards, while their size and feral aspect serves only to magnify their combat effectiveness.

As with all Ogryns, the line between placid stupidity and mindless rage is a fine one, and easily crossed in the rush of combat. The death of a companion, the harsh words of a commander, wounds inflicted by an enemy, any of these may be enough to drive such an Ogryn into paroxysms of rage at the mere sight of a foe. However, the rages of such a savage individual are a thing to behold as their primitive minds aggressively lash out at the source of their ire. This propensity towards violence often serves to make their legendarily short tempers even shorter, while a Bulwark at the height of his anger is a rampaging whirlwind of destruction that dashes his foes to pieces with the sheer force of his blows.

In combat, a Bulwark is the embodiment of primitive savagery and rage, fighting without thought of restraint or self-preservation. They instinctively attack every enemy within range, swinging their weapons with such bone-crunching force that armour buckles and bodies shatter in their wake. So intent are they on crushing their foes, they are immune to pain, injury, and fear, blindly charging through whatever obstacle stands between them and their enemy.

The sight of a Bulwark on the battlefield often provides tremendous encouragement and inspiration to his comrades as he smashes through all who stand before him. Some regiments view their Ogryn's as a sort of champion, sending them forward whenever a particularly vicious adversary appears and looking to him when all seems lost and the unit is on the verge of being overwhelmed. Time and again, as the Bulwark's mighty blows split his adversaries apart and his massive physique ignores all but the most grievous of injuries his comrades take strength from his steadfast example and push on into the bloody conflict. At other times the Bulwark may instead serve as the rock upon which the unit is grounded; an unbreakable foundation for his comrades to cling to and an endearing example of faith and devotion.

## BULWARK TRAINING

Ogryns are dim-witted and slow to learn, the centuries of devolution on their inhospitable home worlds having rid them of many of their advanced reasoning capabilities. What's more, Ogryns are known for their incredibly short memories, and their inability to retain all but the most basic information makes even the simplest drill an arduous affair. By contrast, an Ogryn's training is relatively simple, the majority requiring only repeated introductions to the basics of discipline and the names of their superiors. Many Ogryn receive little actual battlefield instruction, their commanders trusting in their savagery and hardy constitution to see him through any dangers he may face. Others instead adopt the role in response to their behaviour during battle, their volatile temperaments and violent tendencies making them particularly suited to the rigours of close combat.

This primitive behaviour usually means a Bulwark has a difficult time effectively utilising his Ripper Gun as anything other than an improvised melee weapon, and many find the operation of such weapons frustrating at best. As a result many personally discard their armaments instead improvising melee weapons more suited to their preferred method of killing. Such decisions are left up to the Ogryn himself, however, as many prefer a good sturdy club over a complicated gun and would gladly march into battle wielding little more than their fists if so ordered.

## BULWARK TACTICS

As with all Ogryns who accompany their human companions into battle, Bulwarks are frontline soldiers entirely unsuited for any combat role involving subtlety or finesse. They are blunt instruments of warfare, at their most useful when applied with the utmost force and directness. As such they are generally herded right into the heart of the enemy where their massive size and resilience allows them to punch through all but the toughest resistance. It is here, surrounded by their foes, that the Bulwark's abilities come to the fore as he smashes to the ground all who stand before him.



## FIGHTING FIRE WITH FIRE

Imperial forces on Ganf Magna have long fought a losing battle against the planet's steadily increasing population of Feral Orks, many within the lord Marshall's Command even reputedly voicing the opinion that it is only a matter of time before the planet becomes yet one more contested world within the perpetual conflict. This may in fact have already come to pass, if not for the sacrifices of the unnumbered regiments who have fought and died in countless valiant, yet futile, efforts to purify the planet of its Ork taint. These so-called "cleansings" are undertaken with increasing regularity, as every Ork slain in the dusty wastes releases hundreds of microscopic spores and thereby sows the seeds of future conflict.

Unfortunately the barbarous Orks are not content to await the coming of the Imperial Guard, and many times the green tide that erupts from the barren wastes is pushed back only with the combined efforts of both the local garrison and any regiments recovering from conflicts elsewhere. Such attacks are usually short lived, the Orks lacking sufficient resources or technology for a protracted campaign; however, the inhuman savagery of these foul xenos has frequently pushed the defenders to breaking point.

The rise of Snadgrot Bakbreaka was one such conflict, resulting in a siege that nearly shattered the beleaguered city's defences, while Snadgrot's crude and looted artillery fired shell after shell into the densely packed streets beyond the walls. After five days of relentless siege, the Warboss personally led a massive attack that carved a bloody path right up to the Third Ancillary Archway. There the Orks ran into the tattered remnants of 56th Mordian "Inflexibles" who managed to hold them at bay with highly disciplined volleys of las-fire. However, the Orks' numbers soon began to tell on the defenders and the Mordians were quickly in danger of being completely overwhelmed.

It was then that a throaty bellow sounded from within the Imperial lines and a great scarred Ogryn broke ranks and charged right into the advancing xenos. The Orks, taken aback by this unexpected assailant, paused in their assault while the thunderous strikes of the enraged Ogryn along with the supporting fire of his comrades reaped a devastating toll on the attackers. Finally Snadgrot himself stepped forward to challenge the newcomer, and the bone crunching impacts of their blows could be heard even over the frightful din of battle. Though bruised, battered, and bleeding from scores of wounds, the Ogryn continued his assault, relentlessly attacking the mighty Warboss and wearing him down, until finally snapping the Warboss's neck with a herculean effort. Their leader dead, the remaining Orks fled in complete disarray, falling in droves to the renewed assault of the Imperial defenders. The Ogryn, Gurn, had to be restrained from following the Orks back into the wilderness in his tireless rage, and many have since speculated exactly what events transpired to cause his murderous and fortuitous tirade.

Sometimes Ogryns of this type are employed strictly in this manner, serving as living battering rams to force holes in enemy lines or to draw attention from other sections of the enemy defences. Units assigned this task usually contain multiple Ogryn with the Bulwark mentality within their ranks, the added impact of several such adversaries often proving too much for all but the toughest foes. Some are even given armour to supplement their natural toughness and protect them from enemy retaliation as well as powerful weapons capable of smashing through almost any obstacle. Such Ogryn are well suited to such tactics, bellowing fiercely as they eagerly plunge into the enemy formations.

Many Ogryns of this type are also trained to respond to enemy aggression, their massive size and unrelenting brutality providing an effective counter to almost any adversary. Many can be seen patrolling the lines in between engagements, waiting for the call to arms that will end their tedious vigil. When battle does come, the Ogryn quickly charges into the thick of the fighting, often because he cannot think to react any other way. Bulwarks perform a great service to their comrades, singling out opponents their human companions would find difficult to overcome. However, this simplistic approach to combat is often the Bulwark's downfall, as the many insidious weapons and vile monstrosities of the Imperium's foes occasionally prove too much even for these mighty warriors.

## REGIMENTAL VARIATIONS

Bulwarks are useful within a variety of different units both on and off the battlefield, where their size, resilience, and strength may be put to use in the service of the Emperor. Sometimes they are fielded independently alongside a companion or minder, while at other times they fight in units alongside their Ogryn brethren. Some even find themselves consigned as body guards, though generally such a brutal Ogryn is unsuited for a role requiring such restraint, their eagerness to join nearby battles frequently leaving their charges vulnerable to attack.

Among the stern regiments of the Mordian Iron Guard and the Cadian Shock Troopers, these Ogryn are viewed more as weapons than soldiers, fighting alongside other Ogryn in strictly controlled units and segregated from the other Guard platoons when not in combat. Within such regiments discipline is paramount, and those Bulwarks who fail to abide by the many regulations of army life often spend hours in "corrective" instruction. By contrast, the more brutally-minded Ogryn within the regiments of the Catachan Jungle Fighters are more likely to receive praise for results than adherence to regulations and orders, and many quickly become valued members of their regiment. A Bulwark takes well to such attentions, accounting these men has his friends and taking a vested interest in their safety. However, the death or injury of one of his comrades is often enough to send a

Bulwark into an inconsolable fit of rage, and many enemies have felt the full force of a Bulwark's anger after harming his squad mates.

Regardless of their role, Ogryn are frequently accompanied by a human comrade into battle. These trusty companions serve to keep the Ogryn focused and from forgetting their orders, while the Bulwark's naturally strong sense of loyalty ensures their protection as the Ogryn goes to great lengths to keep them out of harm's way. These companions are generally among the hardest and fittest individuals in the regiment apart from their Ogryn counterparts, often having to survive extreme combat situations just to keep up with a Bulwark's rampage.

## ADVENTURE SEEDS

A Bulwark is an incredibly useful character for a party that finds themselves facing opponents who specialise in melee combat. A Bulwark's abilities are very effective at countering enemy charges, slaying particularly tough or vicious opponents, and keeping his allies safe within the chaos of battle. In fact, a Bulwark may be such a potent melee fighter that he can survive encounters which would kill most human soldiers, a fact the other members of the party may quickly realise and exploit. This is perfectly acceptable, as the Bulwark's ability to wade into extremely hazardous combats and then out again is the main reason these brutes are deployed on the battlefield.

However, for all his great strength, a Bulwark is not invulnerable and is at his best when supported by his comrades. Game Masters should keep this in mind when preparing an encounter that focuses on a Bulwark by giving supporting roles or additional objectives to other Player Characters during the encounter. Such tasks may range from keeping the Ogryn's flanks clear to picking off those enemies who would prefer to just shoot the Ogryn instead of risking a blow from this massive warrior.

In the same manner, a Bulwark's loyalty to his friends can be a very engaging and memorable aspect of his character for the GM to incorporate into a game. Perhaps the Bulwark is cut off from his comrades due to an unforeseen act of chance, or must rescue a squad mate from the cruel designs of enemy captors. Such situations wherein the Bulwark overcomes numerous obstacles by sheer brute force and determination in order to rescue an ally is the stuff of Ogryn legend, and will surely provide a memorable tale for everyone involved.

## SWIFT RETRIBUTION

Enemy raids are common occurrences during the many battles undertaken in the service to the Emperor, and Ogryn characters are quite useful at countering such actions until reinforcements arrive, often serving as a bulwark upon which the enemy attack breaks. During this Adventure seed the Ogryn's unit is awoken in the middle of the night by the sounds of fighting. After stumbling into their gear and grabbing whatever weapons they can, the unit is able to discern that the cause of the commotion is an enemy raid with the seeming intent of causing havoc within their own lines. Yet, as they engage their attackers, it immediately becomes apparent that the enemy has another goal in mind. The exact nature of this goal—be it assassination, sabotage, or the gathering of vital intelligence—is left to the Game Master's discretion. If the attack succeeds, the result would be disastrous both for the players and their regiment, and the squad must stop at nothing to foil the enemy attack. What's more these are no mere soldiers, but an elite unit of infiltrators responsible for numerous raids on Imperial lines and whose leader is well-known for his ferocious skill in close combat. Such an opponent should prove a fitting challenge for the Bulwark, and the slaying of such an adversary may be enough to finally give the Imperium a vital edge in the campaign.

## MAILED FIST

Bulwark's are often used as blunt instruments in combat; weapons to be thrown against the enemy with devastating effect. The Bulwark's leaders know this and have decided to deploy him in just such a manner, using his unit as part of a diversion to draw enemy troops away from another vital objective. Yet as the battle is joined and the conflict rages about the Bulwark and his comrades, they suddenly find themselves cut off deep behind enemy lines and without support from the bulk of their regiment. As the squad tries to find its way back to its allies, the players begin to discover evidence of previously unknown and disturbing enemy activity that may change the course of the conflict. It is up to the Bulwark and his unit to fight their way back through the enemy rear and save their comrades from the insidious machinations of their most hated enemy.



# GUN LUGGER

*"See this dent here? That was made by an Ork skull. By the Emperor, I'd swear some of them are as thick as a Chimera's tread guard, but that didn't stop Krund from splitting its head open like a new Grox egg, no sir. And see that warping there, by the shell extractor? Apparently that's what happens when you fire 5,000 continuous rounds without a recharge."*

—Guardsman Leisse explaining the poor state of an Ogryn Specialist's firearm to the Regimental Quartermaster

An Ogryn's ranged weapon proficiency may vary greatly from individual to individual; often coming down to the Ogryn's individual dexterity and whether or not he is able remember how to operate the firearm in combat. Regardless, Ogryns are markedly uncoordinated as a rule, and any attempts at accuracy often produce results that are mixed at best. Even the most skilled Ogryn "marksman" rarely approaches the exacting degree of precision expected of the average Imperial Guardsman. However, there are many Ogryn who derive substantial enjoyment from the mere act of firing their weapon regardless of accuracy, instead revelling in the raw destructive power in their hands as they thoughtlessly expend countless rounds of ammunition downrange.

Such Ogryns are usually are truly colossal creatures, whose bulging muscles and gigantic stature allow them to manipulate their oversized weapons as effortlessly as a normal man might wield a Lasgun while relying on their immense bulk to compensate for any recoil. Many are even large enough to fire their weapons on the move, acting like a sort of mobile fire support platform for their fellow soldiers while eagerly charging into the fray.

Once they begin firing, Gun Luggers rarely stop until they either run out of either ammo or opponents. Though the weapons they wield in combat often vary, the child-like glee these individuals exhibit for their battlefield roles is unmistakable. They are often seen sweeping their great weapons back and forth in wide arcs during a battle, grinning stupidly as they pulverise their targets with concentrated streams of high calibre fire. Most tend to lag slightly behind the other members of their unit, stopping whenever a shot presents itself and only continuing to advance at the bidding of a superior officer or when they no longer have anything at which to shoot. They are usually eager to come to grips with their foes, habitually disregarding enemy fire or any considerations of personal safety in order to discharge their weapons at

## APTITUDES AND EQUIPMENT

**Prerequisite Speciality:** Ogryn

**New Aptitudes:** Ballistic Skill, Offence, Defence, Perception, Strength, Weapon Skill

**New Talents:** Either Weapon Training (Bolt) and Weapon Training (Las) or Ripper Charge

**Specialist Equipment:** Good Craftsmanship heavy bolter or Good Craftsmanship M41 multi-laser or Best Craftsmanship ripper gun, 5 frag grenades

their targets. In addition, the expenditure of all their ammo or the occasional weapon jam is a frequent cause of wildly destructive tantrums among these trigger-happy brutes, and many choose to vent their savage rage by charging headlong into the enemy's ranks and bashing their adversaries to bits with the offending weapon.

Other members of these units often rely on the relentless fire of an Gun Lugger, advancing forward while their



## SPECIALIST ADVANCES

The Gun Luger may purchase the following Advances to enhance his own abilities and the abilities of his Comrade.

### BALLISTIC FURY

**Type:** Passive

**Cost:** 300 xp

**Effect:** The Gun Luger can wield Heavy ranged weapons that do not have the Ogryn-Proof Quality as though he did not have the Clumsy Trait. However, whenever a ranged weapon without the Ogryn-Proof Quality the Gun Luger is wielding Jams, the Gun Luger breaks the weapon in his exuberance unless his Comrade is within Cohesion to calm him. A broken weapon must be repaired with a **Hard (-20) Tech-Use Test** that requires at least several minutes before it can be fired again.

### GUIDING FIRE

**Type:** Full Action

**Cost:** 500 xp

**Effect:** The Gun Luger's Comrade lays down a trail of shots to a chosen target that the Gun Luger himself can attempt to mimic. Until the end of the Turn, the Gun Luger doubles his Degrees of Success on any Ballistic Skill Test he makes to hit the target his Comrade marked. The Gun Luger's Comrade must be within Cohesion for him to enact this Order.

large comrade empties round after round at every enemy in sight. Gun Luggers are also particularly useful among squads of other Ogryn or similarly equipped assault units, providing crucial fire support until their more "hands on" companions can close the distance to their foe. Even those armed with Ripper Guns tend to wield them to greater effect than other Ogryn, and often the newest and most reliable models within an Ogryn squad are reserved for their use.

Due to their constant exposure to enemy fire some Gun Luggers hold reputations for outstanding bravery and stalwart determination among the units they fight beside, serving as mobile rallying points and potent examples of bravery to any faltering allies. They are generally battered in appearance, their thick hides scarred and pitted from countless impacts that would have severely incapacitated an average soldier. Yet their remarkably resilient physiology often allows them to shrug off such blows without difficulty, ignoring small arms fire and shrapnel as a man might ignore the buzzing of corpse flies.

Many Gun Luggers carry other items to add to their destructive capabilities in addition to their firearms including: grenades, anti-tank bombs, incendiary devices and other simple explosives which they may hurl at enemy positions. These weapons are often quite effective in the hands of an Gun Luger, assuming he knows how to properly arm the device or remembers to use it in the frenzy of battle. Some compensate for such errors by hurling multiple charges at once or expending their bandoliers as rapidly as possible, laughing with delight as huge swathes of the battlefield erupt in fire and death. Though rarely landing where the Ogryn intends, the volatile payloads of such weapons frequently remedy any concerns regarding the Ogryn's accuracy.

## GUN LUGGER TRAINING

Gun Luggers are extremely reliant on the training they receive from their regiments, eagerly hanging on their instructors' every word regardless of whether or not they actually comprehend anything they are told. Many also participate in numerous simplified weapon drills and extensive live fire

exercises in the desperate hope of instilling some rudimentary skill into the Ogryn's thick hide. Such exercises often prove indispensable to the Ogryn on the many battlefields of the Spinward Front, serving as vaguely remembered reminders as to the proper care and handling of their weapons in combat.

As a result Gun Luggers tend to be slightly better versed in the use of their weapons than their brethren, though such a distinction may not be saying much. A rare few are even loosely familiar with the operation of a range of heavy and support weapons found within the vast arsenals of the Adeptus Munitorum and can generally even distinguish which end the projectile comes out of without too much help.

## GUN LUGGER TACTICS

In combat, the Gun Luger's immense strength allows him to effortlessly brandish weapons that would prove impossible for an unaugmented man to fire unaided. As a result, Gun Luggers often manage to compensate for any lack of accuracy with greater manoeuvrability and a relentless desire to annihilate their enemy. Some frequently choose to engage their targets at close range, charging right up to whatever they happen to be firing at without thought to the enemy fire whipping past them. Other Gun Luggers tend to believe quantity has a quality all its own, inundating every target with a withering barrage of fire regardless of distance or line of sight. In order to accommodate such tactics, most Gun Luggers frequently take extra-large ammo drums, bulky power packs, or thousands of shells set in bristling ammo belts or stuffed into cavernous, Ogryn-sized backpacks.

When more than one such Ogryn is present in the regiment they often become fiercely competitive, each individual striving to outperform his rivals by earning the most destructive reputation or achieving the greatest number of confirmed kills. Among Ogryns tasked with destroying light tanks and other armoured vehicles, such affinities are often even more pronounced, as individual Ogryns waste untold shots in their attempts to bring down the largest and most impressive kill.

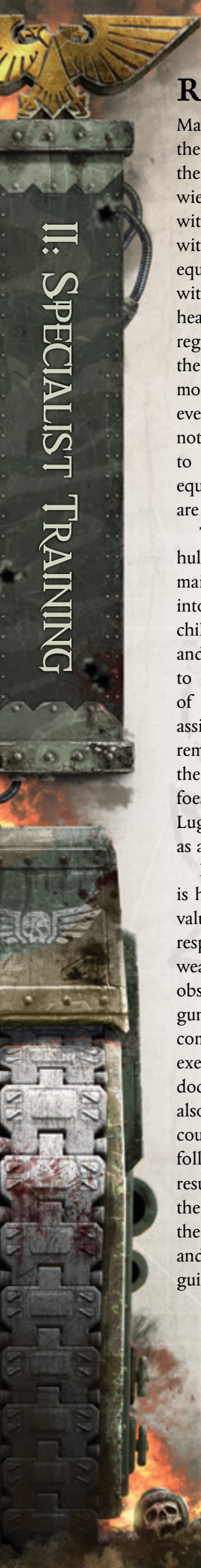

## REGIMENTAL VARIATIONS

Many regiments make use of these sorts of Ogryns throughout the numerous warzones within the Spinward Front. However the exact distribution and equipment these individuals may wield varies wildly from individual to individual in accordance with regimental doctrines and the vagrancies of supply within an Gun Luger's sector. In units where weapons and equipment are scarce, such Gun Luggers must often make do with a standard Ripper Gun or older, battle-worn versions of heavy weapons no longer fit for regular service. By contrast, regiments founded on worlds rich in industry or that find themselves deployed in a vital warzone may offer weapons more befitting their enormous stature and physiology. Yet, even within well-supplied regiments, a quartermaster may not be willing to supply new or well-maintained weapons to an Ogryn, instead providing unreliable or low-quality equipment with the half-hearted assurance that such items are still combat ready.

The Maccabian Janissaries make particular use of these hulking auxiliaries, supplying them with a variety of well-maintained weapons along with a surplus of rounds to pour into their enemy's ranks. Such regiments often consider the child-like dedication of these individuals to their superiors and the Emperor a laudable trait, going to great lengths to indoctrinate their abhuman allies to their distinct form of worship. These efforts are self-evident, as the Ogryns assigned to these zealous warriors continuously struggle to remember their daily prayers while enthusiastically defending the Emperor's domains by emptying their weapons into his foes. The regiments of the Tallarn frequently employ Gun Luggers as well, viewing their flexibility and manoeuvrability as a useful asset among their highly mobile formations.

Regardless of their unit and designation every Gun Luger is highly dependent on his human cohort, relying on these valuable companions both in and out of battle. Many are responsible for cleaning and maintaining the Gun Luger's weapon, offering its machine spirit the proper rites and observances and fighting a never-ending battle to keep the gun safe from its Ogryn handler. Others guide their towering comrades through countless training sessions and live fire exercises while repeatedly instructing them in the prescribed doctrines of sustainable fire rates. Every companion must also contend with frequent weapon jams, reloads, and enemy counter assaults in the midst of combat as they resolutely follow their massive cohort into the thick of the action. The resulting bond between these steadfast companions is among the strongest of all the human-abhuman relationships within the Guard, as each comes to learn the other's temperament and the Ogryn comes to rely on his human companion for guidance in battle.

## ADVENTURE SEEDS

Due to the types of weapons and tactics a Gun Luger often employs, such characters typically play a large part in most combat encounters as the other party members come to rely on them for supporting fire. However, when a Game Master wishes to highlight the Gun Luger in particular, it may be useful to take the Ogryn out of his support role and instead thrust the bulk of the work onto his massive shoulders. Situations where he is tasked with holding a point while the rest of the unit advances, or becomes separated and must survive unaided until help arrives all fine highlight the Gun Luger's resilience and perseverance. Such encounters should play to the character's strengths while taking into account the weapons and equipment he typically carries and challenging the player to develop new methods of portraying his role within his unit.

Another way to highlight the Gun Luger within a particular encounter is to increase the intensity of his role above and beyond its normal limits, thereby creating opportunities for previously unknown levels of extraordinary destruction. This can be accomplished through limited or one-time access to rare and destructive heavy weapons, stock piles of ammunition, or large amounts of particularly destructive war gear and specialised tools. Such a scenario, when combined with interesting and unique situations or seemingly insurmountable odds, can be a great way to let the Gun Luger do what he does best in truly spectacular fashion.

One thing for the GM to always keep in mind in such situations, however, is balance and moderation. If the enemies are too vulnerable, too numerous, or do not represent a significant threat, the encounter may quickly become boring and repetitive as the Gun Luger obliterates every enemy before him with contemptuous ease. By contrast, enemies that are too deadly can quickly overwhelm even the strongest defensive position, which can leave the Gun Luger feeling like he failed his mission or died unnecessarily. The best way to offset these and other such difficulties is to mix things up during the encounter, throwing unexpected enemy tactics, troops, vehicles, or war gear into the mix. Such unforeseen developments often force the Gun Luger to rely on his comrades and his own quick decisions in order to survive the enemy assault. If done correctly, such dire circumstances can be used to create thrilling and tense encounters that will remain with players long after the last shot is fired and the final combatant falls.

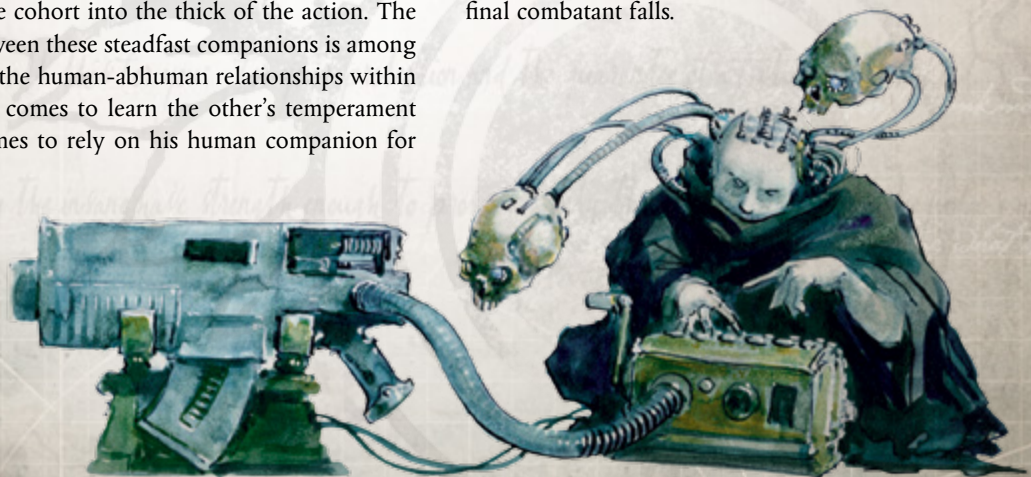

## THE OBSTINANCE OF NOD

Many of the best-known tales regarding the lumbering Ogryns describe unswerving loyalty and dedication to the Imperial cause in the defence of their comrades. In fact, such qualities are a major factor in the widespread conscription of these abhumans into the Imperial Guard as well as the Imperium's continued tolerance of these obviously divergent strains of humanity. However, with the exception of a few extraordinary instances, such examples of defiance rarely prove to be more than entertaining anecdotes.

One of the most celebrated of these occasions transpired when an Ogryn named Nod managed to rally his fellow soldiers and almost single-handedly turn the back the tide of a piratical Eldar raid. The attack occurred before dawn, while the majority of the Platoon was still asleep. The foul xenos had stealthily ambushed and eliminated the numerous sentries stationed at the edges of the camp, leaving only headless corpses behind and the Guardsmen's billets completely undefended. Their task complete, the raiders then crept silently between the hab-tents, viciously slaying and mutilating every soldier they came across while leaving the remainder to eventually awake to the unexpected horror of their companions' grisly fate. By the time the alarm was finally raised, a quarter of the platoon's members were already dead, and the rest had awoken into a nightmare of butchered comrades and a camp in panicked disarray. The Dark Eldar too cast restraint to the wind, manically falling on their victims with savage grace and eagerly taking yet more heads to accompany the fresh trophies that dangled from their gruesome murder-chains.

All seemed lost as the defenders succumbed to the furious assault one by one, isolated pockets fighting desperate, losing battles against the vile xenos raiders. Yet, just when the Guardsmen's fate seemed certain, a roar of defiance echoed from the quartermaster's tent accompanied by the sound of furious heavy weapons fire. The roar was that of Nod, an Ogryn recently assigned to the platoon. Having been sent on an errand to the Quartermaster, the massive Ogryn had arrived at his destination to find the tent deserted and the weapons awaiting the day's marshalling in pristine rows. It cannot be doubted that the Emperor was with Nod that day, as he immediately grabbed a weapon and began to fire extended bursts of high-calibre rounds into the startled ranks of the enemy. With grim determination, he continued to pour his righteous vengeance into the raiders until he had expended every round of ammunition, at which point he grabbed another gun and resumed his murderous volley. The Eldar were unprepared for the fury of this unexpected attack, and a great many fell before Nod's continuous fusillade, their cruelly barbed and bladed armour buckling beneath the relentless hail of fire.

Soon the other scattered survivors began to regroup around Nod's position, quickly arming themselves and adding their considerable fire to his own. Faced with this unexpected development, the Eldar soon retreated, taking to the sky in their sleek raiders and slinking off into the retreating blackness while leaving their numerous dead and wounded behind. Remarkably, almost half of the unit survived the attack, and a mere 27 were deemed missing following the vicious raid. For his service, Nod became a living legend among the surviving defenders, and tales and songs concerning the "Obstinance of Nod" have become common among many units within the Spinward Front.

## BIG GAME

The battlefields of the 41st Millennium are host to a wide variety of tanks and assault vehicles with all manner of arcane and deadly armaments, any of which are perfect quarry for an Gun Lugger in this Adventure Seed. In this scenario, the Gun Lugger and his unit are part of an offensive into a dense and trackless forest in order to flush out hostile forces that are using the undergrowth as cover. However, a lone enemy vehicle is launching multiple deadly surprise attacks before disappearing quickly back into the brush, severely hindering the Imperial advance. As a result, the Gun Lugger and his unit have been tasked with hunting down this roving war machine and halting its deadly rampage before any more damage is done. This scenario should play perfectly to the Gun Lugger's strengths as it both draws inspiration from the Ogryn's tribal hunting culture and takes advantage of his ability to fight both the vehicle and any supporting units that may accompany it. Whether a crude Ork wagon, a sleek xenos attack craft, a vicious walker, or some other unique and deadly heretic tank, the enemy vehicle will surely sport lethal armaments of its own and should serve as a challenging encounter in return for hours trekking through the thick, jungle vegetation. Perhaps the individual that piloted the vehicle with such cunning and skill could even serve as the encounter's thrilling climax following the tank's demise, emerging from the tangled wreckage to reap his terrible vengeance on the party.

## REARGUARD

This Adventure Seed takes advantage of the Gun Lugger's penchant for unleashing a torrent of fire on his enemies while acting as a mobile support platform. In this scenario the Gun Lugger and his unit must infiltrate a key enemy fortification or stronghold, and destroy it from within by placing demolition charges at key points within the structure. However, the facility is rather large and the unit will need time to identify and place their destructive payloads where they will do the most damage. While the rest of his comrades are so engaged, the Gun Lugger is assigned to cover the squad's escape route. However, enemy forces within the structure managed to get off a distress signal to a nearby enemy formation, which has mobilised to mount a counter-attack on the Imperial forces and entomb them within their objective. Now the Gun Lugger must hold off increasing numbers of enemy soldiers as his comrades race against time to finish their mission before their window of escape closes for good. To make matters worse, a few enemy defenders have survived the initial onslaught. Confident that friendly units will soon arrive in force, these surviving enemies are committed to ensuring that none of the loyalist soldiers make it out of the structure alive.

# FIXER

*"Alright lads, ante up, ante up. Gorbo, you Emperor forsaken dog! How'd you come across that kind of clink? Oh you know better than that, mate; Havord ain't the type to let that kind of thing lie, mark my words. No worries though, here's what you're gonna do..."*

—Malgoy the Ratling, Acting Sergeant of the 304th Cadian Auxiliary Rifles

The majority of humanity knows little to nothing of Ratling culture, the common citizen often raised with an unshakable belief in the purity of the sacred human form and having never ventured off of their birth world. This tends to hold true within the Imperial Guard as well, and those Guardsmen who are familiar with these diminutive humanoids generally only concern themselves with popular rumours and derisive legend. Yet to some Ratlings, the ties of culture, history, and shared ancestry with their human allies are indispensable.

Occasionally, a Ratling with a particular mind for leadership and a protective eye towards his fellow Ratlings, will take it upon himself to act as a mouthpiece for his squad when interacting with their comrades in the Imperial Guard. Of course, such Ratlings are still Ratlings, and their usual method of protection and advocacy is rather unfamiliar to most of their non-abhuman comrades. Using a combination of charm, guile, and sheer false-bravado, this sort of Ratling makes certain that the well-being of those he considers his charges is ensured, regulations and chain of command be damned. While this can mean a great deal of trouble for a supply officer unfortunate enough to stand between a Fixer and the materiel he intends to provide for his men, such actions earn the Ratling the undying devotion of his comrades. In time, as a squad of Ratlings becomes ever-more integrated within the regiment to which they are attached, the Fixer may broaden his notion of who falls under his protection, even going so far as to take human guardsmen under his personal purview. By this time, such a Ratling will likely earn himself a great deal of influence within the regiment.

In order to fulfil these self-appointed duties, the Ratling must possess exemplary abilities when it comes to social situations, often employing a profound understanding of social tactics and diplomacy, as well as a perceptive mind and a keen intuition. Many possess a shrewd eye resulting from countless interactions and negotiations with other units, and such individuals are often behind the machinations of a Ratling unit's various smuggling and/or illicit gambling activities.

## APTITUDES AND EQUIPMENT

**Prerequisite Speciality:** Ratling

**New Aptitudes:** Agility, Ballistic Skill, Fellowship, Finesse, Leadership, Intelligence, Social

**New Talents:** Either Combat Sense and Polyglot or Ratling Requisitions

**Specialist Equipment:** Good Craftsmanship long-las with telescopic sight or Good Craftsmanship sniper rifle with telescopic sight, chameleoline cloak, cooking supplies

Outwardly gregarious and jovial, they often play things close to the vest—or under it—and rarely make their true feelings known even to their closest companions. It's not that they don't trust the other members of their unit, instead they believe such honesty is bad for business, while the less their companions know, the less they may have to deny later. Many are also exceptional judges of character, their numerous experiences of bending the truth giving them exceptional insight when it comes to reading people or spotting deception.

The shrewd and calculating mind of this sort of Ratling is often well suited for battlefield command, where quick decisions and snap judgments can mean the difference between life and death. Further, their knowledge of their mates and easy familiarity with their habits and abilities often allows him to choose the right comrade for any job and to know when to push his men and when to exercise caution. His self-appointed role as protector also serves his squad well in battle, ensuring that a Fixer will never needlessly put any member of his unit into harms way if he can help it. These Ratlings even take it upon themselves to personally brave enemy fire in order to rescue comrades from certain death at the hands of their foes, and many a foe has felt the bite of a Fixer's blade while attempting to kill one of his companions.



## SPECIALIST ADVANCES

The Fixer may purchase the following Advances to enhance the abilities of his Comrades.

### HELPING HANDS

**Type:** Passive

**Cost:** 300 xp

**Effect:** The Fixer gains an extra Comrade. He can select this Advance up to a number of times equal to his Fellowship Bonus. See the **Multiple Comrades Sidebar** on page 55.

### BRAVADO AND BLUSTER

**Type:** Passive

**Cost:** 500 xp

**Effect:** When the Fixer makes a Charm, Deceive, or Intimidate Test while assisted by one or more Comrades, he gains a +10 bonus for each Comrade assisting him.

### FEIGNED FLANK

**Type:** Sweeping Order (Free Action) (see **Sweeping Orders** on page 110)

**Cost:** 300 xp

**Effect:** The Fixer can have any number of his Comrades within communication range participate in this Order. At the beginning of a Combat Encounter, so long as he is not Surprised, the Fixer may make a **Difficult (-10) Deceive Test** with a +10 bonus for each Comrade participating in this Order, Opposed by each enemy's Scrutiny. Each foe who loses this Opposed Test suffers a penalty to his Initiative equal to the number of Degrees of Success by which the Fixer won the Opposed Test.

During an engagement these Ratlings often seem to be everywhere at once, lending encouragement and support to those who need it and braving enemy fire to embolden his men in the face of the enemy. Many are gifted tacticians, deploying both guile and cunning against their foes in the form of timely feints and flourishes disguised and executed with an ease that often belies their complexity. Others may be highly skilled combatants in their own right, having survived countless battles alongside their comrades. These soldiers put their skills to good use ensuring the safety of those around them while making the enemy pay a heavy toll in blood for every attempted advance.

Yet some such Ratlings are not nearly so dramatic in their role and are often indistinguishable from their comrades except for the profoundly weary look in their eyes and the kindly words on their lips. These Ratlings serve as a type of moral compass for their units, and often look after their comrades with an almost paternalistic air. With wise words, witty anecdotes, and the ability to remember every name, detail, and exploit of their past and current squad mates, such individuals garner great respect from their comrades and are considered the heart and soul of their unit.

## FIXER TRAINING

Few Ratlings would ever choose to take responsibility for their comrades in the way that a Fixer seems to do. Though experience, reputation, and ability all factor into a Ratling's place amongst his brethren, ultimately the path of the Fixer requires a level of personal commitment that makes it a rather rare.

Often such Ratlings will be among the more experienced members of a unit, having faced and overcome during their years of service, many of the dangers that still await their squad

mates. Such experience also earns them a level of prominence among their peers. Some are the survivors of previous campaigns and choose to adopt this rather paternalistic attitude out of a desire to save their new comrades from the fates of the former ones. Others may instead have experienced a truly life-changing event among the screams and prowling death of the battlefield that inspired them to take on such responsibilities. Some Ratlings simply spend so much time instructing new recruits and dispensing wisdom or advice that they internally assume the role as a matter of course. A callous few even see leadership of their unit as an opportunity to enhance their own status within a regiment, though such motivations rarely inspire the loyalty of their fellow Ratlings.

## FIXER TACTICS

Ratlings are a shrewd and cunning people, and those that rise to a position of influence within their society are able to adapt to nearly any situation that may arise during the course of inter-unit politicking. This most frequently comes about when one Ratling takes it upon himself to act as a mouthpiece for his people within the regiment to which they are attached, acting as a spokesman and taking initiative on behalf of his people. They often, handle the numerous arrangements and trade negotiations related to his unit's various shady dealings and underhanded endeavours. In return a Fixer can expect the gratitude and favour of the rest of his comrades, many of whom consider it a matter of pride to ensure the unit's plans go off without a hitch.

Some such Ratlings form intricate networks of contacts and go-betweens in their affairs, running both their legitimate and clandestine operations casually and efficiently. Others prefer to employ a more personal touch when it comes



to their various dealings, ensuring the outcomes they wish through the application of tact, subtlety, and manipulation, all masked by a seemingly charming and expansive nature. Yet this kindly demeanour often belies the callous ruthlessness with which these individuals ensure the safety and security of their unit from all manner of threats, both on and off the battlefield.

In battle, these sorts of Ratlings often put the same skills to good use, directing their comrades in cunning and devious actions against the Emperor's foes. Enemy units often find themselves caught off guard by deadly ambushes or ingeniously deployed crossfires, separated from their allies and support while precise sniper fire cuts them down one by one.

Such tactics and exploits come naturally to such Ratlings, their ability to read and manipulate people, combined with their forethought and guile, allowing them to lead their men forward in feats of bravery and heroism. Those who are versed in such topics may even borrow tactics and wisdom from former commanders, myths, or the inspirational stories of the Divine Saints and great Warmasters from Imperial history, using any available resource at their disposal for the benefit of their comrades. Regardless of their methods, these exceptional Ratlings are natural leaders, and many soldiers both human and Ratling alike, owe their lives to the actions of these cunning sorts.

## REGIMENTAL VARIATIONS

Fixers can be found in many regiments within the innumerable ranks of the Imperial Guard, often arising from units of hardened Ratling veterans. Other times a Fixer steps forward because his unit is part of a Regiment with hostile attitudes towards their diminutive allies and who view their unreserved humour and seemingly lax discipline as qualities unbecoming a true soldier of the Imperium. Occasionally such individuals also emerge following a Ratling unit's deployment within an exceptionally deadly warzone for an extended period of time, the survivors taking it upon themselves to instruct the new recruits and take them under their wing.

This occurrence is strikingly noticeable in regiments drawn from the Imperium's many death words such as Catachan or the harsh climates of Tallarn. These forces are often deployed in a variety of unforgiving environments and as a result often suffer a high mortality rate due to the many threats encountered there. In response to these conditions, the Ratlings who find themselves fighting alongside these warriors often band together to increase their odds of surviving such harsh environments. Fixers are often the glue that holds such groups together, pooling resources and utilising their skills to secure vital supplies from neighbouring units, while ensuring their unit's continued safety.

To his fellow Ratlings, the Fixer is a comrade without equal, often ensuring his companions remain well-supplied and comfortably provisioned whenever possible. This high regard with which his peers hold him often translates over to the battlefield where the rest of the squad looks to him

for guidance. Often the Fixer holds the dual role of sergeant if the unit has any say, or the Ratling promoted to sergeant will take it upon himself to adopt the mantle of Fixer when outside of combat. However, even the officers who oversee squads of Ratlings would do well to at least acknowledge a Fixer's position in the unit since his support is often essential to squad discipline and morale.

Any competent Company Commander within a regiment that includes a Ratling squad is often either directly or indirectly aware of the Fixer's presence, as Commissars routinely crack down on all manner of infractions and minor offences. Yet, despite the well-known illicit nature of Ratling recruits, a Fixer's unit is often relatively free of major violations and frequently holds a record of exemplary performance and distinction in battle. Commanders who recognise the value of such things often forgo much of the mandated discipline when it comes to such units in favour of a mutual understanding and an unspoken policy of limited tolerance. Yet there are those commanders, so passionate in their desire for order and discipline, that they focus all their efforts on catching the ringleader in some real or imagined act so that they may finally bring the wrath of the Emperor's judgment down upon them. Such individuals rarely uncover the incriminating evidence they so desperately crave, however, as a skilled Fixer knows exactly when to push his luck and when to utilise discretion.

## ADVENTURE SEEDS

A Fixer's first duty is to his squad and to his fellow Ratlings in particular. This often means that his every action reflects a deep sense of duty that serves him well when surrounded by the confusion of battle. As a result no Fixer ever willingly abandons any member of his squad, and most will go to any lengths, up to and including defying his superiors, to keep a squad mate safe. This unswerving devotion is a useful attribute to a Game Master wishing to run a session that focuses on a Fixer and can frequently be exploited to create some truly tense and memorable moments.

However, when running such a session, it is important to give the Fixer a valid reason to risk his life or go out on a limb and rescue an imperilled comrade. While each possesses a strong sense of moral obligation, they are also Ratlings and will not risk themselves and the rest of their squad without cause. Most are practical leaders and, if faced with a no-win scenario, a proper Fixer would be justified in making sure as many members of his squad survive by withdrawing from conflict as opposed to pressing on and relying on divine fortune. Therefore a GM must ensure that he gives the Fixer choices during the scenario that play towards or against his personality and cultural obligations, forcing him to make decisions that will ultimately help define and develop the Fixer as a character.

Another interesting wrinkle involves giving the Fixer orders during the conflict which, though logical from a commander's lofty point of view, would require a Fixer to betray his principles. Such choices often prove to be turning points in a character's development, as the Fixer must decide whether to betray his squad or disobey his orders and, by

proxy, betray the Emperor. However, the fortunes of battle are rarely so simple, and a clever Fixer may find a way to accomplish his mission while preserving his squad's integrity, thus ensuring the Player Characters survive to fight the enemies of the Imperium another day.

## THE JAWS OF DEFEAT

The struggle for dominance within the Spinward Front is marked with stalemate and deadlock, with every victory and conquest almost immediately countered by defeat and retaliation elsewhere. This Adventure Seed demonstrates this unending cycle as the party's initial gains turn into a desperate fight for survival in the face of enemy retaliation. In this scenario the players are advancing in the wake of a successful armoured push against the barbarous Orks, sweeping aside all resistance in their path. However, the advance soon arouses the ire of a nearby Warboss with aspirations of advancing himself within Waaagh! Grimtoof. The Ork launches a massive counter-attack that catches the extended Imperial advance off guard and threatens to turn the victorious assault into a crushing defeat. Now the Fixer and his squad are faced with disaster as their regiment is caught within a rapidly shrinking pocket of defensible terrain; be it a long abandoned hive spire, a densely wooded hilltop, a mysterious ruin, or some other similar location. As the sun crests the horizon and the fearsome Warboss himself prepares to mount the green tide's final push, the Fixer must decide whether to attempt a risky break out or try and hold his increasingly tenuous position until reinforcements arrive.

## CITY OF THE DAMNED

Support specialists' unique talents and skills often mark them as candidates for a variety of covert missions within the many warzones and contested planets of the Spinward Front. For Ratling units, their predilection for stealth and renowned marksmanship capabilities make them ideal for infiltration missions, scouting patrols, and the elimination of targets within seemingly impregnable positions. The following Adventure Seed is one possible setting that incorporates all of these and more, as the Fixer and his unit must infiltrate a city that has long since fallen to the heretical forces of the Severan Dominate and is now a vital staging area for its traitorous legions. The Fixer's mission is to gather intelligence on the mysterious commandant of this city and, if possible, remove this deadly threat to the region permanently. In order to accomplish his mission, the Fixer and his squad will be forced to navigate the ruins of the fallen city, encountering many difficult tactical decisions in order to accomplish their goal. In addition to the physical well-being of his comrades, he must also safeguard the spiritual and moral health of the other members of his unit after his squad discovers a band of supposed "faithful loyalists" residing within the ruins. Now comes the true test of the Fixer's abilities as he struggles to accomplish his mission while surrounded by allies whose very survival raises serious questions regarding their true allegiance.



# LONGSHOOTER

*"Emperor of Mankind, make me an instrument of your divine will and guide my hand in this task set before me. For I have become death, destroyer of foes."*

—Variation on the Litany of the Assassin common among Imperial Snipers in the Spinward Front

The numerous Ratlings that fight within the inexhaustible legions of the Imperial Guard are recruited first and foremost for their capabilities as marksmen, each able to their routinely hit their targets with natural ease. Due to these abilities such units are frequently deployed alongside the regiments of the Spinward Front, and many superior officers choose to tolerate their overly gregarious ways and seeming disregard for protocol in exchange for such valuable skills. Yet, whether or not they are willing to admit it, every soldier who serves beside these diminutive abhumans is grateful for the sharp retorts of their long rifles echoing across the battlefield.

However, even among squads widely renowned for their exceptional accuracy, there are certain prominent individuals who demonstrate such a high degree of precision and skill that they easily surpass the other members of their unit. The accomplishments of these incredible marksmen are truly a marvel as they consistently make seemingly impossible shots despite every obstacle and battlefield condition imaginable. As a result of these prodigious skills, as well as the knack these Ratlings display for hitting their target no matter the odds, many soldiers often jokingly nickname such individuals "Longshooters."

No matter the size of their target, no matter the distance or degree of difficulty, these Ratlings rarely miss their mark. In fact, the improbably high degree to

## APTITUDES AND EQUIPMENT

**Prerequisite Speciality:** Ratling

**New Aptitudes:** Agility, Ballistic Skill, Fieldcraft, Finesse, Offence, Perception, Willpower

**New Talents:** Either Leap Up and Meditation *or* The Bigger They Are

**Specialist Equipment:** Good Craftsmanship needle rifle *or* Best Craftsmanship long-las with telescopic sight *or* Best Craftsmanship sniper rifle with telescopic sight, chameleoline cloak, magnoculars

which they succeed at even the most difficult of shots often leads their comrades to view such accomplishments as supernatural in nature or as indisputable evidence of the Emperor's divine intervention. For others, these tales of astonishing marksmanship often serve as inspirational anecdotes and rousing legends as they circulate around campfires and billets.

Longshooters are often acutely aware of the effect of their actions on the morale of the common soldier. Some make it a habit to describe particularly difficult shots or feats on the eve of battle, openly vowing to hit their mark by the conclusion of the engagement. Such individuals often succeed in their boasts, delaying their shot until the target is plainly visible in order that their comrades may fully witness the fulfilment of their oath. Others scan the battlefield for challenging shots and particularly troublesome adversaries during combat, openly aiding their allies by eliminating dangerous foes in suitably dramatic fashion.

Longshooters are a highly superstitious lot, rigidly adhering to set patterns of action or carrying charms and other lucky items to aid them in their missions. Others instead believe their abilities are a gift from the Emperor or the work of their gun's machine



12cl  
-2013-

II: SPECIALIST TRAINING

## SPECIALIST ADVANCES

The Longshooter may purchase the following Advances to enhance the abilities of his Comrade.

### COUNTERSNIPE

**Type:** Full Action

**Cost:** 300 xp

**Effect:** The Longshooter's Comrade keeps careful watch over the field, subtly alerting his partner to any oncoming danger. Until the beginning of his next Turn, the Longshooter may spend a Reaction to make a Standard Ranged Attack Action with a -20 penalty against a single foe within range who targets him with a Ranged Attack. If he kills or incapacitates his target with his Reaction, the incoming attack automatically misses the Longshooter; otherwise, the attack strikes or misses him as normal. His Comrade must be within Cohesion for him to issue this Order.

### WEAK SPOT

**Type:** Full Action

**Cost:** 400 xp

**Effect:** The Longshooter's Comrade fires a shot to weaken the target's armour so that he can pierce it with a second round placed on exactly the same location. The next time the Longshooter makes a Called Shot Action this Turn, he increases the Penetration of his weapon by X, where X is equal to the number of Degrees of Success he scores on the Ballistic Skill Test for the attack. His Comrade must be within communication range for him to issue this Order.

spirit, dutifully reciting the litanies of accuracy or devotion prescribed by their particular beliefs. To many, however, their abilities are the result of a combination of skill, preparation, and training; a belief that causes them to obsessively calibrate and recalibrate their weapon throughout countless hours of practice. Regardless, most Longshooters are extremely proud of their abilities, rarely backing down from a challenge and doggedly pursuing their quarry until either victory or death.

The rifles of these marksmen are reflections of their owners, and many bear surprising examples of artwork and customisation including trophies from particularly noteworthy targets, kill-markings, intricately inscribed litanies or filigree, and other mementos of a lifetime of warfare. The most common customisations by far pertain to the stock, trigger assembly, and optics of the weapon. Such alterations may range from custom-carved stocks, to salvaged or refurbished parts from former weapons or rare or variant models, to handcrafted innovations that fly in the face of standard regulations. Such parts are usually pilfered from Munitorum depots or won from other soldier's kits, particularly those of uniquely or well-equipped regiments who often sport one-of-a-kind gear.

Though generally outgoing and good-humoured, some Longshooters tend to be more reserved than their fellow abhumans, quietly observing with the patience of a true marksman as they take note of their surroundings and wait for the right moment to speak. Most are rarely hasty in words and often speak only when necessary, preferring to let their more talkative brethren speak for them when possible. Though they may choose to mix freely with their fellows, more often than not a Longshooter will remain slightly apart from his colleagues, their solitary contemplations often the direct result of numerous missions far removed from the company of camp. Of course, when not interacting with other members of their regiment or filling their stomachs, most can be found devotedly altering and maintaining their prized weapons in preparation for the next mission.

## LONGSHOOTER TRAINING

As with all members of the Imperial Guard, Ratling support specialists are subjected to rigorous frontline training and endless hours of target practice. However, due to their unique backgrounds and heritage, Ratlings routinely show above average proficiency with all manner of ranged weapons. Some achieve their status as Longshooters due in part to their backgrounds; their skills derived from years of stalking game on their home world or a lifetime of service in a planet's defence forces prior to their induction into the Imperial Guard. Others are just naturally gifted marksman, proving the many adages surrounding their species with every seemingly impossible shot they make.

Yet, no matter their individual circumstances, all Longshooters are incredibly dedicated to their craft; practicing for untold hours and continually sighting, disassembling, reassembling, and recalibrating their weapons. The optics of these meticulous marksmen are always perfectly sighted and their rifles are meticulously cared for and in immaculate condition. When fired, each shot impacts exactly where the Longshooter wishes without the slightest error or deviation. Longshooters treat their rifles as extensions of their bodies, and each is intimately familiar with every plate and bolt of their trusted weapon. Most are even capable of disassembling and reassembling them by touch alone.

## LONGSHOOTER TACTICS

As with most snipers, Longshooters tend to operate independently of their comrades, marching off into the unknown in order to locate the most suitable vantage from which to accomplish their mission. Once set up for his shot, a Longshooter may have to endure hours or even days of silent, motionless observation as the slightest gesture may betray his position to watching enemy spotters and jeopardise his entire mission. Like many other snipers within the Imperial Guard, they often have spotters that accompany them during missions and help

*In the Name of He who reigns on Terra, we commend the soul of Specialist Feliks to the Emperor's Embrace. Though born without the purity of the sacred form, he yet retained a righteous heart, and thus we beseech the Emperor in his mercy to pardon his transgressions of the flesh. Let all who hear of his name and the deeds recounted here be humbled, as he gave his life in service to the glory of mankind.*

*For by this Servant's hand the Arch-Heretic Salvius—may his soul be cast into the maelstrom for eternity—was vanquished and his heresy swiftly punished. Overcoming many trials and transgressions, the remembered crossed into the bounds of the enemy stronghold, moving unseen as a spirit of vengeance and making his way to the ruined spires of the once grand Imperial Basilica. However the enemy, in all his treachery, had set about a great desecration within this sacred structure, seeking to further pervert its foundations and lay the seeds of heresy within the sector. Most terrible among these were members of the Heretic's foul inner circle, dread Traitor Marines of the Great Betrayer.*

*Yet the faithful Servant was not cowed in the face of such wanton sacrilege, and set about the task of cleansing the edifice of those who would corrupt its purpose. Such was the depth of his faith and the fury in his heart, that he slew all before him, his shots never failing in their marks, smiting any who dared defy the Emperor's will. As the final traitor fell, the faithful Servant at last beheld the object of his hatred and, with a final act of righteous fury, slew the Arch-Heretic thereby ending his corruption once and for all. At their master's death, the wretched servants of the enemy set about a great lament of despair as the once hallowed basilica was rent asunder by the Emperor's Holy Might, removing all traces of the terrible blasphemy within. Yet of the Faithful there was no sign, and thus was he embraced by the Emperor so that he may stand by his side until the end of days.*

them perform their duties on the battlefield. Few bonds are as close as the one shared by a Longshooter and his companion, as each has spent countless hours lying motionless beside the other, silently enduring every hardship for the sake of a common goal. Such relationships are often expressed through actions as well as words; a subtle tilt of the head, a slight gesture, or a fleeting expression often all that is required to convey a thought or intention between soldiers for whom silence is the norm.

In combat a Longshooter team's actions closely resemble a finely choreographed routine as the spotter quickly relays enemy positions and targets to the Longshooter who then calmly places his shots in exactly the right spot to do the maximum damage. Veteran spotters often take a more active role in the combat as well, adding their own considerable shooting expertise to their partner's fire. If well positioned, and with a good field of fire, such teams are known to exact a heavy toll on the enemy as the pair's relentless fire seeks out every weakness and every opening in the enemy's tactics. Such actions are often the deciding factor in battles within the Spinward Front, as the enemies of the Imperium are quickly taught to fear the waiting death.

Many Longshooters are also frequently called upon to provide forward observation for artillery and command elements in order to ensure his superiors have a more accurate picture of the chaos of battle. From their position overlooking the carnage, they efficiently relay coordinates to waiting artillery crews and anxious platoon commanders, their extensive observation experience and keen eyes allowing them to quickly scan the battlefield for any threat or change in the flow of battle. Frequently this secondary support role means many Longshooters

are able to single-handedly direct the course of a battle as they personally orchestrate the violent deaths of any enemies that seek to turn the tide against the Imperial forces from their superior vantage point.

Some Longshooters instead choose to scan the battlefield for enemy snipers, acting as a guardian angel against these indiscriminate and often highly deadly adversaries. Tales of contests between such extremely capable marksmen litter the illustrious hallows of the Imperial Guard as both sides use every ounce of skill, knowledge, and luck at their disposal for the briefest glimpse of their opponent in their cross hairs. Despite their considerable abilities, not all such duels turn out well for the Longshooter, and many occasionally fall victim to unexpected displays of techno-sorcery and other deceitful tactics employed by their treacherous foes.

## REGIMENTAL VARIATIONS

Longshooters are the cream of the crop when it comes to Ratling marksman. Therefore, it makes perfect sense that nearly every regiment that employs these abhuman snipers will, at some point, fight alongside one of these exceptional shots. Some Longshooters spend their entire service in the Imperial Guard as the first among many talented comrades, quietly executing every order with precision and never receiving nor expecting anything less. Others may instead become legends in their own time, their squad mates toasting their health and taking heart from their remarkable exploits. Such fame has its price, however, as these individuals often find themselves selected for special assignments and assassination missions deep behind enemy lines and far removed from the rest of their squad. Ultimately

every regiment values their snipers according to their own doctrines and traditions, and it is these doctrines that determine the life—and often death—of these skilled marksmen.

Among the units of the Vostroyan Firstborn, Longshooters are particularly prized for their skill and dedication to duty, their pride and unflinching resolve in the face of adversity earning the respect of their fellows. The Death Korps of Krieg also take a keen interest in any of their diminutive auxiliary soldiers who demonstrate such skill and dedication, callously deploying them for any mission that may require the application of their unique talents. Unfortunately for these brave souls, such missions are all too often one way, as the men of Krieg are known to place greater importance on eliminating their target than the safe return of their operative; believing such a death in the service of the Emperor the greatest honour one could ask for.

## ADVENTURE SEEDS

Longshooters are keen-eyed and highly skilled marksman, exceedingly proficient at their calling and well-equipped to succeed at the majority of the shots they are called upon to make. So, unlike many other members of their party, for these characters it is often a question of if they get a clear shot and when as opposed to whether or not they can make the shot itself. They often have high stats to aid them in these efforts but must also rely on bonuses provided by equipment, placement, and planning to make any kill a sure thing. For a Longshooter, pulling the trigger should be more a reward for their efforts as opposed to a climactic event, though the palpable tension of the dice roll to determine success or failure should never be ignored.

Game Masters centring scenarios around these Specialists should place a greater emphasis on lining up the shot and knowing when to take it, rather than whether or not a shot succeeds. This can be done by adding any number of variables to a mission or given scenario ranging from inclement weather to watchful sentries, xenos technology, and even unpredictability on the part of the target and his wargear. Perhaps the enemy commander is equipped with a flickering energy field that generally protects him from harm, or is wearing Mega Armour that protects many of his vital areas from all but the most well-placed shots, forcing the Longshooter to wait until the last possible moment before firing his weapon.

Often times a battlefield is a fitting setting for such a mission, providing a sense of urgency and purpose as the Ratling struggles to get a clear shot at a high-priority enemy through the dense smoke, fiery explosions, and chaos of combat. Distractions are also a great way to build tension as the Longshooter is forced to guard his companions from unwanted enemy attention while hunting for his target. However, assassinations deep behind enemy lines, counter-insurgencies within the twisting habspires of a rebellious hive, or operations in the depths of an inhospitable and deadly jungle are all alternatives to the raucous fury of pitched battle, providing a variety of unique obstacles and unexpected challenges for the Longshooter to overcome. Further, unexpected turns of events, brief windows for taking a shot, and the required use of cooperation and planning between the unit and Longshooter are all ways of adding pressure and imparting a sense of gravitas to the moment the Ratling chooses to end his quarry's life in the Emperor's name.

## DANGER CLOSE

In order to succeed, Longshooters are frequently required to scale ruined buildings, mountainsides, and other difficult and treacherous terrain in order to achieve the best possible vantage point from which to eliminate their target. This necessity often has the added benefit of giving the Longshooter a perfect view of the enemy's positions or the terrain and obstacles his allies must cross while persecuting their ground campaign. This position, when combined with their spotting skills and equipment, make them ideal battlefield observers, enabling many to adeptly perform both roles during combat. In this Adventure Seed, the Longshooter has been assigned just such a role, taking position on a nearby rocky outcrop while his comrades clear a small and seemingly derelict, nearby hab settlement. Though the small, squat buildings appear deserted, the settlement is actually teeming with enemy soldiers waiting for the right opportunity to strike and catch the Imperial forces off guard. However it soon becomes apparent that the enemy has yet another trick up its sleeve, be it a powerful weapon, an unexpected ally, or a flanking attack. It is up to the players to discover and counter these threats through communication and coordination between the sniper and his fellow soldiers. If they fail, the entire platoon may very well perish within the enemy's deadly trap.

## A MATTER OF HONOUR

Given the size and the scope of the military actions undertaken by the Imperial Guard, even relatively minor objectives can be the focus of massive troop movements. In such cases, many separate units, or even entire platoons, might be dedicated to achieving a single goal, be it the acquisition of a valuable asset, the elimination of a strategic target, or any number of other possible objectives. Of course, in a such a limited engagement, personal relationships and rivalries become all the more important, as the strength of trust and honour can be more easily sabotaged by pride and resentment. In this Adventure Seed the Longshooter and his squad will be faced with just such an occasion. This scenario is ideal for resolving a dispute between the Player Characters and a rival squad, and can serve as a definitive end to a secondary story arc or the beginning of an internal conflict within the regiment. Both the players and a rival squad are both deployed to retrieve a single target of opportunity within a fortified base. The actual layout of the base and surrounding terrain is up to the Game Master's discretion, but both should offer a wide variety of tactical advantages and cover to exploit. However, the rival squad has resolved to unleash their ire on the Player Characters, injuring, incapacitating, or even simply wrong-footing them if at all possible. The tactics employed by the rival squad vary, based on the exact nature of the mission, but friendly fire, leaving the PCs unaided in a disadvantageous position, or leading the PCs into harms way are all likely scenarios. The rival squad's greatest concern is that their actions be deniable or unnoticed by higher authorities.

What's more, the rival squad's sniper has a special interest in the Longshooter and seeks to prove his superiority by any means necessary. It is up to the Longshooter and his squad to survive the mission intact, ultimately deciding whether enacting personal vengeance on their rivals or upholding their own honour is worth resorting to their rival's underhanded actions.

# TRAILBLAZER

*"Worst ground I've seen on this entire Emperor-forsaken rock. How in the throne's name anyone could survive down there is beyond me."*

—Captain Ianthros von Strat in response to tactical surveillance regarding his next battlefield objective

All Ratlings have a natural talent for stealth and infiltration, using their diminutive stature to their advantage in order to make their way undetected past enemy lines and sentries. These skills serve them well in their roles as snipers and sharpshooters, allowing them to select the optimum firing positions from which to complete their mission or eliminate their target. Yet there are times when achieving the optimum firing position or engaging the enemy is a rather complicated affair, requiring days of trekking through unknown wilderness, deadly terrain, or the numerous hazards of no man's land.

In such situations many units rely on the abilities of Trailblazers, highly skilled individuals are particularly adept at path finding and scouting. They excel at navigating through even the most difficult and dangerous environments, calling upon formidable abilities acquired through past experience, extensive training, or pure natural ability. Such specialists are also renowned for their stealth and



## APTITUDES AND EQUIPMENT

**Prerequisite Speciality:** Ratling

**New Aptitudes:** Agility, Fellowship, Fieldcraft, Finesse, Offence, Strength, Weapon Skill

**New Talents:** Either Catfall and Disarm *or* Surefoot Pathfinder

**Specialist Equipment:** Good Craftsmanship long las *or* Good Craftsmanship sniper rifle with telescopic sight, Good Craftsmanship shotgun, mono knife

remarkably keen sense of direction, allowing them to expose hidden paths and uncover trails leading directly into the heart of the enemy's defences.

When the call comes for a unit to move out into the brush or advance upon the enemy, the trailblazer is the Ratling relied upon to get them there. They are completely at home in the wilderness, effortlessly ghosting between trees and rocks and easily slipping undetected through whatever obstacles they may come across. Many are even able to vanish from the eyes of their own comrades, doubling back to relay information or chastise a careless guardsman in his lax adherence to stealth protocols. While their physical stature is certainly a boon to their skills, enabling them to hide in crevices and foliage normally considered too small to conceal a soldier, many must also rely on their equipment and extensive combat experience to remain undetected. Each is highly trained and proficient with many of the tools of covert warfare, readily employing Camo-cloaks, vox-links, combat webbing, noise suppressors, and anything else that may lend them a silent edge in combat.

Yet wars cannot be fought by stealth alone, and all Trailblazers eventually find themselves trading shots with their opponents. In such situations the Trailblazer's stealth provides yet another advantage as he continuously evades and outmanoeuvres his bewildered opponents, often engaging them from multiple angles in order to keep his enemies off balance and retain his advantage. Some prefer instead

to employ various traps and snares to catch their foes off guard, waiting until the enemy formation is in disarray before striking. Many even direct their squad mates and companions in flanking manoeuvres and feints, tricking their adversaries into chasing phantoms and decoys only to walk into ambushes and deadly crossfires.

In camp, these diminutive specialists are often able to pass unseen between tents, around billets, and between supply crates, evading lookouts and disciplinary crackdowns with ease. Their skill at remaining unseen and avoiding detection often serves them well in the many illicit dealings and smuggling rings most Ratlings become engaged in, and many reap substantial rewards and tidy profits from such illegal activities. Those prizes

## SPECIALIST ADVANCES

The Trailblazer may purchase the following Advances to enhance the abilities of his Comrade.

### CONVENIENT DISTRACTION

**Type:** Order (Half Action)

**Cost:** 500 xp

**Effect:** The Trailblazer calls upon his Comrade to distract his opponent, giving him a chance to dart to an advantageous position. The Trailblazer makes an **Opposed Challenging (+0) Stealth Test**, Opposed by the Awareness of each enemy within 10 metres. If the Ratling wins the Opposed Test against a target, that target counts as being Unaware of him until the end of his next Turn. His Comrade must be within communication range for him to issue this Order.

### BLATANT THEFT

**Type:** Order (Half Action)

**Cost:** 300 xp

**Effect:** The Trailblazer's partner in crime bumps into their mark, disorienting him so that the Trailblazer can slip in and out undetected. The Trailblazer makes a **Opposed Challenging (+0) Sleight of Hand Test**, opposed by the Awareness of a single target within 3 metres. If the target is Unaware of the Trailblazer, he gains a +30 bonus to this Test. If he succeeds, the Trailblazer may steal one item (which cannot be larger than Size [2]) from the target's person. If he succeeds by three or more Degrees of Success, he and his Comrade may immediately make a Disengage Action as a Free Action after undertaking this Order. His Comrade must be within Cohesion for him to issue this Order.

### NOTORIOUS PILFERER

**Type:** Full Action

**Cost:** 400 xp

**Effect:** Once per Game Session, the Trailblazer may have his Comrade produce a single, previously unmentioned item with an Availability of Common or more available from his stash of "borrowed" sundries. The Trailblazer can only acquire items that the Game Master deems reasonable in this way, and there are naturally consequences for filching from certain prominent individuals. His Comrade must be within Cohesion for him to issue this Order.

that they do not sell are often utilised in the field, allowing the Trailblazer to pass his time outside of camp in relative comfort or to more easily dispatch his foes. However, such tendencies often make them frequent targets of surprise kit inspections by disciplinary officers, pat downs by security patrols, or interrogation whenever valuable and difficult to replace items of kit mysteriously disappear. Such constant scrutiny often serves to sharpen a Trailblazer's skills, honing their talents and teaching them to always remain on guard.

## TRAILBLAZER TRAINING

While a Trailblazer's genetic heritage doubtless contributes immensely to their unique abilities, the roots of their incredible talents, as well as the circumstances that influence their development, vary greatly from individual to individual. Many develop their skills during the course of their service in the Imperial Guard; gradually honing their talents on the knife edge of combat where failure often results in quick and ignominious death. Others display a natural propensity for stealth tactics and covert warfare, abilities that set them apart from their brethren and allow them access to advanced war gear as well as the specialised training to employ it. Some are hardened and quietly efficient soldiers, their jovial demeanours and banter dropping the instant they set foot outside their own lines. Others may be jokers and tricksters, refining their skills and techniques among their mates before using them to deadly effect on the Emperor's foes.

It is unknown exactly how Trailblazers manage to maintain their bearings no matter the terrain or battlefield conditions they find themselves in. Some speculate it may be yet another genetic trait expressed in a rare few individuals. Others believe these abilities stem from long years hunting wild beasts and other, fouler things on the Ratling's home worlds or from intense survival training practised within their own regiments. Some even suggest Trailblazers actually have an incredibly acute sense of smell, and simply follow their nose to back to the regimental mess tent.

## TRAILBLAZER TACTICS

Trailblazers usually rely on covert tactics and deception to accomplish their missions, preferring to keep their enemies off balance as opposed to facing them in a fair fight. They are not cowards by any means, and each is more than willing to lay down his life for his unit and the Emperor. Rather, most Trailblazers have learned the value of attacking only when prepared to do so as well as the advantages of catching the enemy unprepared. Though such tactics are possibly a genetic predisposition resulting from their small size, more than likely they are the product of a combination of practicality and survival instincts. Despite such strategies they are still highly determined and deadly fighters, and their remarkable skills as a marksman make them more than a match for most opponents in a direct confrontation. Yet by disengaging and reengaging their targets, deploying various feints

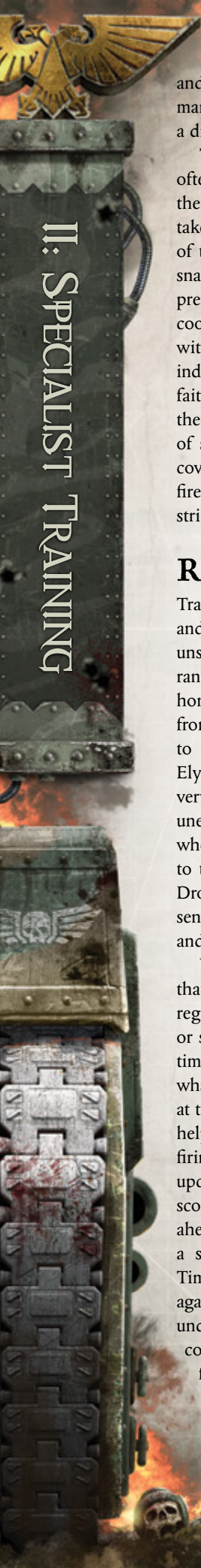

and flank marches, they are often able to take on targets many times their own number and give their fellow soldiers a distinct advantage in combat.

The actual role of a Trailblazer during such engagements is often dependent upon the abilities of the units accompanying them and the temperament of the Trailblazer himself. Some take a very hands-on approach, fighting alongside the rest of their unit and moving quickly from cover to cover while snapping off shots from unseen vantage points. Others prefer to direct from afar, calling out enemy positions and coordinating attacks between friendly squads in accordance with a larger battle plan. Still others prefer to operate independently of their fellows in two-Ratling fire teams, their faith in their own skills giving them the confidence to engage their enemy without the support of their comrades. The skills of such soldiers are incredible to behold as they dart from cover to cover, never allowing their opponent a clear line of fire and drawing the enemy's fire in one direction only to strike from another before disappearing back into the brush.

## REGIMENTAL VARIATIONS

Trailblazers are very much products of their environment and tend to flourish in regiments that operate alone and unsupported away from the bulk of the Imperium's forces. The ranks of the Catachan Jungle fighters are a particularly viable home for these small pathfinders, each benefitting immensely from the skills of the other and using their respective talents to great effect when deployed in conjunction. Units of Elysian Drop Troopers also find the Trailblazer's expertise very useful, as many of their units are forced to deal with unexpected surprises and terrain upon landing. At such times, when every second counts before the enemy becomes alerted to their presence and establishes an effective resistance, the Drop Troopers look to the Trailblazer's skills and innate sense of direction to lead them to their objectives quickly and without costly delay.

Yet such specialists can find a place in practically any army that fights for the glory of the Emperor. At some point every regiment must advance across an unknown stretch of territory or scout out its enemy's positions and deployments. At such times a Trailblazer is in his element, finding a route through whatever terrain and fortifications the battlefield has to throw at them. Many Rating units find such individuals particularly helpful as they attempt to make their way to the optimum firing position from which to provide support for their unit's upcoming advance. Other regiments field them as forward scouts or as part of reconnaissance teams, sending them ahead of the rest of their squads whenever they encounter a situation calling for the Trailblazer's particular talents. Time and again, despite the odds and enemy forces arranged against them, these skilled warriors emerge unscathed and undetected out of the darkness ahead, ready to lead their comrades forward and exact a bloody toll on the Emperor's foes.

## ADVENTURE SEEDS

Though they are often formidable fighters in their own right, Trailblazers require stealth and the ability to manoeuvre to operate at peak effectiveness, rarely facing their enemy directly or meeting his push head on. Rather, they prefer to give ground when attacked, reemerging to strike when unexpected or (preferably) avoiding a conflict all together unless it is part of their mission. Encounters that focus on these diminutive specialists must allow for such tactics if the Game Master really wishes to allow the character to shine. As such, GM's should give the player options to fight such battles on their own terms.

This means many such encounters may need to take place on a larger scale than those befitting the more combat specialised roles. Missions requiring navigating a series of defensive fortifications, extended navigation checks, and silently eliminating or avoiding sentries and forward scouts are all ideal operations for a Trailblazer to carry out in support of his unit's impending attack. What's more, missions that place an emphasis on remaining entirely undetected in order to better accomplish a goal or achieve an objective may also be a great way to emphasise the Trailblazer's abilities to the rest of the group as well as demonstrate the value of a methodical, stealthy advance while breaking the often all too common routine of full-fledged fire fights.

Yet, for all their stealth and subtlety, Trailblazers are as adept at holding off enemy attacks as they are at negating them. Their ability to employ and set traps and continually maintain a superior firing position, all while redeploying to counter emerging enemy threats is an immensely useful ability when a determined opponent is trying to attack a seemingly vulnerable strong point or advance into friendly territory. At times such as these the Trailblazer can prove to be an undeniably useful asset to his beleaguered comrades as his tactics of misdirection and surprise continually turn the table in the unit's favour and allow them counter everything their foes throw at them.

## OPERATION PHOENIX

This Adventure Seed is a perfect example of a mission befitting a Trailblazer's unique stealth and path finding abilities and may easily serve as a convenient starting point for a much bigger story arc. In this scenario a naval transport carrying an Imperial Officer with vital intelligence has been shot down behind enemy lines and it is up to the Trailblazer to lead his squad on a covert mission into the wilderness to discover the fate of the officer and to return the information he carries. Unfortunately for the players, the crash site is located in an area known to be swarming with savage Orks and other hostile xenos life. Yet, unbeknownst to Imperial forces in the region, a third adversary is also searching for the missing officer and plans to use his knowledge to crush the loyalist forces and drive them from the system. Now the Trailblazer and his comrades must race against time to secure the intelligence ahead of their hidden foe before crossing back to their own lines before being cut off by hordes of rampaging greenskins.

++Query Initiated++  
[Transcript Fragment 832745LXD-MXIV]  
++Authority Verified++  
++Security Clearance Aurantis XMVNC++  
Data Scrub Complete [M8384NV92]  
++Apostasy Rating Minimus++  
++Faith is All That Matters++

[Fragment Begins]

By the Emperor, how the Ratling knows where we are is a bloody mystery. We've been stumbling around this forsaken hell for days now. At first I believed our platoon to be advancing more or less to the east, but then one morning the sun either rose from the south instead of the west or else our guide became turned around during one of our routine night advances. Something in these wastes also seems to be confusing the Squad's Auspex despite Corporal Bernan's repeated recitation of the Catechism of the Machine. Yet despite all this Marinduin, our Ratling pathfinder, insists we have faith and follow him through sulphurous geysers and stinking, poisonous bogs that seem to stretch on as far as the eyes can see. Of my faith in the Emperor and his protection I have no doubt, but I'm not so sure about our guide.

[Data Lost]

Warp take the runt, he's lost I'm sure of it. We've had no contact with command or the enemy for over seven standard cycles, and the entire detachment seems to be on its last legs. Just yesterday we lost three men to painful chemical burns and another, Guardsman Yarif, to some kind of insect that burrowed into his back while he slept. His agonised screams woke us in the middle of the night, but by then there was little we could do as the creature devoured his spinal cord in order to deposit its offspring. Marinduin advised us to spread our greatcoats on the ground when we sleep and keep watch in case the terrain has any other surprises in store. But most of us are so tired from the relentless heat, and the noxious fumes that burn our throats and eyes, I doubt we'd be able to fight the heretics even if we did find them.

[Data Lost]

Every day I pray to the Emperor and his chosen Saints that this nightmare will end...

[Data Lost]

A miracle! How he did I can't say, but he was right! We have discovered the enemy position and the filthy traitors seem none the wiser. What foul powers they are employing I dare not guess, but we are moving into position now and will launch an assault as soon as our heavy weapon teams deploy on the surrounding bluffs. Soon we shall show these heretics that none can hide from the wrath of the righteous! In the Emperor's name, we shall have our vengeance.

++Transcript Ends++  
++Remaining Data Unreadable Due to External Damage to Native Storage Device++  
++Query Terminated++

## KEEP AWAY

Not all adventures require contact with the enemy, particularly when strong inter-regimental rivalries can set the stage for thrilling espionage and secret vengeance. In this Adventure Seed another regiment with a reputation for hostility towards the Trailblazer's unit has acquired something from them that the players want or need in order to continue their campaign. However, as the item or data was obtained illicitly in the first place, the Player Characters have no choice but to steal it back. Further, as full-fledged feuding is strictly prohibited within the ranks of the Imperial Guard, the Trailblazer must utilise his stealth skills while working with his squad mates to liberate their objective from their rivals without discovery or noticeable bloodshed. Nonlethal

takedowns, elaborate ruses, and bait and switch schemes are all examples of possible tactics for the players to use, and GM's should encourage creativity and planning throughout the course of the session. However, the other regiment has a long and proud tradition of outstanding valour and relentless determination on the field of battle. They are highly trained and despise the members of the player's unit, and Ratlings in particular. In fact, if made aware of the party's intentions, many wouldn't think twice about disposing of what they see as unworthy pests. However, if the Trailblazer and his allies can retrieve their objective without raising the alarm, the rival regiment wouldn't dare report the incident for fear of the stain on their reputation that would result from such seemingly petty squabbling.

# INCINERANT PRIEST

*"The fire of the Emperor's righteousness shall burn away all corruption."*

—Inscription on the wall of the Temple of the  
Imperator Incendius on Voluptua

The cleansing purity of flame is closely tied to many elements of the Ecclesiarchy in the Calixis Sector, from candles and incense burners to flammers and incinerator cannons.

Missionaries heading into the nearby Koronus Expanse are sometimes known as "Torchbearers," while a special breed of experienced Imperial Guardsmen combine their faith with a fierce love of flame weapons to become warriors of the Inquisition known as "Pyroclasts."

Firebrands in every sense of the word, these preachers are sometimes called "Incinerant Priests," referring to their predilection for flame-based weapons and their ability to ignite a blazing centre of hatred in the hearts of their allies. These priests are often found on the front lines of the Spinward Front's raging conflicts, wielding a flamer whilst exhorting the Imperial Guardsmen to greater efforts. The heavy combat in the Spinward Front causes several Imperial Guard units to suffer horrible losses or confront horrifying enemies—both traitor and alien—on the battlefield. Many Imperial Guard units that survive after taking heavy casualties have shaky morale, their courage faltering. These units need something that the Departamento Munitorum can't ship in a container—they need inspirational leadership. Sometimes that inspiration comes from the strong example of a skilled officer or from the stern gaze of a Commissar. However, in the Spinward Front, another source has stepped forward to fill that role—the Incinerant Priests who can uplift men's souls and efficiently focus their hatred upon the enemy.

Many Incinerant Priests belong to the Redemptionist cult, or are certainly aligned with that group's doctrine of furious zealotry and extreme intolerance of the Imperium's enemies. In fact, many Ecclesiarchy scholars claim that the first Incinerant Priest in the Spinward Front was a Redemptionist who journeyed to the Koronus Expanse as a missionary, and found his true calling amongst the unexplored

## APTITUDES AND EQUIPMENT

**Prerequisite Speciality:** Ministorum Priest

**New Aptitudes:** Agility, Fellowship, Offence, Social, Strength, Weapon Skill, Willpower

**New Talents:** Either Radiant Presence and Sure Strike or Litany of Condemnation

**Specialist Equipment:** Ecclesiarchy robes, Good Craftsmanship eviscerator with exterminator pack or Good Craftsmanship chainsword and Good Craftsmanship hand flamer or Pyrophoric vambrace, book of scripture



## SPECIALIST ADVANCES

The Incinerant Priest may purchase the following Advances to enhance his abilities and those of his Comrade.

### BRIMSTONE RHETORIC

**Type:** Passive

**Cost:** 400 xp

**Effect:** The Incinerant Priest's Comrade stokes the fires of hatred in the hearts of his allies, driving them on to incinerate the heretic, the xenos, and the witch. Whenever an ally (including the Incinerant Priest) within Cohesion range of the Incinerant Priest's Comrade inflicts Righteous Fury on an enemy with an attack that causes Damage, he rolls 1d5 twice on the appropriate Critical Hit Table and discards the lower result.

### BLAZING EXEMPLAR

**Type:** Half Action

**Cost:** 300 xp

**Effect:** Until the end of the Turn, whenever the Incinerant Priest inflicts Righteous Fury on an enemy, each ally within Cohesion range of his Comrade gains the following bonus: this character inflicts Righteous Fury on a result of 9 or 10 on Damage rolls until the end of his next Turn. The Incinerant Priest can only issue this Order so long as his Comrade is within Cohesion Range.

reaches of that far-flung region. Upon his return, the former Torchbearer found himself drawn to the Spinward Front warzones, and there began teaching others to follow his example and cleanse the impure with extreme prejudice.

Incinerant priests are very popular with certain Imperial Guard regiments in the Spinward Front, particularly the Brontian Longknives and the Luggnum Sewer Rats. Incinerant priests favour flammers, and especially, heavy flammers for their own personal use. In addition, many Incinerant Priests enjoy riding along with tank crews aboard the Tauros and sometimes the Salamander command vehicle. Naturally, Incinerant Priests are particularly drawn to the Hellhound flame tank and the massive Malcador Infernus—such priests are often welcomed by the crews of these tanks, considering themselves blessed by the priest's presence.

## INCINERANT PRIEST TRAINING

The flame has been a symbol of Imperial might for as long as any historian can remember. Be it the purifying flame of Imperial justice, the strident beacon in the Warp that is the Astronomican, or the roaring inferno of a warrior's weapon against the foes of Mankind. It is this third form that the Incinerant Priest takes to so readily. Most of these firebrands show exceptional zeal in the training yards of their Ministorum chapel-barracks and drive their fellows into maniacal frenzies of hatred and retribution.

The Ecclesiarchy knows the value of such men, especially when properly directed against those who would threaten the Imperium. As such, those who possess such undeniable will are encouraged, and their passion for violence and mayhem

nurtured at every turn. Given ostentatious accoutrements as a display of both their authority and their devotion—enormous armour-mounted braziers, weapons that drip with flaring promethium, and laud-hailers that project their bombastic personal prayers and exhortations—Incinerant Priests are charged by the Adeptus Ministorum to stand as a blazing beacon to light the course for those who would call themselves righteous.

## INCINERANT PRIEST TACTICS

Incinerant Priests tend towards shockingly overt displays of offensive firepower. Most firmly believe that the Emperor does not swoop in to rescue those in need, instead that mankind is the Emperor's weapon against the darkness that would consume them. As a result, many such priests take their fate and the fate of the men and women around them into their own hands, eschewing wait-and-see strategies in favour of aggressive, even reckless assaults. Their penchant for fire and flame weaponry serves them well in such actions, and they use it to great effect.

Nearly every creature in the galaxy with the capacity for self-awareness—and most that don't—fears fire, and rightfully so. Incinerant Priests use this fear to panic their foes and disrupt any semblance of order amongst their ranks. With his comrade flushed with the thrill of facing a broken and disordered enemy, their blows land with greater surety and purpose. Needless to say, Incinerant Priests tend to favour close-quarters combat, where their pyromaniacal tendencies can cause the most damage and disruption to the enemies of the God-Emperor.

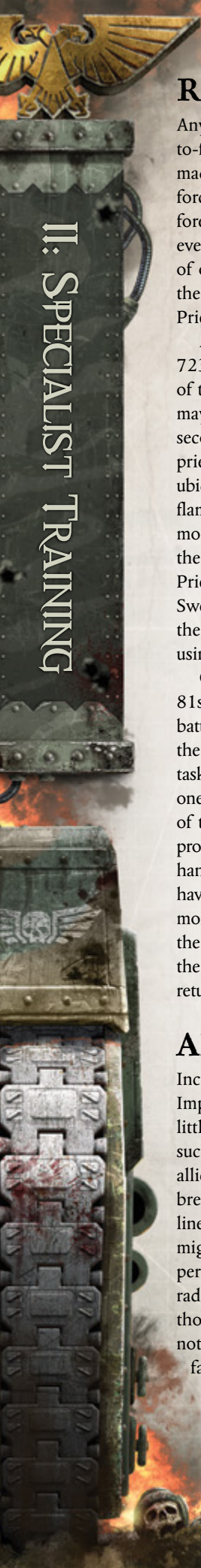

## REGIMENTAL VARIATIONS

Any Imperial Guard regiment that regularly finds itself face-to-face with their enemy can appreciate the benefit of the madman's zeal that Incinerant Priests possess. Indeed, any force that is regularly deployed to dense urban areas, thick forested or jungle warzones, maze-like trench networks, or even tight subterranean passages can take good advantage of overwhelming literal firepower. The Catachan 723rd and the Brontian 81st both enjoy the fiery talents of several such Priests while deployed to their respective battle-zones.

Among the sangui-sap trees of Koval Beta, the Catachan 723rd have been assigned two-score Ministorum Priests, and of that number at least half show the penchant for flame and mayhem that mark them as an Incinerant Priest. As they are seconded to a regiment of jungle-fighters, these bombastic priests have taken a much more defensive role. Dousing their ubiquitous braziers and torches save for the small, blue pilot flames of their weapons, the preachers have taken on a much more defensive role. When the enemy ranges too close and the stealthy Catachans are all but under-foot, the Incinerant Priests flare to action and ignite the souls of their men. Swelling forward, behind columns of prometheum-firestorm, the firebrands lead their men in a frenzied counter-charge, using fire and zeal to break the resolve of their foes.

Of course, the Incinerant Priests seconded to the Brontian 81st are given no reason to temper their ferocity on the battlefield. The 81st regiment of Longknives has been put to the task of subjugating the rebellious populace of Temeter VII, a task which seemed simple enough, but has proven a harrowing one. The 81st is vastly outnumbered by the traitorous militia of the hive world, a situation which the Brontians, with their propensity for close-quarters fighting, are ill-equipped to handle. Were it not for the Incinerant Priests the world would have long ago been lost to the Imperium. And yet, with the morale of the Longknives shored by incendiary rhetoric and the traitors terrified by conflagrations of Imperial vengeance, the planet slowly turns towards eventual pacification and a return to the Creed.

## ADVENTURE SEEDS

Incinerant Priests show a clear focus on the front-lines of Imperial Guard actions. While many might think of them as little more than pyromaniac berserkers, the true strength of such priests lies in the effect they have on both enemy and allied morale. They are often deployed in such a way as to break the psychological back of the enemy, disrupting their lines of battle and obliterating any hope their commanders might have of keeping their soldiers in order. Indeed, as pertains to their comrades, the inspiration and confident faith radiated by an Incinerant Priest is often enough to bolster those around him to incredible feats of righteousness. It is not uncommon for an Incinerant Priest to step up and take de facto command of the unit to which he has been assigned if their officer is killed or incapacitated. Such instances are, thankfully, rare but when they do come to pass, the men and women serving under the Ministorum preacher find themselves in the hands of a capable, if overly enthusiastic, commander.

## LIGHTING THE FLAME

On the planet of Thrax, a Ministorum Priest named Estopher approaches the Player Characters. The appearance of both the priest and that of the Valhallan Ice Warrior regiment he is assigned to is shocking—nearly all have burn scars, soot-covered uniforms, and singed or charred gear. Estopher explains that the Severan Dominate forces active in this warzone have a massive war machine—a Malcador Infernus—that is wreaking havoc amongst the guardsmen. “Those traitors don’t deserve such a machine,” Estopher proclaims. “The cleansing flames should be turned upon the enemies of the Emperor, not used against the faithful.”

Estopher can show the Player Characters where the Severan Dominate base is located and describe where the Malcador Infernus is being stored and serviced by the traitor forces. If the Player Character group does not include a Tech-Priest, Estopher can introduce them to a Tech-Priest with similar feelings about the enemy tank.

The Malcador Infernus should be relatively well-guarded and the Severan Dominate base should present a decent challenge to the Player Characters. At the GM's discretion, the base could be guarded by anything from a handful of soldiers and a sergeant all the way up to rogue psykers, tanks, and aircraft flying close patrols. The GM should try to present different approaches to getting inside the base—it doesn't need to be just a set-piece battle. The Player Characters could attempt subterfuge to get inside and present forged orders to take the tank, or find a way to draw off the base's defenders before attempting to make off with the Malcador Infernus.

However, the twist in this adventure seed is that the Malcador Infernus is currently under repair—the heavy pace of attacks on the Valhallan Ice Warriors in Estopher's regiment has pushed the tank far past its normal operating limits. The Player Characters are faced with a choice: they can attempt to repair the tank using a jury-rigged set of spare parts for other Severan Dominate vehicles found inside the base; they can abandon the vehicle and instead destroy it and cause as much havoc as possible in the Severan Dominate base; or they can try to find a way to haul the tank out of the base without repairs, perhaps using Sentinels or a Trojan Support Vehicle to tow it along behind them. This last option, of course, has an additional hazard in that it leaves a strong trail behind the group clearly indicating their direction of travel.

## A CAPTURED SPARK

Guardsman Steen—a forward sentry with the 868th Cadian Shock Troopers on Maesa—brings a report to the Player Characters that he observed an unusual Ork attack on a Cadian infantry platoon. The Orks were mostly composed of both Kommandos and Burna Boys, and they seemed intent on taking prisoners. Amongst the captives taken from the platoon is a Ministorum priest named Calleth. Calleth is a linchpin in the Cadian's morale, ever since a beloved veteran sergeant in the unit was slain by the Orks—if he is not rescued from captivity, it is likely that another attack by the Orks could result in a disastrous rout by the Imperial forces.

Steen has a vox-unit and is in contact with the Cadian high command on Maesa, and he relays orders to the Player Characters: they are to locate the Ork raiding party, rescue

Calleth (and the other Imperial Guard prisoners if possible), and set up a guide beacon for the Imperial Navy. The beacon is to be used for either orbital fire support or to guide in a wing of Valkyries and Vultures to airlift the prisoners out.

Getting into the Ork encampment should be a challenge; the GM should use his discretion as to the means the Orks use to guard their territory. Squigs and Grots are typically present almost everywhere in an Ork encampment, and avoiding notice can be quite difficult if the Player Characters don't take this into account.

However, the real twist in the adventure seed comes when the Player Characters locate the prisoners and get a chance to speak to Calleth. The priest has learned that the Orks have a particularly cunning leader—a Kommando Nob who has used the prisoners as bait in a trap. If the Player Characters activate the beacon and draw in the Imperial Navy, there is an Ork ship in orbit lurking just behind the local moon ready to launch an ambush.

The Player Characters must figure out a way to rescue the prisoners without the promised reinforcements and return Calleth safely to his regiment—or find another means of inspiring the Cadians' morale if they fail.

*Commissar,*

*I hope this missive finds you well—I still recall fighting alongside you against the Lost Battalion on Leprus. That was some heavy combat, to be sure!*

*I'd be pleased to assist with your project, and I do recall a situation you may find useful for your records. My crew and I had been deployed to the southern continent of Kalf, ostensibly as a stepping-stone to a mission on Kulth. However, several raiding parties of Eldar soon put paid to that plan. Instead, we were part of a hastily-organised defence force intended to secure the landing zones.*

*We had just finished preparing our Hellhound for another scouting patrol in the sand seas when a stoic, bearded man approached our tracks and waved for us to stop. He introduced himself as Kallir, a Ministorum Priest nominally assigned to the Valhallan 363rd. However, Kallir's transport had gotten confused in the chaos and he was on the wrong side of a mountain range from the Ice Warriors regiment he was meant to join. Our patrol route would take him through the pass, so I agreed to let him ride along with us on our circuit. The crew was quite pleased, since the priest blessed our Hellhound as he hopped aboard.*

*In the twisting narrows of the pass, it can be hard to discern sounds, as the reverberation of the Hellhound's engine and tracks covers up almost everything else. We didn't hear the Ork bikes until it was almost too late. A war party of greenskin bikers came roaring around a ridge, and began hammering our Hellhound with shells.*

*One of the alien rounds clipped one of my crewmen, sending him down to the floor of the fighting compartment in a pool of blood. Without hesitation, Kallir leapt into the crewman's position and seized the controls of the inferno cannon. The once-stoic Priest was a man transformed—Kallir flailed the flames from the Hellhound's main weapon around generously, matching the Ork war cries with bellowed prayers. "You want to see fire, greenskins?" he roared, ripping into the bikes with yet another blast of burning promethium. "THIS is the God-Emperor's fury made manifest!"*

*The battle raged on until we managed to fight our way clear and reverse out of the canyon. Uncharacteristically, the Orks seemed disinclined to pursue us, their numbers having dwindled greatly thanks in large part to Kallir's wild blasts of the inferno cannon.*

*We ended up taking a different route to get to the Valhallan encampment, and by the end, the crew of my Hellhound all but begged the old priest to stay. Kallir, returned to his brooding silence, refused, but he blessed us all with a soot-stained hand and hefted his singed backpack to trudge towards his destination. I am sure he found a place with the Ice Warriors, but if he ever needs a friend in the Longknives, any one of my crew—including myself—will happily volunteer.*

*The Emperor Protects,*

*—Commander Ivarr, 15th Brontian Longknives*

# PRAECENTOR OF PENANCE

*"It is with your toil and your labour that ye shall be redeemed. Through bloodshed ye shall know absolution! The blood that shall be shed shall be both that of your enemies and your own."*

—Isaiah, Praecentor of the 289th Orcan Penal legion

Priests of the Ministorum serve many vital roles in the Spinward Front, and some might say the most important is shepherding the spiritual health of the men and women involved in that conflict. The fires of war can bring out the worst in all men, and the preacher is often the last hope for a wayward soul led astray by desperate circumstances or the depths of despair. Some priests make it their mission to rescue such imperilled individuals, to take them under their wing and guide them back into the full glory of the Emperor's light. There are many who crave spiritual leadership, who thrive only when shown the way through the example of the Imperial Creed—and within the Spinward Front, the preachers that answer that call are sometimes named Praecentors of Penance.

Praecentors are not just leaders and spiritual guides; they are agitators, able to stir the hearts and minds of Imperial citizens and Guardsmen alike. Many Praecentors are skilled orators, and several have successfully swayed the opinions of those men and women misguidedly obeying the demands of the Severan Dominate. Other Praecentors use rhetoric and passion to build and control mobs, to direct the hate, the anger, the frustration of common citizens towards an individual goal—most often, the eradication of heresy or those who have been found spiritually lacking in the light of the God-Emperor.

## APTITUDES AND EQUIPMENT

**Prerequisite Speciality:** Ministorum Priest

**New Aptitudes:** Fellowship, Intelligence or Willpower, Leadership, Offence, Toughness, Weapon Skill

**New Talents:** Either Berserk Charge and Double Team or Aspire to Vengeance

**Specialist Equipment:** Carapace armour, Puritan's Wrath chainaxe or shotgun with explosive slugs, book of scripture, laud hailer

The charismatic magnetism of these priests draws those burdened with guilt and unease like moths to a flame. Praecentors in the Spinward Front often gather many troubled men and women to their side, including habitual troublemakers and shirkers from the ranks of the Imperial Guard. Some commanders welcome the opportunity to put all their ne'er-do-wells in one place. However, the Commissariat takes a much more wary view of such gatherings, and more than one argument has broken out between a Praecentor of Penance and a Commissar regarding the potential for backsliding within the Praecentor's entourage. Several regiments of the Maccabian Janissaries and the Mordian Iron Guard in the Spinward Front have welcomed the presence of a Praecentor of Penance amongst them, finding that there is great value in the Praecentor's steadying presence and oratorical skill.

The ultimate goal for many Praecentors of Penance is not just the salvation of a handful of souls that they personally care for; instead, the Praecentors look towards a day when the holy worlds seized by Ork and Severan Dominate alike are brought back into the fold of the Imperium.

Praecentors see the reclamation of these worlds—and more importantly, their populations—as a holy mission, an endeavour blessed by the God-Emperor. Such is the passion of these priests that the challenge of surviving the Spinward Front's bloody warzones seems a light burden to bear as they work towards their goal.



## SPECIALIST ADVANCES

The Praecentor of Penance may purchase the following Advances to enhance the abilities of his Comrades.

### GATHER THE PENITENTS

**Type:** Passive

**Cost:** 300 xp

**Effect:** The Praecentor of Penance gains an extra Comrade. He can select this Advance a number of times up to his Fellowship Bonus. See the **Multiple Comrades Sidebar** on page 55.

### ANNIHILATE THEM!

**Type:** Full Action

**Cost:** 500 xp

**Effect:** The Praecentor of Penance can have any number of Comrades beyond the first within Cohesion participate in this Order. As part of this Order, he makes a **Difficult (-10) Command Test** with a +10 bonus for each Comrade participating in this Order. If he succeeds, his Comrades rush forward with him and he cannot be targeted by melee attacks while making a Charge Action until the end of his Turn. Further, for every Degree of Success he scores on the Test, the Praecentor of Penance inflicts one additional hit with a melee weapon wielded by one or more of his Comrades upon the target of any Charge Action he makes until the end of his Turn.

## PRAECENTOR OF PENANCE TRAINING

Praecentors of Penance possess experience in a broad range of military and spiritual matters. They have the personal combat training of a drill-abbot, necessary given their penchant for joining their penitents on the front lines. They are not only competent warriors themselves, but given their role as a battlefield commander for the errant charges, Praecentors of Penance are often shrewd, if aggressive tacticians. Alongside their not inconsiderable combat skills, each Praecentor has received years of instruction in the rites and ceremonies of the Ecclesiarchy. They take on their penitent charges fully prepared to inflame their need for absolution into an atavistic frenzy with catechisms of zeal and hymns of resolve. Finally, many Praecentors of Penance are well-versed in the complex arts of exorcism, that they might extract confession and desire for repentance from the most misguided and stubborn transgressors.

## PRAECENTOR OF PENANCE TACTICS

None can mistake the presence of a Praecentor of Penance on the battlefield, as the fervent prayers of a teeming mass of fanatic penitents seeking absolution and the roaring exhortation of their Praecentor seems to drown out the snaps of lasguns and the thunder of battle cannon-fire. The Praecentor of Penance joins the men and women in his care on the front lines of any fight, that he can not only direct their acts of contrition, but so he might also be close at hand to witness and record the manner of their death, should that come to pass. Dying in glorious service to the Emperor, each penitent is given the final pardon they so desperately crave.

As the souls shepherded by a Praecentor of Penance seek only to return to the Emperor's light, be it through glorious action on the battlefield or a noble death at the hands of the enemies of Mankind, they are seem entirely without fear. Knowing that their past crimes have taken everything from them, a Praecentor drives his penitents into the most dangerous positions on the field, confident that they shall not falter.

## REGIMENTAL VARIATIONS

Amongst the more independent-minded regiments like the Catachans and the Elysian Drop Troops, Praecentors of Penance find little purchase. Such regiments do not harbour a strong notion of guilt and penitence and rarely do the rank-and-file of these regiments seek to redeem themselves for dishonour in such a manner as a Praecentor of Penance would deem necessary. Other, more strictly ordered regiments, such as the Mordian Iron Guard, the Scintillan Fusiliers, and the Vostroyan Firstborn, place a great deal of value on the honour and nobility of the each and every Guardsmen of the regiment, from the lowliest recruit, to the highest level of command. In such regiments dereliction of duty, failure to achieve one's objectives, and any number of other offences carry with them a harsh sentence. For this reason, the absolution offered by a Praecentor of Penance is beyond all measurable value. It should be of no surprise that the regiment that most frequently makes use of Praecentors of Penance are the Penal Legions. Amongst the prisoner-soldiers of the Penal Legions, a Praecentor of Penance offers the only salvation an ignominious death by giving them the chance to redeem themselves in through their actions. Of course, the one thing a Praecentor cannot offer them is redemption from their crimes. But while their lives are forfeit, their souls are not.

## ADVENTURE SEEDS

A Praeceptor of Penance never lacks for responsibility among the Imperial Guard. The life of a guardsman is a tough one, and never does a campaign go by, let alone a handful of minor engagements, during which tempers do not fray and pride or distrust flare into violence and disturbance among the ranks. On or off the battlefield, a regiment of Imperial Guardsmen is only as good as it is cohesive, so such outbursts are not taken lightly. Most often such incidents are the work of a Commissar, but in some cases, a Commissar is either unavailable or attending to matters above such trivialities. In these instances, a Ministorum priest may be called upon to deal with the unruly soldiers. Where it is the prerogative of the Commissariat to clean up any such messes quickly and as visibly as possible, that they might make an example out of those involved, a Praeceptor of Penance, being a likely agent of the Adeptus Ministorum, is more apt to return their fighting strength to the regiment.

Indeed, it is a common theme of Praeceptors of Penance that their concern is most often with the wellbeing of individual soldiers rather than the downfall of the enemy. As such, it is likely that any adventure specifically tied to such a priest would deal more with the regiment, its allies, and its resources than it would with those they are fighting. Perhaps the Praeceptor is given command of the remnant survivors of a veteran squad and must drive them to absolution for surviving when so many of their brothers in arms had perished.

## THE JAILBREAK

The next time they are at a major Imperial Guard depot, the Player Characters are approached by a Ministorum Preacher named Aloysus. The preacher requests to speak with the Player Characters in private, and it only requires an **Easy (+20) Awareness Test** to determine that Aloysus is uncomfortable discussing this task in public; he's hiding something significant.

Once he has a chance to address the Player Characters away from other listening ears, Aloysus confides in the Player Characters that several Imperial Guardsmen in his platoon have been placed into the depot's stockade. The guardsmen are all from the same crew of a Baneblade tank being serviced by the depot, and they are all troublemakers as well—on several discipline reports for petty theft and malingering. Aloysus explains that the guardsmen were all making good progress under his care and he feels strongly that their souls are more important than some Administratum paperwork. In addition, the Regiment is gearing up for a major attack against the Ork forces on Pertinax and the Baneblade's firepower could tip the balance in the struggle for that world. Aloysus is deeply committed to saving these men's souls, and he pleads with the Player Characters passionately.

The Player Characters have a few options in how they wish to resolve the Priest's request for aid. First, the Player Characters can try to speak with the depot's Lord Commissar and appeal for him to release the tank crew. This approach requires a number of Skill Tests determined by the Game Master; straight-out

Commissar,

*I dispatch this report to you on the behalf of Lord General Magratha Von Karlack. The Lord General has heard of your sterling reputation and wishes to extend her aid.*

*I present a formation of Imperial Guard from the world of Landunder, dispatched as part of the Achilles Crusade in the Jericho Reach. These Landrian regiments have become known as the "Drusus' Own" and in a short period of time they have gained an unusual reputation.*

*The Landrians are nearly all pilgrims, having been drafted from the nearly uncountable numbers of the faithful that have arrived through the Jericho Warp gate. Undisciplined, unused to regular Imperial Guard procedures, and lacking any kind of coherent wargear, the Drusus' Own are most commonly treated as expendable cannon fodder by the high command of the Crusade.*

*However, this view of the Landrian regiments is not held by all—the Lord General herself requested that the Munitorum assign a priest of her acquaintance, Preacher Kail, to one of the Drusus' Own regiments in her Salient for a closer look.*

*Preacher Kail saw something more in the Landrians. It is true that most of them lacked training and experience in warfare, but the Landrian guardsmen possessed great passion for fighting in the Emperor's Name. Kail felt that this passion could be harnessed and directed to turn the Landrians into a serious fighting force.*

*Under Kail's leadership, several regiments of Drusus' Own began to take on additional duties in the Cellebos Warzone. The Landrians formed burial details, volunteered to carry food and water to forward sentry positions, and tended to the wounded alongside Sisters Hospitaller. This is not to say that the Drusus' Own avoided combat—as usual, the Landrians formed up at the front lines for every assault and every push, suffering their normal high rate of losses over a two-year period.*

*The Drusus' Own served without complaint and the Imperial Guard began to treat them with more respect. The changing perception of the Landrians amongst the other regiments caught the notice of Lord General Von Karlack. The Lord General felt that Preacher Kail's example was worthy of your notice, Commissar, and she has personally directed me to find other such Ministorum preachers to try and replicate his success.*

*By the light of the Emperor,*

*Adept Castus Grendel*

Charm Tests should be Hard (–20) to Hellish (–60) depending on the Player Character's choice of words. Any other appropriate Skill Test and good roleplaying can sway the Lord Commissar's decision and release the Troopers into Aloysus' custody.

The second option is an actual jailbreak! The Game Master has many options here, depending on the Player Characters' equipment and Talents. Demolitions can be used to blow open a wall or create a distraction, orders from the Lord Commissar could be forged, or the stockade guards could be lured away by a fake call for help, just to list a few possibilities.

Once the tank crew has been liberated, they humbly thank the Player Characters and Aloysus for continuing to believe in their potential to serve the Emperor—they quickly get their Baneblade ready for combat and move out to join the assault on Pertinax.

## HEARTS AND MINDS

The planet of Maesa is nominally part of the Severan Dominate, but it is also overrun with Orks. Battling both the greenskins and the Imperial Guard, Maesa is a world running out of hope.

An Imperial Guard force on Maesa is presented with a unique opportunity—the Orks are constructing a set of gargants that, when complete, will constitute a formidable escalation of firepower. However, if the Imperial Guard marshal their strength to strike at the greenskins, it leaves the Imperial flank brutally exposed to a nearby Maesan settlement containing several Severan Dominate platoons.

The Player Characters are ordered by the regional Imperial Guard commander to escort a Ministorum Priest named Cam'ron to the Maesan settlement. Furthermore, the Player Characters are to assist the priest's attempt to sway the settlement's population through his oratorical skills.

At the Game Master's discretion, he can replace Cam'ron with an appropriate Player Character or Comrade. Alternatively, the GM can choose to kill Cam'ron during one of the assassination attempts detailed below and leave the task up to the Player Character group.

The Severan Dominate is well aware of their tenuous grasp on the settlement, and they have dispatched two assassination attempts to try and eliminate the Imperial envoy before he has a chance to sway the Maesans towards the Imperium.

The first attempt occurs after the Player Characters leave the Imperial Guard headquarters but before they reach the Maesan settlement. The Game Master should use his discretion as to the level of force that the Severan Dominate sends against the Player Characters; depending on the group's resources, this attack could vary from a few snipers to an entire squadron of vehicles. The main thing to remember here is that this attack should present a decent challenge without being overwhelming.

The second attempt occurs when the Player Characters first reach the settlement. The city is in ruins, mostly filled with revetments and huts built from the rubble. The residents scavenge from crumbling hab-blocks, and any cooking is done in covered pits. The populace of the settlement are gaunt, tired, and stretched to their limits—it is a perfect opportunity for the preacher (or the Player Characters) to turn the people of Maesa from enemy into ally. The assassins strike when the Player Characters and the priest are being served some

meagre food and water—a bomb is set in a nearby hut and activated by one of the hidden Severan Dominate agents. The Player Characters must succeed at a **Difficult (–10) Awareness Test** to notice that something strange is going on with one of the huts (no one seems to be going in or out except for the agent, who is acting quite nervously).

After the second attempt is dealt with, the Game Master must then judge the Player Characters' actions and how they have affected the mission. Failure results in a setback for the Imperial Guard, as they cannot strike at the gargants with full force. A minor success means that the Maesan settlement agrees for a temporary truce, long enough for the Imperial Guard to deal with the Orks. A great success means that the Maesans seriously consider changing allegiance.

## ONE FINAL TRY

The Player Characters are restoring their equipment at a Departamento Munitorum depot when they are approached by a Ministorum Priest named Mikhail. Mikhail is distraught—a group of forward sentries under suspicion for black marketeering has gone AWOL during the build-up for a major assault against the Severan Dominate on Letum.

Mikhail is convinced that these men, while they have been led astray, have souls worth saving. “They may be desperate men, but desperate men have a place in the Imperial Guard,” he explains to the Player Characters. Unfortunately, Mikhail has no idea where the forward sentries have gone—they failed to report for duty six hours ago at the front gate.

The Game Master should use his discretion to allow opportunities for the Player Characters to determine the AWOL guardsmen's location. Successfully making a **Hard (–20) Tech-Use Test** with an auspex can pick up the guardsman's still-active vox-beads, whilst a **Difficult (–10) Search Test** of the guardsmen's barracks reveals a badly-damaged dataslate containing a set of map coordinates, just to give two examples. Anyone checking into the guardsmen's records with the Imperial Guard commanders or the Administratum clerks reveals that these men have all been tried and sentenced in absentia and are scheduled for execution, but the files lack proper authentication for the orders.

When the Player Characters catch up to the forward sentries, the guardsmen's first reaction is to threaten violence. If the Player Characters attempt to reason with them to break the tension, the forward sentries reveal a surprising justification for their situation—they are, in fact, acolytes of the Inquisition! One of the forward sentries possesses an Inquisitional seal and claims that he and his fellow acolytes are on a mission for Lord Inquisitor Caidin, ferreting out information about a potential threat to the Calixis Sector on Sleaf Outworld, and that they are merely waiting for their contact to move them off-planet to that location.

The Player Characters have a choice—they can either accept the forward sentries at their word, or they can arrest the acolytes and pass them on to their superiors at the Imperial Guard Depot for judgement.

As to whether the guardsmen are truly acolytes of the Inquisition and whether their mission on Sleaf is real or just a ruse—that is left to the Game Master's discretion.



# PRELATE-AT-ARMS

*"The Emperor Protects... But only those who are worth his protection!"*

—Brother Edric, Prelate-at-Arms

**W**arzones like the Spinward Front can bring out the fiercest warriors from unusual places; sometimes, these warriors are found amongst the ranks of the Ministorum rather than the Imperial Guardsman to whom they minister. The presence of a Priest can be critical when the Imperial Guard must face alien terrors or the dire moral threats of treachery and heresy, chanting prayers in the midst of the most furious conflict and bolstering the faith of the men. However, some priests go a step further to inspire fervour in the God-Emperor's name; these priests find themselves compelled to close with the enemy in savage melee, clashing with the foe in close combat as the ultimate test of their faith. Those few preachers that emerge triumphant from such assaults are emboldened, their faith strengthened. Many continue to seek out similar opportunities to charge into the enemy ranks with a prayer upon their lips and a weapon in their hands.

Some in the Spinward Front call priests such as these "Prelates-at-Arms," referring to their single-minded pursuit of utterly eliminating a foe in hand-to-hand combat. Faith and fervour drive these Prelates-at-Arms nearly into a berserk state, defying any fear of death with a hearty determination to spill the enemy's blood at all costs. Lasguns and other ranged weapons (aside from a sidearm, such as a laspistol) are generally eschewed, as striking down the enemy from afar garners the priest little satisfaction. Often, the Imperial Guardsmen serving alongside the preacher are often better marksmen in the first place, further emphasising the Prelate-at-Arms's special status as a formidable force in melee.

## APTITUDES AND EQUIPMENT

**Prerequisite Speciality:** Ministorum Priest

**New Aptitudes:** Ballistic Skill, Defence, Fellowship, Leadership, Strength, Toughness, Willpower

**New Talents:** Either Combat Formation and Weapon Training (Bolt) *or* Strength in the Creed

**Specialist Equipment:** Sanctified vestments, either Best Craftsmanship bolter *or* Good Craftsmanship power sword and Best Craftsmanship bolt pistol, book of scripture, laud hailer

II: SPECIALIST TRAINING



Many of the less experienced Imperial Guard platoons regard the presence of a melee-focused priest in battle to be a lucky charm, a counter to the savagery of an Ork assault or a determined push from the Severan Dominate. Several regiments in the Spinward Front that are often deployed into combat against the bloodthirsty alien

Orks seem to attract the presence of Prelates-at-Arms amongst their ranks. The Valhallan Ice Warriors and the Armageddon Steel Legion are two such regiments, each experienced with battles against the greenskins and both highly cognizant of the value of a Ministorum priest who knows his way around a chainsword. The Calixian cult known as the Vitrian Covenant fosters a uniquely fervent hatred of Orks, and many of their members have found their way into the conflict in the Spinward Front just for the opportunity to face the greenskins in battle. Several Prelates-at-Arms are also members of this cult or adherents to a similar view of aliens, finding that the best way to extinguish such horrors from the Emperor's galaxy is to personally destroy them in a duel.

## SPECIALIST ADVANCES

The Prelate-at-Arms may purchase the following Advances to enhance the abilities of his Comrade.

### DO NOT FALTER!

**Type:** Half Action

**Cost:** 300 xp

**Effect:** The Prelate-at-Arms' Comrade calls for his allies to ignore the odds and fight on in the Emperor's name! Until the end of the Turn, whenever the Prelate-at-Arms uses the Inspire Special Use of the Command Skill, each ally affected by this ability gains an additional +20 bonus to Tests to resist the effects of Fear, Pinning, and mind-altering Psychic Powers until the end of his next Turn. The Prelate-at-Arms' Comrade must be within communication range for him to issue this Order.

### PIETY'S REWARD

**Type:** Passive

**Cost:** 300 xp

**Effect:** Whenever an ally within communication range of the Prelate-at-Arms' Comrade spends a Fate Point, he becomes invigorated by the act of pious labour. The Prelate-at-Arms may make a **Hard (-20) Command Test** as a Free Action; if he succeeds, he may issue the Righteous Oration Order until the end of his next Turn even if his Comrade has already used it once this Encounter.

Those who walk the path of the Prelate-at-Arms seem to prefer chain weapons, especially chainswords and the massive viscerator—all the better to inflict the most gruesome wounds upon their foes. Wreaking carnage in the God-Emperor's name is of paramount importance, and few weapons excel in the maelstrom of melee like a chainsword—of course, power weapons (particularly the power fist) are also valued, but these weapons more often find their way to the officer corps of the Imperial Guard than to the Ministorum.

A Prelate-at-Arms may seem to an onlooker to seek martyrdom. In truth, these priests are putting their faith to the challenge, fuelling their rage in close combat with their belief that such acts gain the favour of the God-Emperor.

## PRELATE-AT-ARMS TRAINING

Prelates-at-Arms are those men and women of the Ecclesiarchy who have spent their lives on the front lines. During their noviciate, they sought the most direct route to enlightenment, sought the simplest way to know the Emperor's truth. Such men and women, in their zeal, find one true expression for their faith and fervour—righteous battle against the enemies of Mankind. Disdaining those who would stand behind their fellows and lead from the rear, these priests would surge to the front of their battle-lines, smiting their foes and standing beside those who would fight for the cause of Mankind. It is during these times that many such preachers feel an ecstatic awakening, and thus uncover their true vocation. Seeking ever greater expressions of their devotion to the Emperor, these men and women train endlessly, mastering the arts of melee combat and becoming living symbols of the Emperor's wrath

to those around them. Their unquenchable spirit and heedless courage in the face of all the horrors of the galaxy earns such pious warriors a place alongside the Imperial Guard, so that the humble soldiers of that mighty organisation might take inspiration from them.

## PRELATE-AT-ARMS TACTICS

Prelates-at-Arms are straightforward, forthright individuals who favour straightforward, forthright tactics. Their inspiring rhetoric and unswerving faith in their own rightness does not lend itself to duplicity or tactical cunning. Instead, such individuals prefer a head-on fight, pitting the strength of their enemy against their own—and that of the men they lead. Such confrontations serve as trials by combat; each victory acts as a pillar with which to bolster men's faith, each loss a stinging reminder that the priest and his soldiers must yet prove themselves in the watching eyes of the God-Emperor.

Many Imperial commanders deploy Prelates-at-Arms where they expect their lines are weakest. In these positions, the headstrong priests are able to bolster morale, while lending their not-inconsiderable personal strength to the fight. On more than a few occasions, a particularly zealous priest has driven men in secondary and tertiary fighting ranks to abandon their positions and counter charge bodily at the enemy moments before the front line was about to collapse. While such an action might smack of hubris at the least and direct disobedience at the worst, many an Imperial officer has been glad of such a glorious sallying of his troops.



## REGIMENTAL VARIATIONS

As with many support specialists, on the surface there is little variation between the character of Prelates-at-Arms assigned to different regiments. Most men and women who master arms in the name of the Emperor possess a deep well of personal faith in their own righteousness and an unwavering certainty that the Emperor guide their hands. This is not to say that they are a homogenous lot, however. A Prelate-at-Arms is only as righteous as he is able to stir those around him to righteous action and doing so requires a rapport with such charges. For this reason, the best of these warrior priests adopt certain practices and attitudes of the regiments to which they are attached. A Prelate-at-Arms seconded to the Catachan Jungle Fighters would likely have to rein in his desire to abandon stealth and cover for the sake of glorious, honest combat. While serving with the Jungle Fighters, a Prelate-at-Arms may develop a taste for ambushes and surprise attacks, coming to believe that the Emperor gifts his soldiers with all manner of strengths, including stealth and cunning. Conversely, while assigned to a force of Mordian Iron Guard, a Prelate-at-Arms might focus more on his role as inspirer and defender of his charges. In this way, the priest best serves his regiment by keeping the men and women of the line infantry steadfast in their duty that they might hold the line against the enemy. Should that enemy press too close to the formation, the Prelate stands close at hand to counter-attack and draw their blows.

## ADVENTURE SEEDS

Few can witness the horrors of war and remain unfazed and fewer still willingly seek out the swirling madness of battle as a means to test their resolve. Such is the way of things with a Prelate-at-Arms. His faith in the Emperor is both his weapon and his armour, not only for his body, but for his soul. It is this that is most likely to get him into unique situations. Where a calculating officer might never lead his men into a suicide mission against a column of Orks so as to slow their advance on an Imperial strong point, a Prelate-at-Arms might very well see such a situation as the truest test of his faith and resolve. To the mind of such a priest, should his devotion and that of his allies prove strong enough, then they shall be the sword arm of the Emperor—their potential without limit. Should their fervour and zeal be sufficient, the Emperor shall gird them against the xenos, the Daemon, and the traitor alike, and their actions shall be guided by His hand to best safeguard His people's good works.

+++Astropathic Relay Signal Code 868-Encarmine++

*I regret to inform you that a relic of the faith has been lost in battle with the Ork hordes upon Avitohol. A preacher, Tollen D'kayne, wielded the blessed and sanctified chainsword, Red Martyr, against the alien foe, but he fell in battle against a powerful Ork warlord. His body and the blessed weapon he bore have yet to be recovered.*

*I have carried out a brief investigation into the circumstances of D'kayne's death. Records show that prior to the battle that claimed his life, D'kayne had been assigned to the Valhallan 399th Regiment. The preacher had received Arch-Cardinal Ignato's personal seal in order that he might take Red Martyr with him to the Spinward Front. As well, D'kayne's sermons to the Valhallans are a matter of record,*

*Despite my suspicions, I cannot find any Guardsmen who will condemn him as a coward. To the contrary; some of the Valhallan officers claim that D'kayne pushed for the regiment's initial attack on Avitohol and insisted on a place in the spearhead of the planetstrike.*

*Based on the changing tenor of D'kayne's sermons as the assault loomed, it is my conjecture that he began to doubt his own resolve, and perhaps he was seeking some kind of redemption by throwing himself into combat with the Orks. It took a group of mega-armoured Orks to bring him down in the end, and according to the men I talked to, the priest's final resting place lies buried deep in a massive pile of Ork bodies.*

*I have endeavoured to search for Red Martyr so that the relic may be returned to the synod with all haste.*

+++Signal Ends+++

## THE FORGOTTEN RELIC

The Player Characters are contacted by a Prelate of the Calixian synod (either directly, if the group has a connection to the Ecclesiarchy in the form of a Player Character preacher, or through an Imperial Guard officer if not)—their squad is the closest Imperial Guard force to a battle site on Avitohol where a precious sacred relic of the Ecclesiarchy has been lost in battle with the Orks. The relic is a sanctified chainsword named Red Martyr, and it was last known to be wielded by a preacher named Tollen D'kayne.

The Player Characters must first request records from headquarters regarding D'kayne's reported death during the last planetstrike on Avitohol. This requires a **Hard (-20) Common Lore (Imperial Guard)** or **Charm Test** to acquire from the Munitorum officials in charge; this can be accomplished through the vox, but the difficulty is lowered to Difficult (-10) if the group visits a Munitorum clerk in person to try and acquire the records.

Once the records have been acquired, the Player Characters now have the location of D'kayne's final battle, an otherwise undistinguished location known only as "Hill 2072" in Imperial records. According to the records, this region is thickly carpeted in corpses from both sides, and has been labelled "extremely hazardous" due to various unexploded ordnance and the high possibility of alien scavengers—Grots and Squigs—present in the area.

A small group of Departmento Munitorum officials and a Tech-Priest have a small temporary outpost in the region, dedicated to the salvage and repair of Imperial Guard vehicles and supplies from the battlefield. The Player Characters may choose to stop here for re-supply or to acquire additional resources (such as an auspex or a loader Sentinel to try to use and sift through the bodies for their prize). However, if the Player Characters do make contact with the Munitorum outpost on Avitohol, a Munitorum clerk named Shalle confides in them that he has a contact with a Rogue Trader who is interested in any special trophies that the Player Characters can recover from the battlefield. If Shalle discovers that the Player Characters are looking for Red Martyr, he'll immediately vox his Rogue Trader contact and offer the Player Characters his patron's immense influence (giving them a bonus of +60 on their next Resources check) if they instead turn over the blessed chainsword to him.

When the Player Characters find the location of Red Martyr (either through using an Auspex or simple diligent searching), the GM should strive to interrupt with an ambush or two from lurking groups of Ork Kommandos, who have been sneaking through the carnage-strewn fields for some time looking for just such an opportunity.

After dealing with the Kommandos, the Player Characters receive one final surprise—D'kayne is not dead. Instead, the priest managed to barely survive his encounter with the mega-armoured Orks and has been lingering on the brink of death for some time in an improvised shelter that was once a command Chimera. D'kayne begs the Player Characters to help him return to the Calixis Sector and offer himself to the Ministorum to pay for his heresy—it is likely that he may be sentenced to become a Penitent Engine or be transformed into an Arco-Flagellant as payment for his crimes. The Player Characters must make a choice—do they leave D'kayne to die on Avitohol, or do they bow to his wishes and return him to the judgment of the Calixian synod?

## A FATE DENIED

While on patrol of the warzones on the planet of Sinophia, the Player Characters encounter a grisly sight—a downed Dark Eldar raider skiff, surrounded by alien corpses. Amongst the carnage is the slumped form of a Ministorum priest. The preacher is dying, his body broken by the alien's cruel tortures. The priest is Castus, and he is the last survivor of the 5th Sargos Irregulars. He is barely conscious and able to speak to the Player Characters in a whisper. His platoon was ambushed and decimated by the alien raiders' surprise attack. Castus and a few other survivors were subjected to the Dark Eldar's "mercies," ended only by a desperate gamble by Castus—he had located an overlooked Krak grenade and used it to destroy the Dark Eldar skimmer. According to Castus, this all took place some twelve hours prior to the Player Characters' arrival.

Castus asks the Player Characters' to escort him back to a Ministorum shuttle at a nearby Munitorum supply point. He explains that the shuttle is only going to be on-station for a few more hours before it returns to a vessel bound for the Piety of Seth. Castus hopes that surrounded by relics of the faith, he may yet recover and eventually return to the Spinward Front to fight once again.

However, the Severan Dominate has patrols in the area as well, and the Player Characters are going to be slowed down by taking Castus with them—the priest won't survive a speedy transit. The Player Characters must race against time, evade Severan Dominate Sentinels and other scouting parties, and fight their way out of at least one ambush on the way back to the Munitorum supply point. If the Player Characters are successful in delivering Castus to the shuttle alive, the Ministorum officials aboard the shuttle award the Player Character's squad with a special blessing (restoring any spent Fate Points or possibly adding a new one at the GM's discretion).





# RECTOR ERUDITE

*“The blessed Aedemar of Ecastus penned his Liber Occlusiam Eldare in M39. In that weighty tome, the scholar mentions that such perfidious beings make extensive use of ambushes and terror attacks. In fact, if I recall correctly, the hallowed sage mentions their use of terrain such as this to their every advantage. Sir, if I may make a suggestion, perhaps we ought to prepare for ambush!”*

—Father Jarvis, Rector Erudite attaché to Commander Karantine of the Maccabian 678th

**P**riests of the Ministorum fill many roles in the Imperium; they are spiritual leaders, guiders of the citizenry, and often warriors in the God-Emperor’s name. Those that accompany the Imperial Guard into battle often fit into the latter category, but that is not to say that such preachers know only catechisms and chainswords. Instead, it is often true that such priests bring quite a bit of hard-earned wisdom and knowledge collected by the Ecclesiarchy over the millennia. Such learned priests are valued by many Imperial Guard commanders to provide additional perspective on particular battlegrounds dealing with traitors, heresy, and other moral threats.

Priests that have this kind of knowledge can lend their influence to help Imperial Guard commanders cut through the red tape and bureaucracy of the Administratum. Additionally, many priests understand additional ciphers and traditions of the Ministorum that can be of advantage to a typical Imperial Guard regiment when requisitioning gear from pious Departmento Munitorum agents or delicately translating Imperial Guard orders into a “request” for assistance from the Adepta Sororitas.

In the Spinward Front, priests with these unique skills and knowledge are sometimes known as Rectors Erudite. However, it is not just

## APTITUDES AND EQUIPMENT

**Prerequisite Speciality:** Ministorum Priest

**New Aptitudes:** Fellowship, Intelligence, Knowledge, Perception, Social, Weapon Skill, Willpower

**New Talents:** Either Polyglot and Total Recall or Confessor

**Specialist Equipment:** Ecclesiarchy robes, Good Craftsmanship bolter or Good Craftsmanship flamer, rosarius, book of scripture, book of lore

knowledge that sets these priests apart—it is also wisdom, an understanding of faith amongst the Imperial Guard, from the typical soldier serving in an infantry squad to the highly and trained and elite Storm Troopers. Rectors Erudite are famous for being able to perform complex ceremonies and rituals of the Ministorum at any moment, even in the heat of a raging battle should it be so required to inflame the faith and fervour of the men on the front lines.

The education of Ministorum Priests sent into the Spinward front is a pet project of Cardinal Cal Sutai Arran of the Calixis Synod. The Cardinal values knowledge and learning, and has worked closely with the Inquisition in the Calixis Sector dealing with such matters over the last several decades. Many of these priests are hand-picked by the Cardinal, having steeped themselves for years in ancient lore, studying mouldering texts in dusty catacombs on Shrine Worlds such as the Piety of Seth and Maccabeus Quintus. Another reason that the Cardinal is intent upon having trained and learned priests in the Spinward Front is that the Cardinal—through his Inquisitional connections—is aware more than most of the incipient moral threats posed by the Spinward Front conflict, not least among them the presence of several Chaos Space Marine warbands operating out of the Stygian Deep.

II: SPECIALIST TRAINING



## SPECIALIST ADVANCES

The Rector Erudite may purchase the following Advances to enhance the abilities of his Comrade.

### WALKING ARCHIVE

**Type:** Passive

**Cost:** 400 xp

**Effect:** When assisted by his Comrade, the Rector Erudite gains a +20 bonus to all Common Lore, Forbidden Lore, Linguistics, and Scholastic Lore Tests.

### RECORD KEEPER

**Type:** Passive

**Cost:** 300 xp

**Effect:** When assisted by his Comrade, the Rector Erudite gains a +20 bonus to any Intelligence Test to remember specific and highly detailed information from his Total Recall Talent.

### KNOW THE HERETIC; KILL THE HERETIC!

**Type:** Full Action

**Cost:** 500 xp

**Effect:** Once per encounter, the Rector Erudite may issue this Order, choose a type of enemy (such as Orks, Eldar, Chaos worshippers, or any other that the Game Master deems appropriate) and make an **Hard (-20) Common Lore, Forbidden Lore, or Scholastic Lore Test** for a Specialisation of one of these Skills that includes the chosen foe. If he succeeds, each ally within communication range of his Comrade may re-roll one missed attack per Round against the chosen foe for a number of Rounds equal to his Degrees of Success on the Test.

## RECTOR ERUDITE TRAINING

The learned priests of the Spinward Front spend years, if not decades, amongst the dusty tomes, flickering dataslates, and curled parchments of the libraries and offices of the Adeptus Ministorum prior to their secondment to the Imperial Guard. Each possesses a massive mental vault of knowledge concerning the history of the Imperial Guard, their foes, their relationships to the other Imperial powers in the Calixis Sector and the Spinward Front, and countless other subjects. Few priests attached to the Imperial Guard rely entirely on book-learning, however, and most Rectors Erudite temper their scholarly education with hard-won experience and wisdom. Their knowledge of battlefield tactics is not only earned from history texts and military strategy tracts, but from standing beside Imperial lieutenants and generals in their command posts as they order their soldiers about the field of war.

## RECTOR ERUDITE TACTICS

Within an Imperial Guard regiment to which they have been seconded, a Rector Erudite is likely the most learned man on any given subject. Even standing next to mighty generals and Imperial commanders, a Rector Erudite' education concerning military tactics and strategy often remains without peer. For this reason, such priests often act as adviser and military counsel to all ranks of Imperial Guard officers, providing their vast storehouses of learning and experience to those who would see the enemies of mankind laid low. Their knowledge of such nemeses and the tactics used to defeat them is such that the advice of a Rector Erudite has meant the difference between victory and defeat more times than history has recorded. These learned men and women always seem to know an anecdote or possess knowledge of a specific theory of military philosophy that applies to any given situation on the battlefield.



## REGIMENTAL VARIATIONS

Rectors Erudite rarely display regimental variation in their personal behaviours or physical kit. Where a priest of this sort is most likely to show a change depending on his or her seconded regiment is in the specialised nature of their studies. Most often, a priest's scholarly focus lies in areas that are less well-known to the regiment to which he has been attached. In this way, the Rector Erudite can best complement his Imperial Guard allies. If a commander finds his regiment has been deployed against an unfamiliar foe in the Spinward Front, he may well find himself accompanied by a learned scholar from the Ecclesiarchy to advise him and prepare his men for battle. For this reason, more so even than other auxiliaries, many Rectors Erudite find themselves as outsiders within their seconded regiments.



## ADVENTURE SEEDS

First and foremost, a Rector Erudite is concerned with knowledge. It is his duty to possess great storehouses of theoretical, factual, and conceptual information and to piously provide the fruit of his studies to those under whom he serves. This can lead to any number of interesting scenarios. Recovering the contents of an ancient archive from a blasted warzone would be of great importance to a preacher of this sort, especially if the contents pertained in any direct way to the Imperial Creed and the spiritual well-being of the soldiers under his stewardship. Yet, knowledge is a dangerous thing on the battlegrounds of the 41st millennium. For something more sinister, a Rector Erudite may find himself the lone member of an entire regiment who has been able to decipher a vile secret. This secret could prove to be the key to a major engagement or even the downfall of one of the many foes against whom the Imperial Guard toil in the Spinward Front. Yet when the Rector Erudite presents his information to those in command—either military or spiritual—he is met with disbelief and scorn, and perhaps even suspicion on the part of those who view too great a knowledge of the enemy as the seed of heresy. In such a circumstance, a Player Character might find himself acting the part of Cassandra and having to act on knowledge that none will believe is true.

## THE CREED PREVAILS

The Player Characters receive a data-slate from Sergeant Kellborne, leader of a squad of veteran forward sentries. The data-slate contains orders from an Imperial Guard Senior Officer familiar to the Player Characters, instructing them to assist Kellborne's squad. Kellborne and his men are attempting to discover the source of a Severan Dominate rapid deployment force mounted in Valkyries that have been harrying Imperial Guard supply lines for several weeks.

Kellborne tells the Player Characters that he and his team have located a vox-channel that the Severan Dominate forces are using to coordinate their strikes. The problem, Kellborne explains, is that the vox-channel is encrypted in a cipher that isn't in the Imperial Guard code-books for the Spinward Front.

The Player Characters can attempt several different methods to identify the Severan Dominate's cipher, with the most appropriate being a related Scholastic Lore Test. The Game Master should use his discretion to determine which methods that the Player Characters choose to employ are successful, but in the end, the cipher is identified—the outcome of the Player Character's Tests simply determine how long it takes or if there are complications involved.

The cipher turns out to be an old Angevin Crusade-era code, but its use was primarily restricted to the Ministorum during that conflict and only members of the Calixian Synod possess the key.

If the Player Characters have a Priest amongst them, he may be aware of the code and can translate it for the forward sentries. Doing so should be exceptionally difficult, at least a **Hard (-20) Ciphers Test**. Another option available to the Player Characters is a Ministorum Rector Erudite working with a nearby infantry platoon. Either the Player Characters are aware of the Rector Erudite if they have encountered him before, or Kellborne can possess that information at the GM's discretion.

The Player Characters can find the Rector Erudite easily enough, but he and his infantry platoon quickly come under attack by a number of Valkyries full of Severan Dominate soldiers. The GM should use his discretion regarding the difficulty of this fight—it should be challenging but not overwhelming.

Once the Rector Erudite and his platoon are free from the battle, he can translate the code cipher. The vox-traffic indicates that the valkyries are splitting up to attack two vulnerable targets. One is a promethium and supply depot of the Departamento Munitorum, an important link in the supply chain for the Imperial forces in this region. The second target is an isolated command post containing several senior officers of another Imperial Guard regiment (the Game Master is encouraged to make this a regiment that the Player Characters have cause to dislike or have a rivalry with for extra impact). The Player Characters must choose how they will respond to this information, as both strikes are already underway. Whichever target is warned first will have the best chance of surviving the surprise attack, but the Player Characters can, of course, come up with even more inventive solutions.

Commissar,

Greetings to you on behalf of the Order of the Valorous Heart. My Canoness has passed on to me your interest in reports from the Spinward Front regarding those of exceptional mien. I have recorded an incident concerning one such individual, in which I took part.

I was working alongside Captain Leonid of the 37th Scintillan Fusiliers. That regiment's particular tradition is to be composed of members of the nobility from Scintilla, the capital world of the Calixis Sector. Thus, I had accompanied the Captain in the course of my duties for the Orders, observing and counselling him on matters unrelated to war. Unless, like many of the nobles involved, one views the political manoeuvrings of the nobles as a form of warfare.

Also assigned to the 37th was a Ministorum priest by the name of Jarek. Like the rest of the Fusiliers, Jarek was always well-groomed, and had a patrician bearing that served him well in dealing with the privileged upper-class guardsmen he mingled with each and every day.

When the 37th was deployed to Warzone Epsilon, the Fusiliers ran into severe problems dealing with a particular Ork force primarily composed of Dethkoptaz, Ork Biker Boyz, and Stormboyz. On no less than ten separate engagements, the Fusiliers were forced to fall back from the Orks' overwhelming advantage in speed and manoeuvrability. Captain Leonid confided to Jarek his fears that the regiment would fail an eleventh time, and the priest sprang to his feet. Amongst his belongings was an old prayer book that Jarek claimed was copied from a text first written during the Angevin Crusade. Inside, Jarek located several passages describing Saint Drusus' campaign against the Yu'vath—and a particular tactical situation that was remarkably similar to the Fusilier's own.

Captain Leonid read the passages and swore then, on the spot, that Jarek had shown him divine inspiration from the God-Emperor. In the next battle against the Orks, the Fusiliers followed Saint Drusus' ancient pattern of attack. In a series of running fights, the 37th eventually prevailed and drove off the Ork force, inflicting heavy casualties upon the greenskins.

From that moment on, Captain Leonid made sure to include Jarek in every war council for the 37th Scintillan Fusiliers. Several times, the priest's learned advice helped attain victory for the Fusiliers.

Ave Imperator,

Sister Gudrun, Order Famulous, Order of the Valourous Heart

## A PROPER PRIMER

A mixed regiment containing elements of the Death Korps of Krieg, the Atillan Rough Riders, and the Armageddon Steel Legion is facing a serious threat—a legion of rogue psykers and bizarre mutants on Sisk are mounting nightly assaults on the regiment's base camp.

Morale is low and tempers are flaring between all three groups forced to work together under such circumstances, and a Rector Erudite has approached the Player Characters for help. He wants them to assist him in constructing an ad hoc amendment to the Spinward Front Imperial Infantryman's Uplifting Primer that takes into account each group's particular views on warfare and blends them together with solid Ministorum prayers against the foul witchery of the rogue psykers.

The Rector Erudite has his own expertise (primarily regarding the anti-psyker catechisms and prayers to steel one's soul against corruption), but the Player Characters should be the stars of this particular adventure—the Game Master should try to find opportunities for each player to make a contribution towards the booklet that the Rector Erudite intends to use as a tool to weld the disparate parts of the mixed regiment together before the next attack.

The time limit on the attack should be used by the Game Master as a means to keep the pace of the game on track—don't hesitate to remind the players that time is running out if things slow down.

To your honour, Commissar,

I have encountered a priest of unusual faith and skill in my regiment. In a regiment like the Janissaries, in which every soldier is quite pious by normal Imperial Guard standards, you no doubt understand how rare it is for a priest to stand out above the rest.

The Ministorum representative's name is Daviir, and he joined our regiment around eight months ago, just before we left to participate in an assault landing on Sisk. At first, Daviir did not impress me as a particularly special representative of the Ecclesiarchy—he was quiet, reserved, rarely raised his voice. These qualities did not match with the more fiery orators I had seen working with my regiment in the past.

What I discovered, however, was that wherever Daviir was on the battlefield, the guardsmen with him were an iron example of discipline and courage. The priest's stoic faith made an impression on the line soldiers, and many Imperial Guardsmen of my regiment considered him not only a good-luck charm in a warzone, but also as a friend and mentor. All of these characteristics were good, but what truly surprised me about Daviir was the depth of his knowledge.

You see, after I found that Daviir was capable with the line platoons, I asked him to serve with me in the command platoon. The rest of the officer corps of the Janissaries welcomed his addition, and we soon discovered that this quiet priest had a deep well of both faith and battlefield acumen. This came to the fore when we were beset by a host of rogue psykers and mutants during the later days of the campaign on Sisk. The enemy's unnatural powers (not to mention their disgusting appearance) constituted a significant threat to my regiment's morale—particularly for the officers. It is difficult to maintain focus on the *Tactica Imperialis* when unseen terrors are raging through the minds of your senior sergeants or when lightning consumes the heavy weapon teams you were counting on to turn the tide.

Daviir's steady chanting in High Gothic helped restore a measure of sanity to the command platoon early in the battle. His catechisms were only interrupted when he would pause to point out concentrations of enemy psykers. He had discerned these by the way their mutant minions would cluster together protectively around them. Indeed, he strengthened the will of those near him by extolling their piety and service to the Emperor.

With their witchery blunted, the psykers and their mutant slaves soon fell back before us, and the Janissaries honoured Daviir with a Maccabean Star for his valour and exceptional knowledge.

Loyally,

Colonel Cammyr, 45th Maccabean Janissaries



**FIRES  
OF  
BATTLE**



- NEW TALENTS  
& ORDERS**
- 
- NEW COMRADES**
- 
- EXTENDED  
ARMOURY**
- 
- NEW IMPERIAL  
GUARD VEHICLES**

# CHAPTER III: FIRES OF BATTLE

*"Death is the great equaliser of all men. When faced with courage, it makes Ratlings tall, Ogryns wise, and common Guardsmen noble. Only in death shall the Emperor know his own."*

—Attributed to General Angevin

**T**HE ONLY WAR Core Rulebook provides a great number of character options suitable for all sorts of characters, as befits the all-encompassing organisation of the Imperial Guard. Shield of Humanity builds on that diversity with a tighter focus on specialised troop types such as Ogryns, Ratlings, and auxiliaries from the Adeptus Mechanicus and Adeptus Ministorum. New options are made available for these unique warriors appropriate to their origins and training.

The first and second chapters of this volume offer new options for character and regiment creation, as well as new Advanced Specialities to add variant structures for character progression over the course of a campaign. **Chapter III: Fires of Battle** complements these rules by providing

additional options for character advancement and outfitting. As such, the majority of the rules in this chapter can be easily incorporated into an ongoing campaign with an established regiment, but can also be used in the creation of a new regiment.

This chapter begins with a variety of new Talents, many of which are unique to the abhumans and auxiliaries that are the focus of **SHIELD OF HUMANITY**. These Talents are designed to showcase the unique capabilities and special training of each of these character types. A number of further Talents are intended for use by other Guardsmen who can expect to interact with such individuals.

On top of the new Talents, this chapter has within it a number of new Orders representing the unique training doctrines drilled into these specialists. These Orders give Player Characters of the appropriate Speciality more options for their Comrades, allowing them to demonstrate the power of their variant training on the battlefield. The versatility of Comrades is further enhanced by rules for new Comrade Types, such as Ogryn and Ratling Comrades for abhuman Regiments, and various patterns and load-outs of Servitor Comrades used by Tech-Priests and the Crimson Guard.

Finally, this chapter includes an expanded armoury and a number of new vehicles found in the arsenals of the Imperial Guard. Many of these options are specially tailored to suit the needs of specialists from this volume, but there are armaments and other equipment suitable for all character types.



# NEW TALENTS & ORDERS

*"Da Sergeant Major asked me what my job was, an' I said it was to, uh, do what I was told. He said I was a genius and gave me another medal. I likes da Imperial Guard!"*

—Nork Deddog, Ogryn Bodyguard

The Talents and Orders presented in the **ONLY WAR** Core Rulebook cover a wide variety of abilities and training that Guardsmen can display. Unlike Skills, which each cover a broad range of applications and uses, Talents and Orders represent very specific abilities and functions. Given the incredible diversity of the Imperial Guard, even before factoring in unusual or exotic units such as abhuman or auxiliary regiments, it is of course impossible to cover all the different sorts of training and specialities that could be imparted unto a Guardsmen in a single list of Talents or set of Orders.

Many of the Talents included in this section are intended to be taken by certain character types, such as the various Ogryn or Ratling specialities. Others are intended for use

by Guardsmen or other sorts of specialists who have cause to interact with or fight alongside such characters. As such, many of these Talents may not be applicable to every situation a character may encounter, and should be reserved for those characters who most benefit from such unique capabilities.

The new Orders presented here are also intended for use with the specialists who are the focus of this volume. These Orders are of most use to those who have undergone the unique training appropriate to their type, and therefore common Guardsmen are advised to either take the appropriate Advanced Training Specialities or avoid these new Orders. Some of these orders are especially demanding, and require not only an appropriate specialist to issue them, but also a comrade trained in how to respond. New Orders begin on page 110.

## NEW TALENTS

This section of Shield of Humanity introduces new Talents for **ONLY WAR** characters. As with the Talents included in the **ONLY WAR** Core Rulebook, each Talent presented here lists two associated Aptitudes and might have Prerequisites, which a character must meet before selecting the Talent. The new Talents presented in this chapter are purchased just as those on page 136 of the **ONLY WAR** Core Rulebook.

TABLE 3-1: TIER 1 TALENTS

Talent	Prerequisites	Aptitude 1	Aptitude 2	Benefit
Brute of Burden	S 45	Strength	General	Character can carry larger loads and forced march for longer.
Ears to the Ground	Commerce, Perception 30	Perception	Social	Character gains a bonus to trade or barter goods and avoid official notice.
Initiated Maintenance	Common Lore (Adeptus Mechanicus) +10	Ballistic Skill	Tech	Reduces Jams and Overheating.
It Not So Dark	Ogryn, Willpower 40	Willpower	General	Reduced effects from "But It Dark in Dere" Trait.
Litany of Condemnation	Willpower 40, Scholastic Lore (Imperial Creed) +10	Willpower	Social	Character may inspire others to resist Fear from Daemons and their ilk.
Little 'Un	Fellowship 30, Non-Ogryn	Fellowship	General	Character is easily liked and trusted by Ogryns.
Loyal Demeanour	Ogryn	Fellowship	Leadership	Others take character more seriously.
Overlooked	Perception 35, Unremarkable	Perception	Defence	Enemies attack other characters first.
Potentia Coil Induction	Implanted Potentia <i>or</i> Mechanicus Implants, Toughness 35	Toughness	Tech	Draw on external power sources to reduce Fatigue.
Rabbit Punch	Agility 35, Weapon Skill 35	Agility	Finesse	Use AB for unarmed Damage.
Strength in the Creed	Ministorum Priest <i>or</i> 10+ Insanity Points	Willpower	Offence	Invoke the Imperial Creed for inspiration on an attack.
Unusual Companion	Fel 30	General	Social	Gain a non-standard Comrade.
Urge the Penitent	Command +10, Scholastic Lore (Imperial Creed)	Fellowship	Social	Benefit when re-rolling Tests with Fate Points.

TABLE 3-2: TIER 2 TALENTS

Talent	Prerequisites	Aptitude 1	Aptitude 2	Benefit
Accelerated Repairs	Any Essential Repair Skill +20, Tech-Use +10	Intelligence	Tech	Character may conduct repairs more swiftly.
Aspire to Vengeance	WS 40, WP 40	Fellowship	Offence	Character gains powerful benefits to attacks upon the loss of an ally.
Battlefield Tech-Wright	Any Essential Repair Skill +10, Willpower 35	Willpower	Tech	Ignore penalties from distractions on Tech-Use and Repair Tests.
Confessor	Fellowship 35, Ministorum Priest, Willpower 35	Fellowship	Leadership	Other characters may remove additional Insanity Points for XP.
Integrated Weapon Expertise	Ballistic Skill 40, Implanted Potentia <i>or</i> Mechanicus Implants	Ballistic Skill	Defence	Reduce Integrated weapon penalties.
Perfected Maintenance	Common Lore (Adeptus Mechanicus) +20, Initiated Maintenance	Ballistic Skill	Tech	Improves the Craftsmanship of one item temporarily.
Ratling Requisitions	Agility 45, Ratling	Agility	Social	Spend a Fate Point to automatically "requisition" a small item.
Ripper Charge	S 45, Bulging Biceps	Ballistic Skill	Offence	Make Full-Auto attack with Charge Move.
Surefoot Wayfinder	Survival +10	Perception	Fieldcraft	Move through difficult terrain and gain bonuses to tracking
The Bigger They Are	BS 40	Ballistic Skill	Finesse	Modify Hit Location on larger enemies.
Vengeful Protector	WS 45, S 45	Strength	Offence	Deal increased Damage to enemies that have harmed squad mates.
Wild Charge	S 45, Berserk Charge	Strength	Offence	Charge attacks are more difficult to evade, but gain a smaller bonus to hit.

### ACCELERATED REPAIRS

**Tier:** 2

**Prerequisites:** Any Essential Repair Skill +20 (see page 281 of the **ONLY WAR** Core Rulebook), Tech-Use +10

**Aptitudes:** Intelligence, Tech

It is a constant source of great vexation to the Adeptus Mechanicus that the revered machine-spirits of tank and bastion and cannon are often placed in harm's way at a much greater rate than the appropriate rites of repair can be offered. Since the needs of the Imperium's war machines are such that it cannot be any other way, skilled and pragmatic Tech-Priests often set themselves to mastering the rites for use at a more practical pace.

The character may now perform Repair Tests at a swifter rate. When opting to perform a Repair Test as a Rush Job (as described on page 282 of the **ONLY WAR** Core Rulebook), he suffers a -10 penalty instead of the normal -30. When electing to make Careful Repairs (as described on page 282 of the **ONLY WAR** Core Rulebook), he increases the Repair Time by 25% instead of 50% (so that a repair that would normally take 12 hours takes a total of 15 hours, instead of the 18 it would normally take with Careful Repairs).

### ASPIRE TO VENGEANCE

**Tier:** 2

**Prerequisites:** Weapon Skill 40, Willpower 40

**Aptitudes:** Fellowship, Offence

Although death in service to the Imperium is no tragedy in the eyes of the Adeptus Ministorum, it is owed to every soldier martyred for the Imperium that his death shall be avenged. Some among the Imperium's clergy hold this principle in particularly high regard, and their strikes are lent a terrible fervour when they witness a death among their flock.

Whenever a Player Character, Comrade, or allied NPC within 50 metres is slain by an enemy, this character enters a hateful fury. Until the end of the encounter, he increases any Critical Damage that he inflicts because of Righteous Fury by 3.

### BATTLEFIELD TECH-WRIGHT

**Tier:** 2

**Prerequisites:** Any Essential Repair Skill +10 (see page 281 of the **ONLY WAR** Core Rulebook), Willpower 35

**Aptitudes:** Willpower, Tech

Veteran Engineers who have survived long tours of duty with the Imperial Guard learn to perform their vital tasks in any circumstance, whether welding tank treads in pouring rain or carefully activating a recalcitrant cogitator while an artillery bombardment shakes the ground below their feet.

The character no longer suffers any penalties to Tech-Use or Repair Tests due to external distractions and reduces all penalties from poor tools or working conditions by a total of 10 (so a **Hard (-20) Repair Test** to fix a tank mired in a swamp would become **Difficult (-10)** instead).

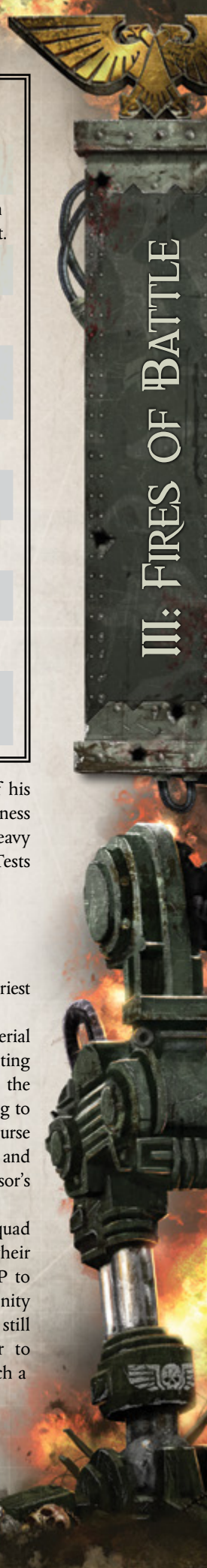

TABLE 3-3: TIER 3 TALENTS

Talent	Prerequisites	Aptitude 1	Aptitude 2	Benefit
Blessing of Flame	WP 45, Scholastic Lore (Imperial Creed) +20	Ballistic Skill	Knowledge	Bless Flame weapons for use against Daemons.
Desperate Strength	Toughness 50, Frenzy	Toughness	Defence	Gain greater Unnatural Strength and Toughness when badly hurt.
Giantkiller	Ballistic Skill 50, The Bigger They Are	Ballistic Skill	Finesse	Deal increased Damage to larger enemies.
Imperial Commander	Fellowship 45, Willpower 40	Fellowship	Leadership	Command mixed units of troops with greater efficiency.
Integrated Weapon Mastery	T 40, WP 40, Implanted Potentia <i>or</i> Mechanicus Implants, Integrated Weapon Expertise	Ballistic Skill	Defence	Suffer Fatigue to gain benefits with Integrated Weapons.
Relic Bearer	Logistics Rating 40+, Scholastic Lore (Imperial Creed) +20	Fellowship	Social	Character is entrusted with a sacred relic.
Suffer Not the Work of Heretics	Hatred (any one), Ministorum Priest <i>or</i> 20+ Insanity Points	Willpower	Offence	Gain benefits to Penetration against targets of your Hatred.
Tear 'em Ter Bits!	Ogryn, Strength 50	Strength	Offence	Spend a Fate Point to dismember a wounded foe.
Thunderous Castigation	Command +20, Scholastic Lore (Imperial Creed) +20	Fellowship	Leadership	Strike fear into enemies with fiery rhetoric.
Underfoot Assault	Agility 40, Weapon Skill 40	Weapon Skill	Finesse	Gain benefits in melee against larger foes.
Vitality Coils	Implanted Potentia <i>or</i> Mechanicus Implants, Potentia Coil Induction, Toughness 45	Toughness	Tech	Draw on external power sources to heal injuries.

## BLESSING OF FLAME

**Tier:** 3

**Prerequisites:** Willpower 45, Scholastic Lore (Imperial Creed) +20

**Aptitudes:** Ballistic Skill, Knowledge

Deep study of the Ecclesiarchy's rites has taught the character how to prepare the promethium fuel of flame weapons to cleanse the taint of Daemons. Through a combination of blessings and the mixture of certain sacred unguents into the fuel, a weapon's flames can become capable of harming even the most potent of Warp-spawned fiends.

As a Full Action, this character may make a **Challenging (+0) Scholastic Lore (Imperial Creed) Test** to bless a single weapon with the Flame Quality. A weapon so blessed (gains automatically sets Daemons aflame when it strikes them and gains the Sanctified Quality for a number of Rounds equal to this character's Willpower Bonus or until the Clip is depleted (if it has one).

## BRUTE OF BURDEN

**Tier:** 1

**Prerequisites:** Strength 45

**Aptitudes:** Strength, General

Moving equipment is one of a soldier's most important jobs on the battlefield, but some soldiers are obviously more adept at such labour than others. Some regiments have even been known to train their Ogryn auxiliaries specifically for this purpose to ease logistical burdens, so that whole encampments can be moved on the backs of loyal soldiers.

This character adds an amount equal to the value of his Size Trait to the total of his Strength Bonus and Toughness Bonus for the purposes of lifting, carrying, or pushing heavy loads. In addition, he gains a +20 bonus on Toughness Tests to avoid gaining Fatigue from a forced march.

## CONFESSOR

**Tier:** 2

**Prerequisites:** Fellowship 35, Willpower 35, Ministorum Priest

**Aptitudes:** Fellowship, Leadership

All those seconded from the Ministorum to attend the Imperial Guard as their flock are skilled in rousing the spirits of fighting men towards courage and battle. A rare few also train in the more merciful aspects of the Emperor's protection, learning to assuage the guilt and fear and trauma suffered in the course of endless war. By hearing the confessions of Guardsmen and granting counsel and penance, those trained in the Confessor's arts can ease troubled souls back into their proper focus.

The character may hear the confessions of his squad mates between missions, and grant them a reprieve from their concerns. Whenever a character in the Squad spends XP to remove Insanity Points, he may remove an additional Insanity Point for each 100 XP spent. Characters in the Squad still cannot reduce any Degrees of Madness gained prior to spending XP—such trauma has already become too much a part of them for remedy.

## DESPERATE STRENGTH

**Tier:** 3

**Prerequisites:** Toughness 50, Frenzy

**Aptitudes:** Toughness, Defence

Many warriors are capable of calling upon seemingly unnatural power when death looms over them. The rage of a wounded Ogryn is particularly terrible to behold, and never more so when the fear of death manages to enter one's thick skull. Once driven by such desperation, even the most dull-minded warrior can draw on reserves of terrifying might.

While the character is Heavily Damaged, he gains the Unnatural Strength (1) and Unnatural Toughness (1) Traits (or increases the value of each of these Traits by 1 if he already possess them). While the character is suffering from Critical Damage, he increases the value of each of these Traits by an additional 1. The character still determines his threshold for being Heavily Damaged based on his Toughness Bonus before this Trait is applied.

## EARS TO THE GROUND

**Tier:** 1

**Prerequisites:** Commerce, Perception 30

**Aptitudes:** Perception, Social

Some in the Imperial Guard develop something of a black market over the course of long service, as errors in requisitions pile up and armaments or other items are shipped to the wrong front to be under-supplied or made overabundant. In some poorly-disciplined regiments, a few individuals make careers out of becoming unofficial quartermasters of such materiel, but the trade can be found even where there is greater scrutiny.

The character has learned how to make the appropriate discreet inquiries to get involved in such trades. He gains +20 to Commerce Tests when trading or bartering excess gear as described on page 162 of the **ONLY WAR** Core Rulebook. Furthermore, the character has learned to avoid official attention from the Commissars and other disciplinary bodies, and gains +10 to Deceive Tests to avoid or deflect such notice about these dealings.

## GIANTKILLER

**Tier:** 3

**Prerequisites:** Ballistic Skill 50, The Bigger They Are

**Aptitudes:** Ballistic Skill, Finesse

Ratling marksmen often boast that their smaller size makes them especially suited to taking down larger foes, as they can see details that would be missed by a larger observer. Human snipers claim that the Ratlings train at such tasks as a vindictive way of compensating for their short stature. Whichever claim is true, many a Guardsman owes his life to such expertly placed shots.

When firing at a target with a Size Trait with a value greater than his own, this character adds the difference in the values of their Size Traits to the Damage of the attack.

*Example: Tomard the Ratling fires his long las at an onrushing Ork Nob. As a Ratling, Tomard possesses the Size (3) Trait, while the Ork Nob is a hulking Size (5). Tomard's shot inflicts +2 Damage, as the Ork's Size Trait has a value 2 points higher than his own.*

## IMPERIAL COMMANDER

**Tier:** 3

**Prerequisites:** Fellowship 45, Willpower 40

**Aptitudes:** Fellowship, Leadership

Through long experience and service, some men become adopted as brothers-in-arms by every group they serve with, from abhumans to the Adeptus Terra. These paragons of duty are able to command unquestioning attention and obedience from any soldier in the Imperial war machine. They do not do so out of any greater authority than usual, but by their shared bonds of service.

The character never suffers penalties due to unfamiliarity or outsider status to Interaction Tests with soldiers serving in the Imperial Guard. This includes all auxiliary forces sworn to the Imperial Guard from the Adeptus Mechanicus, Adeptus Ministorum, and elsewhere. When commanding a combined force of multiple different elements (such as Guardsmen and Ogryns, or the Crimson Guard and a Ministorum detachment), the character gains a +20 bonus to any Command Tests to maintain order in the ranks.

## INITIATED MAINTENANCE

**Tier:** 1

**Prerequisites:** Common Lore (Adeptus Mechanicus) +10

**Aptitudes:** Ballistic Skill, Tech

Although the deepest mysteries of technology are reserved for those in the ranks of the Red Priesthood of Mars, it is possible for a soldier dedicated to the Cult Mechanicus to learn a number of secrets appropriate to his station. In the Crimson Guard, it is common for the common troopers to learn advanced maintenance rites beyond those disseminated by the Departamento Munitorum. This character has mastered the secrets of the maintenance rites for all weapons within the arsenal of the Imperial Guard. The machine spirits of lasgun and flamer respond to him, and even the volatile war-spirit of plasma weaponry acknowledges his touch.

Weapons this character wields only Jam on a result of 100, and weapons with the Overheat Quality that he wields only Overheat on a result of 96–100.





## IT NOT SO DARK

**Tier:** 1

**Prerequisites:** Ogryn, Willpower 40

**Aptitudes:** Willpower, General

While no Ogryn ever truly feels comfortable confined in small spaces, some of them learn to suppress their fear and act normally once they have been made to enter such areas. Some extraordinary souls even submit themselves to small confines on their own limited initiative, and the rest simply make the best of the situation when necessary.

The character no longer suffers a penalty to act in confined spaces from the “But It Dark in Dere!” Trait. In addition, the Ogryn may make a **Hard (-20) Willpower Test** to enter a confined space of his own accord if his duties demand it. If he fails, he must still be ordered into such a space as normal.

## LITANY OF CONDEMNATION

**Tier:** 1

**Prerequisites:** Willpower 40, Scholastic Lore (Imperial Creed) +10

**Aptitudes:** Willpower, Social

When confronted by the otherworldly horrors of Daemons and the foul forms of mutants, even the redoubtable soldiers of the Imperial Guard often find their resolve wavering. For this reason, the Adeptus Ministorum trains its preachers to stoke the fires of hate against these unnatural foes, that they might bolster the courage of soldiers confronting them.

This character scores an additional three Degrees of Success whenever he succeeds on a Command Test to use the Terrify Special Use of the Command Skill to counteract the presence of Daemons, mutants, and the unnatural effects of the Warp.

## LITTLE ‘UN

**Tier:** 1

**Prerequisites:** Fellowship 30, Non-Ogryn

**Aptitudes:** Fellowship, General

Beyond trained handlers and assigned charges, it is rare for any human to get on well with Ogryns, however well-meaning the large abhumans can be. Occasionally particularly large soldiers get special attention from them as easier to pick out of the “little ‘uns.” However, it is also possible for any man to learn the right mix of words and demeanour that allow them to command Ogryns with ease.

This character scores an additional two Degrees of Success whenever he succeeds on a Fellowship-based Test directed at an Ogryn. Furthermore, he is able to inspire a fierce loyalty in the large abhumans, who may re-rolled any failed Tests to resist coercion or other inducement to betray or turn against him.

## INTEGRATED WEAPON EXPERTISE

**Tier:** 2

**Prerequisites:** Ballistic Skill 40, Implanted Potentia or Mechanicus Implants

**Aptitudes:** Ballistic Skill, Defence

The character has learned to correct for the failings of his mortal flesh through his bond to the unflinching steel and circuitry of his weapons, pushing these systems beyond human limits to make his shots strike home.

Whenever this character succeeds on a Ballistic Skill Test with an Integrated Weapon he may choose to gain 1 Level of Fatigue. If he does so, he scores an additional two Degrees of Success on that Test.

## INTEGRATED WEAPON MASTERY

**Tier:** 3

**Prerequisites:** Toughness 40, Willpower 40, Implanted Potentia or Mechanicus Implants, Integrated Weapon Expertise

**Aptitudes:** Ballistic Skill, Defence

The character has learned to regulate the energy flows from his potentia coil with unusual discipline, and can draw upon his natural bioelectric reserves to supplement the power they grant to his weaponry.

As a Free Action, the character may choose to gain a number of Levels of Fatigue up his Toughness Bonus. For each level of Fatigue the character gains in this way, he increases the Damage and Penetration of each of his integrate weapons by 1 for a number of Rounds equal to his Willpower Bonus.



## LOYAL Demeanour

Tier: 1

**Prerequisites:** Ogryn

**Aptitudes:** Fellowship, Leadership

The officers and even common soldiery of the Imperial Guard rarely take the words of Ogryns seriously. Typically this matters very little, with not even Bone 'eads having much to contribute to discussions of any sort. The rare Ogryns entrusted with matters of importance either learn to impress listeners with an obvious display of stern devotion to duty.

This character never suffers penalties to Fellowship Tests for not being taken seriously or due to being an Ogryn, and may re-roll one failed Charm Test per game session.

## OVERLOOKED

Tier: 1

**Prerequisites:** Perception 35, Unremarkable

**Aptitudes:** Perception, Defence

While the small stature of a Ratling limits the great deeds of might and valour that can be accomplished by his strength of arms, it goes a long way to ensuring his survival on a chaotic battlefield. Many a Ratling veteran has mastered the art of looking harmless, or at least less harmful than his brothers-in-arms.

Any enemy who this character has not already attacked this encounter must pass a **Routine (+20) Intelligence Test** to attack this character so long as there is a friendly character with a Size Trait with a higher value within 5 metres. If a foe fails this Test, he ignores this character in favour of a larger nearby target.

## PERFECTED MAINTENANCE

Tier: 2

**Prerequisites:** Common Lore (Adeptus Mechanicus) +20, Initiated Maintenance

**Aptitudes:** Ballistic Skill, Tech

The character can now maintain the weapons from his Standard Kit to a vastly higher standard of operation if given sufficient time to enact the proper rites, speak the supplications of the machine spirits, and anoint his wargear and equipment for battle.

Once per game session, this character may make a **Challenging (+0) Tech-Use Test** as a Full Action to substantially improve the functioning of one piece of his personal equipment. If he succeeds, the chosen item counts as being one level of Craftsmanship higher the end of the game session, plus one additional level per Degree of Success he scores beyond the first (to a maximum of Best Craftsmanship).

## POTENTIA COIL INDUCTION

Tier: 1

**Prerequisites:** Implanted Potentia *or* Mechanicus Implants, Toughness 35

**Aptitudes:** Toughness, Tech

The Crimson Guard are said to be as relentless as machines on the march, capable of making journeys on foot with full kit that other regiments could not manage unburdened. While much of this claim can be attributed to their fearsome reputation, the veteran warriors of the Adeptus Mechanicus can achieve feats far beyond the endurance of frail human flesh by drawing on external reserves of power.

The character has learned to feed additional power to his potentia coil through electroo inductors and eliminate any weariness or strain he suffers from. When in the presence of a suitable power source, such as a portable generator or the power plant of one of his regiment's fighting vehicles, he may make an **Ordinary (+10) Toughness Test** and recover from a number of levels of Fatigue equal to the Degrees of Success achieved on the Test.



## RABBIT PUNCH

Tier: 1

**Prerequisites:** Agility 35, Weapon Skill 35

**Aptitudes:** Agility, Finesse

Although Ratlings are more commonly reviled for weakness or frailty than renowned for strength, veterans of the Imperial Guard rarely relish the notion of brawling with these small warriors. All too often, they carry the memories (and scars) from altercations with Ratlings they underestimated. Although small, such fighters possess the cunning and speed to become unsurpassed masters of dirty fighting.

This character has learned how to match finesse to brutality and hit any enemy exactly where it hurts the most. When making an Unarmed Attack (see page 251 of the **ONLY WAR** Core Rulebook), this character adds his Agility Bonus to Damage instead of his Strength Bonus.

## RATLING REQUISITIONS

**Tier:** 2

**Prerequisites:** Agility 45, Ratling

**Aptitudes:** Agility, Social

The common reputation of Ratlings as thieves does much to keep the eyes of quartermasters on any Ratling in their vicinity. For some Ratlings, this deters them enough to try their luck elsewhere, or even to behave honestly and accept assigned ration limits. For others, it is taken as a challenge to master the art of purloining small items with a “five-fingered requisition”—something the small, quick folk excel at.

When making Requisitions during after receiving Mission Assignment Gear, the character may spend a Fate Point to automatically acquire any single small item of Rare availability or less that might be reasonably held in the regiments stores. The item must be approximately the size of a laspistol or smaller, although larger items may be acquired with a plan or an Agility Test at the GM’s discretion. The character is subject to severe punishments if his theft is discovered, but the GM should remember that quartermasters are busy men who can rarely find time to take a complete inventory (and so many authority figures may assume the character requisitioned the item normally). If the character wishes to return the item to stores after the mission, it can be assumed the return is just as successful as the acquisition.

## RELIC BEARER

**Tier:** 3

**Prerequisites:** Logistics Rating 40+, Scholastic Lore (Imperial Creed) +20

**Aptitudes:** Fellowship, Social

Every regiment maintains a number of sacred relics central to its history and identity as a fighting unit. Foremost among them is the regimental standard flown at its founding, which holds a unique honour and is borne by the regimental standard bearer. However, the collection is typically vast, and also includes such items as the remains of revered leaders and warriors, fragments of their ancient wargear, or the spent casings of miraculous and decisive shots from the regiment’s weaponry. One of the duties of the chaplains and preachers seconded by the Adeptus Ministorum is to tend to these relics just as they tend to the spirits of soldiers, and the worthiest of them are often permitted to bear a relic from the regiment’s vaults into battle as a symbol of pride and victory.

The character has earned this rare honour, and possesses a relic as part of his Standard Kit—perhaps the finger bone of a blessed Imperial saint, a scrap of the death shroud used to swaddle the remains of a valiant Lord General, or the shattered remains of a glorious hero’s favoured weapon. While he displays this relic, all allies within 30 metres gain a +20 bonus on Tests to resist Fear and Pinning, as well as any Tests to avoid gaining Corruption or Insanity Points.

However, the loss of a relic is a deep and terrible shame. If the character loses the relic or allows it to be destroyed, he immediately loses all remaining Fate Points for the session, and ceases to gain any benefit from this Talent. In order to benefit from this Talent again, the character must recover or restore the relic.

## RIPPER CHARGE

**Tier:** 2

**Prerequisites:** Strength 45, Bulging Biceps

**Aptitudes:** Ballistic Skill, Offence

Ogryns typically take to all aspects of combat with enthusiasm, but their limited grasp of tactics tends to lead them straight towards the enemy with great haste—something most commanding officers find commendable. While some are capable of sufficient restraint (or child-like glee at loud noises) to hold back and fire their ripper guns, most simply charge forwards heedlessly. The cleverest of them—and some other soldiers gifted with a similar lust for battle or a dangerous excess of bravado—realise it is possible to do both at once, and try it at every opportunity.

The character may spend a Full Action to make a Charge Move directly towards a distant enemy. As long as the Charge Move does not bring the character into melee range of the enemy, he may immediately make a Full Auto Burst Action with a ranged weapon as a Free Action. The difficulty of this attack is **Challenging (+0)** instead of **Difficult (-10)** as with a normal Full Auto Burst.

## STRENGTH IN THE CREED

**Tier:** 1

**Prerequisites:** Ministorum Priest *or* 10+ Insanity Points

**Aptitudes:** Willpower, Offence

For the zealous preacher and the dutiful soldier, there is no greater solace than the words of the Imperial Creed. The most devoted amongst the warriors of the Imperium can draw strength from the words as surely as combat stims, and bring the Emperor’s wrath to bear in accord with his word.

Whenever this character spends a Fate Point to gain a +10 bonus on a Test before rolling, he gains an additional +20 bonus (to a total of a +30 bonus) instead.

## SUFFER NOT THE WORK OF HERETICS

**Tier:** 3

**Prerequisites:** Hatred (any one), Ministorum Priest *or* 20+ Insanity Points

**Aptitudes:** Willpower, Offence

Some servants of the God-Emperor are satisfied by a heretic dead at their feet, but for many more, it is not enough until all that he has wrought is torn down. From the profane idols of his blasphemous devotion to his unsanctified machines of war, all that is crafted by the hand of the heretic is as surely doomed as the blasphemer himself. By devoting himself to this ideal, the character has learned to unmake the works of his most hated foes among the enemies of the Imperium.

When attacking an enemy for whom he possesses an appropriate Hatred Talent, or a vehicle, structure or object crafted by such an enemy, he increases the Penetration of all attacks by an amount equal to his Willpower Bonus.

If the character possesses the Inspire Wrath Talent from the **ONLY WAR** Core Rulebook, he passes this benefit along with any Hatred Talents when using it. Characters so affected gain benefits based on the Willpower Bonus of the character who inspired them.

## SUREFOOT WAYFINDER

**Tier:** 2

**Prerequisites:** Survival +10

**Aptitudes:** Perception, Fieldcraft

Ratlings are no more inherently inclined towards the wilderness than normal humans, as they come from a wide variety of worlds with many different levels of habitation and biomes. However, they often display a practiced hand at outdoorsmanship on par with the best trackers. Ratlings who dedicate themselves to making the most of this advantage can slip through small spaces and easily spot details that would escape more distantly placed eyes.

The character ignores penalties to his Movement Rate due to thick terrain, although particularly dangerous environments, such as burning buildings, can still penalise him at the GM's discretion. He may also re-roll one failed Test for the Tracking Special Use of the Survival Skill per Game Session.

## TEAR 'EM TER BITS!

**Tier:** 3

**Prerequisites:** Ogryn, Strength 50

**Aptitudes:** Strength, Offence

A truly enraged Ogryn is a terrible thing to behold, as childlike glee and enthusiasm gives way to something altogether fiercer and more primal. Enemies that provoke an Ogryn into such a state find only the small mercy that they do not have to endure such a terror for long, although their surviving comrades are likely to remember the grisly scene for the rest of their lives.

Once per encounter, when this character inflicts Critical Damage on an enemy by dealing Damage in excess of the enemy's Wounds, he may spend a Fate Point to instantly slay his foe in an exceptionally gruesome manner. The enemy may be literally pulled apart by the Ogryn's blows, cleaved into bits, or dismembered in some other terrifying display of might. He gains the Fear (2) Trait against all foes who witnessed this savage display until the end of the encounter.

## THE BIGGER THEY ARE

**Tier:** 2

**Prerequisites:** Ballistic Skill 40

**Aptitudes:** Ballistic Skill, Finesse

Many Ratling marksmen specialise in taking down larger foes, from xenos beasts to the war machines of traitors. With a practised eye, they can size up a target for any weak points or vulnerabilities and land an expertly placed shot just where they need it.

When making a single-shot ranged attack against a target with a Size Trait with a value greater than his own, the character may modify his Hit Location result by an amount up to twice the value of the target's Size Trait.

*Example: Tomard the Ratling lands a hit on the Side Armour of a Leman Russ tank controlled by the Severan Dominate with a roll of 13. This would normally result in a Hit Location result of 31, indicating that he had struck the Hull. However, the Leman Russ is a massive Size (7), allowing him to modify his Hit Location result by up to 14 in either direction—enough to strike the Leman Russ's Motive Systems instead!*

## THUNDEROUS CASTIGATION

**Tier:** 3

**Prerequisites:** Command +20, Scholastic Lore (Imperial Creed) +20

**Aptitudes:** Fellowship, Leadership

The most zealous warrior-priests of the Adeptus Ministorum never enter a fight silently, but let their scorn and hate for their enemies resound forth in fiery oration. Such is their fervour and their fury that foes have been defeated by condemnation alone, as they flee rather than face the wrath of the God-Emperor.

The character may choose to orate against his enemies as a Free Action immediately after rolling for Initiative by making a **Hard (-20) Command Test**. If he succeeds, enemies treat the character as if he possess the Fear (1) Trait for the remainder of the combat. The value of the Fear Trait granted to the character is increased by 1 for every three degrees of success scored on the Command Test beyond the first, to a maximum of Fear (3).

## UNDERFOOT ASSAULT

**Tier:** 3

**Prerequisites:** Agility 40, Weapon Skill 40

**Aptitudes:** Weapon Skill, Finesse

Most Ratlings and other small fighters in the Imperial Guard prefer to avoid melee combat, mastering the long las or similar weapons over the combat knife and other tools of close quarters fighting. Exceptions do exist, and the best of these daring warriors can dart about beneath a larger foe to strike with unavoidable precision.

When making a melee attack against a foe with a Size Trait with a value greater than his own, this character imposes a penalty to any Parry or Dodge Tests made to avoid his melee attacks equal to ten times the difference in the value of their Size Traits.

## UNUSUAL COMPANION

**Tier:** 1

**Prerequisites:** Fellowship 30

**Aptitudes:** General, Social

Most Guardsmen fight alongside other humans for their entire lives, serving without ever working directly with abhumans and other auxiliaries on the battlefield. Sometimes, however, soldiers will end up with an unexpected squad member from a very different background.

Whenever this character receives a Comrade, he can choose for that Comrade to be a standard human Comrade, or to be an Ogryn Comrade (see page 119), Ratling Comrade (see page 120), or Servitor Comrade (see page 121). Other requirements for acquiring Servitor Comrades still apply as normal.

## URGE THE PENITENT

**Tier:** 1

**Prerequisites:** Command +10, Scholastic Lore (Imperial Creed)

**Aptitudes:** Fellowship, Social

Failure in battle is a sin against the God-Emperor, with victory as the only absolution possible. His most devoted servants take any sign of weakness in their flesh or spirit as an inducement to redouble their efforts, and force open the jaws of the defeat that victory might be snatched from within.

The character gains a +10 bonus whenever he re-rolls a Test with a Fate Point after failing his initial attempt. He may spend a Reaction to pass this benefit to any ally spending Fate Points to re-roll a Test, as long as the ally is within line of sight and communication range.

## VENGEFUL PROTECTOR

**Tier:** 2

**Prerequisites:** Weapon Skill 45, Strength 45

**Aptitudes:** Strength, Offence

Ogryns often form strong bonds of devotion and loyalty to their squad mates, sometimes treating them more as family than brothers-in-arms. When these beloved comrades are harmed, they instantly turn an equally strong but opposite focus to the transgressor—a vengeful rage at all those who would harm their adopted kin. Other soldiers often form similar bonds, though the wrath of an Ogryn is especially terrible to behold.

Whenever an ally within 10 metres suffers Critical Damage because of an enemy, this character increases the Damage he inflicts with melee attacks by +X until the end of the encounter, where X is equal to the value of his Size Trait.

## VITALITY COILS

**Tier:** 3

**Prerequisites:** Implanted Potentia *or* Mechanicus Implants, Potentia Coil Induction, Toughness 45

**Aptitudes:** Toughness, Tech

The potentia coil implanted in the initiates of the Cult Mechanicus is thoroughly integrated with both the biological and mechanical components of their frame. This most sacred implant assists in the regulation of everything from the devotee's bioelectric reserves to his heart rate, becoming the lynchpin of his vital functions. In dire circumstances, a hardy servant of the Machine God can draw greater power into his potentia coil to supplement these functions and accelerate his body's healing.

The character has learned to feed additional power to his potentia coil through electroo inductors, and can supercharge it to maximum capacity to restore lost Wounds. Once per game session when in the presence of a suitable power source, such as a portable generator or the power plant of one of his regiment's fighting vehicles, he may make a **Challenging (+0) Toughness Test** as a Full Action. If he succeeds, he removes 1d5 Wounds, plus 1 Wound per additional Degree of Success he scores on the Test. He cannot remove Critical Damage this way. However, the restoration process is potentially volatile, and any irregularities in the power feed can have deadly consequences. If he fails the Test, he suffers 1 Damage ignoring armour and Toughness Bonus, plus 1 additional Damage for every three Degrees of Failure he scores on the Test.

## WILD CHARGE

**Tier:** 2

**Prerequisites:** Strength 45, Berserk Charge

**Aptitudes:** Strength, Offence

The great bulk of an Ogryn makes for intimidating charges upon enemy battle lines, as blazing ripper guns and huge combat blades tear into the foe. These assaults are rarely anything approaching disciplined, but the frenzy of a massive abhuman soldier bearing down on his target often exceeds the value of a more coordinated assault. While Ogryns are not the only ones who can attack with such ferocity, few normal humans can match the brute might that their size grants them.

Whenever this character makes a Charge Action against a target with a Size Trait with a value smaller than his own, he may make a **Challenging (+0) Opposed Strength Test** against the target as a Free Action. If he wins the Opposed Test, his target suffers a -30 penalty to Tests to Dodge or Parry his attack.



## NEW ORDERS

In order to survive the harsh battlefields of the 41st millennium, soldiers must learn what they can rely on. From the dullest Ogryn to the most cunning Ratling, every soldier has only two certainties to hold onto (beyond the high probability of imminent death!). A Guardsman can rely on the training he received, the comrades he serves with, and very little else. Yet with these two simple tools and a bit of ingenuity, any soldier can develop a plan of action that might yet see him safely off the battlefield.

The Orders presented here are the sort that come from these two key resources, and as such, they are dependent on having the right training and background. In some cases, they also require specific Comrade types. Each category of Orders describes which characters are eligible to purchase these Orders. The Orders in this section are not considered Generic Orders (see pages 270–271 of the **ONLY WAR** Core Rulebook).

In the same way as Skills and Talents, these Orders have associated Prerequisites, which Player Characters must meet before they can purchase them, and associated Aptitudes, which determine their cost for individual Player Characters based on which Aptitudes they possess. These costs are listed on **Table 3–4: Order Costs**.

TABLE 3–4: ORDER COSTS

Matching Aptitudes	Cost
Two	300
One	450
Zero	900

## SWEEPING ORDERS

Sweeping Orders are usually the purview of the Sergeant Speciality, but other Player Characters can sometimes get access to Sweeping Orders by various means, such as the Orders included in this section or various Advanced Specialities.

Sweeping Orders affect all Comrades (both the character's and those of other Player Characters) within communication range of the character giving the Order. Player Characters can only issue a single Sweeping Order per Turn.

## ATTACK ORDERS

Under most circumstances, Comrades do not have their attacks against the enemy directly represented with independent Attacks or Tests. Their limited capabilities mean that they rarely accomplish much more than assisting the more competent Player Characters, and the Orders system reflects this. However, in some rare cases, a Comrade possesses a unique capability that the controlling Player Character might not have on his own. This is most common with Servitor Comrades, who can have integrated heavy weapons systems capable of tremendous firepower.

These capabilities are unleashed by giving the Comrade an Attack Order. Issuing an Attack Order uses only a Free Action from the Player Character as normal, but unlike other Free Actions, an Attack order has the Attack subtype, and thus prevents the Player Character from making an attack of his own. Even the most heavily armed Comrades lack the experience and precision of Player Characters, and require additional guidance or a lack of distraction in order to place their shots and strikes effectively.

Attack Orders are made using the Comrade's Weapon Skill or Ballistic Skill Characteristic, although this may vary from the value in the relevant default profile, as noted in the specific Comrade variant or Servitor Pattern. Any modifiers that would apply to a normal attack also apply to an Attack Order, such as modifiers for distance or outnumbering a target in melee.

## ENGINESEER ORDERS

These Orders reflect the training common to the disciples of the Machine God. Some are exclusive to members of the Adeptus Mechanicus and any of their initiated vassals, as listed in their Prerequisites. For this purpose, a Prerequisite of "Adeptus Mechanicus" includes Tech-Priest Engineers and all Advanced Specialities subsequent to it, as well as members of regiments sworn to the service of the Adeptus Mechanicus. This most commonly means the Crimson Guard of the Lathe Worlds, but other regiments can qualify at the GM's discretion.

## ATTEND THE MACHINE SPIRIT

**Type:** Order (Half Action)

**Prerequisites:** Common Lore (Adeptus Mechanicus), Tech-Use +10

**Aptitudes:** Intelligence, Tech

**Effect:** The character has passed some of his extensive technological knowledge on to his Comrade, enabling the Comrade to assist with complex activation rites and the careful calibration of complex technologies. When assisted by his Comrade, the character can more easily accomplish anything from reinitialising the generatorium plant of a Lemman Russ to performing pinpoint scans with an auspex.

A Character can use this Order when he attempts to activate or operate a piece of technology that requires a Tech-Use Test. The character's Comrade assists him with the Test, granting the character a +10 bonus. The character's Comrade must be in Cohesion to enact this Order. This Order is usable with a Servitor Comrade.



TABLE 3-5: ENGINEER ORDERS

Order	Type	Prerequisites	Aptitude 1	Aptitude 2	Benefit
Attend the Machine Spirit	Order (Half Action)	Common Lore (Adeptus Mechanicus), Tech-Use +10	Intelligence	Tech	Comrade assists in using advanced tech.
Honour the Weapon	Order (Half Action)	Common Lore (Adeptus Mechanicus), Common Lore (Tech)	Ballistic Skill	Tech	Comrade clears a Jammed weapon.
Preserve the Burning Chariot	Order (Full Action)	Adeptus Mechanicus, Any Essential Repair Skill +10	Intelligence	Tech	Comrade attempts to put out a fire within a vehicle.
Unwind the Machine-Cant Secrets	Order (Full Action)	Adeptus Mechanicus, Common Lore (Adeptus Mechanicus) +20, Forbidden Lore (Archeotech)	Intelligence	Tech	Comrade assists in understanding ancient or unknown machinery.

### HONOUR THE WEAPON

**Type:** Order (Half Action)

**Prerequisites:** Common Lore (Adeptus Mechanicus), Common Lore (Tech)

**Aptitudes:** Ballistic Skill, Tech

**Effect:** The character has ensured his comrade is well-versed in the maintenance and care of all weapons in the arsenal of the Imperial Guard, so that he may ensure that their machine spirits are kept in proper order. When excessive use or hazardous circumstances rile the spirits of his squad's weapons, he may send his comrade to undo the harm with the briefest of signals.

The character may issue this Order whenever a character in his squad (including himself) is suffering from a weapon Jam. His Comrade immediately repairs the Jam without a Test, as long as the character with the Jammed weapon is within five meters. The character's Comrade must be within communication range to enact this Order. This Order is usable with a Servitor Comrade.



### PRESERVE THE BURNING CHARIOT

**Type:** Order (Full Action)

**Prerequisites:** Adeptus Mechanicus, Any Essential Repair Skill +10 (see page 281 of the **ONLY WAR** Core Rulebook)

**Aptitudes:** Intelligence, Tech

**Effect:** The loss of valuable technology to war is an unfortunate and inevitable reality for its devoted caretakers, but they nonetheless drill ceaselessly in all possible means of preserving it against harm for as long as possible. Through careful study of the volatile war spirits of armoured vehicles, the character is able to direct his comrade to put out fires aboard any vehicle aboard which they travel.

This Order can be used to direct a Comrade to assist in fire-fighting efforts, or to direct him to put out a fire while the character performs other Actions. If the Comrade is assisting his controlling Player Character in putting out a fire, he grants the relevant Test a +20 bonus. A Comrade that is being directed to put out a fire on his own does so if the controlling Player Character passes a **Hard (-20) Command Test**. Note that the difficulty of this Test is due to being on board a burning vehicle, rather than in addition to that penalty. This Order is usable with a Servitor Comrade.

### UNWIND THE MACHINE-CANT SECRETS

**Type:** Order (Full Action)

**Prerequisites:** Adeptus Mechanicus, Common Lore (Adeptus Mechanicus) +20, Forbidden Lore (Archeotech)

**Aptitudes:** Intelligence, Tech

**Effect:** In the 41st Millennium, technology is ill-understood, and even familiar devices often contain functions unknown to all but the initiates of the Omnissiah.

This Order can be used whenever the character interacts with a new piece of archeotech, xenotech, or other unfamiliar machinery. So long as the Comrade is within communication range, the character can command him to assist in unwinding the complex metal riddle that conceals the device's purpose; he may make a **Routine (+20) Forbidden Lore (Archeotech) Test** to discover the machine's function. If he succeeds on this Test, he not only determines the device's purpose, but also gains a +20 bonus on any Tech-Uses Tests he makes involving the device until the end of the encounter. This Order is usable with a Servitor Comrade.

## PRIEST ORDERS

These Orders represent the fiery oratory of a trained preacher from the Adeptus Ministorum. Some of these are exclusive to members of the Adeptus Ministorum, as listed in their Prerequisites; others can be taken by any character with sufficient zeal. Full details for which characters qualify for a Prerequisite of “Ministorum Priest” can be found on page 43.

### CLEANSE WITH FIRE!

**Type:** Order (Half Action)

**Prerequisites:** Scholastic Lore (Imperial Creed), Weapon Training (Flame)

**Aptitudes:** Ballistic Skill, Offence

**Effect:** The character has ensured his Comrade is equipped with the necessary tools to create and maintain his battle-pyres. Thanks to these efforts, the comrade carries a hand flamer, burning brazier, censer full of igniferous fluids, or similar tool of cleansing and purification. When commanded, the Comrade joins his effort to the fiery assaults of the character to bring burning light into the darkness of enemy forces, to ensure its continued flame.

The character can issue this Order whenever any enemy within 10 meters of the character’s Comrade is on fire. Until this character’s next Turn, the chosen foe suffers a –20 penalty on any Tests to extinguish its flames, and suffers an additional 1d5 Damage from the effects of the Flame Quality whenever it affects him. The character’s Comrade must be in Cohesion to enact this Order.

### COWER NOT BEFORE THE ENEMY!

**Type:** Sweeping Order (Free Action)

**Prerequisites:** Ministorum Priest *or* 10+ Insanity Points

**Aptitudes:** Fellowship, Leadership

**Effect:** The Imperium has no room for shirkers or the dereliction of duty, and it is one of the duties of a battle preacher to see that every soldier gives his all in the God-Emperor’s wars. Hesitation and flight have no place among the actions of a right-thinking soldier, and the fiery rhetoric of the Adeptus Ministorum serves to remind even the most petrified warrior of his duty to the Imperial Guard.

As part of this Order, the character must make a **Challenging (+0) Charm or Command Test**. If he succeeds, all Comrades in communication range immediately overcome any ongoing Fear or Pinning effects they are suffering. They can act normally in subsequent Turns.

### DO NOT WAIT FOR DEATH!

**Type:** Sweeping Order (Free Action)

**Prerequisites:** Command +10, Ministorum Priest

**Aptitudes:** Fellowship, Leadership

**Effect:** There is no mortal figure held in higher esteem across the Imperium than the warrior-martyr, who deals death as easily as he accepts it. The Adeptus Ministorum trains its preachers to seek to evoke this ideal among even the most hesitant. Those who are most skilled in rhetoric can inspire feats of near-suicidal bravery from those around them, encouraging them to lay aside all doubt in the prosecution of their cause.

As part of this Order, the character must make a **Hard (–20) Charm or Command Test**. If he succeeds, all Comrades in communication range leap to the fore of the battle, intercepting blows meant for their brethren without regard for their own lives. Until the end of this character’s next Turn, as long as a character’s Comrade is in cohesion with him, the Comrade is struck instead of the character with any attack that would have hit the character. However, if the Attack Test result was a double, the Attack hits the character and is resolved normally.

### LET THE CREED RESOUND!

**Type:** Passive

**Prerequisites:** Command +10, Ministorum Priest

**Aptitudes:** Fellowship, Leadership

**Effect:** Even the best orator must be heard in order to have an effect—a requirement often difficult to meet on a chaotic battlefield. To overcome this barrier, the character has trained his Comrade to relay his words so that they may be more easily passed through the ranks of the Imperial Guard.

As long as this character’s Comrade is in Cohesion with him, the character counts as being equipped with a Laud Hailer, and can affect up to twice the normal number of subjects with his Interaction Skill Tests. This effect stacks with Talents such as Master Orator.

TABLE 3-6: PRIEST ORDERS

Order	Type	Prerequisites	Aptitude 1	Aptitude 2	Benefit
Cleanse with Fire!	Order (Half Action)	Scholastic Lore (Imperial Creed), Weapon Training (Flame)	Ballistic Skill	Offence	Assists the Priest’s fiery attacks.
Cower Not Before the Enemy!	Sweeping Order (Free Action)	Ministorum Priest <i>or</i> Insanity 10+	Fellowship	Leadership	Comrades recover from Fear and Pinning.
Do Not Wait for Death!	Sweeping Order (Free Action)	Command +10, Ministorum Priest	Fellowship	Leadership	Comrades take hits for the Player Characters.
Let the Creed Resound!	Passive	Command +10, Ministorum Priest	Fellowship	Leadership	The Priest’s words are relayed across the battlefield.

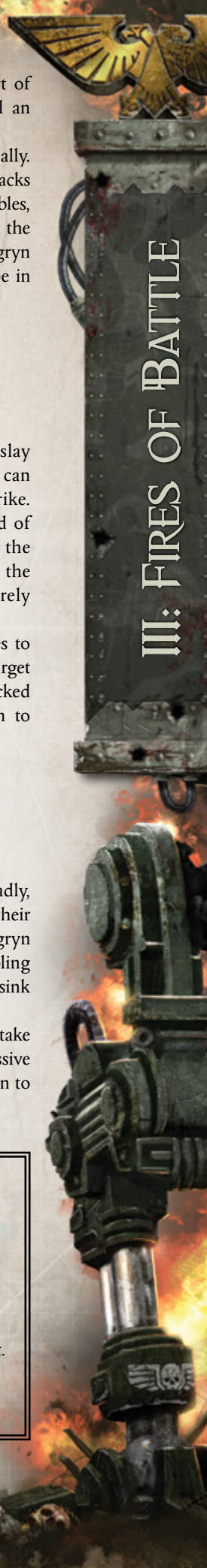

## OGRYN ORDERS

These Orders are derived from the Departamento Munitorum-approved training regimens for Ogryn soldiers of the Imperial Guard. Some of these Orders require the incredible muscle mass and strength of an Ogryn to execute, while others require the support of an Ogryn Comrade, as listed in the Prerequisites. Orders cannot be issued to any Comrade who does not match the type listed in its Prerequisites. Rules for Ogryn Comrades are found on page 119.

### CUT LOOSE!

**Type:** Order (Half Action)

**Prerequisites:** Strength 35, Ogryn Comrade

**Aptitudes:** Ballistic Skill, Offence

**Effect:** Ogryns are notorious among the quartermasters of the Imperial Guard for their prodigious expenditure of ammunition. They rarely, if ever, seem to grasp such concepts of “burst fire” or “aiming,” and sometimes unload full clips into empty air when startled. The most disciplined among their number (for what such a label is worth), and others who work with these massive warriors, can occasionally manage to convince their Comrades to keep the barrels of their ripper guns pointing directly towards the enemy. Though they cannot curb their Comrades’ tendency to over-expend ammunition, this habit can still be made to serve the Imperium, as the wild hail of bullets makes it difficult to evade any more carefully placed fire.

As part of this order, the character’s Comrade wildly unloads as many shots as possible; until the end of the Turn, enemies must re-roll successful Dodge Tests made to avoid attacks by the character. The character’s Comrade must be within Cohesion for him to enact this Order.

### GET BEHIND ME!

**Type:** Order (Half Action)

**Prerequisites:** Toughness 50, Ogryn, non-Ogryn Comrade

**Aptitudes:** Toughness, Defence

**Effect:** Although Ogryns are famously protective of their brothers-in-arms, they are not similarly renowned for taking initiative in their defence of these wards. It usually falls to an Ogryn’s squad mates to determine how his strength and bulk can best shield them in any given situation. However, there are exceptions—Ogryns with the ability to think on

their feet better than most, who have mastered the art of sheltering their smaller and weaker Comrades behind an imposing wall of muscle.

The Ogryn’s Comrade moves behind his massive ally. While sheltered in this way, the Comrade is not hit by attacks (and if an attack would hit him, such as on a result of doubles, it hits the Ogryn instead) and immediately recovers from the effects of Fear and Pinning. This effect lasts until the Ogryn or his Comrade moves. The character’s Comrade must be in Cohesion to enact this Order.

### TAKE ‘EM DOWN!

**Type:** Order (Half Action)

**Prerequisites:** Strength 45, Ogryn

**Aptitudes:** Strength, Offence

**Effect:** The great strength of an Ogryn’s blows can slay almost any foe, but sometimes particularly nimble foes can still prove difficult to kill as they evade strike after strike. An Ogryn frustrated in this way can call upon the aid of his Comrade to help pin down a mobile foe or bowl the enemy over. Once put on the ground and slammed by the full weight of an Ogryn moments later, the enemy rarely gets back up.

As part of this Order, the character’s Comrade moves to engage one foe within his Charge Move distance. The target must make a **Challenging (+0) Dodge Test** or be knocked Prone. This character’s Comrade must be in Cohesion to enact this Order.

### THUMP ‘EM!

**Type:** Order (Half Action)

**Prerequisites:** Ogryn, Ogryn Comrade, Frenzy

**Aptitudes:** Weapon Skill, Offence

**Effect:** If the power of one Ogryn striking a target is deadly, then surely any two Ogryns that manage to coordinate their blows are a force to be reckoned with. Although no Ogryn tolerates long hours of combat drills with anything resembling good grace, sometimes the basic concepts nevertheless sink into their thick skulls with startling effect.

The next melee attack Action the character undertake inflicts an additional +4 Damage and gains the Concussive (0) Quality. The character’s Comrade must be in Cohesion to enact this Order.

TABLE 3-7: OGRYN ORDERS

Order	Type	Prerequisites	Aptitude 1	Aptitude 2	Benefit
Cut Loose!	Order (Half Action)	S 35, Ogryn Comrade	Ballistic Skill	Offence	Comrade sprays target with wild gunfire.
Get Behind Me!	Order (Half Action)	T 50, Ogryn, non- Ogryn Comrade	Toughness	Defence	Player Character defends his Comrade.
Take ‘em Down!	Order (Half Action)	S 45, Ogryn,	Strength	Offence	Comrade attempts to knock down a target.
Thump ‘em!	Order (Half Action)	Ogryn, Ogryn Comrade, Frenzy	Weapon Skill	Offence	Comrade assists Player Character’s attack.

## RATLING ORDERS

These Orders are derived from the Departamento Munitorum-approved training regimens for Ratling soldiers of the Imperial Guard. Some of these require the quick reflexes and sharp eyes of a Ratling to execute, while others require the aid of a Ratling Comrade, as listed in their Prerequisites.

### DISTANCE, ELEVATION, WIND SPEED?

**Type:** Order (Full Action)

**Prerequisites:** Perception 35, Ratling Comrade

**Aptitudes:** Ballistic Skill, Fieldcraft

**Effect:** At the utmost extremes of a weapon's effective firing distance, even the slightest variable in environmental conditions can throw off the accuracy of a shot. Hitting a target at these ranges is as much logic and mathematics as aim, but a well-trained Comrade can help the character quickly determine any adjustments necessary to place his shot.

On any Turn in which the character's Comrade has enacted this Order, the character's ranged weapons treat targets out to three times their weapon's Range as being at Long Range, and treat targets beyond four times their weapon's Range as being at Extreme Range. The character's Comrade must be in Cohesion to enact this Order.

### KEEP THEM OFF BALANCE!

**Type:** Order (Half Action)

**Prerequisites:** Agility 40, Ratling Comrade

**Aptitudes:** Agility, Finesse

**Effect:** The best Ratling fighters are masters of misdirection and improvisation, and they often pass these skills on to their Comrades. Working as a well-honed team, the character and his Comrade create openings for each other's attacks, and then ruthlessly exploit them.

This Order can only be issued after the character has inflicted Damage an enemy with an attack. When the character's Comrade enacts this Order, the enemy Damaged by the character's attack must make a **Challenging (+0) Toughness Test**; if he fails, he is Stunned for one Round. The character's Comrade must be in Cohesion to enact this Order.

### HOSTILES DETECTED!

**Type:** Sweeping Order (Special)

**Prerequisites:** Perception 40, Ratling

**Aptitudes:** Perception, Fieldcraft

**Effect:** The keen eyes of a Ratling have more uses than simply bringing down distant targets. The character may issue this Order when one or more of the other Player Characters have been Surprised. All Comrades affected by this Order immediately spend a Half Action to benefit from cover as if they had been issued the Take Cover! Generic Order, even if their controlling Player Character was Surprised and cannot act.

### THEY'LL NEVER KNOW WHAT HIT THEM!

**Type:** Order (Half or Full Action)

**Prerequisites:** Ratling, Ratling Comrade, Stealth +10

**Aptitudes:** Agility, Fieldcraft

**Effect:** The character has trained his Comrade to cover his tracks, set up blinds, and provide diversions for any searching eyes from the enemy camp. When working together, the two soldiers can pass unseen through nearly any terrain to arrive at the perfect sniper's perch, then rain shot after shot onto their vulnerable targets without being spotted.

As part of this Action, the character's Comrade must expend a Half Action, or a Full Action if the character has made an attack since the beginning of his last Turn. All attempts to spot the character or his Comrade suffer a -20 penalty during any Round in which the character's Comrade has enacted this Order. This Order can be issued outside of combat, in which case its effects can be assumed to apply until the Comrade ceases to work at providing concealment. The character's Comrade must be in Cohesion to enact this Order.



TABLE 3-8: RATLING ORDERS

Order	Type	Prerequisites	Aptitude 1	Aptitude 2	Benefit
Distance, Elevation, Wind Speed?	Order (Full Action)	Per 35, Ratling Comrade	Ballistic Skill	Fieldcraft	Comrade helps compensate for long-distance shots.
Keep Them Off Balance!	Order (Half Action)	Ag 40, Ratling Comrade	Agility	Finesse	Comrade attempts to Stun an enemy the Player Character has hit.
Hostiles Detected!	Sweeping Order (Special)	Per 40, Ratling	Perception	Fieldcraft	Comrades are warned of imminent danger.
They'll Never Know What Hit Them!	Order (Half or Full Action)	Ratling, Ratling Comrade, Stealth +10	Agility	Fieldcraft	Comrade assists in efforts to escape notice.

## SERVITOR DIRECTIVES

These Orders are used to direct Servitor Comrades, such as those possessed by a Tech-Priest Engineer. They cannot be used to direct any other sort of Comrades, as they relate to the use of various subsystems installed in a Servitor. While Servitor Directives are typically purchased with XP like the other Orders in this section, Servitor Directives involving extremely basic and fundamental functions of a purpose-built Servitor are automatically granted to a character with the appropriate Servitor Pattern as a Comrade. These special Servitor Directives are specifically noted in their descriptions, and in the descriptions of the appropriate Servitor Pattern.

### ARMOUR NEGATION PROTOCOLS

**Type:** Order (Half Action)

**Prerequisites:** Lathe-pattern Breacher Servitor Comrade

**Aptitudes:** Weapon Skill, Offence

**Effect:** The necessities of war require the Imperium to not only muster every weapon in its arsenal, but to make weapons of its tools if this proves insufficient. Although breacher servitors are primarily intended for use in mining operations, the powerful drills that make them capable of piercing the roots of mountains are just as capable of punching through the armour of enemy troops should their master wish it.

The character's melee attacks gain +5 Penetration until the end of the Turn. The character's Comrade must be in Cohesion to enact this Order.

### ATTACK PATTERN GLADIUS ULTRA

**Type:** Attack Order (Half Action)

**Prerequisites:** Clipaeus-class Combat Servitor Comrade

**Aptitudes:** None

**Effect:** The primary function of a Clipaeus-class Combat Servitor is to defend its assigned master, a goal which it pursues with ruthless efficiency. Once cleared for action by a brief directive, it unleashes an unrelenting series of brutal jabs and thrusts with its potent electro-gladius, slaying or incapacitating any who presume to threaten its charge.

As part of this Order, the character's Comrade makes a Standard Melee Attack Action against a target within melee range. The character's Comrade must be within communication range to enact this Order. If it is also in Cohesion, it gains a +10 bonus to its Weapon Skill Test.

### ATTACK PATTERN PUGNIS FURIOSO

**Type:** Order (Half Action)

**Prerequisites:** Pugnis-class Combat Servitor Comrade

**Aptitudes:** None

**Effect:** The Pugnis-class Combat Servitor is a common sight on battlefields throughout the galaxy, as are the torn and battered corpses left crushed by its heavy servo-fists. Tech-Priests assigned to combat duties quickly learn how best to coordinate their attacks with the massive strength behind these blows. Those with the resources and training to control several such servitors find some basic adjustments to the servitors' default attack patterns provide even more impressive results



TABLE 3-9: SERVITOR DIRECTIVES

Order	Type	Prerequisites	Aptitude 1	Aptitude 2	Benefit
Armour Negation Protocols	Order (Half Action)	Lathe-pattern Breacher Servitor Comrade	Weapon Skill	Offence	Player Character's attacks gain Penetration.
Attack Pattern Gladius Ultra	Attack Order (Half Action)	Clipaeus-class Combat Servitor Comrade	None	None	Servitor strikes a foe with its electro-gladius.
Attack Pattern Pugnus Furioso	Order (Half Action)	Pugnus-class Combat Servitor Comrade	None	None	Servitor assaults a target with servo-fists.
Barrier Removal Process	Order (Full Action)	Lathe-pattern Breacher Servitor Comrade	None	None	Servitor drills through walls or other barriers.
Bastion Protocols	Order (Half Action)	Servitor Comrade	Intelligence	Defence	Servitor intercepts attacks on its master.
Combat Mnemo-Analysis	Order (Full Action)	Servitor Comrade, Scutiny +10	Perception	Knowledge	Player Character anticipates the target's defences.
Emergency Overrides	Order (Full Action)	Servitor Comrade, Tech-Use +10	Intelligence	Tech	Servitor temporarily ignores some damage.
Flame Sweep Initiation	Attack Order (Half Action)	Incendio-class Gun Servitor Comrade	None	None	Servitor fires integrated flamer
Heavy Firepower Assault	Attack Order (Full Action)	Jovian-pattern Gun Servitor Comrade	None	None	Servitor fires integrated heavy weapon.
Heavy Suppression Barrage	Attack Order (Full Action)	Jovian-pattern Gun Servitor Comrade	Ballistic Skill	Offence	Servitor lays down suppressing fire.
Interdiction Manoeuvre Pattern	Order (Full Action)	Clipaeus-class Combat Servitor Comrade	Weapon Skill	Defence	Servitor intercepts and attacks an approaching enemy.
Precision Firepower Delivery	Attack Order (Full Action)	Jovian-pattern Gun Servitor Comrade	Ballistic Skill	Finesse	Servitor fires precise shot with heavy weapon.

The character gains a +5 bonus to Weapon Skill Tests for Melee Attacks and inflicts an additional +2 Damage with melee attacks until the end of the Turn. If the character controls multiple Pugnus-class Servitor Comrades, he may issue this Order to any number of them, gaining an additional +5 bonus to Weapon Skill Tests and inflicting an additional +1 Damage for each Servitor taking part in the Order beyond the first. The Servitors must be in Cohesion to enact this Order.

### BARRIER REMOVAL PROCESS

**Type:** Order (Full Action)

**Prerequisites:** Lathe-pattern Breacher Servitor Comrade

**Aptitudes:** None

**Effect:** Whether working in a mine or tearing open the walls of a heretic fortress, the diamond-tipped drills of a Lathe-pattern Breacher Servitor have few equals for efficiency or power. Such a servitor can work ceaselessly for days to excavate a vast tunnel, or force entry to a fortified bunker in mere minutes.

As part of this Order, the character's Comrade begins drilling through a wall or other obstructing surface. It continues to spend Full Actions enacting this Order until instructed to do otherwise or until it has completely bored through whatever barrier or surface it was set upon. The drilling process bores through five centimetres of rock each round, or three metres of rock every five minutes.

For softer surfaces such as wood or loose stone, this

rate is doubled, while it may be halved or further reduced by reinforced or hardened surfaces such as fortified stone or metal. By default, Barrier Removal Process opens a breach two metres high and one metre wide, enabling the servitor to proceed through the tunnel it creates. Opening a wider tunnel increases the drilling time proportionately. At the GM's discretion, weak materials might have some chance of collapsing each Round they are drilled this way.

### BASTION PROTOCOLS

**Type:** Order (Half Action)

**Prerequisites:** Servitor Comrade

**Aptitudes:** Intelligence, Defence

**Effect:** Many Tech-Priests add basic bodyguard protocols to the servitors they control, so that their lives and knowledge can be preserved at a minimal cost in resources.

The character orders his Servitor to protect him; until he gives the Servitor the signal to stand down as a Free Action, whenever an attack would strike him, it strikes the Servitor, and vice-versa. The Servitor must be in Cohesion to enact this Order.

## COMBAT MNEMO-ANALYSIS

**Type:** Order (Full Action)

**Prerequisites:** Scrutiny +10, Servitor Comrade

**Aptitudes:** Perception, Knowledge

**Effect:** The addition of mnemo-analysis capabilities is a favoured choice among the myriad common adjustments and recalibrations possible for servitors among the Tech-Priests who serve with the Imperial Guard. When outfitted with the appropriate optical enhancements and other upgrades, a servitor becomes capable of providing valuable metrics on the combat style and manoeuvres of any enemy on the battlefield. This data is provided to its master in a number of arcane ways, from brief bursts of Techna-Lingua code phrases to vox-transmissions sent to a matching mnemo-implant installed in the Tech-Priest's skull. Once gathered, this information makes it all but impossible for the enemy under analysis to surprise the Tech-Priest or act in a way he cannot counter.

When this Order is enacted, the character designates a single foe within his line of sight as the target. Until the beginning of the character's next Turn, the target suffers a -20 penalty to Dodge and Parry Tests to evade the character's attacks, and the character gains a +20 bonus to Dodge and Parry Tests to avoid the target's attacks. The character's Comrade must be in Cohesion to enact this Order.

## EMERGENCY OVERRIDES

**Type:** Order (Full Action)

**Prerequisites:** Servitor Comrade, Tech-Use +10

**Aptitudes:** Intelligence, Tech

**Effect:** As servitors become damaged working in the hazardous conditions of the battlefield, the efficiency of their masters drop drastically. A damaged servitor is more a hindrance than an aid, which is an intolerable situation to the demands of the Imperial war machine. For this reason, many among the Adeptus Mechanicus integrate emergency compensators and power sources into their servitors to allow them to serve through severe damage. These measures can be more destructive in the long term than the damage they mitigate, but this trade off is often deemed acceptable in the heat of battle.

As part of this Order, the character issuing it must choose one of his Servitor Comrades who is Wounded and make a **Routine (+20) Tech-Use Test**. If he succeeds, the Comrade engages its fail-safes and can act as if it was not Wounded or Dead until the end of the encounter, regardless of any further damage it suffers. At the end of the encounter, the Tech-Priest must make a **Hard (-20) Tech-Use Test** to compensate for this dangerous straining of its systems; if he succeeds, the Servitor becomes Wounded, but if he fails, it collapses into a pile of scrap and blood, dead and unsuitable for further use. The character's Comrade must be in Cohesion to enact this Order.

## FLAME SWEEP INITIATION

**Type:** Attack Order (Half Action)

**Prerequisites:** Incendio-class Gun Servitor Comrade

**Aptitudes:** None

**Effect:** The Imperial Guard typically relies on dedicated weapon specialists trained in the use of flame weapons to flush enemies from their bunkers and trenches, and to put fire to their lesser fortifications. When assisted by Incendio-class Gun Servitors, this task can be accomplished where such specialists are unavailable, or when they must perform other battlefield roles. Gun servitors are an efficient alternative to ordinary troopers, who bring with them the concerns of morale or frailty common to mortal flesh.

As part of this Order, the character's Comrade makes a Standard Ranged Attack Action with its integrated flamer. Enemies in the area of effect can attempt to avoid the attack with a **Challenging (+0) Agility Test**, as normal.

## HEAVY FIREPOWER ASSAULT

**Type:** Attack Order (Full Action)

**Prerequisites:** Jovian-pattern Gun Servitor Comrade

**Aptitudes:** None

**Effect:** The big guns of the Imperial Guard are numberless, from the vaunted Deathstrike Missile Launchers and the mighty Earthshaker batteries of the artillery regiments, all the way down to the man-portable weapons carried by the heavy weapon teams of an infantry squad. However, all of these weapons have their origins in the forges of the Adeptus Mechanicus, and they have their own delivery platforms to use.

As part of this Order, the character's Comrade takes a Standard Ranged Attack Action, Semi-Auto Burst Action, or Full Auto Burst Action with one weapon against a target within range of that weapon. The character's Comrade must be within Cohesion to enact this Order.

## HEAVY SUPPRESSION BARRAGE

**Type:** Attack Order (Full Action)

**Prerequisites:** Jovian-pattern Gun Servitor Comrade

**Aptitudes:** Ballistic Skill, Offence

**Effect:** Gun Servitors can make use of their integrated weapons as easily as a trained gunner. Servitors equipped with the appropriate weaponry can lay down withering hails of suppressive fire unmatched by the common soldiery.

This Order can only be issued to Servitor Comrades outfitted with a weapon capable of semi- or fully automatic fire. As part of this Order, the character designates a kill zone, which is any general area, such as a corridor or tree line, that encompasses a 45 degree arc in the direction the Comrade is facing. Then, as part of the Order, the Comrade unleashes Suppressing Fire as detailed on page 248 of the **ONLY WAR** Core Rulebook.

## INTERDICTION MANOEUVRE PATTERN

**Type:** Order (Full Action)

**Prerequisites:** Clipaeus-class Combat Servitor Comrade

**Aptitudes:** Weapon Skill, Defence

**Effect:** The advanced bodyguard protocols imprinted in the Clipaeus-class of servitors grants them unparalleled ability to respond to approaching threats. When placed on alert status by the commands of their master, they wait for attackers to approach, then explode into motion with a swift and deadly pre-emptive strike.

The character gives his Servitor the directive to defend him. Until the beginning of the character's next Turn, the first time an enemy approaches within 5 metres of the character, his Servitor moves to intercept and makes a **Challenging (+0) Weapon Skill Test**. If it succeeds, it inflicts a single hit on the target with its electro-gladius. If the approaching character was making a Charge Action against the character, his attack now targets the Servitor instead of his original target. The Servitor must be in Cohesion to enact this Order.

## PRECISION FIREPOWER DELIVERY

**Type:** Attack Order (Full Action)

**Prerequisites:** Jovian-pattern Gun Servitor Comrade

**Aptitudes:** Ballistic Skill, Finesse

**Effect:** After extensive service, many Gun Servitors end up modified extensively with enhanced targeting protocols and data uplinks that enable pinpoint accuracy, allowing them to unleash their armament to devastating effect. The enhancements made to facilitate this are often unique to each servitor, as they must be integrated carefully with consideration to its optical implants and any relevant cybernetic systems installed in its master.

This Order may only be issued to Servitor Comrades outfitted with a weapon capable of firing single shots. As part of this Order, the character's Comrade makes a Standard Ranged Attack Action against a target within the range of its integrated heavy weapon, which is used for the attack. The Servitor must be in communication range to enact this Order.

# NEW COMRADES

*"The Departamento Munitorum gave me misshapen abhumans, frothing zealots, and clockwork men, and told me they were soldiers of the Imperial Guard. At first I said they were mad to be speaking such a slander against all true Guardsmen. It was later, after the fighting started, that I was grateful and even proud to have such a fine body of warriors under my command."*

—From the suppressed memoirs of Lord Marshal Absalonius

The ranks of the Imperial Guard are not exclusive to the soldiery that hold its trenches and crew its vehicles. Entire regiments can be raised of irregular troops such as abhumans, which have a minimal presence of fully human troops, typically in the officer complement. These warriors fight and die alongside others of their own kind, trusting them just as fully as a human Guardsman relies on his more numerous brothers-in-arms. Auxiliary forces from the Adeptus Mechanicus are also known for their reliance on aid beyond what is typical of human flesh, and frequently employ Servitors in their practice of warfare. For a disciple of the Machine God, the cold logic of a Servitor is to be trusted even above the bonds of brotherhood that bind common Guardsmen.

Rules for these non-standard Comrades are provided below. Each section contains the details on how such Comrades are acquired, how they differ from the rules presented in the **ONLY WAR** Core Rulebook, and a Table to provide more appropriate Demeanours for Comrades of the relevant type.



## OGRYN COMRADES

Ogryn Comrades are typically only available if the Player Characters selects the Unusual Companion Talent, as detailed on page 108. In such a regiment, all standard Comrades are replaced with Ogryn Comrades, both at character creation and when replacing casualties in the squad. Ogryn Comrades follow all normal rules for Comrades except where listed below.

- Ogryn Comrades are extremely robust, and have an additional Wound State. They can be Healthy, Lightly Wounded, Heavily Wounded, or Dead. Furthermore, they suffer no penalties for being Lightly Wounded, although they suffer the effects of being Heavily Wounded as normal.
- Ogryn Comrades grant their controlling Player Character an additional +10 bonus to Weapon Skill Tests when using the Close Quarters Generic Order.
- Player Characters with Ogryn Comrades must pass an **Ordinary (+10) Command Test** to use the Take Cover! Generic Order. While such Comrades are typically willing to carry out the order, Ogryns are not very good at hiding!
- Ogryn Comrades have the But It Dark In Dere Trait, as detailed on page 91 of the **ONLY WAR** Core Rulebook. Player Characters who have already entered an enclosed location receive a +20 bonus to the Command Test



- to order their Comrades in after them, instead of the normal penalty, as the Comrade is more likely to trust the judgment of his own kind on whether he fits inside.
- If anything ever happens to an Ogryn Comrade that requires information from a profile, refer to the Ogryn Profile on page 373 of the **ONLY WAR** Core Rulebook.
- Ogryn Comrades roll for their Demeanour on **Table 3-10: Ogryn Demeanours**. At the GM's discretion, a player may pick any Demeanour for his Comrade except for "**He's a Clever 'un!**" instead of rolling on the table.

TABLE 3-10: OGRYN Demeanours

1d10

Roll Demeanour

- |    |   |
|----|---|
| 1  | <b>Aggressive:</b> The character has a taste for battle that exceeds even the general rowdiness common to Ogryns. He often picks fights with anyone who looks tough enough to hold his interest, and eagerly waits for the next assault on enemy lines.   |
| 2  | <b>Boisterous:</b> While generally good natured, the character has an appetite for indulging in feats of physical strength that can cause significant damage to equipment or personnel. Nothing pleases him more than showing off how strong he is, and he rarely understands the limits of what he works with until something (or someone) has broken.                                   |
| 3  | <b>Crude:</b> While Ogryns are hardly known for their discipline and self-restraint, this one is a bad example for all around him. He guzzles down any drink rations he can get his hands on, sings loud and poorly-pronounced ditties, and generally makes a great deal of trouble for his minders.  |
| 4  | <b>Devoted:</b> Allegiance to the Imperium of Man has been thoroughly drilled into the character, and he shows a simplistic dedication to the God-Emperor that could impress even the strictest Drill Abbot. While his understanding of the Imperial Creed is minimal, he gladly performs any task he can be convinced serves it.   |
| 5  | <b>Gentle:</b> The character is surprisingly placid for his strength and prowess. Although he fights for the Imperium as fervently as any other Ogryn, he takes on an entirely different manner outside of battle. He might develop attachments to the vermin in a camp as if they were beloved pets, or attempt to lead his squad in sing-alongs of battle hymns.                        |
| 6  | <b>Loyal:</b> The character is fiercely loyal to his friends in the squad, and trusts his brothers-in-arms without question. He may be especially close to only one or two other squad mates, or he could have a tendency to "adopt" others as honorary squad members.  |
| 7  | <b>Noise-Loving:</b> Few things excite the character as much as the thunder of artillery or the rattle of automatic fire. When outside of battle, he has a tendency to bellow any messages, or simply shout to himself for the sheer joy of it. The regiment's cooks live in dread of him getting his hands on any pots or pans they need.  |
| 8  | <b>Recalcitrant:</b> Although Ogryns have a reputation for unquestioning dedication and obedience to orders, there are always exceptions to such rules. The character is one such exception, as he is convinced of his own simple wisdom, and rarely listens to any order he does not find appealing without first being threatened or cajoled to do so.                                  |
| 9  | <b>Single-minded:</b> The character has an impressive stubborn streak, even for an Ogryn. His dense skull does not seem to have room for more than one idea at a time, and changing his course away from whatever currently fixates him requires incredible patience. Even the threat of punishment might not deter him, as the character often fails to pick up on such outside details. |
| 10 | <b>He's a Clever 'un!:</b> Roll again on <b>Table 3-21: Demeanours</b> in the <b>ONLY WAR</b> Core Rulebook.  |

## RATLING COMRADES

Ratling Comrades are only available if the Player Characters select the Unusual Companion Talent, as detailed on page 108. In such a regiment, all standard Comrades are replaced with Ratling Comrades, both at character creation and when replacing casualties in the squad. Ratling Comrades follow all normal rules for Comrades except where listed below.

- Ratling Comrades are less inclined to deal with pain and injury than most Guardsman, as their smaller frames can only take so much punishment. When a Ratling Comrade becomes Wounded in combat, the controlling Player Character must make an **Ordinary (+10) Command Test**. If he fails, the Ratling Comrade immediately goes to ground as he had received the Take Cover! Generic Order, and does not respond to any Orders or take any Actions that expose him to further danger for the rest of the encounter.

- Ratling Comrades are adept at finding convenient nooks and crannies for shelter against incoming fire. When benefitting from the Take Cover! Generic Order, a Ratling Comrade is not Wounded unless the Damage of the attack exceeds 6 + the AP of the Comrade's cover. This benefit also applies to Comrades who hide after being Wounded, as detailed above.
- If anything ever happens to a Ratling Comrade that requires information from a profile, refer to the Ratling Profile on page 373 of the **ONLY WAR** Core Rulebook.
- Ratling Comrades roll for their Demeanour on **Table 3-11: Ratling Demeanours**. At the GM's discretion, a player may pick any Demeanour for his Comrade except for "**Just One of the Lads**" instead of rolling on the table.

TABLE 3-11: RATLING Demeanours

1d10

Roll Demeanour

1	<b>Adventurous:</b> The character is filled with one of the traits least favoured by the Imperial Creed—curiosity. Fortunately for both himself and the Imperial Guard, he is content to channel his interest in the unknown into reconnaissance and intelligence efforts whenever they are available, so long as he is able to travel somewhere new and view something he has not yet seen.
2	<b>Belligerent:</b> Whether he has been the butt of one too many jokes about his height or simply has a full-sized dose of aggression in his half-sized body, the character is always ready for a fight. He can be set off easily, and when people tread carefully around him, he goes looking for trouble instead.
3	<b>Crooked:</b> There is no greater delight for this character than fleecing some unsuspecting mark of all they had. Whether he gambles at bones with weighted dice or makes a habit of falsifying requisition forms with officers' signatures, he dances gleefully on the precipice of serious disciplinary action. Usually his sharp wits keep him out of trouble, but sometimes he might need backup (or an alibi) from his squad mates.
4	<b>Daring:</b> No foe or battle seems to deter this character. He faces down charging xenos monstrosities as fearlessly as the drunken belligerence of Ogryns in his camp. If he has any reaction to danger, it is to volunteer for assignments that give him a chance to spit in its eye and pour las bolts into whatever deadly threat he must face.
5	<b>Gluttonous:</b> Even those familiar with the epicurean reputation of Ratlings are likely to be astounded by the characters boundless appetite for food and drink. He might linger long over a single morsel of his rations or devour them in moments, but the moment he is done eating, he is ready to seek out more. If the regiment has permission to indulge in alcoholic refreshments, he is frequently drunk, and he is likely to distil illicit liquor.
6	<b>Roamer:</b> Wherever the character might be one moment, he is unlikely to be there for long. Something between wanderlust and a restless energy drives him to stay in motion whenever possible. If assigned to a sniper's perch, he is likely to spend hours or even days hunting for the best angle before he is willing to lay in wait. When assigned to scouting duties, he might stay out beyond the required time or roam farther afield than mission parameters dictate.
7	<b>Sharp:</b> Very little gets by this character. His eyes and his mind are both extraordinarily quick, and he is adept at using both to pick up on hidden details. Despite his natural gifts, the character is not lazy, and works hard to ensure that he has as much information as possible before deploying. Thanks to his clever mind, a good briefing can be as potent a weapon as his trusty lasgun.
8	<b>Slacker:</b> There are few who can make this character do more than the bare minimum of work. He attempts to pawn off whatever duties to which he has been assigned onto his squad mates, sometimes promising them future favours he never intends to repay. When he cannot avoid work, he does it as quickly as possible, although he is at least smart enough to do it adequately to avoid having to repeat the job.
9	<b>Sly:</b> Anyone interacting with the character typically gets the feeling of being laughed at, as he is always smiling at some private joke. Sometimes he is overcome with his own cleverness and it spills out into a more serious prank, although he stops short of anything that could trigger disciplinary action. Despite this, his squad mates are glad for his wry wit keeping their morale up in tense situations.
10	<b>Just One of the Lads:</b> Roll again on <b>Table 3-21: Demeanours</b> in the <b>ONLY WAR</b> Core Rulebook.

## SERVITOR COMRADES

Servitor Comrades are only available to characters with an appropriate Speciality or Advanced Speciality, such as the Tech-Priest Engineer from the **ONLY WAR** Core Rulebook. Such Specialities detail whether they possess Servitor Comrades, along with any relevant details of their acquisition. Basic rules for Servitor Comrades can be found on page 99 of the **ONLY WAR** Core Rulebook. Further expansions to these rules and various customisation options for Servitor Comrades are listed below:

- All Servitor Comrades are constructed along the principles of an ancient STC pattern that defines their role. When acquiring a new Servitor Comrade, whether through an Advance or when replacing casualties, a Player Character must select a Servitor Pattern from those listed below. Servitor Patterns require the Player Character to have a minimum Logistics Rating to be able to requisition such a Comrade. The Servitor Comrade granted at character creation to the characters in the Tech-Priest Engineer Speciality is an exception to these rules, as it is always a Lathe-Pattern Multitask Servitor.
- Servitor Comrades lack any sort of independent will, and never take any Actions without being directed to do so. The sole exception to this is that Servitor Comrades move to stay in Cohesion with their controlling Player Character unless directed to do otherwise.
- Servitor Comrades automatically pass all Fear and Pinning Tests, although they follow a fleeing or Pinned Player Character as normal.
- Servitor Comrades have a limited capacity for new information, and do not adapt well to circumstance. As such, they can only benefit from Generic Orders, Servitor Directives, or Orders that specifically mention Servitor

Comrades. Certain Servitor Patterns are further restricted from specific Generic Orders due to limitations of their armament or combat protocols.

- Although Servitor Comrades lack a mind or personality, they can pick up anomalous behaviours during their construction and maintenance rites. Servitor Comrades roll on **Table 3–12: Servitor Quirks** in place of selecting a Demeanour.

### SERVITOR PATTERNS

The Servitor Patterns available for Servitor Comrades are listed below, including the requirements to acquire each Pattern and the Servitor Directives used to control each Pattern. Servitor Directives listed as default are granted for no XP cost when the Comrade is acquired, while those listed as Advances must be purchased as normal.

#### Clipaeus-class Combat Servitor

**Minimum Logistics Rating:** 50

**Default Servitor Directive:** Attack Pattern Gladius Ultra

**Servitor Directive Advances:** Interdiction Manoeuvre Pattern

**Details:** The rare and valuable Clipaeus-class Combat Servitor is typically reserved for Tech-Priests who have proven their worth to the Lathes. The Lathes Mechanicum maintains limited reserves of these servitors to assign as protectors to those of those attached to the Imperial Guard who have similarly proven themselves as assets to the efforts of the war effort on the Spinward Front. The Tech-Priests granted the protection of a Clipaeus-class servitor find no better guardian for their work on the battlefield, as the whole of the pattern's advanced construction is geared towards delivering lethal retribution upon would-be assailants. Although armed with a deadly electro-gladius, its greatest value is in the protective

### PRAETORIAN SERVITOR CHASSIS

**Minimum Logistics Rating:** +20

**Default Servitor Directive:** Special

**Servitor Directive Advances:** Special

**Details:** The rare and powerful Praetorian Servitors are not a class or pattern unto themselves, but a classification for the most powerful and heavily armed combat servitors constructed by the Lathes. They are typically formed from the bodies of mind-scrubbed Ogryns or gene-bloated vat bulks rather than ordinary humans, and some have tracked units or wheels replacing their legs to assist in bearing the load of their heavy weapon systems.

The Praetorian Servitor Chassis can be applied as an upgrade to any Pattern noted as a Combat Servitor or Gun Servitor. Acquiring a Praetorian as a Servitor Comrade increases the minimum Logistics Rating required by 20 (so a Praetorian version of a Pugnis-class Combat Servitor could not be acquired by any character with a Logistics Rating of less than 30). Praetorian Servitors gain the following benefits.

- Praetorian Servitor Comrades are extremely robust, and have an additional Wound State. They can be Healthy, Lightly Wounded, Heavily Wounded, or Dead. Furthermore, they suffer no penalties for being Lightly Wounded, although they suffer the effects of being Heavily Wounded as normal.
- Praetorian Servitor Comrades based on a Servitor Pattern designated as a Combat Servitor grant their controlling Player Character an additional +10 bonus to Weapon Skill Tests when using the Close Quarters Generic Order.
- Praetorian Servitor Comrades based on a Servitor Pattern designated as a Gun Servitor grant their controlling Player Character an additional +10 bonus to Ballistic Skill Tests when using the Ranged Volley Generic Order.
- Should the Game Master or a Player require a profile for a Servitor Comrade, refer to the Servitor Profile on page 373 of the **ONLY WAR** Core Rulebook, and apply the following adjustments: +15 WS, +15 BS, +15 S, +10 T, and add the Size (5) Trait.

TABLE 3-12: SERVITOR QUIRKS

1d10

Roll Quirk

1	<b>Ancient Technology:</b> One or more of the servitor's mechanical components shows signs of ancient and superior craftsmanship. These components have likely been installed on countless previous servitors, and should be preserved at all costs for continued use. Losing this ancient technology would be viewed most unfavourably by the upper echelons of the Adeptus Mechanicus.
2	<b>Blank Slate:</b> This servitor has little in the way of distinguishing features, appearing as an archetypal example of its kind. Despite the clear wear and tear of many years of use, it has not developed any irregularities, flaws or other distinguishing characteristics.
3	<b>Logis-Cortex Irregularity:</b> The logis-cortex that governs the servitor's thoughts has developed or was constructed with anomalous behaviours. Certain biological behaviour remnants that should be suppressed by the logis-cortex are still active, causing the servitor to follow human activity with its gaze or engage in stuttered attempts at handshakes, waving, or other greetings when presented with new faces.
4	<b>Misshapen Grafts:</b> Whatever criminal or menial was sentenced to become this servitor was deficient in the necessary muscle mass, necessitating the addition of vat-grown augmentations. The grafts are obvious to even a casual inspection, and provide the servitor with a grotesque bulk more reminiscent of an Ork Nob than the condemned soul who provided its body.
5	<b>Ornate Craftsmanship:</b> Elaborate engravings and embellishments adorn every plate and motor on the servitor, demonstrating an unusual flair on the part of its creator. They may be etchings of the dogma of the Cult Mechanicus, or icons of victory and Imperial power to impress the soldiers serving in its presence. Its master must devote much of his maintenance time to preserving the careful artistry of these adornments unblemished, or risk angering the machine spirits housed within.
6	<b>Recent Manufacture:</b> The servitor was produced with components recently produced from a manufactorum in the current twilight days of the Imperium, rather than using reclaimed elements of older technology. While the complete set of purpose-built components is free of any degradation, it also lacks any of the sophistication common to older models.
7	<b>Servo-muscle Impulse Stutter:</b> A flaw deep in the servitor's machine components induces an odd stuttering in the motions of its heavy servo-assisted muscle. These spasms and jerks make the servitor occasionally unreliable in particularly delicate work, but more typically amount only to a disturbingly halting motions and actions.
8	<b>Sturdy Construction:</b> The servitor was assembled with a solid, no-nonsense approach. Although squatly built and lacking in any sort of ornamentation beyond the most basic maker's mark, it nonetheless demonstrates its creator's methodical care with every snugly-fitting mechanism, as well as along every flawless seam of the solidly-installed plating. Maintenance rites for the servitor are inevitably quick and easy, as little short of heavy weapons fire mars its exceptional functioning.
9	<b>Unsettling Visage:</b> Sometimes a servitor slips through the assembly process with what would seem a glaring flaw to those more concerned with the trivialities of flesh than its Tech-Priest creator. The servitor may have enough of its face perfectly preserved to render it disturbingly human, with a visible expression of alarm or pain. Alternately, it may have little left of its face or skin at all, being crafted from the repurposed flesh of a careless manufactorum worker. The end result is a horror to behold for Guardsmen and their enemies alike.
10	<b>Vat-Grown:</b> Unlike many of its kind, this servitor's flesh never originated with a true-born human body, but was grown in a nutrient tank for the express purpose of its current state. Its native forge world may specialise in such processes, or may have been undergoing a population shortage at its time of construction that temporarily required such measures. Imperfections in the vat-growth process may have marked the servitor, requiring greater cybernetic replacement or leading to peculiar deformities.



field generator that allows it to shrug off deadly blows again and again over the course of continued service. A serious assault can briefly overwhelm the field, but few enemies survive long enough to exploit this vulnerability.

For the purpose of carrying out Attack Orders, a Clipaeus-class Combat Servitor has a Weapon Skill of 40, or a Weapon Skill of 55 if it has the Praetorian Servitor Chassis upgrade. The integrated electro-gladius used in its Attack Orders has the following profile (Melee; 1d10+10; Pen 5; Power Field, Shocking). Thanks to the protection of its integrated field generator, a Clipaeus-class Combat Servitor ignores the first hit it would suffer each combat encounter. Note that since the combat protocols of the Clipaeus-class dictate close attack patterns as its sole mode of engagement, a Clipaeus-class Combat Servitor cannot participate in the Ranged Volley Order.

### Incendio-class Gun Servitor

**Minimum Logistics Rating:** 25

**Default Servitor Directive:** Flame Sweep Initiation

**Servitor Directive Advances:** None

**Details:** The Incendio-class Gun Servitor is a favourite of Enginseers assigned to the trenches of the Spinward Front, where a gout of burning promethium can turn the tide of a battle. It mounts a flamer integrated in place of its right arm, and stores the fuel in an armoured compartment in the lower torso—a design that limits the vulnerability of such a volatile fuel source to enemy fire. When directed to the fore of the squad, the Servitor can engage its flame to flush the enemy from cover or out of bunkers, or simply roast them where they stand.

This Servitor pattern is equipped with an integrated flamer (detailed on page 175 of the **ONLY WAR** Core Rulebook). This weapon is used in the Flame Sweep Initiation directive detailed on page 117.

### Jovian-pattern Gun Servitor

**Minimum Logistics Rating:** 35+

**Default Servitor Directive:** Heavy Firepower Assault

**Servitor Directive Advances:** Heavy Suppression Barrage, Precision Firepower Delivery

**Details:** The Jovian-pattern Gun Servitor has been a mainstay of the Lathe Worlds' fighting forces for millennia, having been employed to defend Enginseers on the field of battle, and in a variety of other roles since the foundation of the Calyx Expanse. Its STC pattern is ancient and revered, and the heavy firepower of the Jovian-pattern fabricated in the Lathes has heralded victories throughout the Calixis Sector. The pattern is defined by its durable construction, heavy power supply, and massive integrated weapon systems. The entirety of the servitor is carefully constructed to optimise firepower for its main gun.

When acquiring a Jovian-pattern Gun Servitor, the controlling Player Character must select a single weapon from the list below for its integrated main gun. Profiles for these weapons can be found in **Chapter VI: Armoury** of the **ONLY WAR** Core Rulebook. Some options stretch even the impressive versatility of the Jovian-pattern chassis, and



require a greater minimum Logistics rating to acquire the appropriate upgrades.

- Minimum Logistics Rating 35: M41 multi-laser
- Minimum Logistics Rating 40: Multi-melta, Heavy bolter
- Minimum Logistics Rating 50: Man portable lascannon, Plasma cannon

For the purpose of carrying out Attack Orders with its main weapon, a Jovian-pattern Gun Servitor has a Ballistic Skill of 40, or a Ballistic Skill of 55 if it has the Praetorian Servitor Chassis upgrade.

### Lathe-pattern Breacher Servitor

**Minimum Logistics Rating:** 15

**Default Servitor Directive:** Barrier Removal Process

**Servitor Directive Advances:** Armour Negation Protocols

**Details:** Although most commonly deployed to mining colonies, the Lathe-pattern Breacher Servitor also sees considerable combat use among sappers and siege regiments. The adamantium-tipped drills replacing its hands serve just as well in forcing entry to enemy strongholds as they do in unearthing ore deposits far from the front lines. Tech-Priests well-versed in the rites of servitor cogitation mechanisms sometimes find it appropriate to develop protocols for applying the drills to smaller-scale clashes as well, allowing them to direct the piercing bite of the drills at heavily armoured enemies. By this means, a Breacher Servitor can be the bane of not only a fortress wall, but the elite troops guarding it.

This Servitor pattern is equipped with diamond-tipped breaching drills used in its Barrier Removal Process Directive detailed on page 116.

### Lathe-pattern Multitask Servitor

**Minimum Logistics Rating:** 5

**Default Servitor Directive:** None

**Servitor Directive Advances:** None

**Details:** The Lathe-pattern Multitask Servitor is one example of a number of common varieties of servitors designed to serve as a general assistant to Engineers in the field. Although it lacks the dedicated specialities of a more purpose-built servitor, its versatility is invaluable when dealing with the chaotic theatres of war that Adeptus Mechanicus personnel must endure in support of the Imperial Guard.

This servitor pattern is imprinted with advanced cogitator functions that allow it to follow complex instructions and operate in a wide variety of circumstances. As such, a Lathe-Pattern Multitask Servitor can benefit from any Order that its controlling Player Character issues, rather than being restricted as normal for Servitor Comrades. Note that this is the basic Pattern of servitor acquired as a companion by the Tech-Priest Engineer Speciality in the **ONLY WAR** Core Rulebook.

### Calyx-pattern Task Servitor

**Minimum Logistics Rating:** 5

**Default Servitor Directive:** None

**Servitor Directive Advances:** None

**Details:** The Calyx-pattern Task Servitor is one of the most commonly seen pieces of technology in the Calixis Sector, possessing thousands of variants and sub-patterns produced on Forge Worlds across the region. At its essence, the design is for a servitor utterly devoted to performing a single technical

task with the utmost specialisation. The Engineers attached to combat regiments are often granted the use of one of a number of sub-patterns designed for maintenance and repair of military equipment.

Player Characters making Tests to operate or repair the vehicles or equipment with the assistance of a Calyx-pattern Task Servitor gain an additional +10 Bonus. However, the servitor lacks any means of attacking enemies, and has next to no capacity for adapting to weaponry installations. The Calyx-pattern Task Servitor cannot participate in the Close Quarters or Ranged Volley Orders.

### Pugnis-class Combat Servitor

**Minimum Logistics Rating:** 10

**Default Servitor Directive:** Attack Pattern Pugnis Furioso

**Servitor Directive Advances:** None

**Details:** Pugnis-class Combat Servitors are commonly used as a combination bodyguard and shock troop by the soldiers and auxiliaries of the Adeptus Mechanicus. Its robust frame is equipped with two massive servo-fists that can pummel apart even the hardiest enemies. Many Tech-Priests placed on the front lines of battle owe their lives to the impressive strength these Servitors wield in their defence. The most martially inclined among the Red Priesthood sometimes gather groups of these servitors together for assaults on enemy positions.

The combat protocols of the Pugnis-class dictate close attack patterns as its sole mode of engagement, so a Pugnis-class Combat Servitor cannot participate in the Ranged Volley Order.

*Lathe-Pattern Multitask Servitor*



*Calyx-Pattern Task Servitor*



# EXTENDED ARMOURY

*"I come here not to deliver the Emperor's Word, only to deliver His justice!"*

—Priestess Corsinia Vey, moments before the burning of Camp 224-Y

There is no end to the variety of weapons within the Imperial Guard. From the smallest of compact laspistols to the mightiest anti-Titan weapons, the Forge Worlds of the Adeptus Mechanicus push out an endless array of deadly munitions that the Imperial Guard uses every day to defend and restore the glory of the Imperium one blood-soaked step at a time.

This section covers a number of weapons and technologies found in the hands of some of the more specialised Imperial Guard forces within the Spinward Front, as well as an expansive list of vehicle mounted weapons, ordnance and upgrades common throughout the Imperium.

## RANGED WEAPONS

The Imperial Guard is such a vast and varied organisation that cataloguing each individual weapon type or environmental adaptation would be next to impossible for even the most organised members of the Departamento Munitorum. For every standard piece of equipment seen within Calixis Sector and on the battlefields of the Spinward Front, there are many more specialised weapons hardly seen elsewhere within the Imperium, each one more dangerous than the last.

## INTEGRATED WEAPONS

Rare and scarcely understood by the forces of the Imperial Guard, the integrated weapons wielded by the mysterious Crimson Guard give these red-robed warriors a distinct advantage over standard wargear. Part weapon system and part cybernetic implant, the user's potentia coil powers the weapon, giving it a near-endless amount of energy to draw from. This removes the usual logistical problems most Guard regiments encounter. Rarely seen on the Spinward Front, these arcane weapons have left a fearsome impression on those Guardsmen lucky enough to have served the Crimson Guard.

**Upgrades:** Any Basic or Pistol Las, Flame, Melta, and Plasma weapons or any Melee weapons

## Integrated Weapons Rules

Integrated Weapons link to and draw power from the potentia coil (see the Mechanicus Implants Trait, page 156 of the **ONLY WAR** Core Rulebook), and as such only those that possess this implant may use this type of weapon. Whenever an integrated weapon would suffer a Jam the user instead takes 1 Level of Fatigue as the drain on their own potentia coil starts to wear them down.

Integrated weapons are always physically linked to their user, and cannot be dropped or discarded without first being disconnected. Disconnecting and reconnecting requires an

**Ordinary (+10) Tech-Use Test** and is a Half Action with the Concentration Subtype.

To use integrated weapons, a character must have Exotic Weapon Training (Integrated Weapon).

## Creating Integrated Weapons

In addition to the effects listed above, certain kinds of weapons gain additional benefits when made into Integrated Weapons, as detailed below:

- Integrated las weapons have unlimited ammunition and never need to reload.
- Integrated flame, plasma, and melta weapons double their standard Clip Size. Additionally, integrated plasma weapons can still Overheat, but lose the Recharge Quality as long as they remain connected.
- Integrated chain weapons gain the Razor Sharp Quality.
- Integrated shock weapons inflict an additional –30 Penalty on Toughness Tests to resist their effects.
- Integrated power weapons increase their Damage and Penetration by +2.

Upgrading a weapon to an integrated weapon follows the standard rules for weapon upgrades (see page 188 of the **ONLY WAR** Core Rulebook) except that the character attempting to upgrade the weapon must have the Forbidden Lore (Adeptus Mechanicus) Skill before he can attempt the Test. The components required to create Integrated Weapons are typically only available on Forge Worlds.

## Disconnected Integrated Weapons

Whenever an integrated weapon is disconnected it quickly loses the benefits of its power source. The weapon retains a residual charge, but this quickly fades. Ranged integrated weapons gain a clip size of 1d10+4, and once the remaining shots have been fired it cannot be fired again until it has been reconnected. Disconnected integrated weapons can Jam, and if this occurs they lose all their remaining ammunition immediately. Integrated melee weapons lose all power within 1d5+3 rounds and revert to a low-tech weapon of the same type (eg. an Integrated power sword will be treated as a standard sword once its power has drained). Integrated weapons only regain their special benefits once reconnected.

## Reconnecting Integrated Weapons

Once a disconnected integrated weapon has been reconnected to a potentia coil it regains all its usual benefits. If an integrated weapon cannot be reconnected it can be manually charged if the character has access to an external power source. This requires a **Hard (–20) Tech Use Test**, and grants an integrated ranged weapon an additional 1d10+4 shots or gives an integrated melee weapon 1d5+3 additional rounds of power before they cease operating again. If the character attempting the Tech-Use Test fails by two or more Degrees of Failure, the attempt has damaged the weapon, rendering it useless.

TABLE 3-13: WEAPON UPGRADES

Name	Weight	Availability
Integrated Weapon Components	+0.5 kg	Extremely Rare

TABLE 3-14: RANGED WEAPONS

Name	Class	Range	RoF	Dam	Pen	Clip	Rld	Special	Wt.	Availability
Catalytic Mass Driver	Basic	120m	S/-/5	1d10 R	12	N/A	N/A	—	7kg	Extremely Rare
Chem Cannon †	Vehicle	40m	S/-/-	2d10+5 E	9	50	N/A	Crippling (2), Felling (2), Spray, Toxic (4)	600kg	Very Rare
“Emperor’s Will”	Pistol	60m	S/2/-	1d10+5 E	2	5	Half	Accurate, Reliable	3kg	Very Rare
Heavy Mortar	Vehicle	300m	S/-/-	††	††	1	Half	Indirect (3), Reliable, ††	400kg	Rare
Lathe-Laspistol	Pistol	40m	S/2/-	1d10+6 E	2	N/A	N/A	Tearing	2kg	Very Rare
Lathe-Lasrifle	Basic	100m	S/2/-	1d10+6 E	2	N/A	N/A	Tearing	4.5kg	Very Rare
“Longshot” †	Heavy	350m	S/-/-	††	††	1	Full	Accurate, ††	6kg	Extremely Rare
Mauler Cannon	Heavy	60m	S/2/-	3d10+8 I	6	40	2 Full	Ogryn Proof, Twin-Linked	50kg	Very Rare
Phased Plasma Rifle	Basic	100m	S/2/4	2d10 E	6	N/A	N/A	—	12 kg	Extremely Rare
Pyrophoric Vambrace †	Pistol	15m	S/-/-	2d10+2 E	4	10	2 Full	Corrosive, Flame, Spray	4kg	Very Rare
Volcano Cannon †	Vehicle	3000m	S/-/-	10d10+20 E	20	N/A	N/A	Blast (8), Felling (6), Overheats, Recharge	8000kg	Extremely Rare

† Damage, Damage Type, Pen and additional Special rules depend on ammunition used.

†† This weapon has additional rules. See entry for details.

### CATALYTIC MASS DRIVER (INTEGRATED WEAPON)

A weapon unique to the Crimson Guard, the catalytic mass driver is one of the few known integrated ballistic weapons in existence. The gun uses energy to propel tiny shards of metal at extremely high velocities, enough to tear effortlessly through most types of armour. Its high rate of fire and the distinctive snapping noise as it makes as it fires marks it as one of the most peculiar weapons on the Spinward Front.

### “EMPEROR’S WILL” OFFICER’S LASPISTOL

Mostly seen in the hands of Commissars across the Spinward Front, this unusual pattern of heavy laspistol has a fearful reputation not amongst the enemies of the Imperium, but within the Imperial Guard itself. Made for the type of Commissar who prefers precision to destruction, simply brandishing an Emperor’s Will pistol is often enough to keep wayward and cowardly infantry in line.

An Emperor’s Will laspistol grants the wielder an additional Degree of Success on any successful Intimidate Test.

### CHEM CANNON

A frightening and hazardous weapon to use, the Bane Wolf’s chem cannon is often more of a burden than a boon. Firing a dense cloud of exceedingly dangerous chemicals, some so powerful that they dissolve organic material on contact, the chem cannon is a true terror weapon. Exposed infantry die within seconds, reduced to puddles of stinking infected ooze, any survivors lurching away screaming, their bodies covered with steaming chemical burns.

After completing a chem cannon attack find the general centre of the area affected by the attack. A toxic cloud with a radius of 1d5 metres remains in place for 1d5 rounds. Any character who ends his Turn within the cloud suffers 2d10+5 Energy Damage with the Crippling (2), Felling (2), Toxic (4) Qualities. Any character who ends his Turn within the cloud also suffers the Suffocation Special Damage Condition (see page 267 of the **ONLY WAR** Core Rulebook) until he leaves the cloud or the cloud dissipates.

## HEAVY MORTAR

Despite its name, the heavy mortar is one of the smallest artillery weapons in service to the Imperial Guard. As the main armament of the Griffon artillery vehicle, the heavy mortar makes up for its lack of punch with a higher rate of fire and a broad suite of ammunition types, including the specially designed Siege Shell. In addition the specialist ammunition listed in this book, heavy mortars may also fire anti-plant rounds, smoke rounds, and starflare rounds, adding +2 to any Blast or Smoke Radiuses (or an extra minute of illumination for starflare rounds).

## LATHE-LASPISTOL (INTEGRATED WEAPON)

The smallest Integrated Weapon in service to the Crimson Guard, the integrated Lathe-laspistol possesses an excellent rate of fire and reasonable penetrative abilities.

## LATHE-LASRIFLE (INTEGRATED WEAPON)

Originally derived from an ancient archeotech design, the integrated Lathe-lasrifle packs a greater punch than regular lasguns. Whilst uncommon on the Spinward Front, the Lathe-lasrifle is the weapon most often seen in the hands of the few Crimson Guard units that serve in the fight against the Severan Dominate.

## MkXVI “LONGSHOT” SNIPER RIFLE

Rare even among Spinward Front Ratling units, the MkXVI sniper rifle, often referred to as the “Longshot,” is a small yet highly versatile ranged weapon favoured by the best Ratling marksmen. The Longshot’s main benefits stem from specialist hand-made ammunition types including explosive rounds and even high-pressure toxic gas canisters. Additionally each Longshot breaks down into a more compact pistol form, sacrificing range for ease of use in close quarters.

As a Full Action, its wield can break a Longshot into a pistol by removing the barrel and stock. The Longshot’s Range is halved and it loses the Accurate Quality. It counts as a Pistol weapon instead of a Basic weapon. Restoring the barrel and stock also requires a Full Action.

## “SIX/TWELVE” MAULER CANNON

An adaptation unique to the Spinward front, the mauler cannon is actually a modified twin-barrelled M34 autocannon designed specifically for use by Ogryns. Rebuilt with a heavier frame, shorter barrels, a fire-limiter, larger handholds, and a triple harness capable of withstanding an Ogryn’s strength, the mauler cannon gives Ogryn units an enormous boost to their firepower. Sadly mauler cannons have picked up the nickname “Six/Twelve” by regular Guardsman, referring to the number of shots an Ogryn will likely fire before they somehow break it or decide to use the weapon as a club.

## PHASED PLASMA RIFLE (INTEGRATED WEAPON)

As one of the more dangerous special issue weapons within the Crimson Guard, the phased plasma rifle does away with many of the drawbacks common to Imperial plasma weaponry, all but eliminating the needs for recharge and significantly reducing the excess heat that conventional plasma weapons tend to generate.

## PYROPHORIC VAMBRACE

Sometimes seen in the hands of those described as Incinerant Priests, the pyrophoric vambrace is an unusual and easily concealed flame weapon worn on the wrist. A long tube snakes away from the projector to a vacuum sealed case worn on the back. The case holds not promethium, as is common with most Imperial flame weapons, but various corrosive powdered metals that react explosively when exposed to oxygen. A pyrophoric vambrace has a limited range, but its unique design leaves the user’s hands free for other tasks.

The weight of the pyrophoric vambrace includes the ammunition backpack. A pyrophoric vambrace is easily concealed beneath robes and other loose clothing. Targets set on fire by a pyrophoric vambrace suffer an additional 1d10 Damage from being on fire (see page 266 of the **ONLY WAR** Core Rulebook), but the Test to extinguish the fire is Challenging (+0) rather than Hard (-20).

## VOLCANO CANNON

In the realm of ground-based warfare there are few weapons larger and more powerful than the volcano cannon. Measuring over 13 metres in length, the volcano cannon’s range and firepower make it one of the most feared and destructive weapons available to the Imperial Guard. More commonly seen on the massive God-machines of the Titan Legions, volcano cannons are also found on the Shadowword super-heavy tank, a variant of the Baneblade chassis. The Shadowword must remain stationary when the volcano cannon fires and recharges, but the effects are unmistakable; virtually nothing short of an Ork Gargant or Reaver Titan can stand up to the firepower of such an immense weapon.

The destructive force of the volcano cannon against regular infantry is nearly incalculable, and as such anything anything with a Size Trait with a value of 5 or below that suffers even a single point of Damage is instantly obliterated in a torrent of ravening flame. Against larger targets, or any vehicle with the Super-Heavy Vehicle Trait, roll Damage as normal. If it is not a Titan, the platform for the volcano cannon cannot move in the same Turn it fires, or whilst it is recharging.

TABLE 3-15: MELEE WEAPONS

Name	Class	Range	Dam	Pen	Special	Wt.	Availability
“Puritan’s Wrath” †	Melee	–	1d10+4 R	5	Sanctified, Tearing, Unbalanced	12kg	Extremely Rare
Mace-Fist	Melee	–	1d10+4 I	1	Concussive (2), Inaccurate, Ogryn-Proof	16kg	Average
Venator Blade †	Melee/ Thrown	6m	1d5+2 R	2	Balanced, Felling (2), Razor Sharp	0.5kg	Extremely Rare

† This weapon has additional rules. See entry for details.

## MELEE WEAPONS

The Imperial Guard might be well known for their overwhelming firepower, but there are still many within their ranks that prefer and even excel at close assault tactics. From fiery priests to hulking Ogryn, there is no shortage of combatants waiting to tear the Emperor’s enemies limb from limb.

The weapons below require one hand to use unless specified otherwise.

### “PURITAN’S WRATH” CHAINAXE

Made only from the finest materials the Calixis Sector has to offer, the broad-headed chainaxe commonly known as the “Puritan’s Wrath” is a true sight to behold on the battlefield. Carried into the thickest of fighting by those militant priests of the Adeptus Ministorum, the Puritan’s Wrath proudly displays the symbol of the Ecclesiarchy across its broad face whilst streams of purity seals and devotional litanies stream down its surface and around its long handle. The Puritan’s Wraith may look like an ordinary chainaxe, but many tales tell of the blade’s uncanny ability to fell heretics in a single blow, and of its supernatural ability to destroy the most blasphemous of creatures: the Daemons of Chaos.

The “Puritan’s Wrath” chainaxe requires two hands and gains the Felling (4) Quality when used against heretics, Daemons, and the forces of Chaos.

### MACE-FIST

A crude and brutal weapon, the mace-fist is actually a series of improvised weapons crafted on numerous worlds across the Spinward Front. Simple to build and use, and designed to fit around the hand of an Ogryn, these spiked metal gloves are strong enough to survive anything the Ogryn might try. Not sophisticated by any means, mace-fists emphasise uncontrolled brute strength over finesse and technology.

### VENATOR BLADE

Only ever seen in the hands of the Crimson Guard, the venator blade is a long dagger of exceptional craftsmanship. Almost impossible to destroy, the blade’s sharp edge seems to cause more damage than would normally be possible from a more mundane edged weapon.

A Venator Blade cannot be destroyed by the effects of a weapon with the Power Field Quality.

## SPECIAL ISSUE AMMUNITION

The Departamento Munitorum fields thousands of orders every day from across the entire Spinward Front for various ammunition types. With combat theatres as wild and varied as the adversaries that hold them, the Imperium maintains hundreds of specialised ammunition and ordnance patterns that can often be the difference between victory and defeat.

### LONGSHOT AMMUNITION

Hand built and hard to obtain, the specialist ammunition used in the MkXVI “Longshot” sniper rifle features a heavy gas cartridge that reduces noise and all but eliminates muzzle flare. Longshot ammunition comes in packs of 5 individual rounds.

### Penetrator Slug

Designed to punch through personal armour with ease, penetrator slugs are perfect for taking out single targets of high value such as officers, artillery crew and specialist troops.

### Explosive Slug

Designed to explode on impact, explosive slugs mimic the effects of frag grenades, but over a much longer distance.

### Flash Slug

Based on a similar concept to the explosive slug, the flash slug sends out a short pulse of blinding light and sparks, disorientating foes from afar. Hits from a flash slug do no damage, but cause everyone within 5 metres of the impact to Test for Blindness in the same way as a photon flash grenade. (see page 183 of the **ONLY WAR CORE** Rulebook).

### Toxin Slug

Hard to manufacture and even harder to aim, toxin slugs sacrifice range due to their heavy construction. However the brutal effects of even a single slug make the sacrifice worthwhile. Toxin slugs halve the range of the Longshot, and gain no benefit from the Accurate Quality.

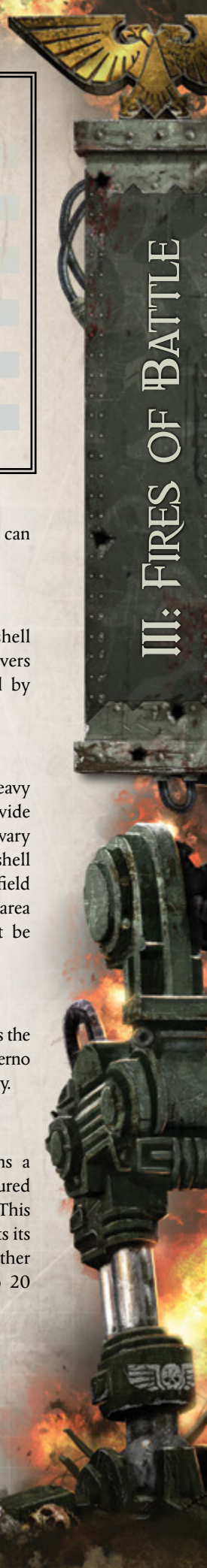

TABLE 3-16: SPECIAL ISSUE AMMUNITION

Name	Dam	Pen	Special	Wt.	Availability
Penetrator Slug	1d10+3 I	4	Proven (4), Razor Sharp	–	Very Rare
Explosive Slug	2d10 X	0	Blast (2)	–	Very Rare
Flash Slug†	–	–	Blast (5)	–	Very Rare
Toxin Slug	1d10+1	2	Blast (1), Corrosive, Toxic (2)	–	Extremely Rare
Manticore Missile	4d10+12 X	12	Blast (15+1d10), Concussive (5)	4000kg	Rare
Storm Eagle Rocket	6d10 X	4	Blast (10), Concussive (6)	4500kg	Very Rare
Sky Eagle Rocket	4d10+12 X	12	Proven (4)	4000kg	Very Rare
Heavy Frag Shell	3d10 X	5	Concussive (3), Blast (8)	3kg	Common
Heavy Minefield Shell	2d10 X	1	Blast (1)	3kg	Rare
Infernus Mortar Shell	2d10+4 E	2	Blast (8), Flame	3kg	Rare
Siege Shell †	2d10+6 X	10	Concussive (2), Blast (3)	3kg	Very Rare

† This ammunition has additional rules. See entry for details.

## MANTICORE AMMUNITION

Manticores must have four of the same ammunition type chosen from the options below:

### Manticore Missiles

Easily the most common type of warhead used by the Manticore, the standard manticore missile has an enormous blast radius and can tear infantry and heavy vehicles apart with ease.

### Storm Eagle Rockets

A slightly longer rocket that is gaining popularity among Spinward Front artillery crews stationed on worlds with heavy Ork populations, the Storm Eagle Rocket deploys multiple smaller warheads that lack the penetrative capabilities of the standard missiles but more than make up for it with their explosive yield. Once the final hit location for a Storm Eagle rocket is determined, the Guardsman that fired it should scatter 1d5 additional hits 2d10 metres away from the initial hit. Once the location of every hit has been determined resolve Damage as normal.

### Sky Eagle Rockets

Sky Eagle rockets change the mission capabilities of the Manticore from heavy ground suppression to anti-air support. Sky Eagle Rockets are lethal weapons that track their targets with surprising accuracy, making them far more effective than most “spray and pray” anti-aircraft weapons. Sky Eagle rockets do not have the Indirect (4) Quality and may not be fired Indirectly. They can be fired directly at ground targets, but suffer a Ballistic Skill penalty of –30 when used in this manner.



## HEAVY MORTAR SHELLS

Only heavy mortars, such as the one found on page 127, can use the following shells.

### Heavy Frag Shells

The standard shell of the heavy mortar, the heavy frag shell lacks the punch of the bigger Earthshaker shell, but covers a much wider area than the standard frag shells used by regular mortars.

### Heavy Minefield Shell

Most often used to block enemy infantry movement, heavy minefield shells scatter multiple sub-munitions across a wide area. The mines are hard to see and easily catch the unwary underfoot with lethal consequences. A heavy minefield shell creates a minefield 1d10 metres in diameter. This minefield remains in place until ten mines have exploded, or if the area is cleared by a minesweeper. Mine detonations cannot be Dodged unless the victim is aware he is in a minefield.

### Infernus Mortar Shell

Much like the heavy frag shell, the infernus mortar shell lacks the punch of standard sized infernus shells, but the roaring inferno that follows is no less dangerous to lightly armoured infantry.

### Siege Shell

A shell unique to the griffon, the siege shell contains a specialised fuse that detonates only after it has punctured the hard exterior of an enemy fortification or building. This makes the round excellent at destroying bunkers, but limits its use against standard targets. When fired at buildings or other fortifications the siege shell increases its Penetration to 20 and inflicts an extra 2d10 Damage.

TABLE 3-17: ARMOUR & FORCE FIELDS

Name	Locations Covered	AP	Protection Rating	Wt	Availability
Crimson Armour	All	6	–	6 kg	Near Unique
Light Power Armour	All	7	–	40 kg	Near Unique
Power Armour	All	8	–	65 kg	Near Unique†
Rosarius ††	All	–	50	0.6 kg	Very Rare
Sanctified Vestments††	Arms, Body, Legs	5	–	12kg	Rare

† *Engineers treat the Availability of power armour as Extremely Rare.*

†† *Ministorum Priests only.*

## ARMOUR & FORCE FIELDS

Most Imperial Guard regiments never receive anything more than their basic flak armour. Some might be lucky to secure rigid plates to augment their armour, and some well-equipped regiments hail from worlds where sturdy Carapace Armour is the norm, but for the most part a Guardsman faces the enemies of the Imperium with little to protect himself beyond his faith in the Emperor. For the true elite, however, there are armour types far and beyond even the best suits of Carapace, suits of armour that can turn the blow of a rampaging Ork or stop dead the shot of a traitor's lasgun. Few possess the means to procure these prestigious forms of protection, but they are always worth the cost.

### CRIMSON ARMOUR

Guardsmen across the Spinward Front that witness the Crimson Guard in action always recount the sense of dread that seems to surround them. Much of this horrific feeling stems from the Crimson Guard's standard issue armour. Expertly engineered within the Lathes of the Calixis Sector the armour is not only intimidating in appearance, but conceals numerous additional systems that give even lone Crimson Guardsmen an edge in combat.

Crimson armour comes equipped with a Good Quality photo-visor and grants the wearer the Unnatural Strength (1) Trait (or increases the value of this Trait by 1). Crimson armour is environmentally sealed as long as the helmet is worn.

### LIGHT POWER ARMOUR

Light power armour, whilst still incredibly rare, is more common than full suits of power armour. Each suit of light power armour offers similar protection to more complete suits, and has roughly half the strength enhancing and auto-sense equipment common to the larger suits.

Light power armour follows the same rules as power armour for powering the suit. A character wearing light power armour gains the Unnatural Strength (1) and Unnatural Perception (1) Traits (or increases the value of these Traits by 1). Power armour is environmentally sealed as long as the helmet is worn.

### POWER ARMOUR

Associated more with the Adeptus Astartes than with the Imperial Guard, power armour is issued only to officers of great renown. Power armour augments strength, provides a sophisticated auto-senses suite and has numerous other sub-systems that make each suit incomparable to standard issue equipment. Tech-Priest Engineers sometimes enter combat in deep red suits of power armour, the greater protection allowing them aid the machines of war during the heat of battle whilst remaining safe from toxins, gasses and most small arms fire.

The power armour supplied to those with the Mechanicus Implants Trait draws its power from the wearer's potentia coil, effectively granting it a limitless power source. On those rare occasions that an unaugmented hero is honoured with a suit of power armour, it is fuelled by an external power pack good for 1d5 hours of rigorous combat use.

A character wearing power armour gains the Unnatural Strength (2) and Unnatural Perception (2) Traits (or increases the value of these Traits by 2) and increases the value of his Size Trait by 1 (usually to Size [5]). Power armour is environmentally sealed as long as the helmet is worn.

### ROSARIUS

A Rosarius is a badge of faith incorporating a powerful conversion field generator. Gifted to respected priests of the Ecclesiarchy, they are as much a sign of purity and the Emperor's favour as they are a defensive item. This clear sign of the God-Emperor's blessing serves to hearten the warriors of the Imperial Guard.

A rosarius contains a Force Field with a Protection Rating of 50. Allies within 10 metres of a Ministorum Priest with a rosarius gain a +10 bonus to Fear and Pinning Tests.

### SANCTIFIED VESTMENTS

This broad category of reinforced clerical garments encompasses everything from the armour-plated robes of a battle-friar to the artfully woven mantle of an itinerant missionary. There is no uniform pattern or method of creation for these garments and each is particular to its wearer or the Ministorum facility at which it was crafted.

## CYBERNETICS

The Lathe Worlds supply the Spinward Front with endless streams of weapons, tanks, artillery and every other imaginable mechanical creation. However the Mechanicum reserves the very best of this equipment for their own agents, ensuring that these technological marvels of a lost age remain only in the hands of those capable of showing them proper care and respect.

TABLE 3-18: CYBERNETICS

Name	Availability
Alatus-Pattern Jump Pack	Extremely Rare
Servo-Claw	Very Rare

### ALATUS-PATTERN JUMP PACK

Drawing power directly from a potentia coil, the Alatus-pattern jump pack links directly into the user's nervous system allowing for far greater control than more mundane jump packs. Often taking the form of a sweeping pair of intimidating mechanical wings, the Alatus is a common sight among the elite of the Crimson Guard and it is a frightening sight indeed to see even a single Crimson Guardsman darting about the battlefield with such lethal precision.

The Alatus-pattern jump pack doubles the user's base movement value and can be used to gain the Flyer (12) Trait for up to one minute. Extended flights tend to drain potentia coils far quicker than short jumps, so the user must pass a **Challenging (+0) Toughness Test** after using the Flyer Trait or gain one level of Fatigue. The mechanical wings grant the user the Fear (1) Trait, and can be used to buffet the enemy in combat, granting the user a +10 to all Parry Tests. Use of the Alatus-pattern jump pack requires the Operate (Aeronautica) Skill and the Mechanicus Implants Trait.

### SERVO-CLAW

The designs of most Mechanicum technologies, such as manipulator mechadendrites and servo-arms, have a specific practical purpose in mind and any use they might have as a weapon is often incidental. The servo-claw is the opposite of that, a form a mechadendrite designed purely for its combat. Consisting of tightly wound bundles of synthetic muscle fibres, the small metal frame ends in a sharp serrated claw that can cut through armour and snap bones with remarkable ease.

A servo-claw is usually mounted at waist height as not to interfere with the movement of the arms or any other mechadendrites. A servo-claw has the following profile: Melee; 1d10+10 I; Pen 4; Tearing. The user can use it to make attack actions as normal. He can also spend a Reaction to make a Standard Melee Attack Action with the servo-claw. The servo-claw never adds the user's strength to its Damage. The servo-claw can lift objects using its Strength of 50 and Unnatural Strength (+5) Trait. The Mechadendrite Use (Manipulator) Talent applies to the servo-claw.

## VEHICLE UPGRADES

It is rare to see two Imperial Guard tanks that are exactly alike, even within the same company. Smoke launchers, pintle-mounted weapons, track guards and even basic searchlights appear in numerous configurations and come in all manner of different patterns. Most are common and easy to install by a skilled Operator or Engineer. Others are more integral however, and are often installed during the vehicles manufacture.

There are two types of vehicle upgrades—Standard and Integral. Standard vehicle upgrades are optional additions that Guardsmen can requisition just like other equipment. If no one is on hand to install the upgrade then the Guardsmen can do it themselves just as if they were Repairing the vehicle (see **Damage & Repair** on page 281 of the **ONLY WAR** Core Rulebook). Integral vehicle upgrades cannot be added to a vehicle; the vehicle must come with that upgrade from the start. The GM has final say on what Integral Vehicle Upgrades the players might have when they are assigned a vehicle, and Regiments with access to higher quality equipment should generally have access to better upgrades. All vehicle upgrades have an associated Difficulty Rating with the base Difficulty of the Test to repair them; for Standard Vehicle Upgrades, this Difficulty Rating the base Difficulty for installation. A vehicle can only have one instance of any given upgrade at a time.



## ABLATIVE ARMOUR

**Type:** Standard

**Upgrades:** Any Vehicle

**Install/Repair Base Difficulty:** -10

A crude and somewhat rudimentary method of enhancing a vehicle's armoured protection, ablative armour often takes the forms of large sections of plasteel welded or in some cases hooked onto exposed areas of a vehicle's sides. These types of modifications add to a vehicle's staying power, but often slow it down due to the excess weight.

Ablative armour adds +4 Armour to each of the vehicle's Facings, but reduces the vehicle's Tactical and Cruising Speed by 5 metres and reduce its Manoeuvrability by -10. Any Critical Damage (including Critical Damage caused by Righteous Fury) to a location that has ablative armour destroys the ablative armour but does not cause any other Critical Effects. Ablative armour cannot be repaired and must be replaced.

## ANTI-GRENADE MESH

**Type:** Standard

**Upgrades:** Any Vehicle

**Install/Repair Base Difficulty:** +10

An uncommon upgrade mostly seen on siege tanks and vehicles expected to face the enemy in close quarters, anti-grenade mesh usually consists of thin metal wiring or heavy plastic rings that have a slight spring when pushed, always returning to their original form. An extremely basic form of passive defence, the mesh tends to deflect incoming grenades, pushing them away before they can explode. Attaching shaped explosives, such as melta bombs, is difficult due to the nonmagnetic nature of the materials used.

Whenever a vehicle with anti-grenade mesh is struck by a grenade, roll 1d10; on a result of 7 or higher, the grenade scatters 1d5 metres away from the tank before detonating. On a result of 1, the Anti-grenade mesh is damaged by the explosion, and ceases to function until repaired. For placed explosives, such as melta bombs, Anti-Grenade Mesh imposes a -20 penalty to any Test to set up the explosive.

## ARTIFICER HULL

**Type:** Integral

**Upgrades:** Any Vehicle

**Install/Repair Base Difficulty:** -40

Engineered by the finest Tech-Priests, the vehicle's hull is a rare work of mechanical art. Thrice blessed by hundreds of chanting Engineeers and anointed in several sacred oils even the thinnest sections of the vehicle's armour can withstand hits that would fell lesser tank in a single hit.

A vehicle with this Upgrade reduces all Critical Damage by 4, gains +10 to any Jink Actions, and suffers no Damage when it initiates a Ram! Action. Due to the sacred nature of the vehicle's hull, all Repair Tests for the vehicle suffer a -20 penalty in addition to any other modifiers.

## CAMO-NETTING

**Type:** Standard

**Upgrades:** Any Vehicle

**Install/Repair Base Difficulty:** +20

Perfect for ambushes or for hiding artillery from enemy aircraft, camo-netting comes in many forms, from actual foliage stripped from trees, to sheets of rock and rubble affixed to light metal frames, and even nets of torn fabric dyed to match the surrounding terrain. camo-netting requires no test to install or remove, and is easily rolled up and stored on the hull of a vehicle. It completely covers a vehicle once installed, and all Tests to spot a camouflaged vehicle suffer a -30 penalty. Camo-netting does not hide a vehicle that is moving or shooting. If a vehicle with camo-netting catches fire, roll 1d10; on a result of 5 or lower, the camo-netting is damaged, and does not function until repaired..

## 'DOZER BLADE

**Type:** Standard

**Upgrades:** Any Tracked Vehicle

**Install/Repair Base Difficulty:** -10

"Dozer blade" is a common term that refers to a family of frontal hull attachments used by many vehicles throughout the Imperium. Most take the form of a large slab of heavy plasteel mounted atop heavy hydraulic shock absorbers, although some are more rigid "ram bars" whereas others have spikes, blades and other dangerous additions. Ostensibly designed to clear rubble and push wrecked vehicles, vehicle crews tend to use them as improvised weapons.

A vehicle with a 'dozer blade increases the Armour of its Front Facing by +4. Additionally a 'dozer blade allows the vehicle to treat terrain with heavy rubble and other detritus as open ground as long as it moves no faster than its Tactical Speed each Turn.

## DISTRIBUTED AMMUNITION STORAGE SYSTEM

**Type:** Integral

**Upgrades:** Any Vehicle with the Enclosed Trait

**Install/Repair Base Difficulty:** -30

Recovered from the crumbling data-crypts of Lathe-Hadd in the Calixis Sector, the distributed ammunition storage system is an ancient method of storing ammunition, specifically explosive shells, in such a way as to limit the damage from ammunition explosions. The distributed ammunition storage system has yet to see widespread use within the Spinward Front as the STC for the device is highly fragmented, but those vehicles lucky enough to have one fear ammunition explosions far less than unprotected vehicles.

Whenever this vehicle suffers Critical Damage to the Weapons Systems or Turret, reduce any Damage the crew would suffer by 10.

## FRAG DEFENDER

**Type:** Standard

**Upgrades:** Any Vehicle with the Enclosed Trait

**Install/Repair Base Difficulty:** -10

A simple but effective modification of the standard smoke launcher, frag defenders explode upwards in a shower of hot shards that patter harmlessly off the tank's hull but are far more lethal to anyone foolish enough to be attacking the tank in melee.

As a Reaction, a vehicle's commander or driver may activate its frag defenders. Each character within 5 metres of the hull of the vehicle suffers 2d10 Explosive Damage with a Penetration of 0 (characters inside of the vehicle and the vehicle itself are unaffected). Frag defenders are single-use items, and must be replaced after each use.

## MINE SWEEPER

**Type:** Standard

**Upgrades:** Any Vehicle with the Tracked Trait

**Install/Repair Base Difficulty:** -10

Mines represent a tremendous threat to armoured vehicles. Often undetectable, mines can lie in place for years before detonating in a colossal explosion that rips through hull plates and crew alike. As there is often no warning of a minefield's presence until it is too late, many tanks fit precautionary "mine sweeper" devices that help detonate scattered mines far in advance of the vehicle's main hull.

Whenever a vehicle equipped with a mine sweeper would trigger a planted explosive, the vehicle's driver may make a **Routine (+20) Perception Test** as a Reaction. If he succeeds, he may have the vehicle back up 5 metres immediately, plus 1 metre per Degree of Success he scored on the Test. If this is enough distance to avoid the explosion, the vehicle suffers no Damage from the detonating mine. Any Critical Damage (including Critical Damage caused by Righteous Fury) to the vehicle's Front Facing damages the Mine Sweeper, rendering it useless until repaired. A vehicle with a minesweeper cannot have a 'dozer blade.

## ROUGH TERRAIN MODIFICATIONS

**Type:** Integral

**Upgrades:** Any Vehicle

**Install/Repair Base Difficulty:** -20

A catch-all term for a number of adaptations, rough terrain modifications give vehicles a greater ability to traverse hazardous terrain. These adaptations include different types of track links, more robust drive wheels, reinforced axles, widely spaced "feet" for walkers and even sophisticated vectored engines for skimmers.

Rough terrain modifications allow a vehicle's driver to re-roll one failed Operate Test per Turn when navigating difficult terrain (see page 272 of the **ONLY WAR** Core Rulebook). Vehicles with the Skimmer Vehicle Trait with this Upgrade increase their Manoeuvrability by +10.

## SEARCHLIGHT

**Type:** Standard

**Upgrades:** Any Vehicle

**Install/Repair Base Difficulty:** +30

Many vehicles mount powerful searchlights in an effort to discover the hidden foes of the Emperor.

Any crew member or passenger can activate a searchlight as a Half Action by making a **Challenging (+0) Perception Test** to find his targets. If he succeeds, he illuminates them. For as long as he keeps the Searchlight active, attacks made against these targets (and against the vehicle) suffer no penalties for darkness.

## SMOKE LAUNCHER

**Type:** Standard

**Upgrades:** Any Vehicle

**Install/Repair Base Difficulty:** +10

A concept that stretches back to ancient Terra, smoke launchers blanket an area in thick impenetrable smoke, shielding vehicles from incoming fire and allowing for hasty retreats or sudden assaults.

As a Half Action or Reaction, the vehicle's commander or driver may trigger its smoke launchers. This creates a cloud of obscuring smoke with a radius of 15 metres, centred on the vehicle (see **Fog, Mist, Shadow, or Smoke** on page 253 of the **ONLY WAR** Core Rulebook). Smoke launchers are single-use items, and must be replaced when expended.

## SUPERIOR PLATING

**Type:** Integral

**Upgrades:** Any Vehicle

**Install/Repair Base Difficulty:** -30

Some vehicles are lucky enough to incorporate rare materials or internal reinforcement within their armour plating, giving them much greater damage resistance than standard armour and certainly more than hastily applied ablative patches.

A vehicle with superior plating gains +2 Armour to all locations and gains the Reinforced Armour Trait. If the vehicle already had this Trait, then the Critical Damage it would suffer is halved again (to a minimum of 1). Superior plating always takes twice as long to repair as regular armour plating.

## TRACK GUARDS

**Type:** Standard

**Upgrades:** Any Vehicle with the Tracked Trait

**Install/Repair Base Difficulty:** +0

Often the most vulnerable point on any armoured vehicle, damaged tracks spell the doom of most tanks. Unable to turn, move or retreat, an immobile tank is an easy target. The Imperial Guard sometimes issues track guards to both its transports and its main battle tanks in an effort to limit track vulnerability. Similar to ablative armour, track guards can be the difference between life and death on the battlefield.

A vehicle with track guards gains +5 Armour against any hits that strike its Motive Systems. Any Critical Damage (including Critical Damage caused by Righteous Fury) to that vehicle's Motive Systems destroys the track guard in that location. Track guards cannot be repaired and must be replaced.

# NEW IMPERIAL GUARD VEHICLES

*"What I cannot crush with words I will crush with the tanks of the Imperial Guard!"*

—Attributed to Lord Commander Solar Macharius

No matter the conditions, the Imperial Guard always has something ready to tackle whatever the galaxy can throw at them. So vast is their armoured might that they possess a tank, transport, walker or artillery piece for any almost conceivable task or obstacle. Now the crushed bones of those heretics and aliens foolish enough to underestimate the fortitude of the Imperial Guard grind helplessly under endless lines of tank tracks.

This section contains a number of new Imperial Guard vehicles. Many of these vehicles have very specialised uses, including defensive platforms and even noncombat recovery and transport vehicles.

## LEMAN RUSS EXTERMINATOR

Although it carries considerably lighter armaments than the standard Leman Russ, the Exterminator is no less heavily armoured than its more common cousin. A simple modification of the Leman Russ design, the Exterminator replaces the battle cannon with a set of autocannons commonly referred to as an exterminator cannon. The higher rate of fire afforded by this weapon system allows the Exterminator to blast through ranks of infantry and lighter vehicles, and the internal space freed up by the removal of the heavy shells gives the Exterminator deep ammunition reservoirs allowing it to operate for longer periods of time without resupply.

The rest of the Exterminator's chassis remains almost identical to that of the venerable Leman Russ, but the robust (if inefficient) engine no longer need cope with the massive weight of the battle cannon and its ammunition, making the Exterminator significantly faster for a vehicle of its type. Often used in a scouting role when armoured companies require recon in force, the Exterminator is reliable, easy to maintain and very dangerous.

Although unsuited to the task, Exterminators can be pressed into ad-hoc anti-aircraft duty when more dedicated AA assets are unavailable. Their main armament is perfect for bringing down enemy fliers, but the Exterminator lacks the sophisticated targeting equipment needed to properly track and eliminate fast-moving airborne targets. Nevertheless squadrons of Exterminators can, at a pinch, mimic the effect of a single Hydra battery.

**Type:** Tracked Vehicle

**Cruising Speed:** 40 kph

**Structural Integrity:** 55

**Armour:** Front 40, Side 32, Rear 20

**Vehicle Traits:** Anti-Air (Rudimentary), Enclosed, Reinforced Armour, Rugged, Tracked Vehicle

**Crew:** 1 Commander (Turret), 1 Driver, 1 Gunner (Turret), 1 Loader/Gunner (Turret/Hull Weapon), 2 additional Gunners (Sponsons; if taken)

**Carrying Capacity:** None

**Tactical Speed:** 14 m

**Manoeuvrability:** -10

**Size:** Massive

## WEAPONS

Turret Mounted exterminator cannon (500m; S/6/-; 3d10+8 I; Pen 6; Clip 120; Reload 2 Full; Reliable, Twin-Linked)

Hull mounted weapon (choose one of the following):

- Heavy bolter (Front Facing; 150m; -/-/6; 1d10+8 X; Pen 5; Clip 60; Reload Full; Tearing)
- Lascannon (Front Facing; S/-/-; 5d10+10 E; Pen 10; Clip 30; Reload 2 Full; Proven [3])
- Heavy flamer (Front Facing; 30m; S/-/-; 1d10+5 E; Pen 4; Clip 20; Reload 2 Full; Flame, Spray)

## OPTIONS

The Exterminator may take two sponson-mounted weapons (choose one of the following):

- 2 heavy bolters (Left Facing/Right Facing; 150m; -/-/6; 1d10+8 X; Pen 5; Clip 60; Reload Full; Tearing)
- 2 heavy flamers (Left Facing/Right Facing; 30m; S/-/-; 1d10+5 E; Pen 4; Clip 20; Reload 2 Full; Flame, Spray)
- 2 plasma cannons (Left Facing/Right Facing; 120m; S/-/-; 2d10+10 E; Pen 8; Clip 32; Reload 5 Full; Blast [1], Maximal, Overheat)

The Exterminator may take one pintle-mounted weapon mounted atop the turret (choose one of the following):

- Heavy stubber (100m; -/-/8; 1d10+4 I; Pen 3; Clip 75; Reload 2 Full)
- Storm bolter (90m; S/2/4; 1d10+5 X; Pen 4; Clip 60; Reload Full; Storm, Tearing)

## SPECIAL RULES

The Exterminator originated from the Forge World of Gryphon IV and vehicles hailing directly from this world tend to have several features not found on more common Exterminator variants. Gryphon IV Exterminators count as having Armour 42 on any hit that strikes the turret, and their recoil suppressors allow the exterminator cannon to ignore the usual penalties for firing whilst moving.



## NEW VEHICLE TRAITS

The new vehicles in this chapter make use of the new Traits below:

### ANTI-AIR (RUDIMENTARY)

The vehicle is sometimes used to shoot down enemy aircraft, although this is not its primary purpose. A vehicle with this Trait halves the standard penalties for ground vehicles firing at aircraft.

### ANTI-AIR (ADVANCED)

The vehicle's primary purpose is to eliminate enemy air assets. A vehicle with this Trait ignores the standard penalties for ground vehicles firing at aircraft.

### SENTRY

The vehicle is controlled not by a living crewman but by some form of machine spirit, logis engine or some other ancient form of technology. A vehicle with the Sentry Vehicle Trait must be set to one of two possible firing modes: Point Defence or Sentry Mode.

- **Point Defence:** The vehicle sits in permanent Overwatch (see page 247 of the **ONLY WAR** Core Rulebook) but with a 90 degree fire arc.
- **Sentry Mode:** In Sentry Mode the vehicle has a specific area of influence (up to half the vehicle's weapon's range set by the one controlling the vehicle) and it may fire in any direction during its Turn. The vehicle rolls for Initiative as per the normal rules for initiative order.

Setting and changing modes on a vehicle with the Sentry Vehicle Trait requires an **Ordinary (+10) Tech-Use Test**. Failure means the machine spirit has not accepted the command and its weapons automatically Jam (but no ammunition is lost). The Jams must be cleared before the Guardsman reattempts the Test.

In addition to setting/changing the vehicles mode, the Guardsman also sets the vehicle's target priority between anti-infantry, anti-tank and anti-air (assuming it is capable of later). The GM has final say in what counts as anti-infantry and anti-tank (eg. Squiggoths, whilst not technically vehicles, could be included in anti-tank whereas Reaver Jetbikes could be categorised as infantry). The vehicle's target priority is set at the time that the vehicle's firing mode is determined.

## LEMAN RUSS EXECUTIONER

The Leman Russ Executioner has all but disappeared from the battlefields of the 41st Millennium. Rarer than even the Leman Russ Vanquisher, the Executioner features a primary weapon that virtually no Forge World can replicate: the plasma destroyer. Volatile, unreliable and devastatingly powerful, this relic of the Age of Technology disgorges gouts of incandescent death that no personal armour can withstand. The plasma destroyer's fusillade makes the Executioner one of the most dangerous tanks available to the Imperial Guard.

However this power comes at a price, and the Executioner has a number of serious drawbacks. Such ancient tech-secrets require dedicated Engineeer support. Prone to massive overheating, the plasma destroyer's troubles only get worse if errant small arms fire or explosive shrapnel cut the external coolant lines. Overtaxed main guns have led to catastrophic detonations, meaning only the most skilled tank crews ever pilot these formidable, if unpredictable, tanks to their full potential.

**Type:** Tracked Vehicle                      **Tactical Speed:** 12 m  
**Cruising Speed:** 35 kph                      **Manoeuvrability:** -10  
**Structural Integrity:** 55                      **Size:** Massive  
**Armour:** Front 40, Side 32, Rear 20

**Vehicle Traits:** Enclosed, Extremely Volatile, Reinforced Armour, Tracked Vehicle

**Crew:** 1 Commander (Turret), 1 Driver, 1 Gunner (Turret), 1 Loader/Gunner (Turret/Hull Weapon), 2 additional Gunners (Sponsons; if taken)

**Carrying Capacity:** None

## WEAPONS

Turret Mounted plasma destroyer (180m; S/3/-; 2d10+12 E; Pen 9; Clip 50; Reload 5 Full; Blast [2], Maximal, Overheat)  
Hull mounted weapon (choose one of the following):

- Heavy bolter (Front Facing; 150m; -/-/6; 1D10+8 X; Pen 5; Clip 60; Reload Full; Tearing)
- Lascannon (Front Facing; 300m; S/-/-; 5d10+10 E; Pen 10; Clip 30; Reload 2 Full; Proven [3])
- Heavy flamer (Front Facing; 30m; S/-/-; 1d10+5 E; Pen 4; Clip 20; Reload 2 Full; Flame, Spray)
- Plasma Cannon (Front Facing; 120m; S/-/-; 2d10+10 E; Pen 8; Clip 32; Reload 5 Full; Blast [1], Maximal, Overheat)

## OPTIONS

The Executioner may take two sponson-mounted weapons (choose one of the following):

- 2 heavy bolters (Left Facing/Right Facing; 150m; -/-/6; 1D10+8 X; Pen 5; Clip 60; Reload Full; Tearing)
- 2 heavy flamers (Left Facing/Right Facing; 30m; S/-/-; 1d10+5 E; Pen 4; Clip 20; Reload 2 Full; Flame, Spray)
- 2 plasma cannons (Left Facing/Right Facing; 120m; S/-/-; 2d10+10 E; Pen 8; Clip 32; Reload 5 Full; Blast [1], Maximal, Overheat)

The Executioner may take one pintle-mounted weapon mounted atop the turret (choose one of the following):

- Heavy stubber (100m; -/-/8; 1d10+4 I; Pen 3; Clip 75; Reload 2 Full)
- Storm bolter (90m; S/2/4; 1d10+5 X; Pen 4; Clip 60; Reload Full; Storm, Tearing)

## HYDRA FLAK TANK

The Hydra Flak Tank is one of the most sought-after vehicles in the Imperial Guard arsenal, and its distinctive silhouette and four long-barrelled autocannons have kept the skies clear of enemy aircraft for millennia. Hydras are usually organised into large anti-aircraft batteries, but individual vehicles regularly find themselves seconded to specific companies where even a single tank can make a huge difference to the unit's defensive capabilities. Artillery companies almost always have attached Hydra support, as they are often the most vulnerable to enemy bombing raids and quick strike aircraft. Infantry units also adore the Hydra, as it can both watch the skies for them as well as point its guns directly forward where the high explosive flak shells can cut enemy infantry to ribbons.

Much like the Manticore, the Hydra features highly sophisticated targeting equipment, and the turret is capable of locking onto a single airborne target and tracking it automatically without the need for manual readjustment by the crew. Combined with its prodigious rate of fire most aircraft that find themselves in a Hydra's sights do not leave in one piece. Deployed by the thousands across the entire Spinward Front, most Hydra crews find their versatile guns pressed into a variety of tasks from standard AA operations, to infantry suppression and even rapid emergency forest clearing. There are few targets they cannot handle, and all Guardsmen feel safer when there's a Hydra or two backing their lines.

**Type:** Tracked Vehicle      **Tactical Speed:** 15 m  
**Cruising Speed:** 50 kph      **Manoeuvrability:** +0  
**Structural Integrity:** 40      **Size:** Massive  
**Armour:** Front 30, Side 18, Rear 16  
**Vehicle Traits:** Anti-Air (Advanced), Enclosed, Tracked Vehicle  
**Crew:** 1 Commander (main gun), 1 Driver, 1 Comms-Operator (Hull Weapon), 1 gunner (main gun), 1 Loader (main gun)  
**Carrying Capacity:** None

## WEAPONS

2 Turret Mounted Hydra autocannons (1500m; S/-/6; 3d10+8 I; Pen 6; Clip 200; Reload 4 Full; Reliable, Tearing, Twin-Linked)  
Hull mounted weapon (choose one of the following):

- Heavy bolter (Front Facing; 150m; -/-/6; 1D10+8 X; Pen 5; Clip 60; Reload Full; Tearing)
- Heavy flamer (Front Facing; 30m; S/-/-; 1d10+5 E; Pen 4; Clip 20; Reload 2 Full; Flame, Spray)

## OPTIONS

The Hydra may take one pintle-mounted weapon mounted at the front of the vehicle (choose one of the following):

- Heavy stubber (100m; -/-/8; 1d10+4 I; Pen 3; Clip 75; Reload 2 Full)
- Storm bolter (90m; S/2/4; 1d10+5 X; Pen 4; Clip 60; Reload Full; Storm, Tearing)

## SPECIAL RULES

Once a Hydra scores a successful hit on an enemy aircraft the Hydra's targeting array automatically begins to track the target and turn the turret to keep the enemy within its sights. As long as a Hydra continues to target the same aircraft all shots from the two Hydra autocannons count as if they had made a Half-Action Aim, therefore gaining a +10 bonus to Ballistic Skill Tests. This bonus is lost as soon as the target is destroyed, the Hydra stops firing at the target, or fires at another target. The bonus never applies to ground targets. Both Hydra autocannons must fire at the same target, and both weapons fire as a single Attack Action.

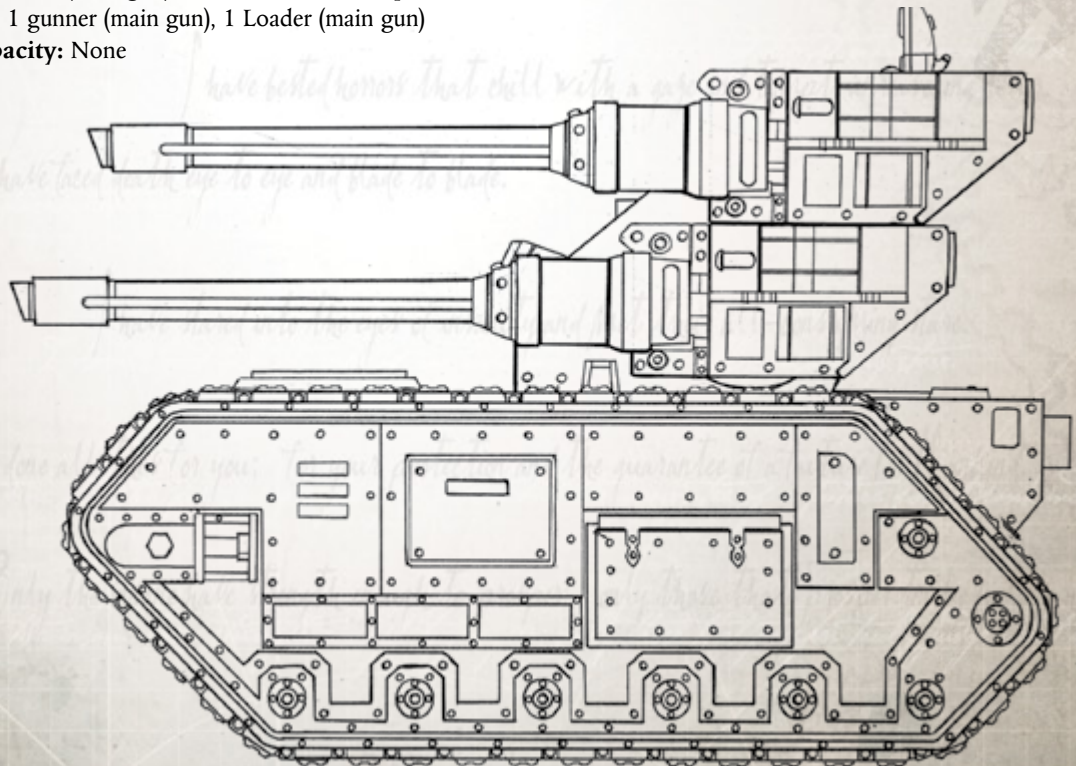

## MANTICORE ROCKET BATTERY

Whilst the Basilisk is the mainstay artillery piece of the Imperial Guard, the Manticore stands above it for sheer destructive firepower. Utilising fairly sophisticated technology by Guard standards the Manticore's four massive rockets—each one nearly the length of the vehicle itself—possess the ability to level massive swathes of infantry, crack open enemy fortifications, or blast enemy aircraft right out of the sky. Typically a Manticore barrage lasts only seconds as the vehicle's high rate of fire quickly overwhelms its limited ammunition capacity. Nevertheless, with secured supply lines, rearming takes little time and it is never long before the crews hear the distinctive sound of another salvo racing into the sky to bring death to the Emperor's foes.

**Type:** Tracked Vehicle      **Tactical Speed:** 16 m  
**Cruising Speed:** 60 kph      **Manoeuvrability:** +0  
**Structural Integrity:** 40      **Size:** Massive

**Armour:** Front 30, Side 18, Rear 16

**Vehicle Traits:** Anti-Air (Advanced)<sup>†</sup>, Enclosed, Tracked Vehicle

**Crew:** 1 Commander (main gun), 1 Driver, 1 Gunner (Hull Weapon), 1 Loader (main gun)

**Carrying Capacity:** None

<sup>†</sup> Only if armed with Sky Eagle Rockets

### WEAPONS

Turret mounted multiple-rocket launcher (4000m; S/2/4; Clip 4; Indirect [4], may fire any ordnance allowed from page 129)

Hull mounted weapon (choose one of the following):

- Heavy bolter (Front Facing; 150m; -/-/6; 1D10+8 X; Pen 5; Clip 60; Reload Full; Tearing)
- Heavy flamer (Front Facing; 30m; S/-/-; 1d10+5 E; Pen 4; Clip 20; Reload 2 Full; Flame, Spray)

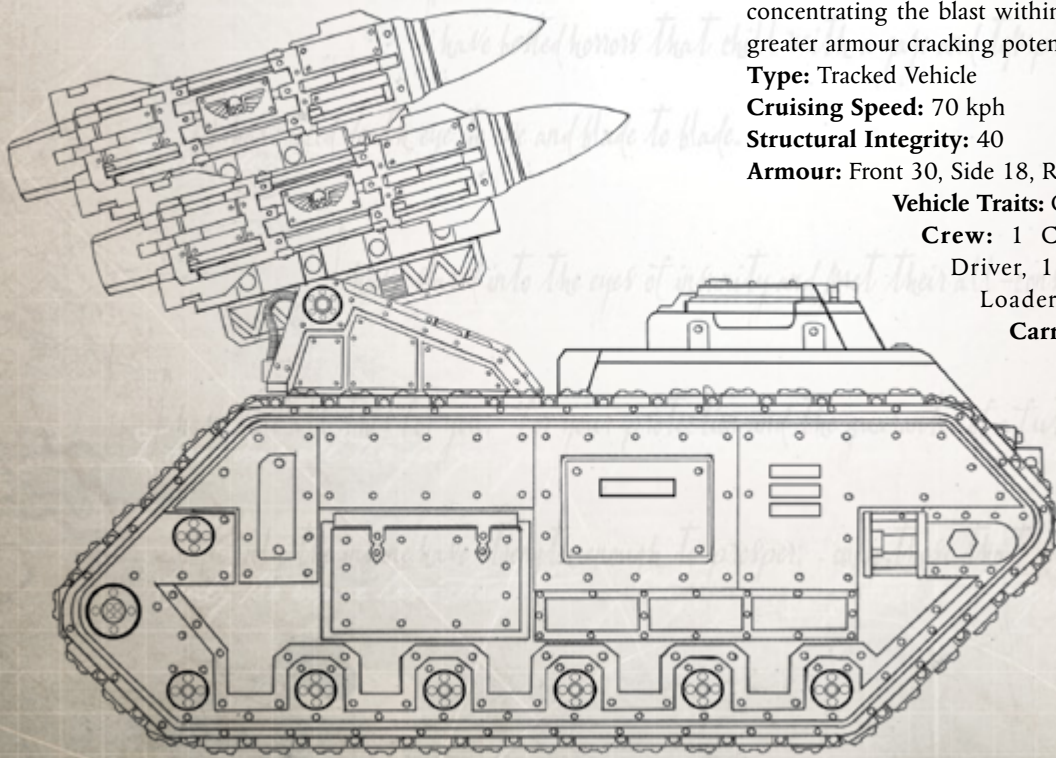

### OPTIONS

The Manticore may take one pintle-mounted weapon mounted at the front of the vehicle (choose one of the following):

- Heavy stubber (100m; -/-/8; 1d10+4 I; Pen 3; Clip 75; Reload 2 Full)
- Storm bolter (90m; S/2/4; 1d10+5 X; Pen 4; Clip 60; Reload Full; Storm, Tearing)

### SPECIAL RULES

A Manticore must select a single type of rocket (see page 129), and all four rockets must be of the same type. Loading a Manticore requires a separate vehicle such as a Trojan Support Vehicle. Reloading the multiple-rocket launcher takes 3 minutes (36 Full Actions) per rocket, and if the Manticore ever suffers a Jam then all the remaining rockets must be manually removed before being replaced. This also takes 3 minutes per rocket and requires a separate support vehicle.

## GRIFFON HEAVY MORTAR

Criticised for its lack of firepower, the Griffon Heavy Mortar is something of a rarity among dedicated artillery regiments. The heavy mortar lacks the punch of its larger cousins such as the earthshaker or bombard, and the heavy mortar's significantly reduced range makes it ill-suited to the task of sustained suppressive barrages. Nevertheless as an infantry close support weapon the Griffon shines above more cumbersome artillery pieces, and as each individual shell tends to be smaller the vehicle's rate of fire is much higher than more traditional barrage weapons. The Griffon's main strength is its versatility, and the heavy mortar is capable of utilising many different shell types. The siege shell is unique to the Griffon, its specialised design allowing it to burrow into the ground before exploding, concentrating the blast within a smaller area and giving it greater armour cracking potential.

**Type:** Tracked Vehicle      **Tactical Speed:** 15 m  
**Cruising Speed:** 70 kph      **Manoeuvrability:** +0  
**Structural Integrity:** 40      **Size:** Massive  
**Armour:** Front 30, Side 18, Rear 16

**Vehicle Traits:** Open-Topped, Tracked Vehicle

**Crew:** 1 Commander (main gun), 1 Driver, 1 Gunner (Hull Weapon), 1 Loader (main gun)

**Carrying Capacity:** None

## WEAPONS

Griffon heavy mortar on a Fixed weapon mounting (300m; S/-/-; Clip 1; Reload Half; Indirect [3], Reliable, may fire any ordnance allowed from page 129)

Hull mounted weapon (choose one of the following):

- Heavy bolter (Front Facing; 150m; -/-/6; 1D10+8 X; Pen 5; Clip 60; Reload Full; Tearing)
- Heavy flamer (Front Facing; 30m; S/-/-; 1d10+5 E; Pen 4; Clip 20; Reload 2 Full; Flame, Spray)

## OPTIONS

The Griffon may take one pintle-mounted weapon mounted at the front of the vehicle (choose one of the following):

- Heavy stubber (100m; -/-/8; 1d10+4 I; Pen 3; Clip 75; Reload 2 Full)
- Storm bolter (90m; S/2/4; 1d10+5 X; Pen 4; Clip 60; Reload Full; Storm, Tearing)

## HADES BREACHING DRILL

Not a true tank by any means, the Hades Breaching Drill is essentially a piece of mining equipment commonly found within combat engineer regiments. Consisting of four diamantine-tipped rotary power cutters and a high-power melta-cutter, the Hades can plough through just about any surface. The Hades is used to grind through massive walls and other obstructions, usually in underground tunnels to guard its crew from enemy fire as it is brought into position. Piloted through man-made, braced tunnels, the Hades acts as the final blow, boring through rockcrete, plasteel, and adamantium with equal ease. This unique ability gives the Hades its role as a subterranean ambush vehicle. With a single command the small vehicle rips into fortified enemy positions from beneath, scattering defenders in a maelstrom of dust and sprays of near-molten rock. Moments later the Hades' attendant combat engineers swarm the breach, securing the position before the enemy has regrouped. Across the Spinward Front the regiments of Krieg make the most use of the Hades, and the small vehicle has a proven track record against the forces of the Severan Dominate. However, against the unpredictable nature of the Orks and nimble raiding parties of the Dark Eldar, the Hades is often of little use.

**Type:** Tracked Vehicle

**Cruising Speed:** 25 kph

**Structural Integrity:** 20

**Armour:** Front 30, Side 16, Rear 16

**Vehicle Traits:** Burrower (6) (see below), Open-Topped, Ponderous, Reinforced Armour, Tracked Vehicle

**Crew:** 1 Driver

**Carrying Capacity:** None

**Tactical Speed:** 10 m

**Manoeuvrability:** -15

**Size:** Enormous

## WEAPONS

Fixed rotary power cutters/melta-cutter (Forward Facing; Melee; 3d10+20 R; Pen 16; Concussive [2], Felling [4], Tearing, Unwieldy)

## SPECIAL RULES

The Hades Breaching Drill can only attack via the Ram! Action (see **ONLY WAR** Core Rulebook page 273), however the Hades uses the weapon profile for the rotary power cutters/melta-cutter to determine the amount of Damage. The Hades takes no Damage from Ram! Actions as they are designed to push through solid rock without slowing down. The Hades Breaching Drill may move underground via the Burrower (6) Trait (see **ONLY WAR** Core Rulebook page 155) leaving behind it a mostly stable tunnel through which infantry can move unhindered and without the need to crouch. Tunnels cut by a Hades are not entirely stable, however, and sometimes collapse. The Hades can attack targets above it whilst it is underground by performing a Ram! Action. Adversaries attacked in this manner are Surprised.

## BANE WOLF CHEM TANK

An exceptionally lethal variant of the Hellhound Flame Tank, the Bane Wolf replaces the inferno cannon with a short ranged chemical spray cannon. Each burst from the chem cannon sends a cloud of toxin so potent that it can melt armour and dissolve flesh. More pervasive than even the best types of promethium, the chem cannon is usually the best weapon for dislodging heavily entrenched infantry. The effects of the toxins are horrifying to behold, and exposed infantry often give the Bane Wolf a wide berth, letting it go about its grizzly work before following up the advance.

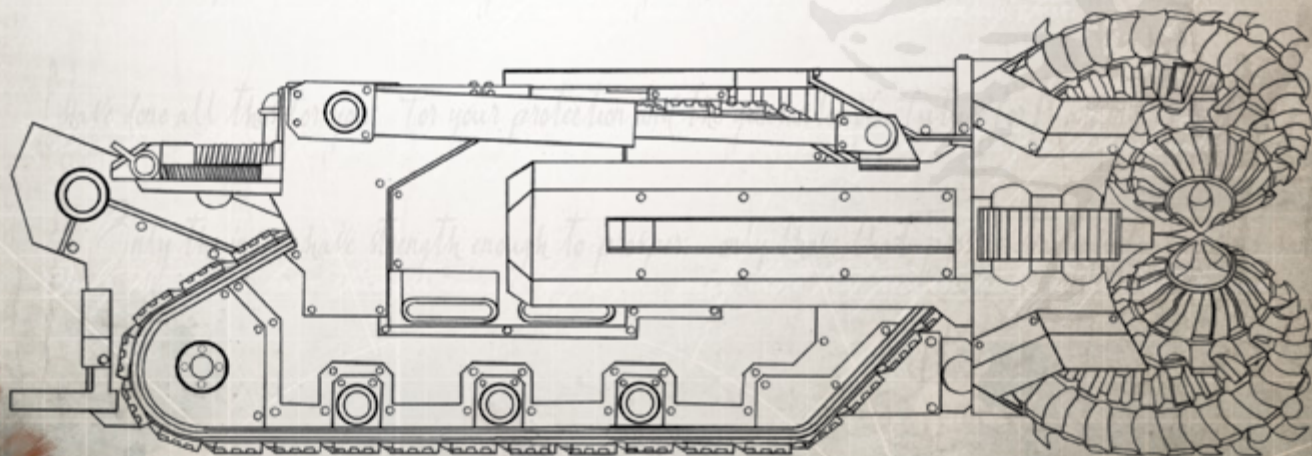

**Type:** Tracked Vehicle  
**Cruising Speed:** 70 kph  
**Structural Integrity:** 30  
**Armour:** Front 30, Side 28, Rear 18  
**Vehicle Traits:** Enclosed, Enhanced Motive Systems, Extremely Volatile, Reinforced Armour, Tracked Vehicle  
**Crew:** 1 Commander (main gun), 1 Driver, 1 Gunner (Hull Weapon)  
**Carrying Capacity:** None

**Tactical Speed:** 18 m  
**Manoeuvrability:** +10  
**Size:** Massive

## WEAPONS

Turret mounted chem cannon (40m; S/-/-; 2d10+5 E; Pen 9; Clip 100; Reload Full; Crippling [2], Felling [2], Spray, Toxic [4])

Hull mounted weapon (choose one of the following):

- Heavy bolter (Front Facing; 150m; -/-/6; 1D10+8 X; Pen 5; Clip 60; Reload Full; Tearing)
- Heavy flamer (Front Facing; 30m; S/-/-; 1d10+5 E; Pen 4; Clip 20; Reload 2 Full; Flame, Spray)

## OPTIONS

The Bane Wolf may take one pintle-mounted weapon mounted atop the turret (choose one of the following):

- Heavy stubber (100m; -/-/8; 1d10+4 I; Pen 3; Clip 75; Reload 2 Full)
- Storm bolter (90m; S/2/4; 1d10+5 X; Pen 4; Clip 60; Reload Full; Storm, Tearing)

## SPECIAL RULES

Bane Wolves that rupture in combat do more than simply explode, leaving a billowing cloud of toxic gas that lingers for some time. The Bane Wolf has the Extremely Volatile Vehicle Trait as listed above. However if the Bane Wolf explodes replace the Test to catch fire with a single hit that has the Toxic (3) Special Quality. The gas cloud lingers for 1d5 rounds, and anyone who stays within the cloud suffers another hit each Round and gains the Suffocation Special Damage Condition (see page 267 of the **ONLY WAR** Core Rulebook) until they leave the cloud or the cloud dissipates.

# SALAMANDER RECONNAISSANCE VEHICLE

Mostly seen in pairs ranging ahead of Imperial lines, the Salamander Reconnaissance Vehicle is a lightly armed and armoured variant of the Chimera chassis. Used in a similar role to the Sentinel, Salamanders use their high speed to move beyond the main advance and identify important targets. Outside of reconnaissance, Salamanders act as sentries and guards for supply depots where their thin armour and limited armaments make them less of a liability. Crews are trained to withdraw to friendly lines rather than engage in pitched battles as the Salamander is neither designed for nor capable of protracted engagements. Capable of covering more terrain types at a greater rate than their walker cousins, Salamanders give Imperial Guard commanders a real edge when scouting uneven ground.

**Type:** Tracked Vehicle  
**Cruising Speed:** 100 kph  
**Structural Integrity:** 35

**Tactical Speed:** 20 m  
**Manoeuvrability:** +10  
**Size:** Massive

**Armour:** Front 30, Side 18, Rear 16

**Vehicle Traits:** Amphibious, Enhanced Motive Systems, Open-Topped, Tracked Vehicle

**Crew:** 1 Commander (main gun), 1 Driver, 1 Comms-Operator, 1 Gunner (Hull Weapon)

**Carrying Capacity:** None

## WEAPONS

Fixed autocannon (Front Facing; 300m; S/3/-; 3d10+8 I; Pen 6; Clip 200; Reload 2 Full; Ogryn-Proof, Reliable)

Hull mounted weapon (choose one of the following):

- Heavy bolter (Front Facing; 150m; -/-/6; 1D10+8 X; Pen 5; Clip 60; Reload Full; Tearing)
- Heavy flamer (Front Facing; 30m; S/-/-; 1d10+5 E; Pen 4; Clip 20; Reload 2 Full; Flame, Spray)

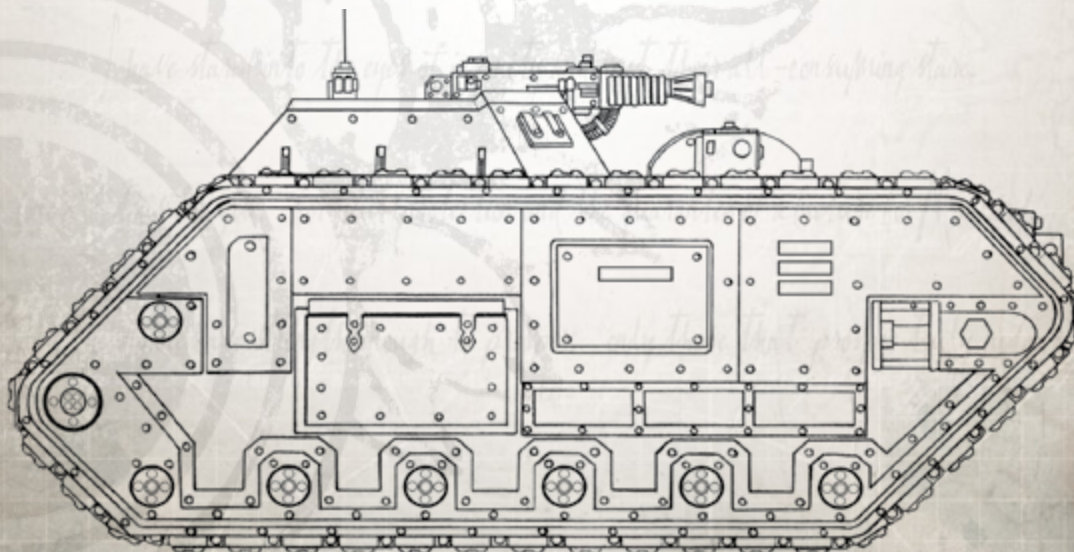

## SALAMANDER COMMAND VEHICLE

An even more specialised variant of the Chimera chassis, the Salamander Command Vehicle often finds itself at the head of Armoured Fist Companies and artillery batteries where it can act as a spotter and coordinate the actions of its fellow vehicles. Not designed for combat and equipped with only the most cursory of defensive weaponry, the Salamander's chief strength lies in its multi-spectral auspex surveyor. The device gives the Salamander's crew a commanding view of the battlefield allowing for better organisation and a more fluid response to enemy movements. Unfortunately for the forces of the Spinward Front, the Severan Dominate makes extensive use of the Salamander Command Vehicle, and its sophisticated command and control features have led to numerous crushing defeats on many worlds.

**Type:** Tracked Vehicle      **Tactical Speed:** 15 m  
**Cruising Speed:** 70 kph      **Manoeuvrability:** +0  
**Structural Integrity:** 35      **Size:** Massive  
**Armour:** Front 30, Side 18, Rear 16  
**Vehicle Traits:** Amphibious, Improved Command and Control, Open-Topped, Tracked Vehicle  
**Crew:** 1 Commander (main gun), 1 Driver, 1 Comms-Operator, 1 Gunner (Hull Weapon)  
**Carrying Capacity:** None

### WEAPONS

Fixed weapon mount (choose one of the following):

- Heavy bolter (Front Facing; 150m; -/-/6; 1D10+8 X; Pen 5; Clip 60; Reload Full; Tearing)
- Heavy flamer (Front Facing; 30m; S/-/-; 1d10+5 E; Pen 4; Clip 20; Reload 2 Full; Flame, Spray)

Hull mounted weapon (choose one of the following):

- Heavy bolter (Front Facing; 150m; -/-/6; 1D10+8 X; Pen 5; Clip 60; Reload Full; Tearing)
- Heavy flamer (Front Facing; 30m; S/-/-; 1d10+5 E; Pen 4; Clip 20; Reload 2 Full; Flame, Spray)

### OPTIONS

The Salamander Command Vehicle may take one pintle-mounted weapon mounted at the front of the vehicle (choose one of the following):

- Heavy stubber (100m; -/-/8; 1d10+4 I; Pen 3; Clip 75; Reload 2 Full)
- Storm bolter (90m; S/2/4; 1d10+5 X; Pen 4; Clip 60; Reload Full; Storm, Tearing)

### SPECIAL RULES

The Salamander incorporates a multi-spectral auspex surveyor, accessible to the driver. This system is capable of scanning for energy emissions, motion, as well as signs of biological life. Due to the vehicle's energy sources and the surveyor's additional inputs, the device has a greater effective range and sensitivity than standard auspexes. A character using the surveyor gains a +30 bonus to Awareness Tests, and may make an **Ordinary (+10) Tech-Use** Test to detect things not normally possible with human senses, such as invisible gases, nearby signs of life, non-visible radiation, and so on. The standard range for a surveyor is 500m, though walls more than 1 m thick and certain shielding materials block the scanner.

## TAUROS ASSAULT VEHICLE

An all-terrain vehicle found mostly in use by Elysian regiments, the Tauros Assault Vehicle's compact design and sophisticated drive system make it a remarkable asset to regiments that lack traditional armoured support. Featuring a silent-running long-ranged electric engine and set of special galvanic motors that powers each wheel individually the Tauros is very hard to stop, and can still maintain considerable speeds even when half of its wheels are damaged or destroyed. Limited weapons and negligible armour make the Tauros unsuitable for frontal attacks, but the speed and reliability of its motive systems make it a great harassing unit and an excellent scout vehicle.

**Type:** Wheeled Vehicle      **Tactical Speed:** 20 m  
**Cruising Speed:** 120 kph      **Manoeuvrability:** +15  
**Structural Integrity:** 20      **Size:** Enormous  
**Armour:** Front 16, Side 14, Rear 14  
**Vehicle Traits:** Enhanced Motive Systems, Open-Topped, Rugged, Wheeled Vehicle  
**Crew:** 1 Driver, 1 Gunner  
**Carrying Capacity:** None

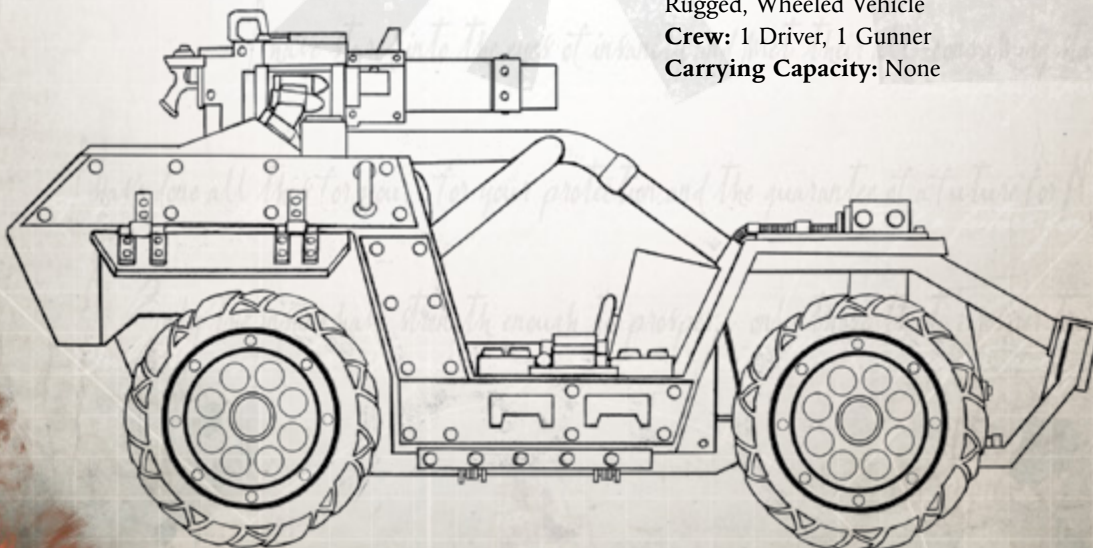

## WEAPONS

Pintle-mounted weapon (choose one of the following):

- Heavy flamer (30m; S/-/-; 1d10+5 E; Pen 4; Clip 20; Reload 2 Full; Flame, Spray)
- Tauros grenade launcher (90m; S/2/-; Clip 20; Reload 2 Full; Damage/Damage Type/Penetration depends on the type of grenade)

## SPECIAL RULES

Although it is a Wheeled Vehicle, Tauros Assault Vehicles are treated as Tracked Vehicles for the purposes of Tests involving Difficult Terrain and when determining how much slower they get when suffering critical damage. Additionally they ignore the usual penalties to Operate Tests that Wheeled Vehicles normally suffer when taking Motive Systems Damage.

## TAUROS VENATOR

A further modification of the Tauros Assault Vehicle, the Venator is larger and more heavily armed, featuring a powered turret and an additional set of independently powered wheels. The increased size also allows for slightly thicker frontal armour, making the Venator capable of withstanding more punishment whilst engaging in flanking or hit and fade attacks. Designed to give Elysian regiments a form of fast-moving heavy weapon support, the Venator's turret and missile hard points allow it to excel at both anti-infantry and anti-tank duty.

**Type:** Wheeled Vehicle                      **Tactical Speed:** 20 m  
**Cruising Speed:** 110 kph                      **Manoeuvrability:** +10  
**Structural Integrity:** 25                      **Size:** Enormous  
**Armour:** Front 18, Side 15, Rear 15  
**Vehicle Traits:** Enhanced Motive Systems, Open-Topped, Rugged, Wheeled Vehicle  
**Crew:** 1 Driver (hunter-killer missiles), 1 Gunner (turret)  
**Carrying Capacity:** None

## WEAPONS

Turret-mounted weapon (choose one of the following):

- Twin-linked multi-lasers (150m; -/-/5; 2d10+10 E; Pen 2; Clip 400; Reload 2 Full; Reliable, Twin-Linked)

- Twin-linked lascannons (300m; S/-/-; 5d10+10 E; Pen 10; Clip 30; Reload 2 Full; Proven [3])

Two Fixed hunter-killer missiles (Front Facing; 350m; S/-/-; 3d10+6 X; Pen 6; Clip 1)

## SPECIAL RULES

The Venator follows the same special rules for its motive systems as the Tauros Assault Vehicle.

## ATLAS RECOVERY VEHICLE

The Atlas is a heavily stripped down variant of the Lemn Russ used for towing immobilised or damaged vehicles to safety. The Atlas' engine is powerful enough to tow a fully-loaded Lemn Russ, and can even tow something as large as a Baneblade when matched with three or four other recovery vehicles. The Atlas performs its tasks by means of its heavy duty winch and hydraulic spade, both of which allow the Atlas to stay steady during recovery operations and pull even the most crippled vehicles from ditches or craters. Atlas Recovery Vehicles also assist with field repairs as their ability to lift stricken vehicles gives Engineers the chance to restore what would normally require a full repair facility. With no turret and little armour to speak of, the Atlas is extremely vulnerable to enemy attack and thus tends to wait in reserve until called upon.

**Type:** Tracked Vehicle                      **Tactical Speed:** 14 m  
**Cruising Speed:** 40 kph                      **Manoeuvrability:** -10  
**Structural Integrity:** 35                      **Size:** Massive  
**Armour:** Front 28, Side 18, Rear 16  
**Vehicle Traits:** Enclosed, Rugged, Tracked Vehicle  
**Crew:** 1 Commander (Hull Weapon), 1 Driver, 1 Operator (heavy duty winch)  
**Carrying Capacity:** None

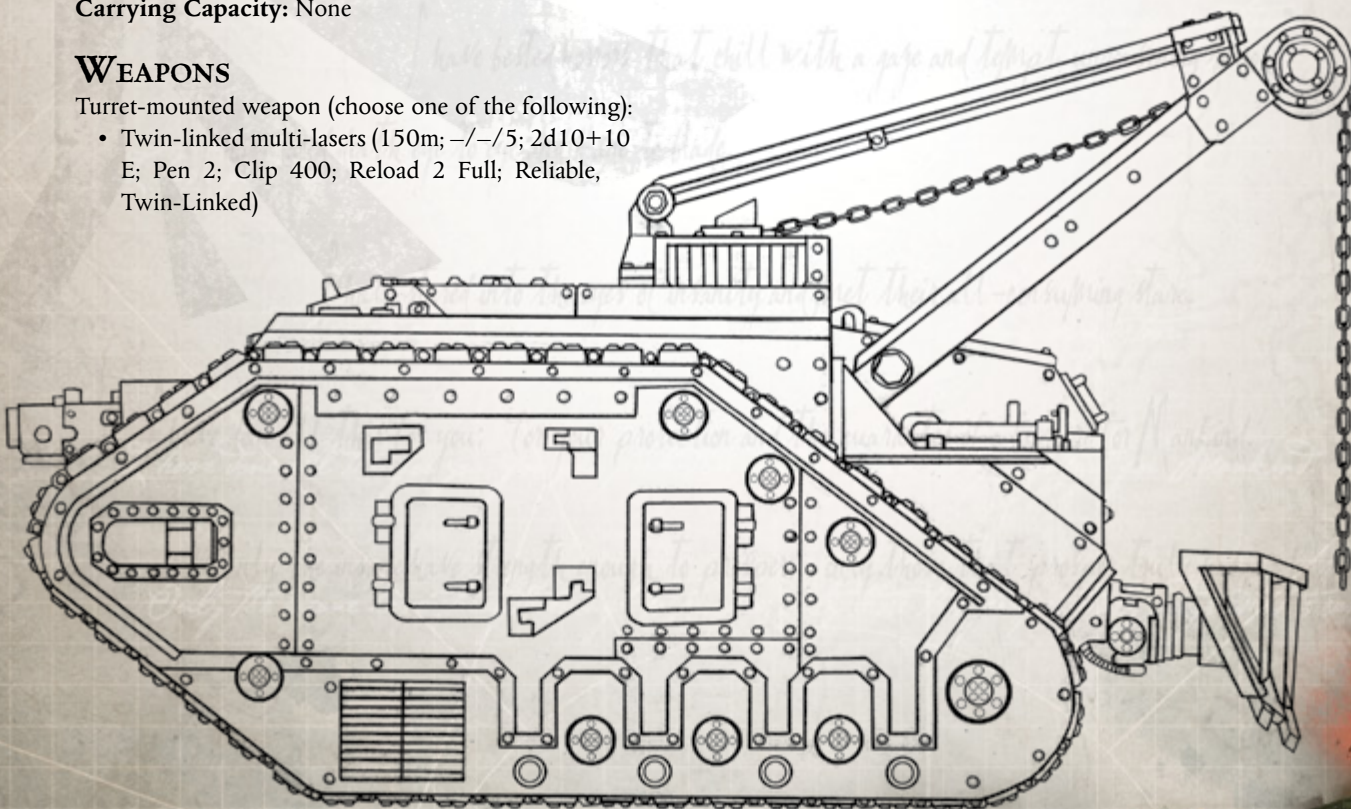

## WEAPONS

Hull mounted weapon (choose one of the following):

- Heavy bolter (Front Facing; 150m; -/-/6; 1D10+8 X; Pen 5; Clip 60; Reload Full; Tearing)
- Heavy flamer (Front Facing; 30m; S/-/-; 1d10+5 E; Pen 4; Clip 20; Reload 2 Full; Flame, Spray)

## OPTIONS

The Atlas Recovery Vehicle may take one pintle-mounted weapon mounted at the front of the vehicle (choose one of the following):

- Heavy stubber (100m; -/-/8; 1d10+4 I; Pen 3; Clip 75; Reload 2 Full)
- Storm bolter (90m; S/2/4; 1d10+5 X; Pen 4; Clip 60; Reload Full; Storm, Tearing)

## SPECIAL RULES

Atlas Recovery Vehicles may tow a single vehicle up to Massive in size. It requires two Atlas Recovery Vehicles to tow a vehicle of size Immense, and four to tow Monumental or larger vehicles. In all instances towing another vehicle halves the Atlas' Tactical and Cruising Speed and reduces its Manoeuvrability to -20. Winching a vehicle into position takes 2 minute (24 Full Actions) and the Atlas must remain stationary whilst this process is completed. If used for field repairs, the presence of an Atlas lifting a vehicle into a better position for repairs decreases the difficulty of the Repair Test by +10 (eg. a **Hard (-20) Repair Test** becomes a **Difficult (-10) Repair Test**). Hits to the vehicle's rear that also strike the Weapon Location hit the heavy-duty winch (count ammunition explosions as the winch's power source exploding). The heavy-duty winch is treated like any other weapon for the purposes of Critical Damage, repairing and replacement, so a Weapon Disabled Damage Condition means the winch cannot be used until repaired or replaced.

## CENTAUR CARRIER

Easily one of the smallest vehicles employed by the Imperial Guard, the Centaur Carrier is an exceptionally versatile vehicle that uses speed and a uniquely modular design to fulfil a number of roles. Centaurs act as command crew transports, supply transports and communication vehicles, but they most often find use as towing vehicles for field artillery as well as transporting the gun crews that operate these weapons. The Centaur itself has few weapons, often just a single pintle mount, but its hull incorporates a modular weapon mount adapted for numerous weapon types. This makes it an ideal transport for small units of well-equipped infantry, such as Storm Troopers or Grenadiers. Not considered fighting vehicles, Centaur crews tend to fall back from concentrated pockets of enemy resistance using their high speed to get away quickly.

**Type:** Tracked Vehicle

**Cruising Speed:** 110 kph

**Structural Integrity:** 25

**Armour:** Front 25, Side 16, Rear 12

**Vehicle Traits:** Enhanced Motive Systems, Open-Topped, Rugged, Tracked Vehicle

**Crew:** 1 Driver, 1 Gunner (pintle-mount)

**Carrying Capacity:** 5 Imperial Guardsmen plus wargear.

**Tactical Speed:** 20 m

**Manoeuvrability:** +10

**Size:** Enormous

## WEAPONS

Heavy Stubber (Pintle Mount; 100m; -/-/8; 1d10+4 I; Pen 3; Clip 75; Reload 2 Full)

## SPECIAL RULES

The Centaur Carrier's modular weapon mount is large enough to accept a single heavy stubber, heavy flamer or grenade launcher, assuming the transported passengers have such a weapon. The weapon must be fired by the passengers. Weapons mounted in this manner count as being Fixed weapons with a Forward Facing, and are automatically considered Braced. Centaurs may tow field artillery pieces up to Massive in size, although this halves their Tactical and Cruising Speed and reduces their Manoeuvrability to -10. Limbering and unlimbering a piece of field artillery takes 1 minute (12 Full Actions) and the Centaur must remain stationary whilst this process is completed.

## CYCLOPS DEMOLITION VEHICLE

A diminutive vehicle that none would ever describe as a "tank," the Cyclops Demolition Vehicle is a remote-controlled siege weapon packed with an inordinate amount of high explosives. Upon command the Cyclops detonates with a thunderous crack, ripping apart fortifications and annihilating exposed infantry over a large area. However against the heavily entrenched forces of the Severan Dominate, the Cyclops more often find itself deployed for mine and tank trap clearance despite its overwhelming explosive power. The small size of the Cyclops allows it to fit inside the hulls of Chimeras, Crassus Armoured Assault Transports and even Valkyries. Always in high demand and low supply, the Cyclops holds a special place in many Spinward Front regiments.

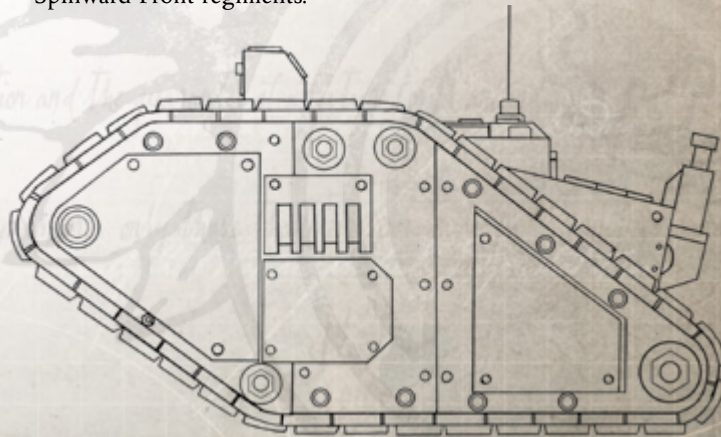

**Type:** Tracked Vehicle  
**Cruising Speed:** 42 kph  
**Structural Integrity:** 10  
**Armour:** Front 10, Side 10, Rear 8  
**Vehicle Traits:** Enclosed, Extremely Volatile, Ponderous, Tracked Vehicle  
**Crew:** None (see below)  
**Carrying Capacity:** None

**Tactical Speed:** 12 m  
**Manoeuvrability:** -10  
**Size:** Average

## WEAPONS

Cyclops demolition charge (4d10+10 X; Pen 8; Blast [1d10+10], Concussive [5], Special [see below])

## SPECIAL RULES

The Cyclops is too small to be driven or ridden. Instead, each Guardsman controller is assigned a special remote control device. The Guardsman must be trained in Tech-Use to use the remote control device, and the device itself weighs 1kg and requires both hands to operate. The remote control has an effective range of 200 metres, although walls above 1m thick and inclement weather can reduce this range. The Cyclops cannot move without input from the controlling Guardsman, and the Guardsman must split his Actions between himself and the Cyclops. Detonating the Cyclops' demolition charge is a Half Action with the Attack and Concentration subtypes. Once detonated the Cyclops is automatically destroyed and cannot be repaired or salvaged. Cyclops Demolition Vehicles automatically detonate if they suffer Righteous Fury. If a Cyclops ever explodes due to accumulated Critical Damage use the Damage profile for the demolition charge rather than the standard Damage for exploding vehicles. A Cyclops Demolition Vehicle takes up the equivalent space of 5 Guardsmen (so a Chimera could carry two Cyclops Demolition Vehicles and the two Guardsmen that control them) although due to their weight a Valkyrie can only ever carry a single Cyclops.

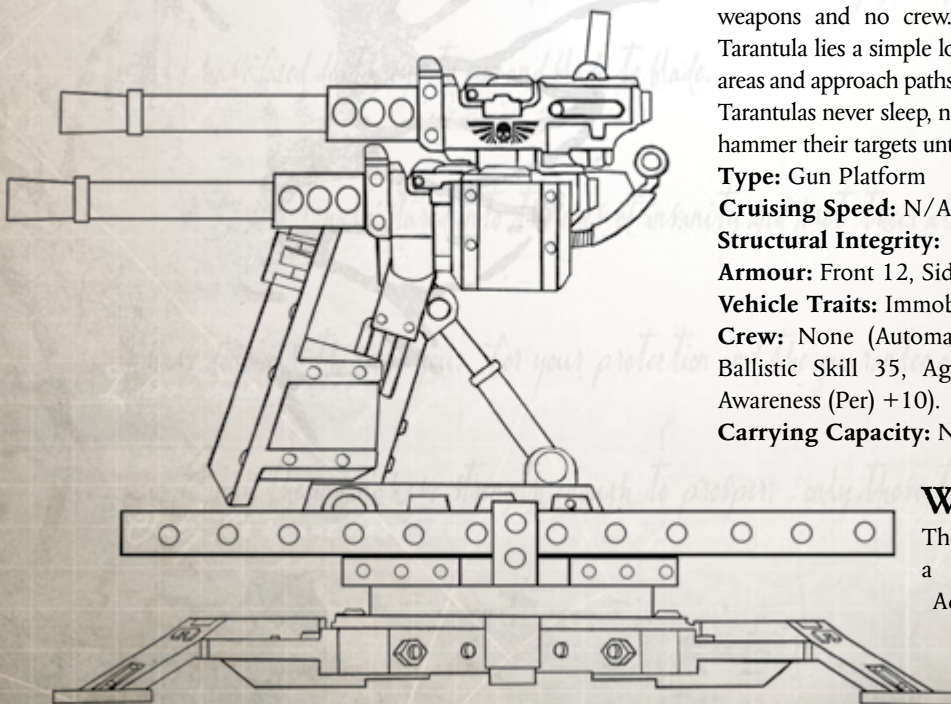

## SABRE GUN PLATFORM

Sabre Gun Platforms are simple and relatively robust point defence weapons often used as a light support weapon or as a way of shoring up strong points with additional firepower. Consisting of paired heavy weapons and designed with a single operator in mind, the Sabre's simple yet elegant gyroscopic frame provides ample range of movement for both anti-ground and anti-air targeting.

**Type:** Gun Platform  
**Cruising Speed:** N/A  
**Structural Integrity:** 14  
**Armour:** Front 12, Side 10, Rear 8  
**Vehicle Traits:** Anti-Air (Rudimentary), Immobile, Open-Topped, Rugged  
**Crew:** 1 Gunner  
**Carrying Capacity:** None

**Tactical Speed:** N/A  
**Manoeuvrability:** +0  
**Size:** Hulking

## WEAPONS

Turret mounted weapon (choose one of the following):

- Twin-linked heavy bolter (150m; -/-/6; 1D10+8 X; Pen 5; Clip 240; Reload Full; Tearing, Twin-Linked)
- 2 Twin-linked heavy stubbers† (100m; -/-/8; 1d10+4 I; Pen 3; Clip 300; Reload 2 Full, Twin-Linked)
- Twin-linked lascannon (300m; S/-/-; 5d10+10 E; Pen 10; Clip 80; Reload 2 Full; Proven [3], Twin-Linked)
- Twin-linked autocannon (300m; S/3/-; 3d10+8 I; Pen 6; Clip 120; Reload 2 Full; Ogryn-Proof, Reliable, Twin-Linked)

† Must be fired at the same target as part of the same Attack Action.

## TARANTULA SENTRY GUN

The Tarantula Sentry Gun comes from an ancient design lost to the vagaries of time. Found throughout the Imperium, the Tarantula is a short multi-legged turret that features two heavy weapons and no crew. Within the armoured shell of each Tarantula lies a simple logis engine capable of guarding defined areas and approach paths far more effectively than living sentries. Tarantulas never sleep, never waver in their duty and relentlessly hammer their targets until their ammunition bays run dry.

**Type:** Gun Platform  
**Cruising Speed:** N/A  
**Structural Integrity:** 12  
**Armour:** Front 12, Side 10, Rear 10  
**Vehicle Traits:** Immobile, Enclosed, Sentry  
**Crew:** None (Automated Logis Engine assumed to have Ballistic Skill 35, Agility 40, Perception 35 as well as Awareness (Per) +10).  
**Carrying Capacity:** None

**Tactical Speed:** N/A  
**Manoeuvrability:** +0  
**Size:** Hulking

## WEAPONS

The Tarantula is assumed to have a Preysense Sight and a Targeter. Additionally the Tarantula has one turret mounted weapon (choose one of the following):

- Twin-linked heavy bolter (150m; --/6; 1D10+8 X; Pen 5; Clip 600; Reload Full; Tearing, Twin-Linked)
- Twin-linked lascannon (300m; S/--/; 5d10+10 E; Pen 10; Clip 100; Reload 2 Full; Proven [3], Twin-Linked)

### SPECIAL RULES

The rules here represent the more common Metalica-pattern Tarantula, however if the players wish they may instead use a Hadd-pattern Tarantula. Found only within the Calixis Sector, this peculiar pattern of Tarantula lacks the automated features of standard Tarantulas but has a wider selection of weaponry. The Hadd-pattern Tarantula loses the Sentry Vehicle Trait and requires a single Guardsman trained in Tech-Use to control it via a special targeting interface device. The device weighs 1kg, requires both hands to operate and has an effective range of 200 metres, although walls greater than a metre thick and inclement weather can reduce this range. The Guardsman must split his Actions between himself and the Tarantula. Additionally the Hadd-pattern Tarantula may choose one of the following weapons instead of the standard weapon options:

- Twin-linked multi-lasers (150m; --/5; 1D10+10 E; Pen 2; Clip 120; Reload 2 Full; Reliable, Twin-Linked)
- Twin-linked plasma cannons (120m; S/--/; 2d10+10 E; Pen 8; Clip 48; Reload 5 Full; Blast [1], Maximal, Overheat, Twin-Linked)
- Twin-linked multi-meltas (60m; S/--/; 2d10+16 E; Pen 12; Clip 24; Reload Full; Blast [1], Melta, Twin-Linked)

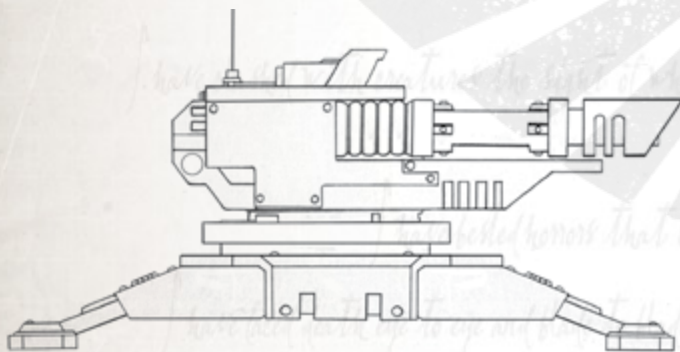

## SHADOWSWORD

Sister tank to the Baneblade, the Shadowsword's formidable frame is home to the mighty Volcano Cannon, a Titan-killing weapon capable of punching through massed void shields and sheering titan-sized limbs off in a single blast.

As one of the largest non-starship-based weapons in the Imperial arsenal, the Volcano Cannon is a sight to behold on the battlefield. Each lance of white-blue energy that leaps from its barrel blinds any foolish enough to look directly upon it, and seconds later whatever the Shadowsword targeted is often reduced to a massive smoking crater. The weapon is overkill in most instances, but as most Shadowwords hail from worlds that maintain their own Titan Legions, the Shadowwords act as additional anti-Titan firepower, working as hunter-killer tanks that enemy titans tend to neglect in favour of larger targets. This is useful as the gun must recharge after each shot, leaving the Shadowsword stationary and temporarily vulnerable to counter-attack.

**Type:** Tracked Vehicle

**Cruising Speed:** 25 kph

**Structural Integrity:** 120

**Armour:** Front 48, Side 40, Rear 30

**Vehicle Traits:** Command and Control, Damage Control, Enclosed, Ponderous, Reinforced Armour, Super-Heavy, Tracked Vehicle

**Crew:** 1 Commander (Turret), 1 Driver, 4 gunners (Volcano cannon/Hull-mounted heavy bolter/both sponsons). Shadowwords usually have a dedicated comms-operator and almost always have an Engineeer as part of their crew

**Carrying Capacity:** None

**Tactical Speed:** 8 m

**Manoeuvrability:** -30

**Size:** Monumental

### WEAPONS

Fixed volcano cannon (Front Facing, 3000m; S/6/--; 3d10+8 I; Pen 6; Clip 120; Reload 2 Full; Reliable, Twin-Linked)

Fixed twin-linked heavy bolter (Front Facing; 150m; --/6; 1D10+8 X; Pen 5; Clip 60; Reload Full; Tearing, Twin-Linked)

2 Sponson-mounted twin-linked heavy bolters (Left Facing/Right Facing; 150m; --/6; 1D10+8 X; Pen 5; Clip 60; Reload Full; Tearing, Twin-Linked)

2 Turret-mounted lascannons (300m; S/--/; 5d10+10 E; Pen 10; Clip 30; Reload 2 Full; Proven [3])

### OPTIONS

The Shadowsword may take one pintle-mounted weapon mounted atop the vehicle (choose one of the following):

- Heavy stubber (100m; --/8; 1d10+4 I; Pen 3; Clip 75; Reload 2 Full)
- Storm bolter (90m; S/2/4; 1d10+5 X; Pen 4; Clip 60; Reload Full; Storm, Tearing)

### SPECIAL RULES

Shadowwords have weapon mountings across their entire hull. To further clarify the weapons listed above, each of the turret mounted lascannons are located on top of the sponson mounted twin-linked heavy bolters, and the fixed twin-linked heavy bolter is mounted far forward on the Shadowsword's hull. Remember that whilst turrets have a 360-degree Fire Arc, the vehicle itself can block this Arc, and this can limit the smaller turrets' Fire Arcs. Additionally the sophisticated machine spirits slaved to the Shadowsword's Lascannons mean they can be fired at the same time and at different targets as the vehicle's sponson-mounted twin-linked heavy bolters by the same gunner as a Full Action.

At the GM's discretion a Shadowsword may be given the Environmentally Sealed Vehicle Trait and, to represent the older and more sophisticated sponsons, each turret-mounted Lascannon may be replaced with an advanced Logis Engine (Ballistic Skill 35, Agility 40, Perception 35, with Awareness (Per) +10, a Preysense Sight and a Targeter) that gives the Shadowsword the Sentry Vehicle Trait (but only for the sponsons). If an Engineeer is part of a Shadowsword's crew its own Damage Control systems are enhanced. In these instances the vehicle's Reinforced Armour Vehicle Trait counts against Righteous Fury rolls and all Tests to put out fires gain a +20 bonus.